

# Hydrocarbon Hotspots in the Urban Landscape: Can They Be Controlled?

**T**wo central paradigms emerged from the EPA's Nationwide Urban Runoff Study in the early 1980s. One was that pollutant concentrations in urban runoff were more or less the same regardless of the contributing land use. The second was that urban runoff carried relatively few priority pollutants, most of which were metals.

Subsequent monitoring has generally reinforced both paradigms, particularly for conventional pollutants such as sediments, nutrients, and organic carbon. However, two recent research studies suggest that there may be major exceptions to these paradigms. The studies point to the existence of *hotspots* in the urban landscape that produce significantly greater loadings of hydrocarbons and trace metals than other areas.

Hotspots are often linked to places where vehicles are fueled and serviced, such as gas stations, bus depots, and vehicle maintenance areas. Others occur where many vehicles are parked for brief periods during the day (convenience stores and fast food outlets), or where large numbers of vehicles are parked for a long time (commuter parking lots).

Hotspots are evident in the data of Schueler and Shepp (1992). Their survey of oil and grit separators in suburban Maryland show the differences in the quality of pool water and trapped sediments in separators draining five different paved areas (Table 1). Gas stations and convenience stores had much higher levels of hydrocarbons and metals both in the water column and the sediments. Streets and residential parking lots, on the other hand, had much lower hydrocarbon and metal concentrations.

Gas stations were found to be an extremely significant hotspot for hydrocarbons. Composite priority pollutant scans at the gas station sites revealed the presence of 37 potentially toxic compounds in the sediment and 19 in the water column. Many compounds were polycyclic aromatic hydrocarbons (PAHs) that are thought to be harmful to both humans and aquatic organisms (Table 2). Non-gas station sites, on the other hand, recorded far fewer priority pollutants that had much lower concentrations.

Pitt and Field (1991) monitored metal and PAH levels in runoff from a number of sites in Mobile,

**Table 1: Sediment and Pool Water Quality Found in Oil Grit Separators at Various Urban Locations (Schueler and Shepp, 1992)**

Parameter	Gas Stations	Convenience Stores	All-Day Parking Lots	Streets	Residential Parking
<b>Comparative Sediment Quality (reported in mg/kg of sediment)</b>					
Total P	1,056	1,020	466	365	267
TOC	98,071	55,167	37,915	33,025	32,392
Hydrocarbons	18,155	7,003	7,114	3,482	892
Cadmium	35.6	17.0	13.2	13.6	13.5
Chromium	350	233	258	291	323
Copper	788	326	186	173	162
Lead	1,183	677	309	544	180
Zinc	6,785	4,025	1,580	1,800	878
<b>Comparative Pool Water Quality (reported in µg/l)</b>					
Total P*	0.53	0.50	0.30	0.06	0.19
TOC*	95.51	26.8	20.6	9.9	15.8
HC*	22.0	10.9	15.4	2.9	2.4
Cadmium	15.3	7.9	6.5	ND	ND
Chromium	17.6	13.9	5.4	5.5	ND
Copper	112.6	22.1	11.6	9.5	3.6
Lead	162.4	28.8	13.0	8.2	ND
Zinc	554	201	190	92	ND

ND = Not Detected      \* in units of mg/l

**Table 2: Some Priority Pollutants Detected in Gas Station Oil Grit Separator Sediments or Pool Water (Schueler and Shepp, 1992)**

Napthalene	Di-n-octyl pthalate
2-Methylnapthalene	Benzo(b) flouranthene
Acenapthene	Indeno (123-cd) pyrene
Flourene	Di-n-butyl pthalate
Phenathrene	Toulene
Flouranthrene	Ethyl benzene
Pyrene	Total xylenes
Butylbenzylphthalate	Methylene chloride
Chrysene	Benzene
	Acetone phenols

Alabama, including vehicle service areas, parking lots, salvage yards, landscaped areas, and loading docks. They employed the rapid Microtox procedure to assess the possible toxicity of several hundred runoff samples.

Although their monitoring data was variable, they reported that many of the maximum PAH and metals concentrations in runoff samples were found at vehicle service areas and parking lots, as opposed to street surfaces. Of greater concern, nearly 60% of the hotspot runoff samples were classified as moderately to most toxic, according to their relative toxicity screening procedure.

#### Are Hotspots Environmentally Significant?

The mere presence of high pollutant concentrations at hydrocarbon hotspots does not always imply actual toxicity. Indeed, acute toxicity to aquatic organisms exposed to hotspot runoff is probably a rare event. This is due to relatively brief exposures during storm events, large dilution factors in urban creeks, and the fact that many pollutants are strongly bound to sediments and thus are not readily available to aquatic life. Pitt and Field (1992) reviewed a series of studies that provide convincing evidence of longer-term chronic toxicity to aquatic organisms when exposed to urban runoff.

The greatest environmental risk appears to occur when metal and hydrocarbon-laden sediments are deposited in downstream lakes and estuaries. The bottom sediments of many small, highly urbanized estuaries are heavily contaminated with metals and PAHs. Runoff from urban hotspots appears to be a major contributing factor to sediment contamination in these cases, as witnessed in both the Anacostia and Delaware estuaries (Schueler and Shepp, 1992; McKenzie and Hunter, 1979). The consequences of sediment contamination often include greatly reduced benthic diversity and transfer of pollutants into fish tissue. Techniques to remedy bottom sediment contamination are in their infancy, and have yet to be proven effective.

#### Difficulty in Treating Hotspots

Few stormwater technologies are currently available to effectively control the runoff from hydrocarbon hotspots. Most hotspot source areas are less than an acre in size, exist in already developed areas, and are widely scattered across the urban landscape. Nichols (1993) notes that there are over 1,500 vehicle maintenance operations in the Washington, DC area alone.

The most common method to control hydrocarbon loadings from small sites has been the oil grit separator (OGS). It consists of a concrete structure linked to the storm drain system with two pools used to trap oil and grit (Figure 1). Recent research, however, indicates that oil grit separators are not effective in trapping pollutants (see article 119). For example, in field inspections of over 100 OGS systems, the average depth of trapped sediment was found to be a mere two inches.

Further, the mass of trapped sediments in OGS systems did not increase over a five year time frame. Monthly sampling revealed sharp reductions in the depth of trapped sediments of as much as 25 or 50% from one month to the next. Dye tests indicated that OGS systems had a residence time of less than 30 minutes during even minor storms. In contrast, Pitt *et al.* (1991) conclude that at least 24 hours of settling are needed to achieve any meaningful reduction in potential toxicity from hotspot areas.

The poor performance of oil grit separators can be attributed to three key flaws: (1) an on-line design that promotes frequent resuspension of previously deposited oil and sediments, (2) insufficient treatment volume, and (3) poor internal geometry.

#### Prospects for Improving On-Site Technology

Can the dismal performance of the current generation of oil grit separators be improved? New off-line designs have been developed in a number of communities to reduce resuspension (Shepp, 1992). Not much performance data are yet available to evaluate the performance of these new designs. However, it is reasonable to expect that they will be more retentive than current designs, but the question remains—by how much?

Ultimately, the effectiveness of any design is dependent on regular and frequent clean-out of trapped sediments. This, unfortunately, has been the “Achilles heel” of existing OGS technology. For example, in a recent Maryland study not a single OGS system out of over 100 inspected had ever been maintained.

Four factors explain this poor track record. First, a market does not yet exist to clean out and dispose of sediments. Few vendors are available to perform the task themselves. Second, many local governments have been slow in enforcing clean-out requirements on small business owners. Third, clean-outs are quite expensive, ranging from as much as \$1,000 to \$2,000

per site each year. Lastly, concerns about the actual or perceived toxicity of the trapped sediments have limited options for safe and economical disposal. Many landfill operators are loath to accept wet sediments with pollutant concentrations on the order of those reported in Table 1.

Sand filters may turn out to be a better alternative for treating runoff from hydrocarbon hotspots than OGS systems. As a filtering medium, sand is very effective in "straining" out hydrocarbons and metals. Also, most sand filters are designed to treat a much greater volume of runoff than OGS systems. Perhaps most importantly, clean-out of sand filters is easier and less frequent. On the downside, sand filters are more expensive to construct, and may still be subject to disposal problems at some hotspot sites.

Source control may hold the greatest promise to reduce the delivery of pollutants from hotspots. This pollution prevention approach stresses the importance of eliminating the spills, leaks, and emissions that create the hotspot in the first place. A series of better handling, recycling, storage and disposal practices can reduce the chance that automotive fluids and cleaning solvents come into contact with rainwater and run off the site. The Santa Clara Valley Nonpoint Source Control Program has published an excellent summary of pollution prevention practices for gas stations (see article 136).

- TRS

### Summary

Although small in size, pollution hotspots are prevalent in the urban landscape. More monitoring is needed to define the magnitude of the metal and PAH loads they deliver to downstream waters. Currently, few effective techniques are available to treat hydrocarbon hotspots. Further testing of new designs of oil grit separators and sand filters is warranted.

In the end, our capability to reduce hotspots may well depend on solving institutional problems—assuring regular and environmentally safe sediment clean-outs, and preventing pollutants from being exposed to stormwater runoff at hotspot areas. See also articles 119 and 120.

### References

- Hoffman, *et al.* 1982. "Petroleum Hydrocarbons in Urban Runoff From a Commercial Land Use Area." *JWPCF*, 54(11): 1519-1528.
- Mackenzie and Hunter. 1979. "Sources and Fates of Aromatic Compounds in Urban Stormwater Runoff." *ES&T*, 13(2): 179-183.
- Nichols, G. 1992. *Waste Management Practices of Vehicle Maintenance Businesses and Local Government Vehicle Fleet Operations*. Metro Washington COG. U.S. EPA Office of Pollution Prevention. 52 pp.
- Pitt and Field. 1990. *Hazardous and Toxic Wastes Associated With Urban Stormwater Runoff*. 16th Annual Hazardous Waste Research Symposium. U.S. EPA-ORD. Cincinnati, OH.
- Pitt *et al.* 1991. *The Treatability of Urban Stormwater Toxicants*. Intl. Conf. on Integrated Stormwater Management. Natl Univ. of Singapore.
- Santa Clara Valley Nonpoint Source Control Program. 1993. *Best Management Practices for Automotive-Related Industries*. 28 pp.
- Schueler, T. 1987. *Controlling Urban Runoff: A Practical Manual for Planning and Designing Urban BMPs*. Metro Washington COG. 275 pp.
- Schueler, T. and D. Shepp. 1993. *The Quality of Trapped Sediments and Pool Water Within Oil Grit Separators in Suburban MD*. Metro Washington COG. 48 pp.
- Shepp, D. 1992. *Improved Design for the Oil/Grit Separator System*. Metro Washington COG. District Environmental Regulatory Administration. 14 pp.

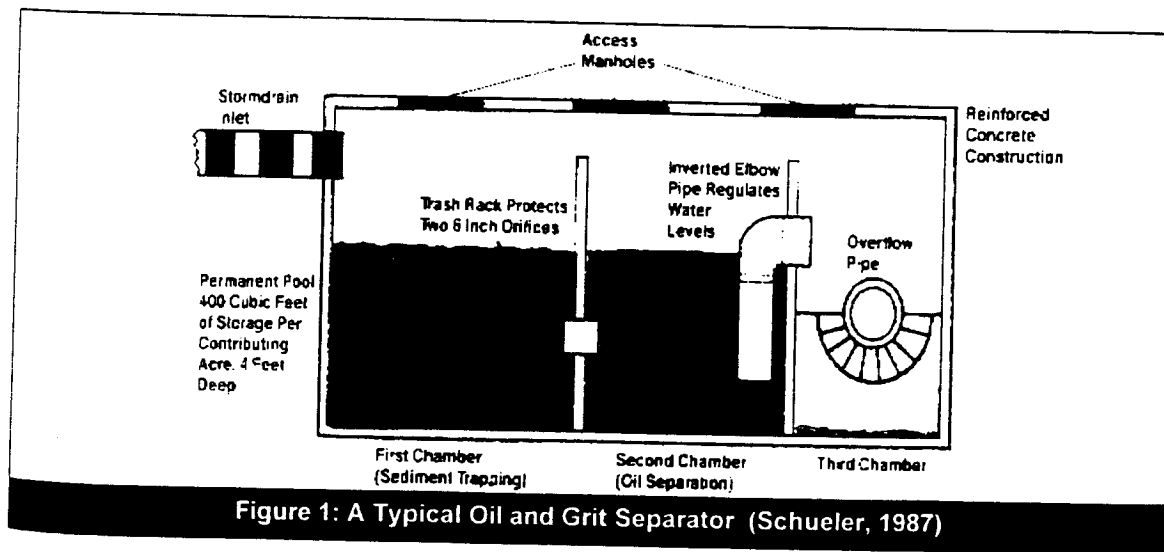

# Influence of Snowmelt Dynamics on Stormwater Runoff Quality

by Gary L. Oberts, Metropolitan Council, St. Paul, MN

**P**otential water pollution associated with melting snow are a concern to watershed managers in northern climates. In fact, in some urban areas, substantial portions of the annual load of pollutants such as hydrocarbons, metals, solids, nutrients, and chlorides come from snowmelt and early spring runoff events. Thus, the annual cycle of pollutant build-up and subsequent release during snowmelt can be a real threat to the attainment of water quality objectives.

This article examines the mechanisms involved in snow pollutant accumulation and the movement of various pollutants from the snowpack. With this knowledge, practitioners can plan management actions to anticipate changing flows and pollutant concentrations. Techniques that can be incorporated include the designation of "salt-free" areas near key streams and wetlands, and dumping plowed snow in pervious areas where melt water can infiltrate.

### The Snowmelt Sequence

Snowmelt can be described as a predictable process with three distinct stages (Figure 1). The first melt stage

is called *pavement melt*. As the name implies, it occurs when deicers are applied or the sun shines on heat-absorbing paved areas. These applications result in a winter-long sequence of chemically-driven melt events in which very saline water carries accumulated road pollutants into drainage systems and local receiving waters.

The second melt stage involves the more gradual melt of snow piles adjacent to road surfaces. *Roadside melt* contributes runoff intermittently as chemical splash and solar radiation gradually reduce piled snow. The final stage of the snowmelt sequence is the melt of non-paved pervious areas of the site, such as grassed lawns. The *pervious area melt* stage has the potential to contribute a substantial volume of runoff quickly, particularly when accelerated by a rain event.

### Runoff Quantity

The volume of runoff generated by each of the three melt stages is dictated primarily by the amount of snow and the weather conditions (Table 1). In most cases, runoff produced during pavement melt is not substantial. The end-of-season melt of the snowpack (i.e.,

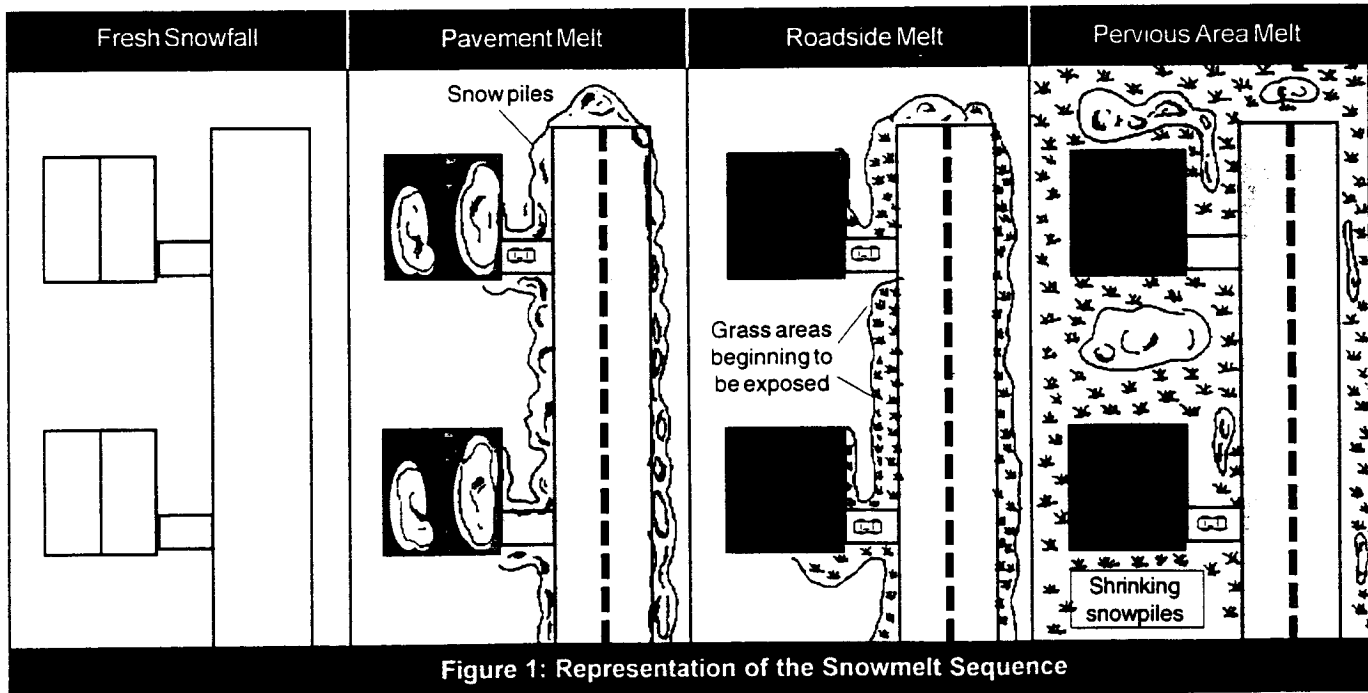

Figure 1: Representation of the Snowmelt Sequence

roadside and pervious area melt), however, often constitutes the largest single annual runoff event in northern climates. Often this melt lasts several weeks and can be magnified with concurrent rainfall (Bannerman *et al.*, 1983; Glancy, 1988; Westerstrom, 1984).

Figure 2 is an example of the significance of the large runoff produced by an end-of-season snowmelt event in an urban catchment in Minnesota (Oberts *et al.*, 1989). The importance of the melt event was magnified by several rain-on-snow events that occurred from mid-March to early-April, 1989. The snowmelt runoff is dramatic relative to the annual water budget, particularly when compared to runoff from the larger rain events (e.g., a 3.41 inch storm — 10-year frequency — that occurred in May, 1988).

### Runoff Quality

#### Pollutant Sources

Pollutants accumulate in snow due to several processes. First, falling snowflakes are effective scavengers of both particulate and aerosol pollutants (Colbeck, 1978). After snow has fallen, the snowpack is subject to both episodic and continuous deposition of airborne pollutants from local urban emissions, as well as long distance transport of pollutants from activities unrelated to the locale (Couillard, 1982; Landsberger and Jervis, 1985; Schondorf and Herrmann, 1987; Vuorinen, 1986; Zajac and Grodzinska, 1981). Atmospheric deposition of toxic chemicals, nutrients, and solids have been noted on urban surfaces throughout the winter from sources such as fossil fuel combustion, refuse incineration, chemical processing, metal plating, and manufacturing (Boom and Marsalek, 1988; Horkeby and Malmqvist, 1977; Malmqvist, 1978; Novoyny and

Chesters, 1981; Schrimppff and Herrmann, 1979).

Pollutants are also directly deposited on the snowpack and other cleared surfaces in winter. Most of the street surface studies, however, have not focused on the build-up of pollutants under snowy conditions. This omission is critical because street loads of sediment and toxic materials are at an annual peak at the onset of winter melt and early spring rainfalls (Bannerman *et al.*, 1983). Vehicular deposition of petroleum products/additives and metals, the direct application of salt and anti-skid grits, and roadway deterioration are major contributors to the pollution of road surface snow (Malmqvist, 1978; Oberts, 1986; Soderlund *et al.*, 1970).

#### "First Melt" Effect

Roadway snow is quickly removed by rapid melt through salt application, removal to a dump site, or plowing over the roadway curb/edge. The first action results in immediate runoff, usually involving small volumes of water and a minor portion of the annual pollution load, although concentrations may be high (Novotny and Chesters, 1981). For example, in 1980 small mid-winter melts in Minnesota accounted for less than 5% of the annual total phosphorous and total lead loads, respectively. In contrast the end-of-winter melt accounted for about eight to 20% of the annual phosphorus and lead loads (Oberts, 1982).

Runoff pollution from snow removed to a dump site is a topic that has been well studied, particularly in Canada. High levels of chloride, lead, iron, phosphorus, biochemical oxygen demand, and total suspended solids have been reported in snow dump runoff (La Barre *et al.*, 1973; Oliver *et al.*, 1974; Pierstorff and Bishop, 1980; Scott and Wylie, 1980; Van Loon, 1972).

**Table 1: Runoff and Pollutant Characteristics of Snowmelt Stages**

Snowmelt Stage	Duration/Frequency	Runoff Volume	Pollutant Characteristics
Stage 1. Pavement Melt	Short, but many times in winter	Low	Acidic, high concentrations of soluble pollutants, Cl <sup>-</sup> , nitrate, lead. Total load is minimal.
Stage 2. Roadside Melt	Moderate	Moderate	Moderate concentrations of both soluble and particulate pollutants
Stage 3a. Pervious Area Melt	Gradual, often most at end of season	High	Dilute concentrations of soluble pollutants, moderate to high concentrations of particulate pollutants, depending on flow.
Stage 3a. Rain-on-snow Melt	Short	Extreme	High concentration of particulate pollutants, moderate to high concentrations of soluble pollutants. High total load.

R0079474

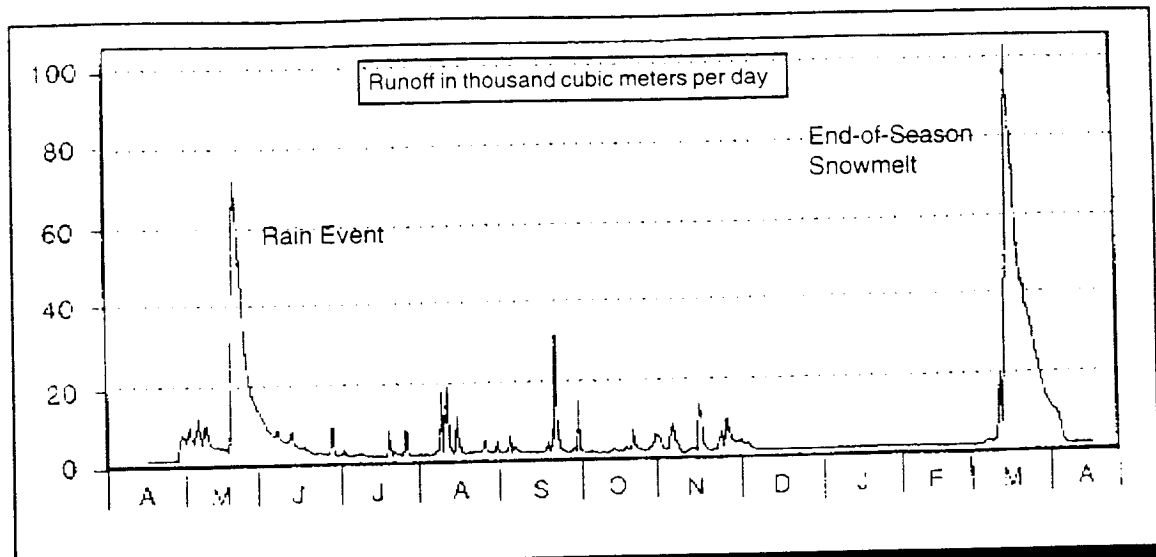

Figure 2: Runoff Hydrograph of an Urban Basin in St. Paul, MN

#### Roadside Snowpack

Plowing snow over to the roadside edge allows for the accumulation of debris, chemicals, grit, and litter over an entire winter. This material is easily mobilized in either short, chemically-driven melts or larger end-of-season runoff events. Material may also remain available for early spring rainfall washoff. Levels of contamination in a roadside snowpack can reach or even exceed that of a snowpack at a dump site (Oliver *et al.*, 1974; Pierstorff and Bishop, 1980; Scott and Wylie, 1980; Van Loon, 1972).

Once pollutants collect in a snowpack, a process of pollutant speciation associated with the freeze/thaw cycle begins to develop. This process has been called several different terms, including "freeze exclusion," "preferential elution," and "acid flushing." All these terms refer to basically the same phenomenon, wherein soluble pollutants are flushed from throughout the snowpack and concentrate at the bottom of the pack.

Several authors describe a process that begins when snowflakes respond to freezing and thawing cycles by metamorphosing (when ice crystals enlarge and round) (Colbeck, 1981; Hibberd, 1984; Schondorf and Herrmann, 1987). The reforming crystalline lattice does not allow impurities to be incorporated, so the impurities migrate to the outside of the crystal. They are loosely bound in this position and thus exposed for washoff by passing meltwater.

The heterogeneous nature of the snowpack allows for channelized meltwater to scavenge soluble pollutants randomly until the pack is saturated, whereupon pollutant mobilization becomes more uniform throughout the pack. In this condition, soluble pollutants are collected in a "wetted front" that moves through the pack, eventually reaching the bottom. At this position, they intersect the soil or other surface and move from

the pack as a highly concentrated, usually acidic, pulse of meltwater. This "first flush" of concentrated snowpack meltwater will either infiltrate into the soil or runoff, depending upon the conditions of the surface soils underlying the snowpack.

The degree to which soluble pollutants are washed from the snowpack depends upon the number of freeze/thaw cycles during the winter and whether the pack receives any outside moisture. Repeated freezing and thawing "purify" the hexagonal crystals and any added moisture mobilizes the released pollutants more quickly. Johannessen and Henriksen (1978) found in both laboratory and field studies that about 40 to 80% of 16 pollutants were released from experimental snowpacks with the first 30% of the liquid melt. This process seemed to be independent of the initial snowpack concentration of the pollutants. Their studies also showed that pollutant concentrations in the initial melt were two to 2.5 times greater than those in the remaining snowpack (reaching as high as 6.5 times the snowpack levels in the very first fractions of melt).

Zapf-Gilje *et al.* (1986) found in their study of frozen secondary effluent that the first 20% of a melt contained 65% of the phosphorus and 90% of the total nitrogen. The removal was not related to initial pollutant content in the frozen effluent. In contrast, Schondorf and Herrmann (1987) reported that 90% of the particulate-associated polycyclic aromatic hydrocarbons (PAHs) in a snow column were contributed in the last 10% of the melt.

Particulate matter is filtered or coagulated with other particles as it moves through the snowpack and remains behind while the soluble component washes through. Pollutants such as tightly bound organics and metals adsorb to sediment and organic compounds. Schondorf and Herrmann (1987) also found that rain-on-snow

washes fine-grained particulate through the pack and flushes out metals and adsorbed organic pollutants.

#### *Infiltration*

Infiltration can occur at the bottom of a snowpack even into frozen or partially frozen soils. In fact, the very first portions of a melt generally infiltrate until the soil becomes saturated, leading to a progressive reduction in infiltration capacity (Bengtsson, 1984). Novotny (1988) explains that infiltration of substantial volumes of meltwater can occur into clay and loam soils, as well as sands, if impermeable frozen layers do not form before snow cover. The formation of these "concrete frosts" is a function of the amount of pore-water of the soil (Bengtsson, 1984).

Less soil moisture at freeze-up allows more meltwater to move through the available pore spaces. Once soils are saturated, however, the amount of runoff from the soil surface becomes a function of the degree of melt and the amount of downward movement of water through saturated soils. This situation can make the entire catchment 100% "functionally impervious" with the catchment actually contributing meltwater runoff. Bengtsson (1984) and Colbeck (1978) demonstrated that infiltration can vary from zero to 100%, depending upon the nature of the soil, the water content of the soil at freeze-up, and the degree of saturation reached during a melt event.

#### *Runoff*

The net effect of freeze exclusion is that meltwater moving from a snowpack has a different chemical quality depending upon the stage of the melt. Early in the melt, the primary movement out of the pack will be from soluble pollutants, followed by the particulate fraction. This applies only to water as it moves from the snowpack. It should be noted that the large volume of meltwater leaving the pack, particularly at peak melt, can wash off accumulated pollutants from paved surfaces as well as pick up additional pollutants from saturated soil surfaces.

Because the initial stages of melt are generally slow, the first melt stage runoff exerts a concentration "shock" of highly soluble pollutants, but not a high pollution load. More runoff is produced in the latter stages of the melt, which can generate high concentrations and high loads because particulates are washed out of the pack.

#### *Rain-on-snow*

Extreme pollutant loads can be experienced during the end-of-the-season melt if rain falls on a deep, saturated snowpack that has undergone repeated freeze-thaw cycles (Couillard, 1982; Schondorf and Herrmann, 1987). This event leads to a sudden release of soluble pollutants from the wetted front at the same time that soluble and particulate pollutants are flushed from the snowpack by the rainfall.

The large volume of melt runoff associated with rain-on-snow events also flushes pollutants that have accumulated on paved and soil surfaces. The intensity

**Table 2: Flow-Weighted Mean Snowmelt Concentrations in St. Paul Area by Site Type Compared With National NURP Study Averages. Data Reported in mg/l. (N)=No. of events.**

	Total susp. solids	Volatile susp. solids	Chemical oxygen demand	Total phos.	Dissolved phos.	Total Kjeldahl nitrogen	Nitrate	Chloride	Total lead
Storm Sewers N=(20-40)	148	46	169	0.70	0.25	3.52	1.04	230	0.16
Open Channels N=(1-5)	88	15	82	0.56	0.18	2.36	0.89	49	0.2
Creeks N=(2)	64	---	84	0.54	---	3.99	0.65	116	0.08
MEDIAN	112	38	112	0.70	0.18	3.39	0.91	116	0.10
NURP*	---	---	91	0.46	0.16	2.35	0.96	---	0.18

\*Runoff concentrations were obtained from over 2,300 rainfall events monitored at 22 project sites across the nation

R0079476

1

of a rain-on-snow event is usually greater than a summer thunderstorm because the soil is saturated or frozen and the rapidly melting snowpack provides added runoff volume.

#### *Levels of Pollution*

Monitoring of pollutant concentrations in snowmelt runoff is much more scarce than monitoring of stormwater runoff. Research in the Minneapolis-St. Paul region of Minnesota over the last decade has shed more light on pollutant concentrations in snowmelt. Runoff data from 49 short-term January and February snowmelts and end-of-season March and April snowmelt events are provided in Table 2 (Oberts, 1982; Oberts and Osgood, 1988; Oberts *et al.*, 1989). For comparison, the table also lists national runoff concentrations obtained from NURP sites (USEPA, 1983). Snowmelt runoff contains elevated levels of solids, nutrient, and chemical oxygen demand (COD), in addition to the high levels of lead and chloride. Both total and volatile suspended solids concentrations in snowmelt runoff are considerably lower than the flow-weighted mean concentrations from rainfall events collected at the same sites. Concentrations of COD, organic nitrogen (TKN), and lead are higher in the melt events for most sites, and chloride and nitrate are much higher in the melt at all sites. Total and dissolved phosphorous are generally similar for both snowmelt and rainfall runoff.

A review of monitoring data from other locations shows that the Minnesota values are within the range of snowmelt runoff quality observed elsewhere. Snowmelt runoff measured in Ottawa revealed that even though high concentrations of lead and chloride accumulate in snow dumps and along roadsides, the actual levels in runoff are much lower (La Barre *et al.*, 1973; Oliver *et al.*, 1974). This is thought to be due to infiltration and adsorption of pollutants to soils during melt. For example, lead concentrations in Ottawa roadside and snow dumps reached levels as high as 113 mg/l, but concentrations from this snow after it had melted declined to <0.01 to 1.19 mg/l.

Sediment samples taken from a river near the dump sites showed lead levels as high as 1,344 mg/kg, but dropped to 183 mg/kg the year after dumping stopped near the site. Chlorides from this same study in Ottawa reached as high as 15,266 mg/l in a snowpack adjacent to a street in a commercial area and 2,500 mg/l at the dumps, but runoff levels from a storm sewer in the city declined to 219 mg/l (again close to the Table 2 values for runoff) and the dump averaged 500 mg/l.

Soderlund *et al.* (1970) reported snowmelt runoff in Stockholm reached levels as high as 450 mg/l chloride, 12 mg/l oil, and 1.0 mg/l total phosphorus. The authors found that rapidly rising temperatures generated a substantial volume of meltwater, which then washed a

tremendous amount of accumulated winter debris from street surfaces. Again, monitoring the rain events during or shortly after the melt of the snowpack yielded very high concentrations of many pollutants.

Pierstorff and Bishop (1980) reported that dump site melt runoff from Durham, New Hampshire and elsewhere reached as high as 664 mg/l Cl, 50 mg/l COD, and 13 mg/l oil and grease. Boom and Marsalek (1988) found that PAH levels in Sault Ste. Marie, Ontario, meltwater runoff (3 to 12 µg/l) differed little from the levels seen in the snowpack. Couillard (1982) noted that melt events exhibited very toxic levels of metals and that rain occurring during a melt tended to dilute the concentration, and hence the toxicity, of meltwater.

Alley and Ellis (1978) recorded mean meltwater lead levels of 0.7 mg/l, and similarly high concentrations of several other trace metals in Denver, Colorado. Bannerman *et al.* (1983) reported the highest annual concentrations of TSS, Cl, lead, and total zinc were recorded in meltwater and early spring rainfall events in most of their Milwaukee, Wisconsin monitoring sites. They also noted that significant loads of sediment and trace metals are produced during this short interval, with 20 to 33% of the annual load being contributed.

This finding is consistent with Minnesota meltwater where a substantial amount (about 65%) of the annual sediment, organic, nutrient, and lead load, and virtually all of the chloride load from urban areas are produced by snowmelt and early spring rainfall events (Oberts, 1982). Total loads of pollution are often of more concern than concentration, depending upon whether the receiving water is most sensitive to the strength of a pollutant or to total accumulation. For example, lakes respond to nutrient loads, whereas aquatic life in a stream are more likely to be concentration sensitive and react to the peak concentrations of the toxic materials.

#### **Conclusions**

Snowmelt runoff comes from short duration, chemically driven events and from longer duration, end-of-season events. Meltwater runoff carries pollutants that have accumulated all winter in the snowpack, as well as street and soil surface material that washes off of these surfaces. Atmospheric fallout, industrial activity, vehicular emissions/corrosion/fluid leaks, roadway deterioration, urban litter, and anti-skid grit and chemical deicers are sources of the solids, nutrients, and toxic materials that accumulate in a snowpack. Soluble pollutants are preferentially leached or purged from the snowpack in the early stages of the melt. Later melt stages carry the particulate fraction along with a large volume of meltwater, which also washes pollutants from the urban surface.

**R0079477**



**Table 3: Watershed Protection Techniques for Snow and Snowmelt Conditions**

- Use of De-icing Compounds
  - Use alternative de-icing compounds such as CaCl<sub>2</sub> and calcium magnesium acetate (CMA)
  - Designate "salt-free" areas on roads adjacent to key streams, wetlands, and resource areas
  - Reduce use of de-icing compounds through better driver training, equipment calibration, and careful application
  - Sweep accumulated salt and grit from roads as soon as practical after surface clears
- Storage of De-icing Compounds
  - Store compounds on sheltered, impervious pads
  - Locate at least 100 feet away from streams and flood plains
  - Direct internal flow to collection system and route external flows around shelters
- Dump Snow in Pervious Areas Where It Can Infiltrate
  - Stockpile snow in flat areas at least 100 feet from stream or floodplain
  - Plant stockpile areas with salt-tolerant ground cover species
  - Remove sediments and debris from dump areas each spring
  - Choose areas with some soil-filtering capacity
- Blow Snow from Curbside to Pervious Areas
- Operate Stormwater Ponds on a Seasonal Mode
- Use Level Spreaders and Berms to Spread Meltwater Over Vegetated Areas
- Intensive Street Cleaning in Early Spring can Help Remove Particulates on Road Surfaces

An understanding of snowpack and snowmelt dynamics is useful to develop effective techniques for treating snowmelt runoff. Different techniques should be employed at each stage of the meltwater sequence, so as to effectively address the constantly changing flows and pollutant concentrations that occur as the melt progresses. A list of some effective techniques is provided in Table 3. See also articles 71, 75 and 139.

**References**

Alley, W.M. and S.R. Ellis. 1978. "Trace Elements in Runoff From Rainfall and Snowmelt at Several Localities in the Denver, Colorado, Metropolitan Area." *In Proceedings of the International Symposium on Urban Storm Water Management*, 24-27 July 1978. Univ. of Kentucky, Lexington. 193-198 pp.

Bannerman, R., K. Baun, M. Bohn, P.E. Hughes, and D.A. Graczyk. 1983. "Evaluation of Urban Nonpoint Source Pollution Management in Milwaukee County, Wisconsin." *Volume 1: Urban Stormwater Characteristics, Sources, and Pollutant Management by Street Sweeping*. Wisc. Dept. of Natural Resources, Madison, 206 pp.

Bengtsson, L. 1984. "Modeling Snowmelt Induced Runoff With Short Time Resolution." *In P. Balmér, P-A. Malmqvist, and A Sjöberg (eds.), Proceedings of the Third International Conference on Urban Storm-Drainage: Vol. 1, Analysis and Design of Stormwater Systems 4-8 June 1984. Göteborg, Sweden.* 305-314 pp.

Boom, A. and J. Marsalek. 1988. "Accumulation of Polycyclic Aromatic Hydrocarbons (PAHs) in an Urban Snowpack." *The Science of the Total Environment* 74:148.

Buttle, J.M. and F. Xu. 1988. "Snowmelt Runoff in Suburban Environments." *Nordic Hydrology* 19:19-40.

Colbeck, S.C. 1978. "Physical Aspects of Water Flow Through Snow." *Advances in Hydrosience* 11:165-206.

Colbeck, S.C., 1981. "A Simulation of the Enrichment of Atmospheric Pollutants in Snow Cover Runoff." *Water Resources Research* 17(5): 1,383-1,388.

Couillard, D. 1982. "Toxicity Assessment of Snowmelt Water Runoff in an Urban Area" (*in French*). *Water Research* 16:1,197-1,205.

R0079478

- Dunne, T. and R.D. Black. 1971. "Runoff Processes During Snowmelt." *Water Resources Research* 7(5):1.160-1.171.
- Glancy, P.A. 1988. *Streamflow, Sediment Transport, and Nutrient Transport at Incline Village, Lake Tahoe, Nevada, 1970-73*, U.S. Geological Survey Water Supply Paper 2,313. 53 pp.
- Hibberd, S. 1984. "A Model for Pollutant Concentrations During Snowmelt." *Journal of Glaciology* 30(104):58-65.
- Horkeby, B. and P.A. Malmqvist. 1977. *Microsubstances in Urban Snow Water*. IAHS-AISH Publication 123:252-264.
- Johannessen, M. and A. Henriksen. 1978. "Chemistry of Snow Meltwater: Changes in Concentration During Melting." *Water Resources Research* 14(4):615-619.
- La Barre, N., J.B. Milne and B.G. Oliver. 1973. "Lead Contamination of Snow." *Water Research* 7:1.215-1.218.
- Landsberger, S. and R.E. Jervis. 1985. "Sulphur and Heavy Metal Pollution in Urban Snow: Multi-elemental Analytical Techniques and Interpretations." *Annals of Glaciology* 7:175-180.
- Malmqvist, P.-A. 1978. "Atmospheric Fallout and Street Cleaning - Effects on Urban Storm water and Snow." *Progress in Water Technology* 10(5/6):495-505.
- Novotny, V. 1988. "Modeling Urban Runoff Pollution During Winter and Off-Winter Periods." *Advances in Environmental Modelling* 1988:43-58.
- Novotny, V. and G. Chesters. 1981. *Handbook of Nonpoint Pollution: Sources and Management*. Van Nostrand Reinhold Company, NY. 555 pp.
- Oberts, G.L. 1982. *Water Resources Management: Nonpoint Source Pollution Technical Report*. Metropolitan Council, St. Paul, MN. Publ. No. 10-82-016.253 pp.
- Oberts, G.L. 1986. "Pollutants Associated With Sand and Salt Applied to Roads in Minnesota." *Water Resources Bulletin* 22(3):479-483.
- Oberts, G.L. and R. Osgood. 1988. *Lake McCarrons Wetland Treatment System: Final Report on the Function of the Wetland Treatment System and the Impacts on Lake McCarrons*. Metropolitan Council, St. Paul, MN. Publ.No. 590-88-095. 227 pp.
- Oberts, G.L., P.J. Wotzka and J.A. Hartsoe. 1989. *The Water Quality Performance of Select Urban Run-off Treatment Systems*. Metropolitan Council, St. Paul, MN, Publ. No. 590-89-062a. 170 pp.
- Oliver, B.G., J.B. Milne and N. LaBarre. 1974. "Chloride and Lead in Urban Snow." *J. Water Pollution Control Federation* 46(4):766-771.
- Pierstorff, B.W. and P.L. Bishop. 1980. "Water Pollution From Snow Removal Operations." *J. of the Environmental Engineering Division, Proceedings of the American Society of Civil Engineers*. 106(EE2):377-388.
- Schöndorf, T. and R. Herrmann. 1987. "Transport and Chemodynamics of Organic Micropollutants and Ions During Snowmelt." *Nordic Hydrology* 18:254-278.
- Schrimppf, E., W. Thomas and R. Herrmann. 1979. "Regional Patterns of Contaminants (PAH, pesticides and trace metals) in Snow of Northeast Bavaria and Their Relationship to Human Influence and Orographic Effects." *Water, Air, and Soil Pollution* 11:481-497.
- Scott, W.S. and N.P. Wylie. 1980. "The Environmental Effects of Snow Dumping: A Literature Review." *J. of Environmental Management* 10:219-240.
- Söderlund, G., H. Lehtinen and S. Friberg. 1970. "Physicochemical and Microbiological Properties of Urban Stormwater Run-off." *Advances in Water Pollution Research* 1(2):1-8.
- USEPA. 1983. *Results of the Nationwide Urban Runoff Program: Volume 1 - Final Report*. U.S. Environmental Protection Agency, Washington, D.C. 200 pp.
- Van Loon, J.C. 1972. "The Snow Removal Controversy." *Water Pollution Control* 110:16-20.
- Vuorinen, A. 1986. "Emission of Lead by Highway Traffic: Lead Fixation and Speciation." *Univ. of Helsinki Report* 4:159-162.
- Westerström, G. 1984. "Snowmelt Runoff from Porsön Residential Area, Luleå, Sweden." In: F. Balmér, P.-A. Malmqvist, and A. Sjöberg (eds.), *Proceedings of the Third International Conference on Urban Storm Drainage: Volume 1, Analysis and Design of Stormwater Systems*, 4-8 June 1984. 315-323 pp. Göteborg, Sweden.
- Zajac, P.K. and K. Grodzinska. 1981. "Snow Contamination by Heavy Metals and Sulphur in Cracow Agglomeration (Southern Poland)." *Water, Air and Soil Pollution* 17:269-280.
- Zapf-Gilje, R., S.O. Russell and D.S. Mavinic. 1986. "Concentration of Impurities During Melting Snow Made From Secondary Sewage Effluent." *Water Science and Technology* 18:151-156.

R0079479

# Nutrient Movement from the Lawn to the Stream?

Are lawns a significant source of nutrients to urban streams? The answer to this frequently asked question appears to be "maybe." On the one hand, over-fertilization of home lawns has been frequently cited as an important and controllable nutrient source within urban watersheds, and has been a key element of many local outreach and pollution prevention campaigns. On the other, turfgrass researchers report that well-tended lawns produce minimal runoff and nutrient export. In this article, we explore the question of whether nutrients are moving from the lawn to the stream, by examining three areas:

- Trends in urban fertilizer use
- Research on the nutrient cycle in urban lawns
- Actual nutrient levels recorded in urban streams

The article begins with an analysis of recent trends in lawn fertilization *recommendations*, and then summarizes what we know about *actual* fertilizer applications and behavior by the homeowner and lawn care companies.

Next, the nutrient cycle of the lawn is described, including major *inputs*, *storage components*, and *outputs* of nitrogen and phosphorus. Potential nutrient *inputs* include fertilizer applications, atmospheric deposition, runoff from impervious areas such as rooftops, irrigation water with elevated nutrient content, fixation, and decomposition of clippings left on the lawn. *Storage components* include soil, thatch, and standing turf. Potential *outputs* include volatilization, denitrification, runoff, leaching, and clippings not left on the lawn.

Lastly, the article reviews monitoring data from nearly 40 residential watersheds across the country to detect whether nutrient levels in urban streams are elevated during storm events, in relation to other land uses or nutrient sources.

## Trends in Urban Lawn Fertilization

### *Historical Fertilizer Use*

Fertilizer use mushroomed after World War II along with the chemical industry. Fertilization rates recommended by turf researchers and garden writers also grew sharply during this period. A typical recommendation prior to 1940 was 44 pounds of nitrogen\* fertilizer per acre per year (Jenkins, 1994).

By the 1965 edition of the popular *America's Garden Book*, recommended fertilization rates had climbed to 283 pounds nitrogen per acre annually. Some fertilizer recommendations during the 1970s were as high as 348 pounds per acre per year (Jenkins, 1994). By 1984, EPA estimated nearly a million tons of chemical fertilizers were applied yearly across the nation's lawns—more than India applied to all its food crops in the same year (Bormann, 1993).

In recent years, the trend toward ever greater fertilization has begun to change. Part of this is due to the recognition that excess nutrients can degrade the water quality of streams, lakes, and estuaries. Also, hardier grasses such as fine fescues and native buffalograss have become more popular in response to growing water shortages. These tough grasses have lower nitrogen requirements than other grasses (Schultz, 1989). Lastly, turf research documented that lawn clippings can provide significant nutrient value and help promote dense and vigorous grass. In response to these trends, some extension agents are now recommending lower nitrogen fertilization rates. For example, according to the Northern Virginia Soil and Water Conservation District, a good rule of thumb is to use half of the manufacturer's recommended application—generally less than 44 lbs/acre in any single application. Other current extension and garden literature recommendations range from 87 to 174 lbs/acre/year of nitrogen.

\* Lawn feeding recommendations are often expressed in terms of nitrogen since this nutrient keeps grass green and soft by promoting rapid leaf growth. The vast majority of retail lawn fertilizers are "complete" fertilizers, meaning they contain nitrogen, phosphorus, and potassium. Nitrogen stimulates leaf growth; phosphorus enhances stem and root strength (as well as promoting flowering); and potassium encourages seed-ripening and stress-tolerance. Phosphorus and potassium also impart insect and disease resistance. The percentages vary, from nitrogen-heavy formulas such as 29-3-4 to more even-handed formulations such as 10-6-4, or 10% nitrogen, 6% phosphorus, and 4% potassium by weight.

**Table 1: Summary of Lawn Care Surveys**

Lawn care study	Wisconsin	Virginia	Maryland	Maryland	Minnesota
Reference	Kroupa & Associates, 1995	Aveni, 1994	Kroll and Murphy, 1994	Smith <i>et al.</i> , 1993	Dindorf, 1992
Homes surveyed	204	100	484	403	136
Proportion of homes that use fertilizers	54% (69% homeowner applied)	79% (85% homeowner applied) less than 20% had soil tested	38%	87%	85% (18% had soil tested)
Number of applications per year	2.4	no data reported	1 (37%); 2 (31%); 3-4 (16%)	no data reported	no data reported

*Homeowner Fertilization Behavior*

Surveys suggest that roughly 70% of all lawns are regularly fertilized, regardless of whether additional nutrients are needed (Table 1). For example, in Minnesota, 85% of respondents reported using fertilizers, but only 18% had their soil tested to confirm the need (Dindorf, 1992). Likewise, 79% of Virginia homeowners used fertilizers, but less than 20% had their soil tested (Aveni, 1994).

Few homeowners bother to contact the local extension office for recommended fertilization rates. Instead, most rely on the local hardware store or garden center. In fact, a survey in Virginia found that product labels were the number one information source for homeowners, while Cooperative Extension Service ranked last (Aveni, 1994). Label directions vary in terms of specificity. While all labels indicate how many square feet the bag should cover, each takes a different approaches on how often the product should be applied. Some specify two or three applications per year. Others give no frequency at all and say "may be applied at any season." Interestingly, the instructions for bagged fertilizer fail to mention soil tests.

Depending on the type of lawn care product, a homeowner might apply anywhere between 44 and 261 lbs. nitrogen/acre and from four to 26 lbs. phosphorus/acre each year. Still, this begs the question of whether or not homeowners follow package directions. There is very little actual data on homeowner application rates. A survey of homeowners in Long Island found an average application rate of 107 lb. nitrogen per acre per year (Morton, 1988.) In a Wisconsin survey, 66% of homeowners reported applying exactly the amount recommended, 31% reported using less, and only 3%

reported using more than the recommended amount (Kroupa and Associates, 1995.) While that is an encouraging statistic, it must be remembered that it is a self-reported one (i.e. without verification).

What about homeowners who rely on others for their lawn care? About two-thirds of all homeowners perform their own lawn care, with lawn care companies servicing the rest. Still, in some more affluent neighborhoods, as many as 50% of lawns may be managed by a service. From the mid 1960s to the mid 1980s, the lawn care service industry grew at a rate of 25 to 30% per year (Jenkins, 1994).

Lawn care companies usually offer a variety of service plans, but the most common is a basic service plan that consists of five to eight visits per year. Most visits are dual-purpose, in that fertilizer and pesticides are both applied. Unless a customer specifically requests a soil test or a special application rate, most lawn companies give every lawn serviced by the company the same rate of fertilization. Morton (1988) reported that many commercial lawn care services apply 194 to 258 lbs/ac/yr of nitrogen.

Homeowner surveys also indicate that spring fertilization is still common in cool-season grass regions. Some homeowners even reported fertilizing in winter. In any event, homeowners and lawn care companies may not always apply fertilizer at the optimal time. Still, no matter how much fertilizer is applied to the lawn, the key question is whether enough of it finds its way to urban streams to cause water quality problems.

**The Nutrient Cycle in the Urban Lawn**

The nutrient cycle in an intensively managed lawn is quite complex, and consists of many interacting

inputs, outputs and storage components. A better understanding of the urban lawn nutrient cycle can identify important nutrient pathways, and help estimate the potential for nutrient export. A schematic of the major elements of the nitrogen and phosphorus cycle is shown in Figure 1.

In the absence of fertilization, nitrogen is found in three major forms in the urban lawn (Figure 1a). The largest quantity of nitrogen is present in *organic* form, either in the soil, thatch or grass itself. The large reservoir of organic nitrogen, however, cannot be taken up by plant roots until it is converted into more soluble *inorganic* forms, such as nitrate and ammonium. The process is facilitated by microbes and bacteria within the soil that are continually breaking down organic nitrogen into ammonia, and ultimately, into nitrate. Most grass plants prefer to take up nitrate nitrogen, although some species (especially on acid soils) can take up ammonia-nitrogen as well. Since inorganic nitrogen is quite soluble, it moves with soil water and can leach out of the root zone. The last form is *atmospheric nitrogen gas* which is present in the pore spaces of the soil and can be converted into inorganic nitrogen by nitrogen-fixing bacteria found in leguminous plants (such as clover).

The phosphorus cycle on urban lawns is slightly less complex (Figure 1b). Phosphorus is primarily found in two forms: *phosphate* ( $PO_4$ ) and other forms of soluble phosphorus (that has weathered from rocks or been released during the decomposition of organic matter), and *organic* phosphorus (that is contained in organic matter in the soils, thatch and grass itself). Phosphate is present in small quantities, and is taken up directly by grass roots, while organic phosphorus is not available for plant uptake until decomposers break it down into soluble forms.

Much of our knowledge of each pathway in the urban nutrient cycle is derived from experimental plots rather than field monitoring. In addition, most studies have focused on a single component of the lawn nutrient cycle (e.g. applied fertilizer, leaching), rather than

attempting to model the full dynamics of the turfgrass cycle. Thus, we have a very dim understanding of how inputs shift nutrients from one component to another, or how rates of transport are controlled. The schematic does suggest that internal storage components such as soil, thatch and clippings are a major element of the cycle and will influence the pollution potential of a given fertilization or watering regime. This also suggests that estimates of the amount of fertilizer needed for turfgrass should credit supplemental nutrient sources such as atmospheric deposition, thatch, mulched clippings, and irrigation water.

#### *Input 1: Fertilizer Application*

As already discussed, there is some uncertainty about actual fertilization rates for home lawns. Still, it is clear that fertilization rates can approach significant levels. Table 2 offers a comparison of fertilization rates among several land uses. It shows that nitrogen amounts commonly applied by homeowners rival those applied to golf fairways and crops. Lawn care services appear to apply more nitrogen than is used on cropland or golf courses. Home lawns, however, receive less phosphorus inputs than crops.

#### *Input 2: Atmospheric Deposition*

The contribution of airborne nutrients to the lawn has long been ignored even though studies in the Washington metropolitan area estimate 17 lbs/ac of nitrogen and 0.7 lbs/ac of phosphorus (MWCOG, 1983). Sources of airborne nutrients include power plant and vehicle emissions. Atmospheric deposition to surfaces other than the lawn may also reach the lawn through *runon*.

#### *Input 3: Runon from Impervious Areas*

Impervious surfaces collect nutrients from atmospheric deposition, pet wastes, and blown in organic matter. These nutrients are easily washed off the surfaces in stormwater runoff. When runoff from impervi-

**Table 2: Comparative Chemical Application Rates in Pounds/acre/year in Maryland (Klein, 1990)**

Chemical	Cropland*	Golf fairway	Greens	Home lawn (do it yourself)	Home lawn (lawn service)
Nitrogen	184	150	213	44-261	194-258
Phosphorus	80	88	44	15	no data
Pesticides	5.8	37.3	45.1	7.5	no data

\* Corn/soybean rotation.

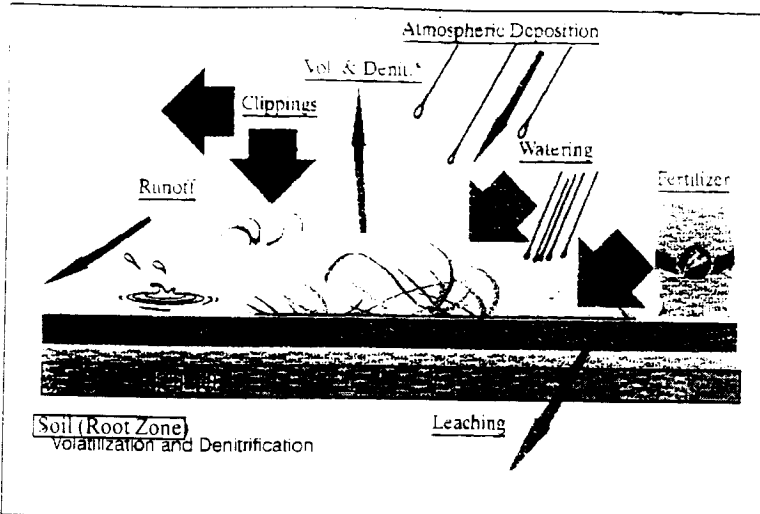

Figure 1a: Nitrogen Pathways to Urban Streams

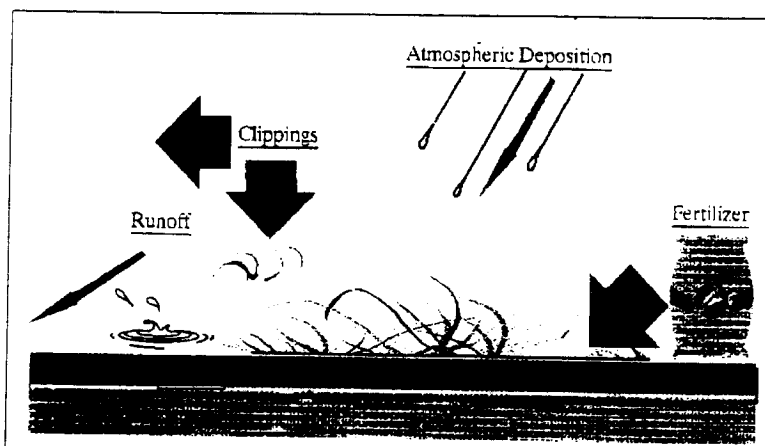

Figure 1b: Phosphorus Pathways to Urban Streams

ous areas flows onto lawns, this runoff becomes a nutrient source. Rooftops are probably the greatest source of runoff, and they can supply moderate concentrations of nitrogen and phosphorus. Bannerman (1994), for example, reported total phosphorus levels of 0.15 mg/l in residential roof runoff. Thomas and Greene (1993) reported nitrate levels of 0.1 to 0.3 mg/l in rooftop runoff.

*Input 4: Nutrient Content in Irrigation Water*

Many Midwestern municipalities are experiencing rising nitrate levels in public water supply wells. Exner and colleagues (1991) irrigated Nebraska turf plots with municipal water every third day regardless of rainfall from mid-May through late August. The amount of nitrogen delivered in the irrigation water was calculated to be 176 lbs/ac—more than the turfgrass required in a full year. While the irrigation level in Exner's study was designed to be excessive, the results do suggest that the

nutrient content in irrigation water can be a significant input to the lawn in some regions.

*Input 5: Nutrient Fixation by Plants*

Atmospheric nitrogen (N<sub>2</sub> gas) is not usable by plants until it is *fixed*, combined with oxygen or hydrogen into compounds which plants can assimilate. Bacteria living in the soil (*Clostridium*) and on the roots of certain plants (*Rhizobium*) are able to fix nitrogen. Clover, one of the rhizobium-bearing plants, can provide up to 30% of a lawn's yearly nitrogen requirement (Olkowski, 1991).

*Input 6: Decomposition of Clippings*

Petrovic (1990) reviewed nitrogen recovery from clippings. *Recovery* compares the amount of nitrogen present in clippings with the amount applied through fertilization. For example, if 10 lbs of nitrogen were applied to one acre of turf, and if the resultant clippings contained 10 lbs of nitrogen, nitrogen recovery would be 100%. Petrovic reports that recovery percentages vary with grass species, rate of fertilization, and the rate at which the nitrogen contained in the fertilizer becomes available. For example, at similar fertilization rates, 99% recovery was observed in perennial ryegrass compared to 60% recovery in creeping bentgrass. As fertilization rates increase above the optimum, the percent recovery declines. For fertilizers that release most of their nitrogen within one year, recovery percentages ranged from 25 to 60%. Recovery also varies with soil type, but there is less information available. One study found a 9% recovery difference in silt loam vs. clay loam (Petrovic, 1990).

Researchers at the University of Connecticut Agricultural Station used radioactive nitrogen to track what happened to applied nutrients when grass clippings were recycled. They found that nitrogen from the clippings was incorporated into new grass growth within a week. After three years, nearly 80% of the applied nitrogen had been returned to the lawn through the clippings (Schultz, 1989). The Rodale Institute Research Center reports that an acre of clippings provides an average of 235 pounds of nitrogen, 210 pounds of potassium, and 77 pounds of phosphorus (Meyer, 1995). Thus, if all clippings are returned to the lawn, they can meet much of the nutrient requirement.

*Storage Component 1: Soil Storage*

Soil is the largest reservoir of nutrients in the lawn, although most nutrients are found in organic form and are not readily available for plant growth. Soil tests in New Jersey found very high phosphorus levels in the soil of 80% of residential lawns (Liptak, 1992), but runoff studies have not examined the impact of long-term phosphorus buildup. In most regions, soils generally contain enough phosphorus to grow healthy lawns



without any added fertilizer (NVSWCD, 1994). However, almost all retail lawn fertilizer products do contain phosphorus. Some local soil conservation districts are now offering special no-phosphorus formula fertilizers to homeowners. In general, most experts agree that most lawn soil contains enough phosphorus to meet plant demand.

A soil's ability to store nitrogen in organic forms rises as organic matter increases. An undisturbed lawn usually adds organic matter (and thus increases nitrogen storage) until equilibrium is reached. One study showed that nitrogen accumulated rapidly in the surface layer for the first 10 years, and then was little changed after 25 years (Petrovic, 1990). This suggests that prior fertilization history or soil testing are important for determining appropriate fertilization rates and reducing the potential for nitrogen leaching.

#### *Storage Component 2: Thatch Storage*

Thatch is a brown layer of plant parts which rests on top of the soil. Thatch is composed of dead roots, stolons, and rhizomes. The amount of thatch present is highly variable, since thatch buildup can be caused by poor soil conditions and/or poor lawn management. In cases of extreme thatch buildup, a lawn may actually be rooted in the thatch layer rather than the underlying soil. Some studies provide nitrogen recovery data for stems, leaves, roots, and "debris" combined, but they do not report the amount of thatch present. In general, however, little data are available on nutrient storage in the thatch layer. One study reported a 14 to 21% recovery rate of applied nitrogen in the thatch layer (Petrovic, 1990).

#### *Output 1: Volatilization*

Some of the inorganic nutrients applied to the lawn never reach plants. Instead, they volatilize and return to the atmosphere, often during or shortly after fertilization. Petrovic (1990) reviewed literature reporting total atmospheric losses of applied nitrogen which ranged from zero to 93% of applied nitrogen. Highest rates of volatilization are associated with applications of urea fertilizers. Urea applied to turfgrass often results in more volatilization than urea applied to bare soil. Volatilization also increases with greater thatch levels and declines when turf is irrigated.

#### *Output 2: Denitrification*

Under the right conditions, some soil bacteria can denitrify, or convert nitrates to molecular nitrogen ( $N_2$ ) which returns to the atmosphere. The question is how much nitrate is lost to denitrification rather than leaching or plant uptake. Limited studies of lawn denitrification indicate that if soils are saturated and temperatures are high, significant denitrification can occur. For example, Petrovic (1990) reports that 45% of applied

nitrogen on silt loam and 93% on silt soil denitrified, and was lost to plants.

#### *Output 3: Surface Runoff*

Relatively little monitoring data is available to characterize loss of nutrients in surface runoff from lawns. Only one study has measured phosphorus concentrations in lawn runoff (Bannerman, 1994). This Wisconsin study found total phosphorus concentrations were as high as 2.6 mg/l in lawn runoff, ranking as the highest urban source area for that nutrient. Three studies have detected nitrate in surface runoff from turfgrass plots. Morton *et al.* (1988) detected nitrate at one to 4 mg/l from simulated lawns in Rhode Island, but noted that runoff only occurred twice during his two year study, once during a rain on snow event and the second time during a very intense storm. Gross and his colleagues (1990, 1991) found minimal nitrate concentrations in his Maryland turfgrass test plots, except when fertilizer applications coincided with large storm events. Hipp *et al.* (1993) reported a 3% nitrate loss in test lawns in runoff from a storm two days after fertilization, but found negligible concentrations in xeriscaped plots.

The scarcity of nutrient runoff from grass reflects the fact that surface runoff is a relatively rare event in turfgrass research. Well maintained turfgrass seldom produces surface runoff, except during uncommonly intense storm events. Test plots also have ideal soil conditions. The same controlled and well-managed conditions probably do not exist at all home lawns. Many lawn soils are highly compacted, and have runoff coefficients ranging from 0.05 to 0.25 (see article 129). In addition, the travel distance for runoff between the lawn and an impervious area may also be short. Certainly, it is not hard to find home lawns with compacted soil, bare spots, steep slopes, channel flow, thin turf, and fertilized sidewalks.

#### *Output 4: Subsurface Leaching*

Turfgrass researchers have performed more studies on the possible extent of nitrate leaching from simulated urban lawns (for a summary, see article 132). Leaching occurs when excess inorganic nitrogen moves below the root zone, and travels in solution through soil water, eventually reaching a stream or moving into deep groundwater. The experiments specifically examined some of the poor management factors thought to occur on home lawns, most notably over watering and overfertilization. In controlled studies, the average concentration of leached nitrate under home lawns that were not fertilized was about 0.5 mg/l. Leachate from lawns that were overfertilized ranged from 1 to 4 mg/l in the experiments.

The greatest leaching occurred when lawns were overfertilized and overwatered at the same time. In this situation, high nitrogen inputs are more susceptible to leaching because the overwatering sharply increases

percolation through the soil. The highest rates of nitrate leaching have been recorded from golf courses that have been continuously fertilized for many decades (Cohen *et al.*, 1990). Average concentrations of 1 to 6 mg/l were recorded in test wells. In most cases, nitrate leaching is also very pronounced in sandier soils that have rapid infiltration rates. Densely populated Long Island relies on groundwater that is overlain by sandy soils, and groundwater nitrate concentrations there have risen significantly over the last 30 years. Leaching of fertilizers is thought to be a significant contributing source (Bormann *et al.*, 1993).

#### *Output 5: Clippings*

Grasses rapidly take up inorganic nitrogen and phosphorus and incorporate them into biomass. When lawns are mowed, this biomass is harvested in the form of clippings. Over the course of a year, the 20 to 30 lawn "harvests" can remove a significant quantity of organic nutrients from the lawn—up to 235 pounds of nitrogen and 77 lbs of phosphorus per acre are "lost" in clippings (Meyer, 1995). If the clippings are left in place (or mulched by a composting lawn mower) the organic nutrients are returned to the soil and thatch layer, where some fraction is eventually transformed into more available inorganic forms. In this case, clippings become a nutrient storage component. If, on the other hand, clippings are bagged and exported as yard waste, the nutrients contained in clippings become an output. In addition, any clippings that are discharged from the lawn to the driveway or street also represent an output of nutrients from the system.

#### **Nutrient Concentrations in Urban Streams**

The brief review of the lawn nutrient cycle certainly indicates the potential for leaching or runoff of nutrients as a loss mechanism. The key question is whether these nutrient losses are great enough to increase nutrient levels within urban streams, either during runoff events or in dry weather flow. One indirect means of answering this question is to look at the actual nutrient concentrations in streams that drain residential watersheds that might be influenced by lawn care activity. Nutrient levels in urban streams, of course, represent a composite of many different sources and pathways, of which lawn care is but one. For example, washoff of deposited nutrients from impervious areas is thought to be a major source of nitrogen and phosphorus during storms (MWCOG, 1983). Some insights about the possible role of lawn care may have in regard to stream nutrient levels can be gained from an analysis of the runoff from residential watersheds.

Some indication of the typical concentrations of nitrate and total phosphorus in stormwater runoff are evident in Figures 2 and 3. These graphs profile the average event mean concentrations (EMCs) in storm runoff recorded at 37 residential watersheds or

catchments across the United States. The sites represent a very broad geographic base, and include runoff monitoring data from 15 states (WA, SD, VA, NC, MD, IL, MI, WI, MN, KS, FL, CO, GA, TX, CA). This database includes 12 NURP and 25 post-NURP runoff monitoring studies, that collectively sampled several hundred individual storm events. Most of the residential watersheds were less than 200 acres in size.

The average nitrate EMC is remarkably consistent among the residential watersheds—with most clustered tightly around the average of 0.6 mg/l, and a range of 0.25 to 1.4 mg/l. While the nitrate concentrations during storms are high enough to be considered moderately eutrophic, the data do not suggest much of a link between lawn care and stream quality during storms. Indeed, researchers have shown that washoff of nitrate deposited on impervious surfaces from the atmosphere can account for nearly all of the observed concentrations (MWCOG, 1983). The fact that storm nitrate concentrations do not appear to be heavily influenced by lawn care activities may only reflect the fact that nitrate leaching would be expected to impact stream quality during periods of dry weather flow.

The concentration of total phosphorus during storms is also very consistent, with a mean of 0.30 mg/l, and a rather tight range of 0.10 to 0.66 mg/l (Figure 2). About 40% of the observed phosphorus was found in soluble forms that are biologically available. Phosphorus concentrations of this magnitude are generally considered to be moderately eutrophic, and are comparable to those seen in agricultural streams (Smith *et al.*, 1992). It is quite possible that the elevated phosphorus concentrations seen in residential storm runoff could be partly influenced by lawn care activities, as the only other major source, atmospheric deposition, generally can only account for about a quarter of the observed TP concentration (MWCOG, 1983). Whether the remaining phosphorus is a direct result of fertilization, or an indirect result of erosion of phosphorus-rich organic matter (clippings, pollen, leaves or soils), or some other unknown pathway is a matter of conjecture.

We know next to nothing about nutrient dynamics in urban streams during periods of dry weather. This monitoring gap prevents us from detecting whether nitrate concentrations are in fact elevated by lawn leaching during the non-growing season (when nitrate leaching is typically highest). A cursory sample of nitrate trends does indicate that levels were typically higher in baseflow (0.72 to 2.2 mg/l) than during storms, but the sample size is too small to draw any firm conclusions. Interestingly, the handful of baseflow total phosphorus observations indicate that TP levels drops sharply during dry weather periods (0.02 to 0.07 mg/l).

The USGS has recently completed a national assessment of nutrient levels at over 300 urban, agricultural, range and forest watersheds (Smith *et al.*, 1992). Most of the samples were collected during baseflow



conditions, although some storm data were included in their summary statistics. Urban streams were found to have the second highest nitrate and total phosphorus levels, second only to agricultural streams. In particular, urban phosphorus levels were frequently as high as those found in many agricultural areas, except for intensive row crops.

Our historical approach to monitoring, however, has never allowed us to really test the hypothesis that urban lawn fertilization directly contributes to elevated nutrient levels in streams. Systematic monitoring of dry weather nitrate concentrations of urban streams, coupled with detailed watershed surveys of residential fertilizer use would permit a test whether these links exist. Similarly, a more experimental sampling program might detect the source of total phosphorus in urban storm runoff. The sampling approach could involve test plots of fertilized and unfertilized lawns adjacent to streets, with an experimental device that allows the investigator to allow or block lateral movement of organic matter from the lawns to the street. More targeted monitoring programs are clearly needed to define the lawn/stream nutrient interactions.

### Nutrient Impacts

Although the role of urban lawn care remains somewhat of a mystery, a number of conclusions can be made about nutrient concentrations in urban streams. On one hand, monitoring has never shown a single exceedance of the 10 mg/l nitrate criteria for drinking water, and therefore, urban runoff is not much of a risk to potable water supplies. On the other hand, concentrations of total nitrogen and phosphorus in urban runoff are certainly high enough to trigger eutrophication (or over-enrichment) in nutrient sensitive surface waters. In this respect, urban watersheds that drain to oligotrophic or mesotrophic lakes (where phosphorus is the limiting nutrient) or poorly flushed coastal waters and estuaries (where nitrogen is limiting) appear to be most vulnerable to eutrophication. The impact of elevated nutrient levels on small streams and their substrates have not been extensively explored, but several researchers have reported changes in periphyton growth in urban streams.

### Needed Research

For all the runoff research done on experimental turfgrass plots, we know very little about actual lawns. There are more real world data on complex natural ecosystems such as forests and wetlands than on the comparatively simple lawn. Experimental results are extended to home lawns without benefit of basic information on the differences between homeowner-managed lawns and professionally-managed test plots. Simple small watershed studies in different regions could provide valuable information on important char-

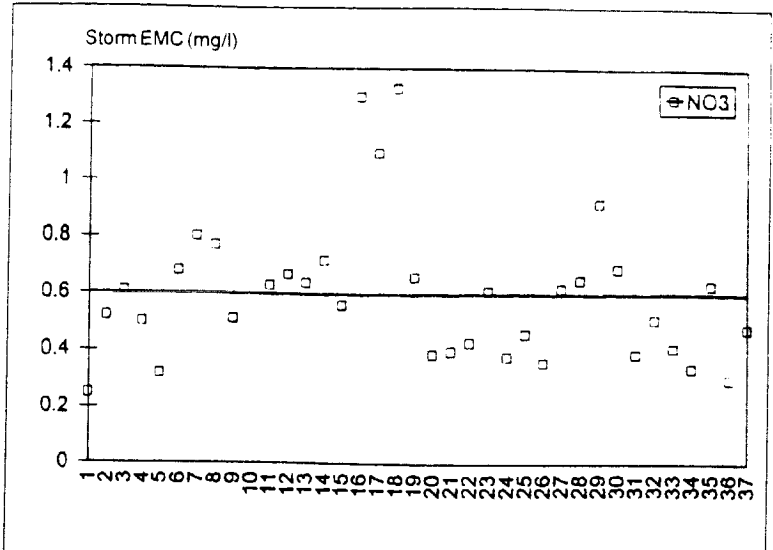

Figure 2: Nitrate-Nitrogen Concentration in Stormwater Runoff (Mean EMCs) (37 Residential Watersheds Across U.S.)

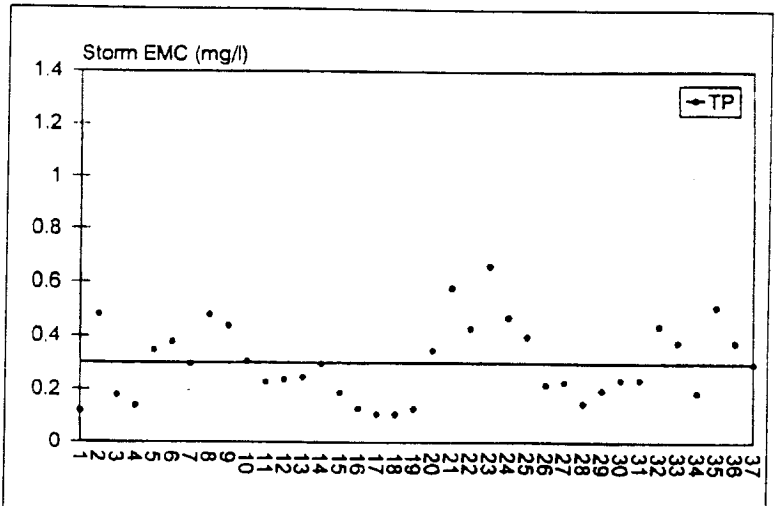

Figure 3: Total Phosphorus Concentration in Stormwater Runoff (37 Residential Watersheds Across U.S.)

acteristics such as soil condition, turf density, thatch levels, slopes, and plant diversity. Ideally, such studies would also take place in communities of varying economic characteristics. Even without actual runoff data, a better characterization of lawns would aid interpretation of the existing body of experimental results.

### Summary

We are presently unable to accurately quantify the impact lawns have on stream water quality. Nonetheless, techniques are available to minimize the potential

for nutrient and pesticide exports from turf areas. Requiring no construction or engineering, these techniques can in fact save homeowners time and money. The prudent course, therefore, is to help homeowners adopt this new approach to lawn care. See also articles 126, 130, 131 and 132.

- CAB

#### References

- Aveni, M. 1994. "Homeowner Survey Reveals Lawn Management Practices in Virginia." *Watershed Protection Techniques* 1(2): 85-86.
- Bannerman, R. 1994. "Sources of Urban Stormwater Pollutants Defined in Wisconsin." *Watershed Protection Techniques*. 1(1): 30-32.
- Bormann, F., D. Balmori, and Gordon T. Geballe. 1993. *Redesigning the American Lawn— A Search for Environmental Harmony*. Yale University Press. Binghamton, New York. 166 pp.
- Cohen, S., S Nickerson, R. Maxey, A. Dupuy and J. Senita. 1990. "A Groundwater Monitoring Study of Pesticides and Nitrates Associated With Golf Courses on Cape Cod." *Groundwater Monitoring Review*. 1990. 160-173.
- Dindorf, C. 1992. *Toxic and Hazardous Substances in Urban Runoff*. Hennepin Conservation District. Minnetonka, MN 98 pp.
- Exner, M, M. Burbach, D. Watts, R. Shearman and R. Spalding. 1991. "Deep Nitrate Movement in the Unsaturated Zone of a Simulated Urban Lawn." *J. Environ Quality* 20: 658-662.
- Gross, C., J. Angle, and M. Welterlen 1991. "Runoff and Sediment Losses from Tall Fescue." *J. Environ. Quality*. 20:3 604-607
- Gross, C., J. Angle, and M. Wetherlin. 1990. "Nutrient and Sediment Losses From Turfgrass." *J. Environ Quality* 19(4): 663-668.
- Hipp, B. S. Alexander and T. Knowles. 1993. "Use of Resource Efficient Plants to Reduce Nitrogen, Phosphorus and Pesticide Runoff in Residential and Commercial Landscapes." *Water Science and Technology*. 28(5): 205-213.
- Jenkins, V.S. 1994. *The Lawn— A History of an American Obsession*. Smithsonian Institution Press. Washington, DC 246 pp.
- Klein, R.D. 1990. *Protecting the Aquatic Environment From the Effects of Golf Courses*. Community and Environmental Defense Assoc. Maryland Line, MD 54pp.(410)329-8194.
- Kroupa and Associates. 1995. *Westmoreland Lawn Care Survey*. 11 pp.
- Liptak, C. 1992. *Lawn Management Options to Improve Water Quality*. Somerset County, NJ. 6pp.
- Metropolitan Washington Council of Governments. 1983. *Urban Runoff in the Washington Metropolitan Area*. Final NURP Report. Dept. of Environmental Programs. Washington, DC. 212 pp
- Meyer, S. 1995. "What Do You Feed a Hungry Lawn?" *Organic Gardening*. May-June 1995:46-48
- Morton, T, A. Gold and W. Sullivan. 1988. "Influence of Overwatering and Fertilization of Nitrogen Losses From Home Lawns." *J. Environ Quality*. 17: 124-130
- Northern Virginia Soil Water Conservation District. 1994. "Please Don't Feed Our Streams." *How to Feed Your Lawn Without Overloading the Bay*. Northern Virginia Soil and Water Conservation District. 4pp.
- Olkowski, W., S. Daar, and H. Olkowski 1991. *Common-Sense Pest Control*. Taunton Press. Taunton, CT. 715 pp.
- Petrovic, A. 1990. "The Fate of Nitrogenous Fertilizers Applied to Turfgrass." *J. Environ. Quality* 19: 11-14
- Schultz, W. 1989. *The Chemical-Free Lawn— The Newest Varieties and Techniques to Grow Lush, Hardy Grass*. Rodale Press. Emmaus, PA. 194 pp.
- Smith, R, R. Alexander and K. Lanfear. 1992. "National Water Summary 1990-1991: Stream Water Quality." pp 111-140 in *USGS Water Supply Paper 2400*. Reston, VA.
- Thomas, R. and G. Greene. 1993. "Rainwater Quality From Different Roof Catchments." *Water Science Technology*. 28(3-5)291-299.

# Urban Pesticides: From the Lawn to the Stream

**T**he fate of pesticides applied to our lawns remains somewhat of a mystery. Indeed, it seems to depend on whom one talks to. The fact that an enormous quantity of pesticides is being applied to our nation's lawns is beyond dispute. A key question is whether pesticides reach urban streams either by leaching into groundwater or in stormwater runoff. On one hand, turf researchers generally report very little runoff or leaching of pesticides from carefully controlled lawn test plots (see article 129). On the other hand, stream researchers frequently detect a relatively wide range of herbicides and insecticides in dry weather and storm runoff from residential watersheds, at the part per billion level. While this finding seems to demonstrate a clear link between the input of lawn pesticides and their delivery to streams, it fails to tell how they were delivered, or what environmental risk they may pose. In this article, the available research on the use, fate and environmental significance of urban pesticides are reviewed.

## Urban Pesticide Use

The U.S. EPA estimates that nearly 70 million pounds of active pesticide ingredients are applied to urban lawns each year. Collectively, urban lawns cover an estimated 20 to 30 million acres of our country's landscape. Homeowner surveys suggests that pesticides are regularly applied on roughly half of these acres. Thus, an average acre of maintained lawn receives an annual input of five to seven pounds of pesticides.

Who applies these pesticides to the lawn? Surveys indicate that about two-thirds of all homeowners perform their own lawn care, while professional lawn care companies service the remainder (Table 1). In some residential watersheds, the fraction of lawns treated by professionals can approach 50%, particularly when lot size and income are high.

The fraction of homes that actually apply pesticides outdoors ranges from 40 to 60% in most surveys (which includes both homeowner and professional lawn care applications). About three in 10 residents report that herbicides were applied outdoors. A similar but more variable proportion of residents—20 to 40%—report using insecticides.

The diversity of pesticides applied in urban areas is staggering. Kroil and Murphy (1994a) performed an extensive survey of pesticide use in nearly 500 homes in Baltimore and found nearly 50 herbicides, insecticides and fungicides commonly applied by residents or commercial applicators (Table 2). Immerman and Drummond (1985) report that some 338 different active ingredients are applied to lawns and gardens nationally. Each pesticide differs greatly in mobility, persistence and potential aquatic impact, and is difficult to ascertain what if any environmental risk they may pose. Marketing surveys, however, indicate that a relative handful of brand name pesticides make up the bulk of most residential pesticide applications, such as 2,4-D, MCPP, diazinon and chloropyrifos.

**Table 1: Summary of Lawn Care Surveys**

Lawn Care Study	Wisconsin	Virginia	Maryland	Maryland	Minnesota
References	Kroupa	Aveni	Kroll	Smith	Dindorf
Homes surveyed	204	100	484	403	136
Take care of own lawn	69%	85%	61%	68%	63%
Professional lawn care	21%	10%	39%	32%	37%
Use pesticides	—	66%*	40%	—	—
Use insecticides	17%	—	—	42%	—
Use herbicides	29%	—	—	30%	76%*

\* Mail in survey technique may have led to over-reporting

**R0079488**

As might be expected, summer is the time of year when pesticides are most commonly applied. Most residents only make one application per year, but a small minority make up to five applications. Surveys indicate that residents make their pesticide selection and application decisions based either on a recommendation from their commercial applicator, product labels or advice from neighbors (Aveni, 1994). Lastly, while residents do show an increasing awareness about the links between lawn care and water quality, their primary objective is still a sharp-looking lawn.

#### From the Lawn Into the Stream

Pesticides can take a number of pathways to move from the lawn to the stream. Once applied, they can leave the lawn via surface runoff, leach into groundwater, or volatilize into the air (Figure 1). For the most part, most pesticides are tightly fixed on soils or thatch, where they are broken down by sunlight or microbial action (the trend in recent years has been to utilize pesticides that are relatively non-persistent, and have a half-life of days or months). For example, Branham and Weber (1985) calculated that 96% of the applied diazinon was retained in thatch and upper soil layers of lawns. Still, under the right conditions, some pesticides can migrate from the lawn (see article 133).

#### Runoff Losses

Grass turf generally produces modest runoff during most storm events (see article 133). During intense storms, however, grass can produce measurable runoff, and this runoff can carry soluble and particulate pesticides from the lawn. The greatest pesticide loss occurs when an intense storm occurs shortly after pesticides are applied. The losses of some pesticides under these conditions can be substantial. For example, Hall (1987) examined the loss of the herbicide 2,4-D in simulated runoff from sloping Kentucky bluegrass sod. Up to 90% of the 2,4-D applied was lost in runoff from a storm a few hours after initial application.

In a summary review of agricultural pesticide monitoring studies, Balogh and Walker (1992) concluded that maximum pesticide losses, under normal conditions, are on the order of:

- 1% for water-insoluble pesticides
- two to 5% for pesticides applied as wettable powders
- 0.5% for water soluble and soil incorporated pesticides.

These loss rates should be considered "worst case" numbers for most urban lawns, as they produce less runoff than row crops (where these loss rates were derived). These loss rates can be higher, of course, if an intense rain event follows application.

**Table 2: Residential Pesticide Use Survey in Baltimore Watersheds (47 Different Active Ingredients Identified) (Kroll and Murphy, 1994a)**

Acephate (I)	Lindane
Bendiocarb (I)	MCPA (H)
Benefin (H)	MCPP (H)
Carbaryl (I)	Maneb (F)
Chlorothalonil (F)	<i>Malathion (I)</i>
Chlorpyrifos (I)	<i>Propoxur (I)</i>
Diazinon (I)	<i>Pyrethrum (I)</i>
Dicamba (H)	Temephos
Fluvalinate	Trifluralin (H)
<i>Glyphosate (H)</i>	2,4-D (H)
Isofenphos (I)	
<i>Lindane (I)</i>	(+ 27 others)

*Italics indicate homeowner application only, H= herbicide, I= Insecticide, F=Fungicide*

#### Leaching

Rainfall that doesn't run off or evapotranspire leaches through the soil to groundwater, and ultimately the stream. Some soluble pesticides can be carried with the water as it makes its slow journey to the stream. Again, turfgrass researchers have shown that only small amounts of pesticides are lost to groundwater. Gold *et al.* (1988) studied the leaching of two common herbicides (2,4-D and dicamba) through the soils of several test lawns. The sandy soils of the well irrigated lawns were thought to be ideal conditions for leaching of these mobile pesticides. After several seasons of monitoring, the herbicides were still tightly fixed in soil thatch, and significant degradation had occurred in the root zone. Pesticide concentrations in leachate were always less than 1 ppb.

Balogh and Walker (1992) came to the same conclusion after reviewing agricultural monitoring studies that examined pesticide leaching. Maximum potential loss ranged from one to 2% of the applied pesticide, which translates to groundwater pesticide concentrations on the order of 1 to 3 ppb. Watschke and Mumma (1989) examined the potential leaching of dicamba, 2,4-D and chlorpyrifos on turfgrass plots. A maximum of 2% of applied dicamba and 2,4-D were lost in leachate, with most occurring in the first few days after application.

#### Drift and Deposition Onto Impervious Surfaces

A third route to the stream is the movement of pesticides ingredients that volatilize or drift away as

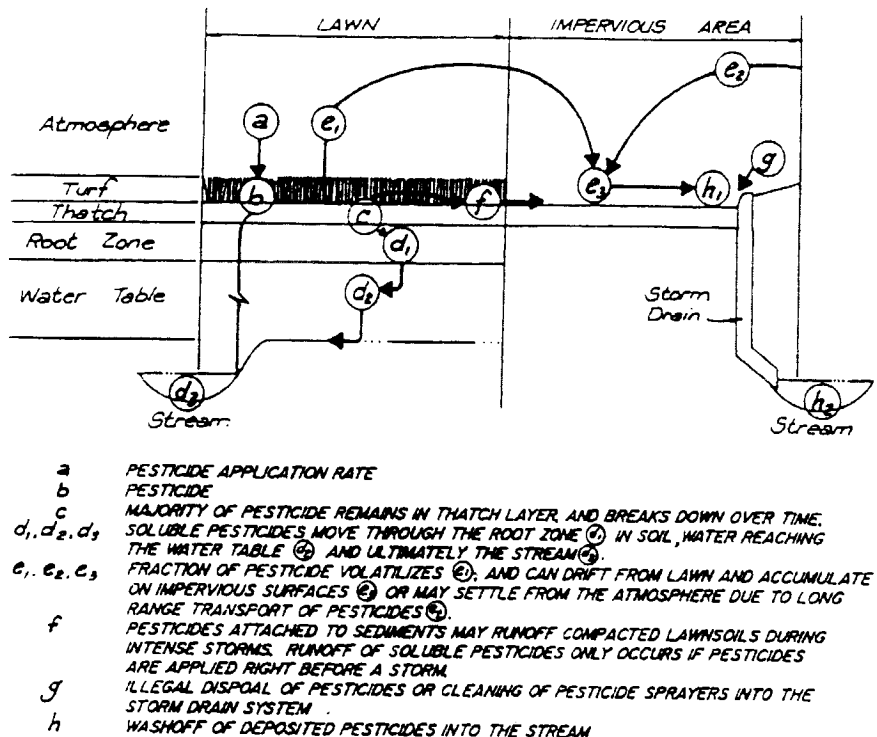

Figure 1: Urban Pesticide Pathways

they are being sprayed or applied. Depending on the nature of the pesticide and the manner that it is applied, anywhere from 2% to 25% can drift away and land on an impervious surface. During the next rainstorm, the pesticide can be quickly washed away. Pesticide drift can extend over a distance as short as a few yards or as long as several hundred miles. Glofelty *et al.* (1990) and others have studied the local and long range transport of pesticides, and have detected them in both rainfall and dustfall.

Indeed, a number of pesticides exclusively used for crops, such as Atrazine, Alachlor, Cyanazine and Metolachlor, have been detected in stormwater runoff from residential watersheds located far away from agricultural sources (Wotzka *et al.*, 1994; Kroll and Murphy, 1994a; Hippe *et al.*, 1994). In another case, rain and fog have been found to be a chief source of diazinon in the Central Valley of California, presumably due to the drift of this pesticide from nearby orchards (Connor, 1995). The studies suggest that some pesticides can reach an urban stream simply through air deposition and subsequent washoff, even if the pesticides were never applied to residential lawns. It also opens the possibility that local drift of pesticides from lawns to streets could be a significant loss pathway.

*Disposal and Sprayer Cleaning*

Pesticides can also reach the stream through im-

proper disposal or applicator cleaning. Very little is known about the significance of either pathway. The Baltimore pesticide usage survey found contradictory results (Kroll and Murphy, 1994a). On one hand, over 90% of residents claimed that they had no extra pesticides stored in their home. On the other, an even greater percentage were ignorant of how to properly dispose of excess or unused pesticides.

The Baltimore survey also found that about one in thirteen residents was likely to spray their own pesticides with an applicator (remainder handled by commercial applicators). Two-thirds of the do-it-yourselfers indicated they rinsed out their sprayers over grass, pavement or directly into gutters or storm sewers.

*Pesticides and Stormwater Practice Sediments*

One possible repository for pesticides in the urban environment are the sediments of stormwater practices, such as ponds and wetlands. Only a few investigators have examined the pesticide content in pond muck (Dewberry and Davis, 1989; MWCOG, 1983). These studies have revealed the presence of several persistent and relatively insoluble pesticides, such as aldrin, dieldrin, lindane and even DDT at low levels (usually 0.2 ppb or less).

One investigator has detected the presence of 2,4-D and diazinon in pond water, and found that wet ponds were not effective in removing these more soluble and

mobile compounds (Bannerman, 1994). This suggests that many urban stormwater practices may not be capable of effectively removing the current generation of soluble and mobile pesticides that are being applied.

### Pesticides in Urban Streams

Finding pesticides in urban stormwater is a lot like finding a needle in a haystack. To begin with, pesticide monitoring is both complex and expensive. Researchers have only recently developed analytical techniques that can detect pesticides at the part per billion or trillion level. The search is further complicated by the diversity of pesticides applied in residential watersheds, with as many as 50 different compounds routinely applied during the growing season. Each of these compounds differs in its mobility, persistence and aquatic impact. Further, the probability that a given pesticide actually reaches the stream depends on the timing of random events—the proximity of a large storm soon after pesticide application, the decisions made by dozens of different individuals regarding pesticide selection or disposal, the occurrence of pest outbreaks and so on. Lastly, only a minute amount of pesticides is likely to ever reach the stream, even under optimal delivery conditions. Therefore, the expectation is that relatively few pesticides will be detected in urban stormwater, and then at low concentrations and frequencies

Results of pesticide monitoring of residential runoff, however, runs counter to this expectation. A review of twelve recent studies indicates that a small group of herbicides and insecticides are routinely found in urban

runoff, even in different regions of the country. Not surprisingly, this group includes the most widely used and marketed pesticide compounds.

### Herbicides

A small group of herbicides is frequently detected in urban stormwater, including 2,4-D, MCPA, MCPP and dicamba (Table 3). Each of these herbicides is a frequent component of many commercial weedkiller products used by homeowners and professionals alike. These weedkillers were detected in 25 to 90% of all storm samples from two different residential watersheds in Minnesota (Wotzka, 1994). 2,4-D, perhaps the most widely used pre-emergent weedkiller, has been frequently detected at many other sites in the country. The concentration and detection frequency of these weedkilling herbicides are among the highest yet reported for any urban pesticide. Other residential herbicides are detected with less frequency and lower concentration, and include Simazine, Silvex, Diruron, and Dacthal.

### Insecticides and Fungicides

A wide spectrum of pesticides are applied to lawns and gardens to control insect pests and control diseases, but relatively few have been detected in urban runoff. Two notable exceptions include the insecticides, diazinon and chlorpyrifos, which have been found in stormwater runoff in the low part per billion range in such diverse settings as Baltimore, Sacramento, Milwaukee and Atlanta (see Table 4). Although

**Table 3: Herbicides Detected in Urban Runoff (Reported in Median Concentrations ( $\mu\text{g/l}$ ) Parentheses Indicate Maximum Values)**

Study	2,4-D	Dicamba	MCPA	MCPA	Roundup	Other
Baltimore, MD (Kroll Murphy)	0.1-0.35	NA	NA	NA	0.44	Dacthal Simazine
Bloomington, MN (Dindorf)	1.5	0.7	1.4	1.3	NA	Silvex
Minneapolis, MN (Wotzka)	(6.8)	(2.6)	(1.4)	(5.6)	NA	No others
Atlanta (Thomas)	< 9.1	NA	NA	NA	NA	—
Atlanta (Hippe)	0.05 (.63)	NA	NA	0.05 (.42)	NA	Simazine 12 others
Milwaukee (Bannerman)	Detected	ND	Detected	ND	ND	—
Alameda, CA (Connor)	NA	NA	NA	NA	NA	Diuron Simazine

ND=Not Detected, NA=Not Analyzed

concentrations are relatively low, detection is very frequent. For example, weekly stormwater sampling in an Atlanta urban watershed detected diazinon and chlorpyrifos in 89% and 65% of all samples respectively. Peak concentrations were recorded in the late Spring (see Figure 2). Connor (1995) also reported frequent detection of these two insecticides in Sacramento, CA. Other studies report the occasional presence of carbaryl, malathion and aldrin in urban runoff. No fungicides have been detected.

#### Banned Pesticides

Researchers still find low levels of many insecticides whose use has been severely restricted or banned for many years. These include chlordane, lindane, heptachlor, dieldrin, endrin and even DDT and its residuals (Table 5). Detections are made during both wet and dry weather flows, with detection frequencies ranging from two to 25%. Their presence in urban streams after so many years appears to reflect either the slow movement of these persistent pesticides through groundwater to the stream, or the erosion of contaminated soils. This phenomenon is typified by chlordane, an insecticide whose use has been banned for over a dozen years. It is still found in groundwater and stormwater samples in most environments where it has been tested for, albeit at low levels. Cohen et al (1990) found chlordane in 44% of test wells near a golf course in New England that had regular applications of this pesticide in the past. Thomas and McClelland (1994) have detected chlordane in urban streams in the Atlanta area in about 15% of all samples, but have never detected it in samples taken from stormwater outfall pipes. Kroll and Murphy (1994) have occasionally detected it in several Baltimore streams. D'Andrea and Maunders (1993) report lindane and dieldrin in residential, commercial and industrial runoff in Toronto, Canada. The continued presence of these persistent pesticides in urban streams so many years after they were banned is a potent reminder of the long term impact of organo-haline pesticides.

#### The Risks of Pesticides in Urban Streams

The mere presence of pesticides in urban runoff does not always mean that they exert a toxic effect on to downstream aquatic communities. Indeed, most of the pesticides found in urban are present in concentrations of a few parts per billion or less. Do these concentrations really pose a risk to aquatic health? In general, the concentrations of most herbicides and banned pesticides in urban runoff appears to be well below the threshold for acute toxicity for most aquatic and terrestrial organisms (Murphy, 1992). The potential for chronic or sublethal toxicity for herbicide concentrations typically found in urban runoff is not well documented. Some formulations of weedkillers have been shown to be toxic to some fish and algae species. Even low

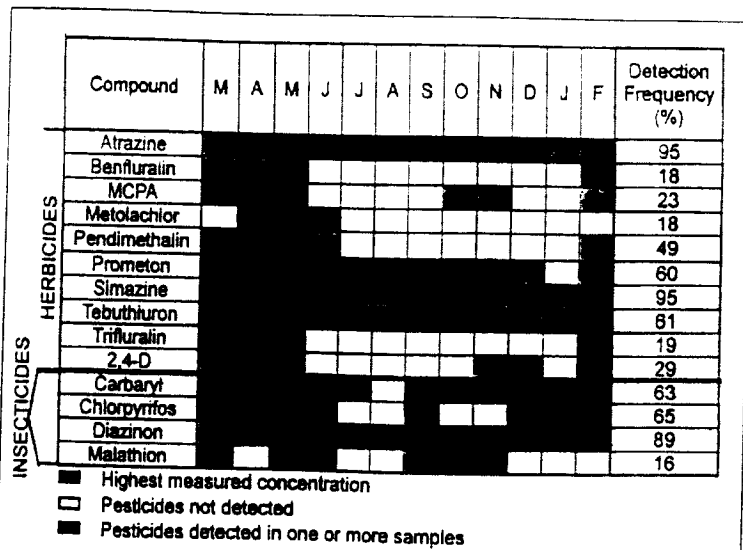

Figure 2: Seasonal Pesticide Concentration in Urban Streams in Atlanta, Ga (Hippe et al. 1994)

concentrations can inhibit algal photosynthesis, and can potentially harm downstream aquatic plants.

The greatest risk of toxicity appears to lie with the two insecticides found commonly in urban stormwater—diazinon and chlorpyrifos. Recent studies in Sacramento have shown acute toxicity for diazinon in 100% of urban stormwater samples when *Ceriodaphnia* was used as the test organism (Connor, 1995). Diazinon concentrations were typically on the order of 0.5 to five parts per billion, which is well within the reported range in other regions of the country. Acute toxicity was not found for the same test organism in Milwaukee Pond water with diazinon concentrations that were an order of magnitude lower (Bannerman, 1994).

Connor also found chlorpyrifos to be acutely toxic for several runoff samples that had concentrations in

Table 4: Currently Used Insecticides Found in Stormwater Runoff (Reported in Median or Mean Concentrations in µg/l) (Numbers in Parentheses Indicate Maximum Reported Value)

Study Site	Diazinon	Chlorpyrifos	Others
Baltimore, MD Kroll/Murphy 94a	ND	0.021	—
Baltimore, MD Kroll/Murphy 94b	ND	0.01	—
Atlanta, GA Hippe et. al 94	0.02 (0.45)	0.008 (0.051)	Sevin (carbaryl) Malathion
Sacramento, CA Connor, 95	0.5 to 1.0	Detected	Malathion
Milwaukee, WI Bannerman, 94	0.5	NA	Aldrin

**Table 5: Banned or Restricted Insecticides Found in Stormwater Runoff—Concentrations in µg/l (ppb)**

Study	Chlordane	Lindane	Dieldrin	Other
Baltimore Kroll/Murphy	0.52	0.18	2.44	—
Rhode Island Cohen	Detected	NA	NA	NA
Atlanta Hippe	NA	0.01 (0.048)	NA	—
Atlanta Thomas	Detected	NX	NX	heptachlor
Milwaukee Bannerman	Detected	Detected	Detected	DDT,DDE
Washington MWCOG	0.2	0.2	0.2	heptachlor
Northern VA Dewberry and Davis	ND	Trace	ND	Endrin
Toronto D'Andrea	NA	0.5 to 2	0.1 to 2	—

ND=Not Detected, NA=Not Analyzed, NX= Detection only reported if they exceeded water quality standards.

the parts per trillion level. The toxicity of these two insecticides is not surprising, as a quick look at the product label or a toxicity table will show. Indeed, the use of diazinon is no longer permitted on golf courses, although it can still be used on residential lawns. Its toxicity to terrestrial wildlife, such as geese, songbirds, amphibians is well documented (article 133).

Future toxicity testing of residential stormwater runoff should clarify whether diazinon and chlorpyrifos are a problem in other parts of the country. Some recent research in the Santa Clara Valley of California suggests that residential runoff, once thought to be relatively benign, may be much more toxic than previously thought (Cooke *et al.*, 1995). Seventy percent of residential runoff samples were found to be highly or extremely toxic using *Ceriodaphnia*. The authors ruled out metals as the cause of toxicity in residential runoff, and strongly suspect that insecticides are the culprit.

#### Needed Research

Monitoring has demonstrated a clear link between pesticides applied to the lawn and their presence in the stream in many geographic regions of the country. The small group of herbicides and insecticides that are detected in urban runoff are also among the most widely sold lawn care products. While this link certainly justifies efforts to reduce pesticide use on home lawns,

more research is needed to fully understand the biological significance of the relatively low pesticide levels found in streams.

To answer these questions, a monitoring study is needed that simultaneously measures residential pesticide use, pesticide concentrations in streams during periods of maximum application, and toxicity based on rapid bioassays. Another research priority is a monitoring assessment that compares residential pesticide concentrations from traditional lawn practices and those that employ integrated pest management (IPM) or eliminate pesticide application altogether. This research could help document whether education and community outreach efforts can produce meaningful reductions in urban stream pesticide levels. **See also articles 16, 129 and 133.**  
—TRS

#### References

- Aveni, M. 1994. "Homeowner Survey Reveals Lawn Management Practices in Virginia." *Watershed Protection Techniques*. 1(2): 85-86.
- Balogh, J.C. and W. Walker. 1992. *Golf Course Management and Construction — Environmental Issues*. Lewis Publishers. Ann Arbor, MI. 952 pp.
- Bannerman, R. 1994. *Unpublished Data on Diazinon Concentrations and Toxicity in Stormwater Ponds*. Bureau of Water Management. Wisconsin DNR. Madison, WI.



- Branham, B and D. Weber. 1985. "The Fate of Diazinon Applied to Thatched Turf." *Agronomy Journal*. 77(1):101-104.
- Cohen, S. S. Nickerson, R. Maxey, A. Dupuy and J. Senita. 1990. "A Groundwater Monitoring Study for Pesticides and Nitrates Associated With Golf Courses on Cape Cod." *Groundwater Monitoring Review*. 5: 166-173.
- Connor, V. 1995. *Pesticide Toxicity in Stormwater Runoff*. Technical memorandum. California Regional Water Quality Control Board. Central Valley Region. Sacramento, CA. 30 January, 1995.
- Cooke, T, D. Drury, R. Katznelson, C. Lee, P. Mangarella, K. Whitman. 1995. *Stormwater NPDES Monitoring in Santa Clara Valley*. ASCE Engineering Research Foundation. Crested Butte, CO.
- D'Andrea, M and D. Maunder. 1994. *Characterization of Urban Nonpoint Source Discharges in Metropolitan Toronto*.
- Dewbery and Davis. 1989. *Toxicity of Sediments from BMP Ponds*. Final Report. Prepared for Northern Virginia Planning District Commission. Annandale, VA. 26 pp.
- Dindorf, C. 1992. *Toxic and Hazardous Substances in Urban Runoff*. Hennepin Conservation District. Minnetonka, MN. 98 pp.
- Glotfelty, D. E. Williams, H. Freeman, and M. Leech. 1990. "Regional Atmospheric Transport and Deposition of Pesticides in Maryland." In Kurtz, D. (eds) *Long Range Transport of Pesticides*. Lewis Publishers. Chelsea, MI. pp. 199-221.
- Gold, A., T. Morton, W. Sullivan and J. McClory. 1988. "Leaching of 2,4-D and Dicamba from Home Lawns." *Water Air and Soil Pollution*. 37. 121-129.
- Hall, C., C. Bowley and G. Stephenson. 1987. "Lateral Movement of 2,4-D From Grassy Inclines." *Proceedings British Crop Protection Conference*. 2(3):593-599.
- Hippe, D, D. Wangsness, E. Frick and J. Garret. 1994. *Pesticide Monitoring in the Apalachicola-Chattahoochee-Flint River Basin*. US Geological Survey. National Water Quality Assessment Program. Water Resources Investigation Report. 94-118. Atlanta, GA.
- Immerman, F and D. Drummon. 1985. *National Urban Pesticide Applicators Survey*. Research Triangle Institute. Publication No. 2764/08-01F.
- Kroll, J and D. Murphy. 1994a. *Residential Pesticide Usage Survey*. Water Management Administration. Maryland Department of Environment. Baltimore, MD. 60 pp.
- Kroll, J. and D. Murphy. 1994b. *Pilot Monitoring for 14 Pesticides in Maryland Surface Waters*. Maryland Dept. of Environment. Chesapeake Bay Program Technical Report. 93-020. 108 pp.
- Kroupa and Associates. 1995. *Westmorland Lawn Care Survey*. Prepared for City of Madison, Wisconsin. 26 pp.
- Metropolitan Washington Council of Governments. 1983. *Urban Runoff in the Washington Metropolitan Area: Final NURP Report*. Department of Environmental Programs. Washington, DC. 222 pp.
- Murphy, R. 1992. "Aquatic and Terrestrial Toxicity Tables." In Balogh and Walker. *Golf Course Management and Construction: Environmental Issues*. pp.519-938.
- Smith, J. S. Paul, C. Collins, A. Cavacas, M. Lahlou. 1994. "Public Survey and Pollutant Model for Prince George's County, Maryland." *Watershed '93: Proceedings of a National Conference*. US EPA. Terrene Institute. pp. 459-465.
- Thomas, P. and Scott. McClelland. 1994. "NPDES Monitoring—Atlanta Georgia Region." In U.S. EPA. 1983. *Results of the Nationwide Urban Runoff Project*. Final Report. Vol 1. Office of Water. Washington DC.
- Watschke, T and R. Mumma. 1989. *The Effect of Nutrients and Pesticides Applied to Turf on the Quality of Runoff and Percolating Water*. Final Report. US GS ER89004. Environmental Research Institute. Penn State. College Park, PA. 64 pp.
- Wotzka, P., J. Lee, P. Capel and M. Lin. 1994. "Pesticide Concentrations and Fluxes in an Urban Watershed." *Proceedings AWRA National Symposium on Water Quality*. pp. 135-145.

R0079494

## Cars Are Leading Source of Metal Loads in California

**M**etals can follow many pathways before they become entrained in urban stormwater runoff. A recent California study sponsored by the Santa Clara Valley Nonpoint Source Program suggests that cars are the dominant loading source for many metals of concern, such as cadmium, chromium, copper, lead, mercury, and zinc.

Researchers examined the significance of various metal pathways into the Lower San Francisco Bay. Specifically, the comparative loading potential of five urban source areas were studied using a mass balance approach. The sources were atmospheric deposition, automotive leaks and wear, runoff from industrial and residential sites, and water supply.

Cars and other vehicles were found to produce over 50% of the total load of three metals: copper, cadmium and zinc. This number was generated even without accounting for tailpipe emissions that produce further atmospheric deposition of metals. For example, 50% of the total copper load to the Bay was attributed solely to brakepad wear.

Atmospheric deposition accounted for an additional 25% of the total copper load, much of which came from mobile emission sources, such as cars. Copper consistently ranks as a metal of great concern because it can be acutely toxic to aquatic species even at low concentrations.

Another major metal loading pathway was the wear and tear of automobile tires. The authors conclude that tire wear alone could account for at least half of the total cadmium and zinc loads delivered to the Bay each year. Since both brakepads and tires wear directly onto impervious surfaces, it is likely that the delivery of the metals into the storm drain system is almost 100%.

The authors note that the most effective, and perhaps the only, technique to reduce copper, cadmium, and zinc loads would be to get the automotive industry to reduce the metal content of tires and brakepads. This "pollution prevention" approach has historically worked in such cases as unleaded gas and engine coolants.

Atmospheric deposition, however, remains the primary loading pathway for lead. The chief culprit appears to be exhaust from diesel-fueled vehicles. Diesel fuel exhaust also factored as a significant source for chromium, silver, mercury, copper, and zinc. Again, a pollut-

ant prevention strategy that focused on cleaner fuels or reducing vehicle emissions was recommended.

The authors made an attempt to calculate metal loadings from leaks of motor oil, gasoline, and coolant leaks from cars, as well as illegal disposal from oil and coolant changes. The data on leak and illegal disposal rates is extremely sketchy. For example leak rates of 0.3, 0.01, and 1.2% of all cars were cited for gasoline, motor oil and coolant, respectively. The rate of illegal disposal of motor oil was estimated to be 15%.

Based on these rates, leaks and illegal disposal were not believed to be a major pathway for metals into stormwater drains (about eight and 2% of the copper and zinc load, respectively).

The metal load contained in stormwater runoff from industrial sources could not be calculated due to a lack of data. However, the authors ranked the potential importance of different industrial source areas to contributing metal loads. The industrial categories with the highest risk for metal loading included mining activities, metal plating and galvanizing operations, metal scrap processing, boat building/repair, and automotive repair. Automotive repair was by far the most prevalent "industrial" activity in the basin.

—TRS

### Reference

Santa Clara Valley Nonpoint Source Control Program. 1992. *Source Identification and Control Report*. Woodward Clyde Consultants. 96 pp.

R0079495

# Sources of Urban Stormwater Pollutants Defined in Wisconsin

For the past two decades, most urban runoff monitoring activity has been focused at the end of a pipe or storm drain. Consequently, our knowledge about the concentration of pollutants in urban runoff has been confined to broad land use categories, such as residential, commercial, industrial, or combinations thereof.

With recent advances in runoff micro-monitoring pioneered by Roger Bannerman and his colleagues, we are starting to get a better resolution of the various source areas in the urban landscape that collectively contribute to the pollutant levels measured at the end of the pipe. Urban source areas include lawns, driveways, rooftops, parking lots, and streets.

Using specialized sampling devices, Bannerman *et al.* (1993) collected over 300 runoff samples from 46 micro-sites in two watersheds (Figure 1). The samplers

collected runoff from lawns, driveways, rooftops (both residential and industrial), commercial and industrial parking lots, and a series of street surfaces (feeder, collector and arterial).

Up to nine samples were collected at each of the micro-sites over a two month period, characterized by small and moderate sized rainfall events. Geometric means of pollutant concentrations were calculated for each of the micro-sites (see Table 1). Runoff volumes were obtained by hydrologic simulation models that were calibrated for each subwatershed.

The monitoring revealed that streets were the single most important source area for urban pollutants in residential, commercial, and industrial areas. Not only did streets produce some of the highest concentrations of phosphorus, suspended solids, bacteria, and several metals, but they also generated a disproportionate

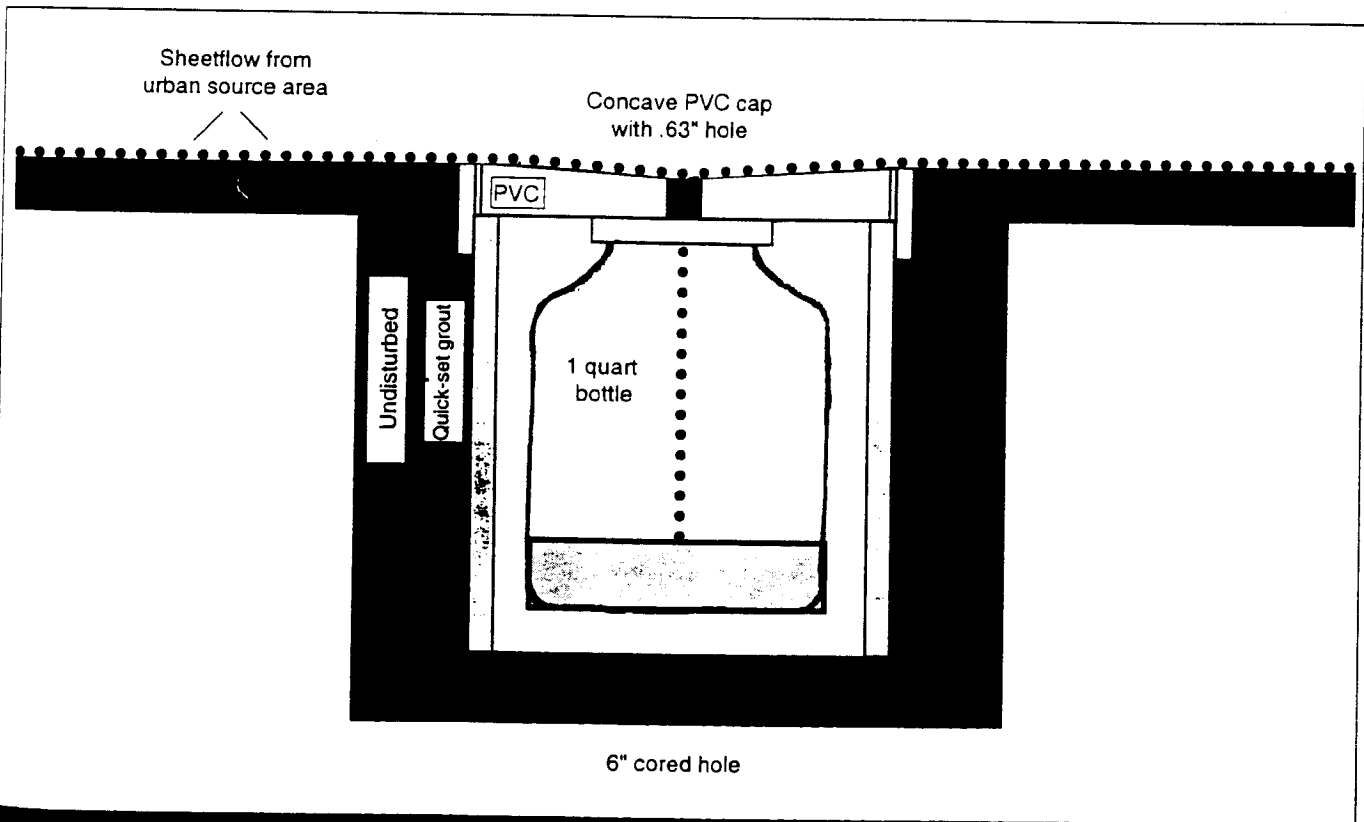

Figure 1: Diagram of a Street Sampler (Bannerman *et al.* 1993)

**Table 1: Geometric Mean Concentrations of Pollutants in Stormwater Runoff From Selected Urban Source Areas (Bannerman et al., 1993)**

Source Area	Total P (mg/l)	Solids (mg/l)	E. coli (C/100ml)	Zinc (µg/l)	Cadmium (µg/l)	Copper (µg/l)
Residential Feeder Street	1.31	662	92,000	220	0.8	46
Residential Collector Street	1.07	326	56,000	339	1.4	56
Commercial Arterial Street	0.47	232	9,600	508	1.8	46
Industrial Collector Street	1.50	763	8,380	479	3.3	76
Industrial Arterial Street	0.94	690	4,600	575	2.5	74
Residential Roofs	0.15	27	290	149	ND	15
Commercial Roofs	0.20	15	1,117	330	ND	9
Industrial Roofs	0.11	41	144	1,155	ND	6
Residential Lawns	2.67	397	42,000	59	ND	13
Driveways	1.16	173	34,000	107	0.5	17
Commercial Parking	0.19	58	1,758	178	0.6	15
Industrial Parking	0.39	312	2,705	304	1.0	41

amount of the total runoff volume from the watershed. Consequently, streets typically contributed four to eight times the pollutant load that would have been expected if all source areas contributed equally.

The importance of street runoff for urban pollutant loading is due to a number of factors. First, as streets are directly connected to the drainage system, they possess a very high runoff coefficient. Second, the curb and gutter system along streets is very effective at trapping and retaining fine particles that blow into them. In addition, as most other source areas are "upstream" from streets and their gutters, pollutants delivered from sidewalks, driveways, rooftops, and lawns ultimately pass through street gutters on their way to the storm drain.

Lastly, streets are strongly influenced by local emissions and leaks from vehicular traffic. Metals that are strongly linked to cars, such as copper and cadmium, reached their highest levels on streets and parking lots. The same pollutants were rarely encountered in roof and lawn runoff.

Rooftop runoff tended to be relatively clean. Low concentrations of phosphorus, solids, coliforms, and metals were observed. A major exception was zinc, which was found at higher concentrations in runoff from rooftops than any other source areas. This was presumably due to leaching from galvanized roofing material, particularly on flat industrial roof sites.

Runoff from lawn areas yielded the highest overall phosphorus concentrations, which may be attributed to excessive lawn fertilization. Lawns typically were a very important source area for fecal coliforms, as were

residential streets. Parking lot source areas had moderately high concentrations of all pollutants, but did not exhibit the "hotspot" levels that have been noted in other regions of the country.

As more runoff micro-monitoring data is gathered, it may soon be possible to select and size stormwater treatment practices to control the runoff and pollutants for specific source areas in the urban landscape. See also article 15.

—TRS

#### Reference

Bannerman, R., D. Owens, R. Dodds, and N. Homewer. 1993. "Sources of Pollutants in Wisconsin Stormwater." *Water Science & Technology*. (28):3-5 pp. 241-259.

# Is Rooftop Runoff Really Clean?

Three recent papers investigated the quality of runoff from different roof surfaces. Conventional wisdom holds that roof runoff is relatively clean. Its use as drinking water in rainwater cistern systems is well known. In other areas, managers maintain that cleaner roof runoff should be treated differently than runoff from dirtier parking lots and roads. This view is supported by extensive monitoring data for several conventional pollutants such as sediment, nutrients, organic matter, and possibly bacteria.

However, according to recent studies, rooftop runoff is not cleaner with respect to dissolved and particulate metals such as copper, lead, and especially zinc. Thomas and Greene (1993) sampled runoff from two kinds of roof surfaces at urban and industrial areas in Armidale, New South Wales (Australia). Good (1993) monitored runoff from five different roof surfaces in a sawmill, wood processing plant on the coast of Washington. Bannerman and his colleagues (1993) examined roof runoff samples from residential, commercial, and industrial sites in Wisconsin.

Monitoring results are compared in Table 1. As shown, industrial roofs had zinc levels that were two to 20 times greater than other urban source areas and often exceeded acute toxicity for aquatic life. It appears that galvanized roofing materials are a prime source of zinc in the urban landscape. Roofing materials, paints, and coatings are also suspected of being important sources of copper and lead as well. Roofs with copper flashing were found to have copper and lead concentrations up to six to eight times greater than galvanized roofs.

Good (1993) also conducted toxicity studies on roof runoff from the industrial site in Washington and found that several samples were acutely toxic to rainbow trout

in bioassays. The toxicity was attributed to the rapid corrosion of galvanized metal roofs and the leaching of zinc and other contaminants. It was also thought that tar-covered roofs were a source of copper. Although Good's study only looked at the first flush from rooftops, there was evidence that toxicity remained high for up to three hours after the start of a storm. Taken together, the studies suggest that the perception that roof runoff is always a source of relatively clean water may not always hold true when industrial roof surfaces are considered. Galvanized roof coatings, in particular, appear to be a major source of zinc and other metals in the urban landscape.

The rooftop monitoring studies raise the intriguing possibility that the use of alternative roofing or roof coating materials could result in lower pollutant loadings. Thus, a pollution prevention approach that avoids or minimizes the use of metals in roofing materials could be an attractive solution. Further research into metal loading from urban roof surfaces will be helpful in designing these new roof surfaces.

—TRS

**References**

Bannerman, R. 1994. "Sources of Urban Stormwater Pollutants Defined in Wisconsin." *Tech. Note 15. Watershed Protection Techniques, 1(1): 30-31. 1*

Good, J.C. 1993. "Roof Runoff As a Diffuse Source of Metals and Aquatic Toxicity in Stormwater." *Water Science Technology, 28 (3-5): 317-322. 2*

Thomas, P.R. and G.R. Greene. 1993. "Rain Water Quality From Different Roof Catchments." *Water Science Technology, 28 (3-5) pp. 291-297. 3*

U.S. EPA. 1983. *Results of the Nationwide Urban Runoff Program. Vol. 1, Final Report. Washington, D.C. 200 pp. 4*

**Table 1: Metal Concentrations in Stormwater Runoff From Different Roof Surfaces in Australia, Washington, and Wisconsin (Concentrations in µg/l)**

Ref.	Land Use (N)	Roof Type	Copper	Lead	Zinc
2	Industrial (1)	Rusty Galvanized	20	302	12,200
2	Industrial (2)	Old Metal Roof (a)	11	10	1,980
2	Industrial (1)	Plywood w/Tar Paper	166	11	877
2	Industrial (1)	Tar Roof w/Aluminum Paint	25	10	297
2	Industrial (1)	Anodized Aluminum	16	15	101
3	Industrial (8)	Galvanized Iron	ND	~100	~3,600
3	Industrial (8)	Concrete Tile	ND	~90	~1,600
3	Urban (8)	Galvanized Iron	ND	~10	~50
3	Urban (8)	Concrete Tile	ND	~50	~200
1	Residential (18)	Shingles w/ Gutters	15	21	149
1	Commercial (3)	Flat Roof	9	9	330
1	Industrial (3)	Flat Roof	6	8	1,155
4	All (2,300)	Stormwater Runoff	3	140	160

R0079498

## Article 9

Technical Note #28 from *Watershed Protection Techniques*, 1(2): 88-89

# First Flush of Stormwater Pollutants Investigated in Texas

The concept of the first flush was first advanced in the early 1970s. Runoff sampling methods of this era required the collection of multiple flow and water quality samples over the duration of a storm event. As researchers examined monitoring data during storms, they discovered that pollutant concentrations tended to be much higher at the beginning of a storm compared to the middle or the end of the event.

It was reasoned that the store of pollutants that had accumulated on paved surface in dry weather quickly washed off during the beginning of the storm. Although runoff rates were greater at the middle and tail end of a storm, the store of pollutants available for washoff was depleted, and consequently the concentration of pollutants declined.

Stormwater managers quickly grasped the practical significance of the first flush phenomenon. If most of the urban pollutant load was transported in the beginning of a storm, then a much smaller volume of runoff storage would be needed to treat and remove urban pollutants. After further monitoring and modeling, the half inch rule was advanced. Essentially, the rule stated that 90% of the annual stormwater pollutant load was transported in the first half inch of runoff.

Many communities adopted this simple standard as the basis for providing water quality control in developing areas: size your stormwater practice to capture the first half inch of runoff, and you will treat 90% of the annual pollutant load. Other communities modified the treatment standard further, by requiring that stormwater practices only capture the first half inch of runoff produced from impervious areas of the site.

With the advent of sophisticated automated sampling equipment to measure stormwater runoff in the 1980s, entire storm events could be represented by a single composite sample-known as the event mean concentration (EMC). One consequence of this technological advance was that researchers were no longer analyzing multiple samples during storms, and therefore, could not examine the behavior of pollutant concentrations during individual storm events. Further research into the first flush waned, and the half-inch rule became somewhat an article of faith in the stormwater community.

Recent analysis by Chang and his colleagues (1990), however, suggests that both the first flush phenomenon

and the half-inch rule may not always hold true. Chang analyzed pollutant concentration data from over 160 storm events at seven urban runoff monitoring stations operated by the City of Austin, Texas from 1984 to 1988. The entire dataset was divided into different runoff increments (0 to 0.1 inch, 0.11 to 0.2 inch and so on). For purposes of his analysis, Chang conservatively defined the first flush as the first tenth of an inch of runoff. The pollutant concentration during the first flush was then compared to the pollutant concentration during the entire runoff event (EMC).

The results of the analysis are shown in Table 1. Shaded cells in the table indicate situations where the first flush phenomena did not occur (i.e., the storm EMC either greater than or equal to 90% of the first flush concentration). As can be seen, the first flush effect is most pronounced for sites that are highly imperviousness, but is much weaker at lower levels of imperviousness (five to 30%). For certain pollutants, such as nitrate, copper, ortho-phosphorus, bacteria and sediment, the first flush phenomena effect is weak or absent altogether.

If the first flush effect is not as strong and universal as previously thought, should it still be used as a basis for determining the volume of stormwater treatment? To answer this question, Chang performed additional modeling to determine the proportion of the annual pollutant load that would be captured under the half-inch rule (Table 2).

The analysis does suggest that the half-inch rule works effectively for sites with less than 50% impervious cover for most of the stormwater pollutants examined. However, above this threshold, the rate of pollutant load capture drops off sharply. On average, only 78% of the annual pollutant load is captured for sites with 70% impervious cover, and a mere 64% for sites with 90% impervious cover.

To put these results into perspective, consider a stormwater practice designed under the half inch rule on a 90% impervious site. Further, assume that the stormwater practice removes on average 50% of the pollutants that it captures. The net annual pollutant removal rate for the stormwater practice, however, would only amount to 32% since a large fraction of the annual pollutant load is never captured by the practice. The clear design implication is that the half-inch stormwater

practice sizing rule is not adequate for sites with high impervious cover. Communities that still utilize the half-inch rule may wish to consider other sizing alternatives.

One alternative technique to size urban stormwater practices involves basing the required treatment volume on the runoff produced from a larger storm (e.g., the 1.25 inch rainfall event) using a simple runoff coefficient. This method results in a greater treatment volume as impervious cover increases, and therefore, should avoid the key deficiency associated with the half-inch rule.

—TKS

#### Reference

Chang, G., J. Parrish and C. Souer. 1990. *The First Flush of Runoff and Its Effect on Control Structure Design*. Environ. Resource Mgt. Div. Dept. of Environ. and Conservation Services. Austin, TX.

**Table 1: First Flush Concentration As a Function of Imperviousness**  
(Mean concentration in mg/l of first tenth of an inch of runoff) (Chang *et al.*, 1990)

Pollutant	5% Imp.	30% Imp.	50% Imp.	70% Imp.	90% Imp.
BOD (5-day)	9	10	14	16	19
COD	26	52	65	66	69
Total organic C	7	13	14	18	24
NO <sub>3</sub> + NO <sub>2</sub>	0.15	0.71	0.52	0.55	0.67
Total Kjeldahl N	0.52	0.91	1.10	1.24	1.40
Ammonia	0.09	0.24	0.38	0.30	0.24
Phosphate	0.04	0.22	0.20	0.20	0.20
Total solids	80	170	212	220	123
Copper	0.01	0.01	0.01	0.01	0.01
Iron	0.36	0.68	0.48	0.54	0.58
Lead	0.004	0.045	0.03	0.04	0.06
Zinc	0.008	0.060	0.090	0.12	0.17
Fecal Coliform	9	39	28	28	31
Fecal Strep	9	30	27	27	30

Cells are shaded to indicate when the event mean concentration is within 90% of the recorded first flush concentration

**Table 2: Percent of Annual Pollutant Load Captured Using the Half-inch Rule As a Function of Site Imperviousness** (Chang *et al.*, 1990)

Pollutant	10% Imp.	30% Imp.	50% Imp.	70% Imp.	90% Imp.
BOD (5-day)	100	93	86	80	70
COD	100	97	86	80	79
Total organic C	100	94	83	82	78
NO <sub>3</sub> + NO <sub>2</sub>	100	91	84	79	72
Total Kjeldahl N	100	90	87	80	73
Ammonia	100	96	88	76	61
Phosphate	100	91	81	77	73
Total solids	100	81	75	53	43
Copper	100	93	80	76	74
Iron	100	99	81	84	66
Lead	100	99	94	83	81
Zinc	100	98	87	84	68
Fecal Coliform	100	93	83	77	62
Fecal Strep	100	91	82	75	65

# Dry Weather Flow in Urban Streams

**N**ot only does impervious cover lead to greater flooding during storms, but it is also believed to cause water levels in urban streams to decline during dry periods. An increase in impervious cover prevents rainwater from infiltrating into the soil. Consequently, the water table beneath is not resupplied, the water having been flushed away downstream rather than infiltrating through pervious surfaces to the water table.

If impervious cover significantly diminishes groundwater recharge, then not only do we have to deal with flooding and eroding of urban streams, but also the possibility that these same streams could experience severe decreases in water level in dry weather, with serious implications for habitat quality, especially for migrant species. Permanent streams may become intermittent and intermittent streams may disappear altogether.

While flood damage can be mitigated by stormwater detention practices, the problem of reduced dry-weather flows can only be approached from a whole-watershed perspective.

## **Imperviousness/Low-Flow Relationship: Difficult to Detect**

The widely held belief that imperviousness decreases dry weather flows is based on principles of groundwater hydrology. However, a cause-and-effect relationship has yet to be directly observed. According to hydrological and geological principles, stream water levels depend on the level of the water table beneath the stream, and a rise or drop in the water table depends mainly on the amount of precipitation received from the surface. Therefore, groundwater recharge and stream water level are expected to decrease correspondingly with a reduction of pervious area above ground.

Attempts to detect the effect of imperviousness on low flow are constrained by the following:

1. The need for long-term, reliable hydrological records of an area that underwent steady development. USGS gauging stations are more apt to be found on large river systems where the effects of imperviousness on low flow is less obvious. Data for smaller streams are more recent and often collected less regularly.
2. The lack of a proven method for factoring out "scale effects" is needed in large, unevenly developed urban areas where many human and natural factors are at work.
3. The added confusion of storm drains and sanitary sewers, which intercept subsurface drainage and divert storm runoff that would otherwise infiltrate the soil.

This article describes two different studies that employed a similar approach of using historical data from gaging stations and comparing urbanized and rural streams.

## **Long Island: Urbanization Linked to Lowered Base Flows**

The population of Nassau and Suffolk counties in Long Island has more than doubled since the 1940s (Simmons and Reynolds, 1982). Development has occurred as an eastward wave across the island. The paving of land was accompanied by construction of recharge basins where possible; storm sewers were built in southern Nassau and Suffolk counties. Sanitary sewer lines were constructed over time as the population and housing density increased. Treated effluent is discharged into the ocean; therefore, there is a net loss of water from the system. In Long Island, the supply of water to streams is 95% from groundwater in rural areas, 84% from groundwater in semi-urban areas (impervious cover, no sewers), and only 20% from groundwater in urbanized areas (impervious cover plus stormwater and sanitary sewers).

If the remaining 80% of the water supply to an urbanized stream is from precipitation alone, then base flow would be severely decreased in dry periods. However, there is the possibility that some water is being returned to suburban streams from lawn watering.

Reduction of base flow in highly urbanized areas compared with less urban areas was clearly shown in Long Island (Figure 1). Though there were some years of drought, variation in rainfall could not account for the general downward trend in base flow. Urbanization clearly has an effect on lowered base flow. However, impervious cover is not the only component of urbanization. Residential wells are drawing a great deal of water that is not being returned to the system. This



would also be the case even in localities where effluent is not discharged into the sea. "Used" water is generally not returned to the same area where fresh water is drawn. Thus, a community may reduce the water supply that contributes to the supply (usable or not) of lower elevations in the watershed. Whether or not there is a net loss in a watershed depends on the scale.

### North Carolina: Mixed Results

Evelt *et al.* (1994) analyzed base flow and precipitation trends at U.S. Geological Survey stations in North Carolina. Stations were chosen to reflect typical urban settings without overly large water diversions (such as power dams). Stations were classified either as "urban" or "rural" on an individual and subjective basis, rather than using a rigid measure such as population.

In the case of four urban centers and surrounding "rural" areas, both urbanized and non-urbanized streams showed decreased base flows in recent years (Evelt, 1994). While this would seem not to support the low flow/urbanization relation, the study also showed that trends in precipitation alone cannot account for the decreased flow in urban and rural streams. Regional land use effects could be exerting some negative effect on the "rural" streams as well.

Evelt offers some explanations for the mixed results from this study:

- The urbanization effect on base flow exists but may be too small for the statistics to detect.
- Some substrate types are less vulnerable to reduced groundwater recharge than others (Table 1). Raleigh and Charlotte hydrological regions are rated as intermediate in ability to sustain low flow, whereas Greensboro is low in ability to sustain low flow. (However, the Asheville region would not be rated as particularly sensitive to a reduction in recharge and yet both urban and rural stations there showed decreased base flows.)

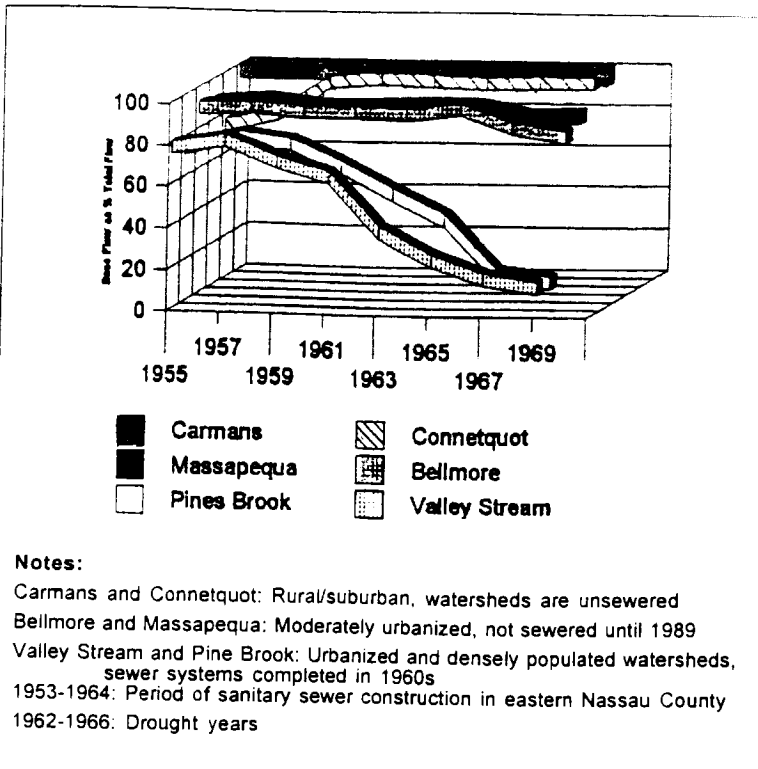

**Figure 1: Base Flow Trends in Long Island (Spinello and Simmons, 1992)**

- The streams studied were large and of mixed land use; factors outside the station area may exert an effect at the measuring point.

### What Do the Two Studies Contribute to Further Understanding of Urban Base Flows?

#### Many Elements of Urbanization

There is another possible explanation for the mixed results from the North Carolina study. The ambiguous results may have arisen from the uncertain character of the sampling sites. The sorting of stations into two

**Table 1: Analysis of Base Flow Trend in North Carolina USGS Stations**

Region	No. streams analyzed (urban, rural)	Urban streams with decreased base flow	Rural streams with decreased base flow	Urban-low flow relation shown?	Rainfall effect?	Regional substrate infiltration
Asheville	1, 1	1	1	No	No	High
Greensboro	3, 3	2 of 3	1 of 3	Yes	No	Low
Raleigh	1, 4	0	2 of 4	?	No	Moderate
Charlotte	5, 3	1 of 5	1 of 3	?	No	Moderate

categories, either "urban" or "rural," is a somewhat limited and subjective classification of watersheds. The researchers were more or less forced to use this coarse distinction without going into an exhaustive land use analysis for each watershed. Urban and rural are not absolutes in the North American landscape; there are many gradations between city and country and some rural environments contain highly urban elements and vice versa. If a more *continuous* and *quantifiable* measure of urbanization—such as percent impervious cover—could be used, then we would be more certain that the success or failure of detecting a trend reflects the real physical processes taking place and not the ambiguity of the study sites.

With the help of the powerful new methods being developed in multivariate statistics and GIS, researchers may be able to organize the mass of available data in order to classify small watersheds more precisely. Some of the variables involved include the following:

- Substrate type of the locality and surrounding area, infiltration rates
- Percent impervious cover
- Number of wells and drainfields
- Linear footage of storm and sanitary sewers
- Household water usage
- Recharge from lawn and crop field irrigation
- Water movement beneath the surface

#### **Research: Ways to Improve Detection of Imperviousness Effect on Base Flow**

- Better characterization of sampling sites: use impervious cover as a measure of urbanization. Percent impervious cover for an area is mapped from aerial photos or existing GIS data, effective impervious cover can then be derived using appropriate equations.
- Handling scale effects: apply more sensitive statistics to large watersheds or else collect data from smaller, more easily characterized sites.

#### **Management: Ways to Preserve Base Flow in Developing Areas**

- Reduce excessive parking and road surface; consider alternative designs.
- Build stormwater infiltration basins where possible.
- Given the choice of which sites will remain vegetated and which will be paved, choose the areas of highest infiltration to remain vegetated. This involves a geologist's survey.
- Road culverts and in-stream habitat structures should be carefully placed below base flow level to prevent flow interruptions in dry weather.

GIS can organize huge amounts of available data from diverse fields of research. Multivariate statistics are capable of teasing out the significant relationships from a tangle of interacting variables. Future research in this direction will hopefully discover which elements of urbanization have a significant effect on groundwater recharge and base flows in small streams.

An alternative to massive data crunching is to turn down the scale and focus on very small watersheds, such that the degree of urbanization is obvious and describable. As Evett notes, reliable long-term records will be hard to find. New sampling stations can be set up but it will take some years before enough data is generated to give reliable results.

#### *What Do We Do in the Meantime?*

Theory tells us that increased impervious cover will result in reduced base flows in streams. Direct evidence of this has been difficult to obtain. What can we assume while we wait for sophisticated statistics to tackle the large watersheds or new data to be collected from smaller watersheds? Looking at the present research, one can either assume that urbanization is not the cause of lowered base flows or one can assume - more conservatively - that until any studies report otherwise, urbanization is lowering base flows in our streams.

Where the effect was clearly shown it was also found to manifest itself rather late in the urbanization process (Spinello and Simmons, 1992). Streams will experience the more immediate effects of urbanization, such as higher flood peaks, before dry-weather flows will be reduced, simply because it takes some time for the water table to be lowered. Far from being encouraging, this tells us that by the time we notice lowered base flow it is already too late to do anything about it - the water table in that locality has been diminished. On the bright side, increased storm flows in developing areas can be a good early warning that reductions in dry-weather flow will follow. Urban planners who observe this warning have time to put a plan into action to keep streams ecologically functional year-round.

—JMC

#### **References**

- Spinello, A. G., and D. L. Simmons. 1992. "Base Flow of 10 South-Shore Streams, Long Island, New York, 1976-85, and the Effects of Urbanization on Base Flow and Flow Duration." USGS. *Water Resour. Invest. Report* 90-4205.
- Simmons, D. L., and R. J. Reynolds. 1982. "Effects of Urbanization on Base Flow of Selected South-Shore Streams, Long Island, New York." *Am. Water Resour. Assoc.: Water Resources Bulletin* 18(5): 797-806.
- Evett, J. B. 1994. "Effects of Urbanization and Land-Use Changes on Low Stream Flow." Univ. North Carolina: *Water Resour. Res. Instit. Report No.* 284.

# Multiple Indicators Used to Evaluate Stream Conditions in Milwaukee

**M**asterson and Bannerman recently reported on a long-term monitoring effort to assess the impacts of stormwater runoff on an urban creek. This effort focused on Lincoln Creek, a second order tributary draining through a highly urban portion of Milwaukee County, Wisconsin. The creek drains a watershed of 19 square miles, and is nine miles long. Lincoln Creek was selected for analysis since it had a good mix of different urban land uses draining to it. A tiered monitoring approach was employed, which combined chemical, physical, and biological monitoring efforts to assess existing conditions. The seven monitoring elements were as follows:

- Analysis of water chemistry at selected storm drain outfalls and in-stream stations
- Chemical analyses of bottom sediments at several streambed stations
- Chemical analyses of whole fish and crayfish tissues
- Use of Semipermeable Polymeric Membrane Devices (SPMDs) to estimate potential pollutant accumulation in biological tissue
- Short-term toxicity testing and long-term mortality testing
- Macroinvertebrate and fish bioassessments
- Physical habitat assessments

Data was collected both at Lincoln Creek and at a reference site for comparison purposes. The reference site was located in a non-urbanized watershed in Fond du Lac County, Wisconsin, along the East Branch of the Milwaukee River.

Stormwater samples were collected in the Lincoln Creek watershed at 10 individual storm drainage outfall locations and at one instream station (using an automated sampler at a USGS gaging station) for a total of 43 separate storm samples. Forty-four fixed interval grab samples were also collected every two weeks at the USGS station. Bottom sediments were collected at six stations in Lincoln Creek and two stations from the reference site.

Fish and crayfish were collected at both the reference site and Lincoln Creek for analysis of tissue concentrations of various pollutants. *Cyprinus carpio* (common carp) were collected where available, and *Carassius auratus* (goldfish) were substituted where carp could not be obtained. *Dacapoda* (crayfish) were

collected in all types of stream habitat and often required a stream length of 100 meters to obtain enough material for an adequate sample.

Benthic macroinvertebrates were collected at four individual locations in Lincoln Creek and two locations at the reference site. Fish sampling was done initially at one station in Lincoln Creek in 1992 and 1993; four additional stations were added for 1994 and 1995 monitoring. Fish were also sampled at the reference stream. A qualitative analysis of habitat was conducted at both Lincoln Creek and the reference site. SPMDs, incorporating a synthetic material capable of accumulating contaminants, were also deployed as a surrogate for biological organisms to verify the potential biological accumulation of pollutants in living organisms. On-site, in-situ toxicity testing was performed using a flow-through system of aquaria supplied with creek water. Chronic toxicity tests used fathead minnow (*Pimephales promelas*) exposed to creek water for 30 days. Control conditions were provided for all toxicity testing.

Lincoln Creek has over 200 stormwater outfalls discharging directly into it. Testing at the storm drain outfalls showed suspended solids and BOD<sub>5</sub> levels exceeded Wisconsin Department of Natural Resources (WDNR) effluent criteria. Two trace metals, copper and zinc, were also found to exceed toxicity criteria for warm water sport fisheries. Polycyclic aromatic hydrocarbons (PAHs) and trace metal concentrations also showed consistently high levels in the in-stream stormwater and base-flow samples. Carcinogenic PAHs exceeded water quality standards for human cancer criteria. Total recoverable copper and zinc, again, exceeded the acute toxicity criteria for warm water sport fisheries.

Sediment samples were found to have high average concentrations of petroleum by-products and trace metals. Sediment concentrations of oil and grease exceeded EPA's moderately polluted guidelines and those of the reference site (Master and Bannerman, 1994). Trace metals of surface sediment samples did not exceed EPA's heavily polluted guidelines, but copper, lead, and zinc levels in the silt fraction of the sediment did exceed the guidelines. This is reasonable given the higher absorptive capabilities of fine-grained particles over coarser grained particles. Figure 1 illustrates the comparison of storm event water and sediment concentrations with those of WDNR criteria, U.S. EPA criteria, and reference site conditions.

A. % Exceedance of Water Criteria

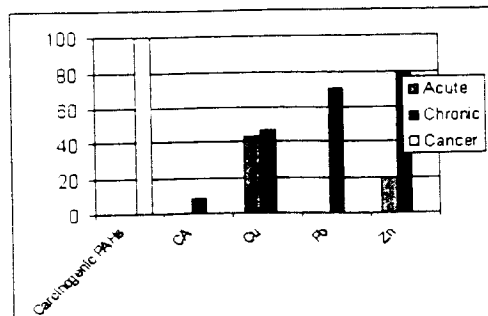

B. Sediment Pollutants

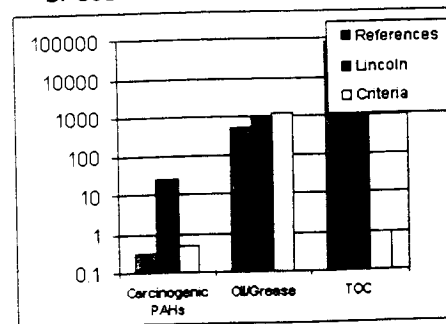

C. Particle Size Analysis

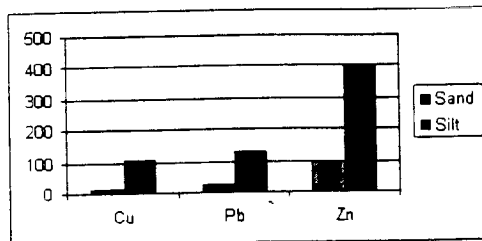

D. Heavy Metals in Silt

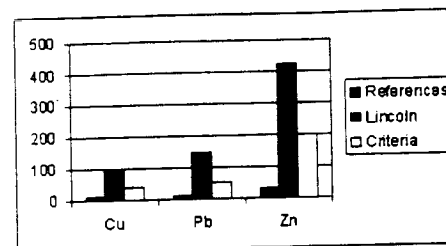

**Figure 1: Comparison of Storm Event Concentrations With Wisconsin's DNR Criteria (A), and Bottom Sediment Pollutant Concentrations With U.S. EPA Criteria and Those of the Reference Site (B, C, and D). All Units in mg/kg Dry Weight (Masterson and Bannerman, 1994)**

Pollutant tolerant species of fish and macroinvertebrates were prevalent in Lincoln Creek, whereas the reference site supported a wide variety of both intolerant and tolerant species. Fish diversity was significantly lower in Lincoln Creek, as well. Table 1 illustrates the comparison between the reference site and Lincoln Creek for fish diversity and macroinvertebrate bioassessment scores.

Analyses of fish, crayfish, and microorganisms were conducted to determine if pollutants detected in the water and stored in the sediment can bioaccumulate in aquatic organisms. Total DDT and PCBs were found in whole fish tissue samples at higher levels in Lincoln Creek than at the reference site. It was also believed that the organisms which fish feed upon can accumulate toxins. The urban crayfish tissues of Lincoln Creek had high PAH and heavy metal concentrations. Lead, in particular, was found at 40 times the rate of the reference site. Table 2 illustrates the comparison between fish and crayfish tissue pollutant concentrations between Lincoln Creek and the reference site.

SPMDs indicate that lipophilic contaminants, such as PAHs, can bioconcentrate in aquatic organisms. Extremely high levels of PAHs accumulated in SPMDs placed for two weeks in Lincoln Creek, while levels of PAHs in the SPMDs from the reference stream were two orders of magnitude lower.

Short-term toxic tests (less than eight days) appear to underestimate the toxic effects of urban stream water. Frequency of mortality in both short term laboratory or

in-situ toxicity test data was insufficient to indicate that stormwater has an effect on the stream biota. However, longer term mortality tests indicated that juvenile and adult fathead minnows (*Pimephales promelas*) exposed on-site to Lincoln Creek water for more than 14 days suffered substantial mortality (see Figure 2). This response to long-term exposure could partially explain the low quality of the aquatic ecosystem.

The qualitative habitat analysis scores reinforced the fish diversity findings and the macroinvertebrate bioassessment scores for Lincoln Creek and the reference site. Scores for Lincoln Creek were poor compared to the reference site, which rated good.

Masterson, Bannerman, and their colleagues concluded that Lincoln Creek was degraded when compared to the reference site and that the likely culprit was urban runoff. High concentrations of metals, suspended solids, bacteria, oil/grease, and PAHs were detected in storm drain outfalls and in-stream samples. Several of the pollutants found in the bottom sediments can resuspend in future storms and contribute to bioaccumulation of pollutants in macroinvertebrates and fish. The SPMD results confirm this finding.

The biological and physical habitat assessments confirmed the chemical constituent monitoring results and support a definitive relationship between degraded stream ecology and impacts from urban runoff. Toxicity testing revealed that longer term, in-situ studies are required to adequately assess the mortality of living organisms in urban streams.

While the study paints a somewhat gloomy picture of the measured impacts of urban runoff in Lincoln Creek, it illustrates the value of a comprehensive monitoring effort to quantify these influences. An obvious conclusion of the Lincoln Creek monitoring is that various method results confirm and support each other. This comprehensive approach helped establish definitive relationships between land use, instream habitat impacts, toxicity to the resident aquatic community, and instream pollutant concentrations.

The value is that other municipalities can begin to answer the questions: what is causing the toxicity, how much is too much urbanization, and can stormwater practices alleviate the conditions? Future monitoring efforts will be able to set aside the more expensive techniques, and rely on less expensive, scientifically tested, techniques to answer these questions. For example, given the cost and complexity of in-situ toxicity testing and whole fish tissue bioaccumulation testing, techniques such as SPMDs can be substituted and relied upon to establish limits of toxicity. Biological assessments using resident fish and macro-invertebrate communities can replace costly instream water chemistry monitoring. Clearly more of these comprehensive studies are needed for different size watersheds, under varied levels of urbanization to continue to define and establish these correlations. The data gained from Lincoln Creek provide a firm foundation in our quest for cost effective methods to answer difficult questions.

— RAC

#### References

- Masterson, J.P., and R.T. Bannerman. 1994. "Impacts of Stormwater Runoff on Urban Streams in Milwaukee County, Wisconsin." In *National Symposium on Water Quality*, American Water Resources Association.
- Ramcheck, J.M., and R. L. Crunkilton. 1995. *Toxicity Evaluation of Urban Stormwater Runoff in Lincoln Creek, Milwaukee, Wisconsin*. College of Natural Resources, Univ. of Wisconsin. Stevens Point, WI

Wang, L., J. Lyons, and P. Kanehl. 1995. *Evaluation of the Wisconsin Priority Watershed Program for Improving Stream Habitat and Fish Communities, Progress Report for 1995*. Wisconsin Dept. of Natural Resources, Monona.

**Table 1: Comparison of Fish Species Diversity and Macroinvertebrate Bioassessment Scores Between Lincoln Creek and Reference Site (Masterson and Bannerman, 1994)**

Biological Indicator	Parameter	Lincoln Creek	Reference Site
Fish Species Diversity	Total Fish	2	20
Macroinvertebrate Bioassessment	Total Bioassessment Score	6	24
	Condition Rating	Severely Impaired	Non-impaired

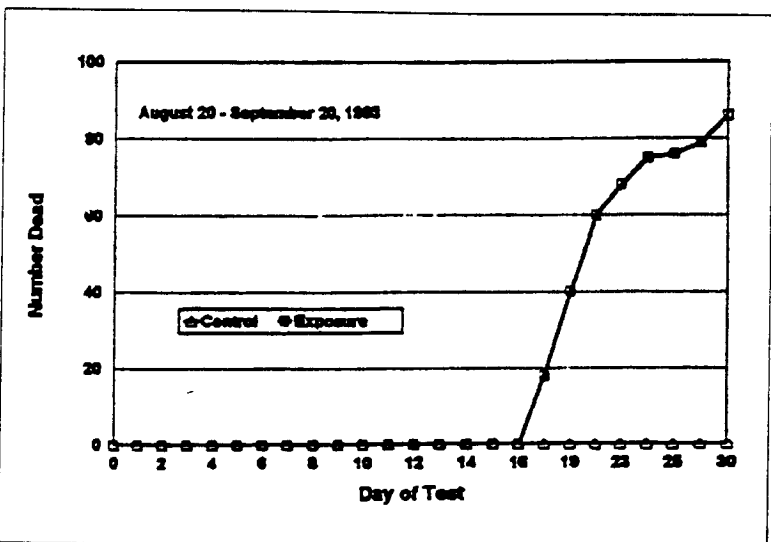

**Figure 2: Fathead Minnow Mortality in 30-day, On-site Exposure to Lincoln Creek Water**

**Table 2: Comparison of Fish Tissue and Crayfish Tissue Between Lincoln Creek and Reference Site (mg/kg), Except PAHs in (µg/kg) (Masterson and Bannerman, 1994)**

Biological Community	Stream	% Fat	Cd [0.03]	Cr [0.2]	Cu [0.06]	Hg [0.03]	Zn [0.5]	Total DDT [0.05]	Total PCBs [0.2]	Total PAHs [25.0]
Fish	Lincoln Creek		0.039	0.2	1.24	0.06	10.7	0.2	5.75	—
	Reference	8.3	ND	ND	1.3	0.14	51	ND	ND	—
Crayfish	Lincoln Creek	0.93	0.077	1.223	40.3	0.012	24	—	—	360
	Reference	0.8	0.02	ND	17.9	0.018	17	—	—	ND

# Characterization of Heavy Metals in Santa Clara Valley

**W**atershed monitoring efforts have traditionally focused on water chemistry. Watershed managers attempt to use this data to quantify temporal and spatial differences in pollutant concentrations, and by extrapolation, improvements (or declines) in water quality conditions. However, the variability of water quality monitoring data and differences in station conditions often compromise the statistical validity of observed data trends. The total cost associated with the use of traditional water quality monitoring then incurs a large, and often neglected, additional expense: statistical analysis to separate actual trends from masking variations attributable to background sources, hydrologic events, and sampling frequency.

Since 1986, the San Francisco Regional Water Quality Board has required that stormwater discharges into the southern end of San Francisco Bay be characterized

and controlled (see Figure 1). In response, 13 municipalities situated along the southern end of San Francisco Bay, Santa Clara County, and the Santa Clara Valley Water District joined together to form the Santa Clara Valley Nonpoint Source Pollution Control Program. The Program implemented a proactive watershed management effort targeting heavy metal pollution in the 700 square mile watershed, particularly in the southern end of San Francisco Bay which, in 1989, was declared an impaired water body due to frequent exceedance of heavy metal water quality standards.

The monitoring portion of the watershed management effort is built on traditional stormwater monitoring and toxicity testing. The objectives of the monitoring program include evaluation of spatial and temporal trends, land use impacts, examination of urban versus erosional sources, and comparison of automatic versus grab sampling methods.

Four years of monitoring data, representing approximately 200 station-events, were examined. Statistical analysis was used to examine differences in water quality between monitoring stations and monitoring years using analysis of variance (ANOVA) and analysis of covariance (ANACOVA). Power analysis was used to determine the number of stations and the sampling frequency required to ensure detection of long-term trends in heavy metal concentrations.

Sampling was conducted at 15 stations (see Table 1). Eleven land use stations, situated in small streams or storm drain pipes, represent relatively small catchments (12 to 8,500 acres) with one predominant land use. Water quality data from the land use stations are used to characterize urban runoff water quality. The remaining four stations, waterway stations, represent larger drainage basins (15,000 to 80,000 acres). The waterway stations are used to characterize local receiving water quality, collect compliance data, characterize upstream and non-urban metal inputs, and examine stream sediment contributions.

Automated set-ups, consisting of an automatic sampler, data logger and controller, and pressure transducer, were used to collect most of the stormwater data. Flow was rated using established flow rating curves or a weir and weir equations. Samples were analyzed for ten heavy metals (dissolved and total fraction). Various organic, inorganic, and physical parameters were also examined (see Table 2).

Heavy metal concentrations were correlated with

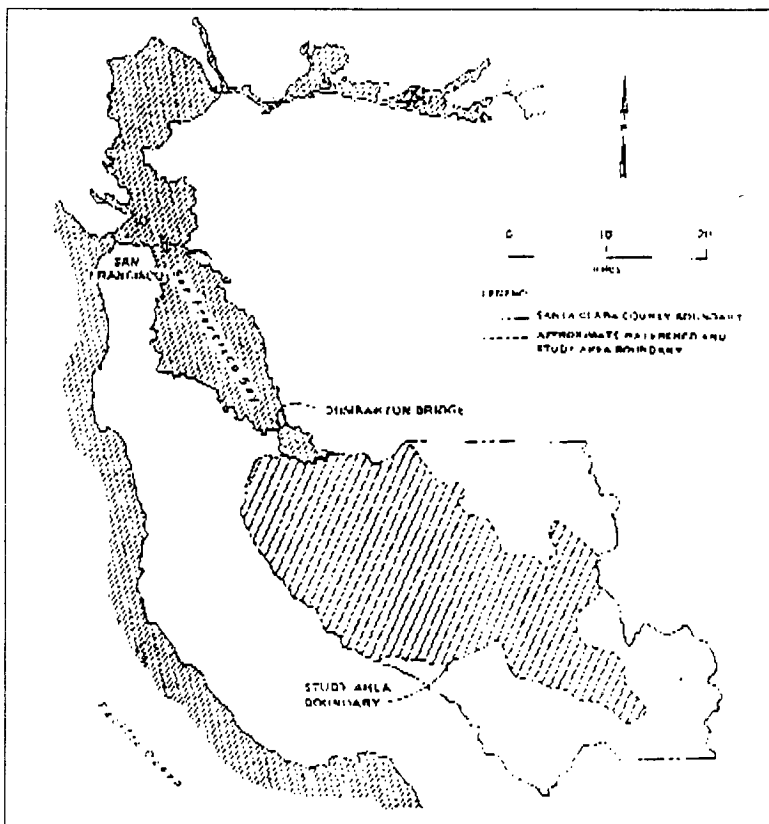

**Figure 1: Study Area**

land use using two years of data from nine of the land use stations. Data from open land use stations were also included for comparison (see Figure 2). Land use impacts were only statistically significant when land uses were grouped into three broad categories: residential/commercial, industrial (heavy and light). (Open land use was also examined for comparison purposes.) Not unexpectedly, the highest median concentrations for total zinc, cadmium, nickel, lead, and copper were associated with industrial land uses. (The heavy industrial station, which included a metal plating operation, exhibited the highest total zinc and cadmium levels.) High total nickel and lead concentrations (pollutants associated with brake line wearing, car deterioration, and automobile emissions) were also noted at the transportation stations.

The relative importance of urban versus erosional, upland sources was assessed through an enrichment analysis. Assuming that erosional sources are the only heavy metal source, enrichment analysis suggests that suspended metal concentrations would equal upland surficial concentrations and the *enrichment factor* (see Table 3) would be one. The South Bay Area, characterized by various mineral formations, contains natural erosional sources of nickel, copper, chromium, mercury, and other metals. Most of the chromium derives from these erosional sources.

The enrichment analysis results indicate that urban land uses (residential/commercial, industrial, and transportation) are the most significant sources of cadmium, lead, and zinc. Both erosional sources and urban land uses are significant sources of copper and nickel. Apparent spatial and temporal trends in the water quality data were verified using two-way analyses of variance (ANOVA) and covariance (ANACOVA). The ANOVA analysis, using total copper as a representative trace metal, focused on apparent spatial trends (differences between stations). The ANOVA analysis results indicate that stormwater runoff from the smaller, more urbanized watersheds in the South Bay area have higher total metal concentrations than the larger, less urbanized watersheds.

The ANACOVA analysis focused on differences in total metal concentrations not attributable to variations in TSS. (Much of the total metal load is associated with TSS.) It was assumed that differences in concentrations that were corrected for TSS variations were the best indicators of spatial and temporal trends. The ANACOVA results indicate that TSS concentrations are lower at stations located in constructed channels. The minimal streambank erosion results in lower TSS concentrations, which, in turn, lead to lower total metals concentrations.

A second ANACOVA analysis was performed to investigate temporal trends. Once again, copper was used as the representative metal. Copper concentra-

**Table 1: Station Descriptions**

Location	Land Use	Drainage Area (acres)
Junction Ave.	Industrial park	22
Walsh Ave.	Heavy industrial	28
Frances & Beamer Streets	Commercial	265
Hale Creek	Low-density SFR	1,633
Sunnyvale E. Channel	SFR	2,080
Pasetta and Williams	MFR	85
Stevens Creek	Open (forest)	8,410
Packwood Creek	Open (ranch land)	6,464
W. San Carlos Ave.	Industrial	40
Montague Expressway	Transportation	12
Interstate 280	Transportation	35
Calabazas Creek	Mixed	9,216
Sunnyvale E. Channel	Mixed	3,437
Guadalupe River	Mixed	15,904
Coyote Creek	Mixed	79,552

**Table 2: Monitoring Parameters**

Total metals	Dissolved metals
arsenic	cadmium
mercury	copper
cadmium	lead
nickel	mercury
chromium	silver
selenium	zinc
copper	
silver	
lead	
zinc	
	<b>Inorganic / Physical</b>
	pH
	hardness
	turbidity
	total suspended solids
<b>Organics</b>	
PAH	
total organic carbon	
total oil and grease	

**Table 3: Enrichment Analysis**

Analysis to assess the relative importance of urban versus erosional pollutant sources.

**Particulate Metal Concentration (g/L):** total metal concentration minus the dissolved metal concentration.

**Suspended Metal Concentration (g/g):** the ratio of particulate metal concentration (g/L) to TSS concentration (g/L).

**Enrichment Factor:** the ratio of suspended metal concentration (g/g) in urban stormwater runoff sample to surficial soils concentrations (g/kg) in upland areas of watershed.

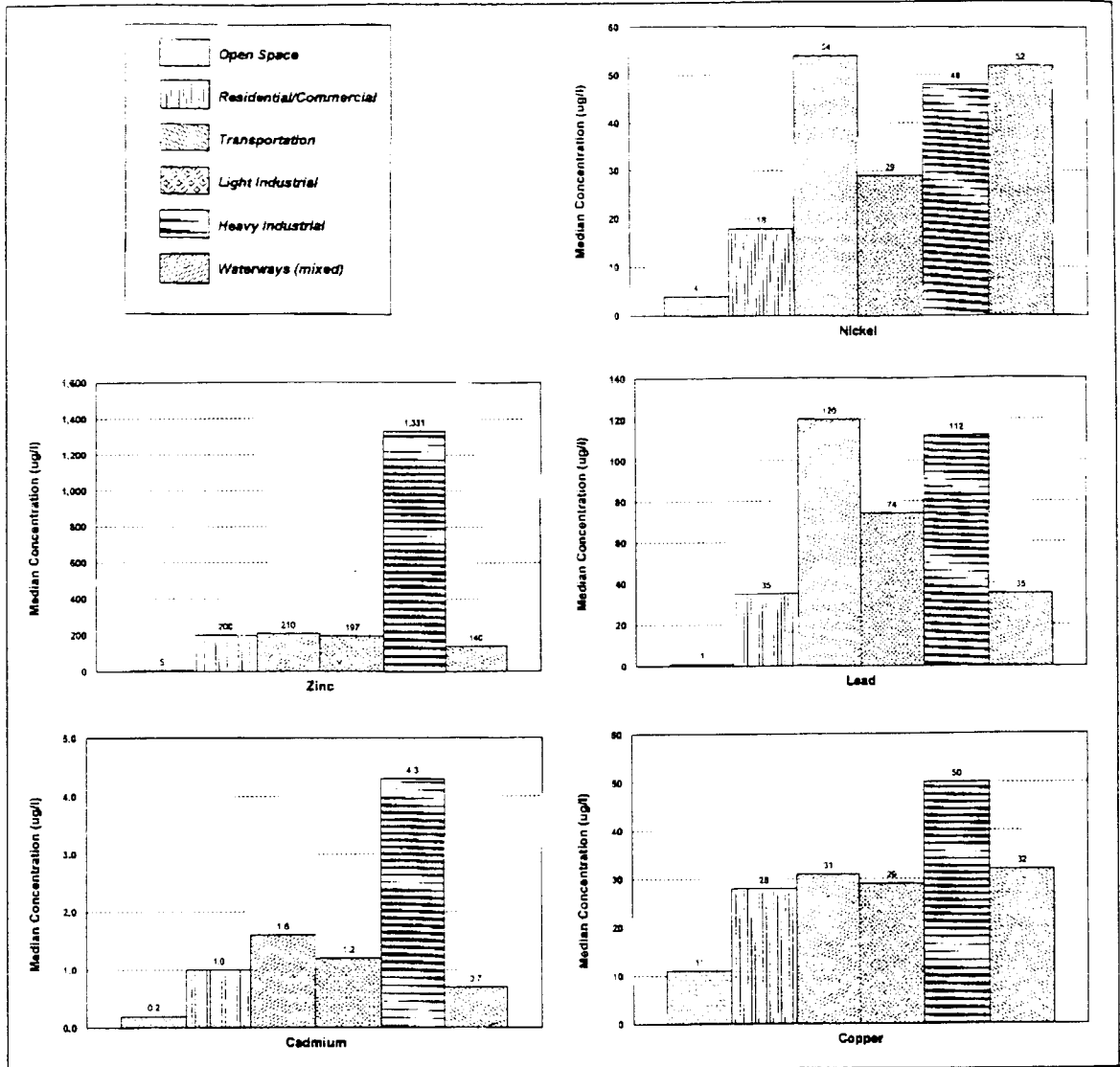

Figure 2: Median Metal Concentration in Stormwater Runoff in Santa Clara Valley, 1987-1989 (Cooke et al., 1995)

tions were significantly lower in 1992 as compared to 1990 and 1991. The ANCOVA analysis, which used station and years as the effects to be tested, indicates that the observed differences are probably attributable to rainfall. Rainfall was significantly higher in 1992 than in the other two years.

Stormwater data from waterways stations (which are used to evaluate compliance) were analyzed to determine the duration, frequency, and severity of water quality objectives (WQOs) violations. Four years of data were compared to water quality objectives listed in the California Inland Surface Waters Plan (April 1991). Acknowledging the relatively short, pulse-like loading associated with stormwater pollutants, the storm data were compared to one-hour and four-day freshwater criteria. (The average storm duration in the Santa Clara Valley is 36 hours.) The one-hour ("acute") objec-

tive was indicative of potential toxicity problems. The four-day objective was used to observe "chronic" conditions.

Dissolved metal concentration did not exceed the acute, one-hour limit. Furthermore, less than 5% of the samples exceeded the lower, four-day, chronic limit. Although this finding suggests that metal toxicity was not a problem, other more traditional toxic tests indicated otherwise. The traditional toxicity tests were performed to characterize toxicity with respect to land use and to provide a basis for assessing long-term toxicity frequency and intensity at the waterways stations. Chronic, seven-day toxicity tests using *Ceriodaphnia dubia* and toxicity identification evaluations (TIE) protocols were used.

The toxicity tests suggest that stormwater runoff from heavy industrial, commercial, and residential land



uses in the Santa Clara Valley impairs aquatic health. All of the samples from the heavy industrial station were extremely toxic (i.e., 50% of the test organisms died within 24 hours). The residential/commercial station samples were extremely to moderately toxic (50% mortality within four to seven days). In comparison, less than one-quarter of the transportation station samples were extremely or moderately toxic.

The causes of the observed toxicity were investigated using TIEs. The TIE results suggest that dissolved metals account for the extremely toxic conditions at the heavy industrial station. Additional TIE results indicate that non-polar organics such as pesticides and hydrocarbons are the most significant causes of toxicity in the mixed land use, waterways stations.

It should be noted that because non-native organisms and a laboratory testing environment were used in the toxicity tests, the test results may not accurately represent stormwater impacts on aquatic health. In-situ testing with native species has been proposed as a more accurate assessment methodology.

The watershed monitoring effort represents a tremendous expenditure of time, manpower, and finances. A power analysis was conducted to examine if the watershed monitoring effort could be reduced while providing sufficient data to detect potential long-term trends in water quality. The ability to detect statistically significant long-term trends is influenced by the magnitude of the difference to be observed, the data availability, the number of observations, and the targeted confidence level. In general, the probability of detecting a long-term trend decreases with data variability and increases with the number of observations.

The power analysis focused on the number of observations and stations analyzed. If all four waterway stations are included in the monitoring effort, an average of seven storms per year at each station would be required to confirm a 40% change in heavy metal concentrations over a 10-year period at the 80% confidence level (see Figure 3). Assuming that it is possible to achieve a 40% reduction in total metals concentrations in one decade, it is unlikely that the resources needed to collect the required stormwater data will remain available.

Continued dependence upon traditional water quality monitoring and toxicity testing should be reconsidered. Although the Program collected data from 200 station-events, no unexpected trends were revealed. The spatial and temporal trends detected using the traditional monitoring approach were not unanticipated: higher pollutant levels are generally associated with urbanized areas, runoff from industrial and transportation land uses usually contain elevated heavy metal levels, and metal concentrations are generally lower during rainy years.

An alternative indicator monitoring program could provide the data required to assess the efficacy of the

watershed program control efforts. The toxicity test results suggest that aquatic health is endangered. Incorporation of biological monitoring based on native species and in-situ testing would confirm (or negate) the toxicity result. In addition, trends in fish and/or macro-invertebrate health and abundance can be extrapolated to assess overall aquatic health.

At this time, the Program plans to continue traditional stormwater monitoring in the two major watersheds. Five storms per year will be monitored to evaluate long-term trends and to assess compliance with WQOs and toxicity objectives. The two smaller sub-watersheds will be monitored every other year to provide comparative data and to assess compliance. Special stations will also be used to evaluate the effectiveness of pollution control measures.

Although the Program has placed greater emphasis on expansion of the stormwater monitoring program as part of the overall management effort, public education and participation have also been incorporated into the monitoring effort. One such example is their support of citizen efforts such as the Coyote Creek Riparian Station (CCRS). CCRS sponsors a volunteer biological monitoring effort, Community Creek Watch. This effort, which focuses on birds, amphibians, and reptiles, provides data on riparian habitat and, to a lesser extent, water quality in the streams. See also article 16. —TRS

#### References

- Cooke, T., D. Drury, R. Katznelson, C. Lee, P. Mangarella, K. Whitman. 1995. "Storm Water NPDES Monitoring in Santa Clara Valley." *Proceed From Stormwater NPDES Related Monitoring Needs*. Crested Butte, CO. Aug. 7-12, 1994.

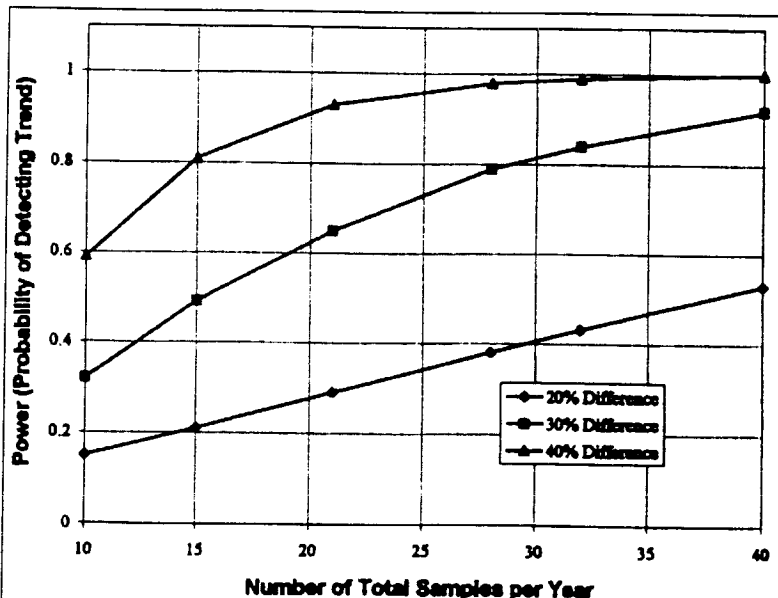

Figure 3: Samples Needed to Detect a 10-year Trend in Total Copper Based on ANCOVA Using TSS (Cooke et al., 1995)

# Simple and Complex Stormwater Pollutant Load Models Compared

**E**stimates of stormwater pollutant loadings are important to watershed managers as they grapple with costly decisions on nonpoint source control. Often, a knowledge of comparative pollutant loadings helps managers target resources to priority subwatersheds or predict the water quality response of a stream, lake, or estuary to urbanization. When choosing models to compute stormwater pollutant loads, managers seek a blend of accuracy, reliability, and timeliness, while minimizing the cost of obtaining such information. Stormwater pollutant loading models vary widely in their cost, effort, and accuracy depending on the complexity of model used, its data requirements, drainage area resolution, and need for model calibration and verification.

Stormwater pollutant load models allow managers to quantitatively assess water quality impacts from development and benefits of stormwater treatment practices. Although often used to refer specifically to computerized models, the term "model" in this article encompasses the entire range of stormwater pollutant load estimate computation techniques. Stormwater pollutant load models can range from the simple to complex, encompassing "back-of-the-envelope" methods to full-blown, multi-year computerized models (see Table 1).

Given the variety and number of models available, the key question is which model provides the required management information with the best blend of accuracy and speed.

A common simple model, the Simple Method (Schueler, 1987; Table 2), estimates stormwater pollutant loads as the product of mean pollutant concentrations and runoff depths over specified periods of time (usually annual or seasonal). Two well-known examples of computerized models include EPA's Stormwater Management Model (SWMM) and the Hydrologic Simulation Programming-FORTRAN (HSPF) model. These models simulate representative hydrologic and hydraulic conditions in the watershed, subwatershed, and stream system and estimate stormwater pollutant loads through consideration of a variety of factors including soil type, infiltration, and exponential washoff (Table 2). In general, the Simple Method is most appropriate for small watersheds (<640 acres) and when quick and reasonable stormwater pollutant load estimates are required (Table 3). Computer models, which are usually more time and funding intensive, are generally better

suited for analysis of larger and more complex watersheds and management scenarios.

Chandler (1994) reviewed case studies that used either SWMM or HSPF to estimate annual urban stormwater runoff volumes and pollutant loads (Table 4). Computer model runoff and pollutant load estimates were then compared to estimates made using the Simple Method. Chandler focused on four case studies: Santa Clara Valley in California and Lake Union/Ship Canal, Covington, and Scriber Creek in Washington State. In total, 124 comparisons were made, with 96 of those comparisons occurring as part of the Santa Clara Valley case study (Table 4).

The Simple Method and computer model results were compared by computing a "maximum ratio" for various parameters. The maximum ratio represents the largest ratio between the simple and complex model pollutant load and runoff volume estimates. The maximum ratio is always greater than or equal to one; the larger of the two estimates being compared (i.e., the Simple Method or the computer model estimate) is always in the numerator. Positive values indicate that the computer model estimate was larger than the corresponding Simple Method estimate. Negative values indicate that the Simple Method estimate was larger than the computer model estimate. For example, in a given scenario the annual runoff volume estimate gen-

**Table 1: Stormwater Pollutant Model Types (From Least to Most Complex) (Horner, 1994)**

- Models based on established literature ranges of unit area pollutant loading factors
- Models based on simple empirical relationships such as the Simple Method (Schueler, 1987)
- Models using regression equations (Driver and Tasker, 1990)
- Models incorporating site-specific or modeled flow data and either local or published concentrations
- Continuous simulation models, such as the Storage, Treatment, Overflow, and Runoff Model (STORM); Storm Water Management Model (SWMM); and Hydrologic Simulation Program-Fortran (HSPF)

**Table 2: Summary of the Simple Method (Schueler, 1987) and Factors Used in Complex Models (e.g., SWMM and HSPF) to Estimate Pollutant Loads (Chandler, 1993 and 1994)**

**Simple Method**

1. Calculation of the runoff coefficient,  $R_v$   
 $R_v = 0.05 + 0.009(I)$
2. Calculation of runoff depth (acre-feet per time interval)  
 $R = [(P)(P_j)(R_v)/12](A)$
3. Calculation of annual pollutant loads (pounds/aces per time interval)  
 $L = \frac{(R)(C)(2.72)}{A}$  or  $L = [(P)(P_j)(R_v)/12](C)(2.72)$

where:

- $R_v$  = Mean runoff coefficient, expressing the fraction of rainfall converted into runoff
- $I$  = Percent of site imperviousness
- $R$  = Runoff (acre-feet per time interval)
- $P$  = Rainfall depth over desired time interval (inches)
- $P_j$  = Fraction of rainfall events that produce runoff (0.9 in the Washington, DC region)
- $A$  = Area of the site (acres)
- $L$  = Urban runoff load (pounds/acres per time interval)
- $C$  = Flow-weighted mean concentration of the pollutant in urban runoff (mg/L or ppm)
- 12 = Conversion factor (inches/foot)
- 2.72 = Conversion factor (pounds/acre-foot-ppm)

**Complex Models: Considered Factors**

- Rainfall
- Infiltration rates
- Evaporation rates
- Overland flow
- Depression storage
- Imperviousness
- Channel roughness
- Solar intensity
- Pollutant accumulation
- Exponential washoff of pollutants
- Interflow
- Streamflow
- Snowmelt
- Slope
- Temperature
- Soil type

erated by SWMM is 83,000 acre-ft and the Simple Method estimate is 68,000 acre-ft. The maximum ratio value (the larger computer model estimate/the smaller Simple Method estimate) is approximately 1.22. Since the computer model estimate is the higher value, the ratio is positive.

Chandler computed a total of 124 maximum ratios for runoff volume and select nutrient, chemical, and heavy metal constituents (Table 5). Seventy percent of the maximum ratio values ranged from one to two, indicating that, in general, the computer model and Simple Method results were comparable (Figure 1). Total Kjeldhal nitrogen (TKN), nitrate, and BOD estimates were the most similar, ranging from positive 1.11 to negative 1.19.

Significant discrepancies, however, were noted between the Simple Method and computer model estimates for phosphorus and heavy metals, particularly lead (Table 5). This may be partly attributed to the fact that the Simple Method, unlike the computer models, does not take into account background or erosional sources of pollutants.

The use of national average "C" values could also be a source of disagreement between model results. "C" values are the flow-weighted mean concentrations of pollutants in urban stormwater runoff (mg/L or ppm). Nationwide Urban Runoff Program (NURP) data (U.S. EPA, 1983) is often used to develop "C" values used in computer models ("C" values were used in the Santa Clara Valley study). The NURP data, however, may not adequately account for regional and seasonal variations in pollutant concentrations. Furthermore, reductions in stormwater pollutant concentrations attributable to pollutant reduction measures implemented since the NURP study was conducted are not taken into account. For example, concentrations of lead in stormwater runoff have consistently declined over the past 20 years as a result of decreased use of leaded gasoline.

In other cases, the use of significantly different pollutant concentrations may explain differences between Simple Method and computer model results. In the Lake Union case study, Chandler applied the Simple Method and used a cadmium "C" value of 0.0014 mg/L,

**R0079512**

**Table 3: Conditions Making Simple and Complex Models (i.e., SWMM and HSPF) Appropriate for Estimating Urban Stormwater Pollutant Loads (Schueler, 1987; Chandler, 1993 and 1994)**

	When to Use	When Not to Use
<b>Simple</b>	<ul style="list-style-type: none"> <li>• small urban watersheds (&lt;640 acres)</li> <li>• only stormwater runoff and pollutant load estimates are desired</li> <li>• need for quick and reasonable load estimates</li> <li>• only percent imperviousness and runoff pollutant concentrations are available</li> <li>• Only planning level estimates are needed</li> </ul>	<ul style="list-style-type: none"> <li>• baseflow runoff/pollutant loads are desired</li> <li>• large watersheds (&gt;640 acres)</li> <li>• non-urban land uses (e.g., construction sites, industrial areas, rural development, agricultural uses), as reliable "C" values are unavailable</li> <li>• ambiguity about watershed's percent imperviousness</li> </ul>
<b>Complex</b>	<ul style="list-style-type: none"> <li>• large and complex watersheds</li> <li>• desire for:               <ul style="list-style-type: none"> <li>- a time history of runoff flow rate and pollutant concentrations</li> <li>- defining channel segments, bridges, culverts, etc., subject to erosion</li> <li>- determining maximum water elevations (for identifying floodplains)</li> <li>- provide hourly or daily load inputs to lake, river, or estuary water quality model</li> </ul> </li> </ul>	<ul style="list-style-type: none"> <li>• limited by time</li> <li>• limited by funds</li> <li>• high accuracy needed for dissolved pollutant parameters</li> <li>• uncertain whether complex model can provide more accurate information than simple model</li> </ul>

**Table 4: Qualitative Summaries of Four Case Studies Reviewed by Chandler (1993, 1994)**

	1 Santa Clara Valley	2 Lake Union & Ship Canal	3 Covington	4 Scriber Creek Watershed
<b>Complex model</b>	SWMM	SWMM	HSPF	HSPF
<b>Location</b>	CA	WA	WA	WA
<b>Study area (acres)</b>	441,600	2,605	1,238	4,389
<b>Avg. annual rain (in)</b>	13.2	39.77	36	36
<b>Avg. imperv.</b>	—	60%	26.7%	36%

synthesized from nine separate stormwater runoff studies. SWMM modelers, on the other hand, used a value of 0.05 mg/L, the average of three wide-ranging field samples. Consequently, the SWMM cadmium load estimate was much higher than the Simple Method

estimate (see Table 5). Thus, the selection of significantly different pollutant concentrations and/or limited data can generate significantly different results.

Chandler's study suggests that the Simple Method, with some refinements of the "C" values for current,

**Table 5: Maximum Ratios for Runoff and Pollutants in Four Case Studies Comparing Simple and Complex Models, as Derived From Annual Load Estimates (Chandler, 1994)**

Parameter (loads in pounds)	Santa Clara	Lake Union	Covington	Scriber Creek	
				Current Land Use	Future Land Use
Runoff (acre-ft)	1.22	-1.04	1.93	-	-
TP	2.06	-3.57	-2.08	-1.47	-1.39
TKN	-1.01	1.11	-	-	-
NO <sub>3</sub>	-1.19	-	-	-	-
BOD	-1.04	-	-	-	-
Copper	1.72	1.87	1.84	-	-
Zinc	1.30	1.57	-1.95	-	-
Lead	-2.35	1.75	1.05	2.45	2.62
TSS	1.92	1.32	1.16	1.51	1.56
Chromium	-	2.07	-1.38	-	-
Cadmium	-	7.00	-	-	-

local conditions and recognition of method's limitations, is a useful tool that can provide reasonable water quality and pollutant load estimates quickly and cheaply. On the other hand, the use of complex computer models is justified, indeed necessary, when more complicated issues (e.g. urban pollution versus erosional or natural background sources, TMDLs, load allocation, etc.) are of interest. The key to choosing the appropriate model lies with determining beforehand the drainage area scale, availability of water quality and hydrologic data, and availability of resources and personnel. When the appropriate model is selected, it can provide watershed managers with important guidance for targeting areas in need of protection and for predicting the magnitude and risks associated with pollutant loads.

-RLO

**References**

Chandler, R.D. 1993. *Modeling and Nonpoint Source Pollution Loading Estimates in Surface Water Management*. MS Thesis, Univ. of Washington, Seattle.

Chandler, R.D. 1994. "Estimating Annual Urban Nonpoint Pollutant Loads." *Journal of Management in Engineering* 10(6): 50-59.

Driver, N.E. and G.D. Tasker. 1990. *Techniques for Estimation of Storm-Runoff Loads, Volumes, and Selected Constituent Concentrations in Urban Watersheds in the United States*. Water Supply Paper 2363. USGS, Reston, VA.

Horner, R.R. et al. 1994. "Water Quality Impacts of Urban Land Use." In *Fundamentals of Urban Runoff Management: Technical and Institutional Issues*. Terrene Institute, Washington, DC.

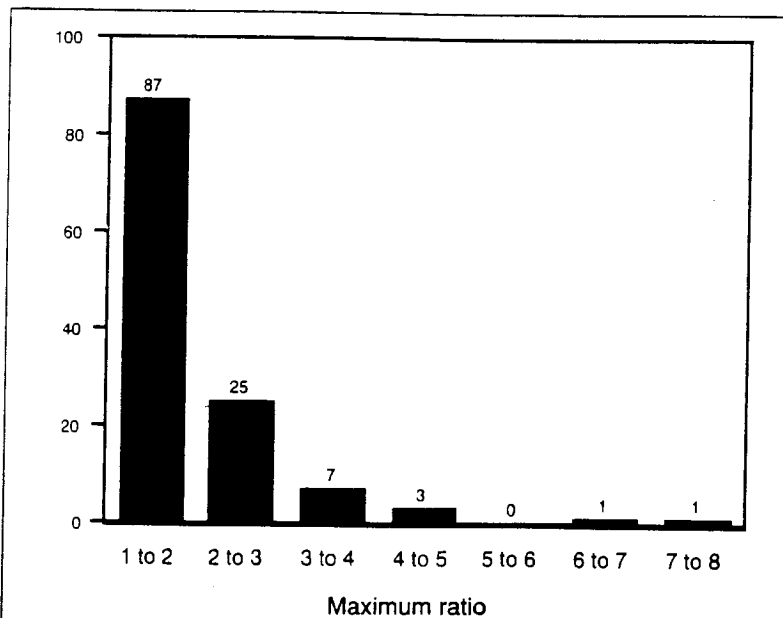

**Figure 1: Ratio of Load Difference Computed by Simple Method Compared to SWMM or HSPF (124 annual comparisons) (Chandler, 1993 and 1994)**

Schueler, T.R. 1987. *Controlling Urban Runoff: A Practical Manual for Planning and Designing Urban BMPs*. Publ. No. 87703. Metropolitan Washington Council of Governments, Washington, DC.

U.S. EPA. 1983. *Results of the Nationwide Urban Runoff Program*. Vol. 1-Final Report. Water Planning Division. NTIS PB84-18552. Washington, DC.

**R0079514**

# Impact of Suspended and Deposited Sediment

**T**here is little doubt that construction sites rank among the most significant sources of sediment today. For example, Goldman (1986) computed that construction sites are responsible for an estimated export of 80 million tons of sediment into receiving waters each year. On a unit area basis, construction sites export sediment at 20 to 2,000 times the rate of other land uses. While the muddy waters that run off from construction sites are easy to observe, many watershed managers are not fully aware of the many downstream impacts eroded sediments have on both the environment and the economy. Given the cost and effort needed for ESC control, it is important to remember why it matters.

The effects of sediment on biota, recreation and the economy are both subtle and profound, and they can be gleaned from several recent literature syntheses. The nature of the sediment impacts depend on whether sediments are suspended in the water column (Table 1) or are deposited on a stream channel or lake bottom (Table 2). Taken together, the 30 reported impacts confirm that eroded sediment is a major pollutant in waterways.

Much of the research on the impacts of sediment on aquatic systems is rather dated. However, two more recent biological surveys indicate that eroded sedi-

ment can have a dramatic influence on aquatic biota. For example, while often overlooked, freshwater mussels are a major component of the ecology of streams and rivers. Mussels filter out plankton from running waters, and in turn, serve as a key food source for fish, wading birds, and other vertebrates. A recent review of the status of native mussels in North America strongly suggests that this important freshwater resource is imperiled. In fact, of 297 native species reviewed by Williams *et al.* (1993), 72% are either endangered, threatened or of special concern. Only 24% of all native species are considered to be stable.

The sharp decline in biological diversity noted for native mussels is primarily a result of habitat alteration (by dams, channelization, and invasion by non-native species). Of particular concern is the effect of deposited sediments on mussel habitat. Siltation and the subsequent shifting and smothering of the stream or river bottom are cited as major factors in the decline of mussel biota. Clearly, native freshwater mussels are particularly vulnerable to increased watershed erosion and sediment deposition, and may be at risk if upstream construction sites are poorly managed.

Recent research has also revealed that rare and threatened fish species are vulnerable to even relatively small increases in stream turbidity. For example, Kundell

**Table 1: Summary of the Impacts of Suspended Sediment on the Aquatic Environment**

- Abrades and damages fish gills, increasing risk of infection and disease
- Scouring of periphyton from stream (plants attached to rocks)
- Loss of sensitive or threatened fish species when turbidity exceeds 25 NTU
- Shifts in fish community toward more sediment tolerant species
- Decline in sunfish, bass, chub and catfish when monthly turbidity exceeds 100 NTU
- Reduces sight distance for trout, with reduction in feeding efficiency
- Reduces light penetration causing reduction in plankton and aquatic plant growth
- Reduces filtering efficiency of zooplankton in lakes and estuaries
- Adversely impacts aquatic insects which are the base of the food chain
- Slightly increases stream temperature in summer
- Suspended sediments are a major carrier of nutrients and metals
- Turbidity increases probability of boating, swimming and diving accidents
- Increased water treatment costs to meet drinking water standards of 5 NTU
- Increased wear and tear on hydroelectric and water intake equipment
- Reduces anglers chances of catching fish
- Diminishes direct and indirect recreational experience of receiving waters



and Rasmussen (1995) recently reported on the sensitivity of six state or federally listed endangered fish species in Georgia rivers that were adversely impacted when turbidity exceeded 10 to 25 nephelometric turbidity units (NTUs). The fish species included blue shiners, freckle-belly madtom, river darter, amber darter, log perch and freckled darter. Three-quarters of these species were eliminated when turbidity occasionally exceeded 25 NTU on a monthly basis; all were lost when turbidity more frequently exceeded 25 NTU.

Construction site erosion is but the first pulse in sediment load associated with urban development. A second, and possibly greater sediment pulse, occurs as stream banks begin to erode in response to the greater volume and frequency of stormwater flows generated by impervious cover. More research is needed to define the impacts of suspended and deposited sediments during both pulses occurring in developing watersheds.

—TRS

#### References

- Goldman, S., et al. 1986. *Erosion and Sediment Control Handbook*. McGraw-Hill. New York. 443 pp.
- Kundell, J., and T. Rasmussen. 1995. "Recommendations of the Georgia Board of Regents Scientific Panel on Evaluating the Erosion Measurement Standard Defined by the Georgia Erosion and Sedimentation Act." pp. 211-217. In: *Proceedings 1995 Georgia Water Resources Conference*. University of Georgia, Athens, GA.
- Williams, J., M. Warren, K. Cummings, J. Harris, and R. Neves. 1993. "Conservation Status of Freshwater Mussels of the United States and Canada." *Fisheries* 18(9): 6-22.

**Table 2: Summary of the Impact of Deposited Sediments on the Aquatic Environment**

- Physical smothering of benthic aquatic insect community
- Reduced survival rates for fish eggs
- Destruction of fish spawning areas and redds
- "Imbedding" of stream bottom reduces fish and macroinvertebrate habitat value
- Loss of trout habitat when fine sediments are deposited in spawning or riffle-runs
- Sensitive or threatened darters and dace may be eliminated from fish community
- Increase in sediment oxygen demand can deplete DO in lakes or streams
- Significant contributing factor in the alarming decline of freshwater mussels
- Reduced channel capacity, exacerbating downstream bank erosion and flooding
- Reduced flood transport capacity under bridges and through culverts
- Loss of storage and lower design life for reservoirs, impoundments and ponds
- Dredging costs to maintain navigable channels and reservoir capacity
- Spoiling of sand beaches
- Deposits diminish the scenic and recreational value of waterways

R0079516

# Stormwater Pollution Source Areas Isolated in Marquette, Michigan

**M**uch of our knowledge about the source of stormwater pollutants in urban watersheds is confined to broad land use categories, such as residential, commercial, or industrial. Often, engineers need much more detailed information on the individual source areas of pollutants to design more effective stormwater management practices or to craft better pollution prevention plans. For example, residential land use is actually a mosaic of streets, driveways, rooftops and lawns. Each of these individual source areas can contribute vastly different runoff volumes or pollutant concentrations. Consequently, engineers are interested in discovering precisely which source areas in the urban landscape contribute the bulk of the pollutant loads measured at the end of the stormwater pipe, particularly for those pollutants that are potentially toxic.

Urban source area monitoring methods were first pioneered by Roger Bannerman and his colleagues at the Wisconsin Department of Natural Resources (DNR) (see article 7). They typically involve the installation of very small and specialized sampling devices that collect stormwater runoff from a few thousand square feet of each source area. Several hundred samples are collected, and then geometric mean concentrations are computed. The first major source area monitoring study was conducted in a subwatershed located in Madison, Wisconsin (Bannerman *et al.*, 1993).

A second major source area monitoring study was recently completed in Marquette, Michigan by Jeff Steuer and his colleagues (1997). They investigated a 289 acre subwatershed that drains to Lake Superior. The subwatershed is primarily residential with most of the development built 50 to 100 years ago (Table 1). Although the subwatershed had 37% impervious cover, its sandy soils generated relatively little surface runoff (runoff coefficient of 0.14 during the course of the study).

Steuer and his team deployed 34 different source area monitoring devices in the subwatershed and collected more than 550 source samples during 12 storm events. The source area monitoring was performed during the growing season (i.e., snowmelt and winter runoff were not sampled). Eight key source areas were targeted in the sampling effort: commercial parking lots; low, medium and high traffic streets; commercial and

**Table 1: A Profile of the Marquette, a Michigan Subwatershed**

Drainage Area	289 acres
Land Use	
Residential	55 %
Open Space	29 %
Commercial	9 %
Institutional	7 %
Pervious Area	63 %
Impervious Area	37 %
Soil Type	Sandy, HSG "A"
Runoff Coefficient	0.14
Age of Development	50 to 100 years
Average Annual Precipitation	31.9 inches
Total Rainfall During Source Sampling	13.2 inches

residential rooftops; residential driveways and lawns. More than 40 different pollutants were measured in the study, including sediment, nutrients, total and dissolved metals and a wide range of polycyclic aromatic hydrocarbons (PAHs). The study team also sampled pollutant levels at the bottom of the entire subwatershed. This enabled them to calibrate the Source Load and Management Model (SLAMM). The SLAMM model simulates subwatershed hydrology and source area pollutant concentrations to relate how pollutant loads from individual source areas compared to the subwatershed as a whole (Pitt and Voorhees, 1989).

The SLAMM model did an excellent job of predicting pollutant loads from the subwatershed. Typically, the pollutant load computed from component source areas was within 90 to 110% of the total subwatershed pollutant load measured over the 12 storm events.

**Source Areas: Runoff Production**

The load of a stormwater pollutant from any source area is a product of its pollutant concentration and its runoff volume. Thus, it is of considerable interest to discover how much runoff volume a particular source



area actually generates. The team employed the SLAMM model to assess the relative runoff contribution from the eight primary source areas within the Marquette subwatershed (Table 2). The "effective runoff coefficient" was dramatically different for many source areas, ranging from 0.01 to 0.58. As might be expected, the sandy soils of the residential lawns had the lowest runoff coefficient observed during the monitoring study. Despite the fact that lawns comprised more than 60% of subwatershed area, they generated only 6% of subwatershed runoff. The highest runoff coefficient was recorded for commercial parking lots, followed by streets. In contrast, residential rooftops and driveways had relatively low runoff coefficients, suggesting that these source areas were only partially connected to the storm drain system.

#### Nutrients and Oxygen Demand

One of the clear trends in the Marquette source area monitoring was that pervious areas had higher nutrient concentrations than impervious ones (Table 3). In particular, nitrogen and phosphorus concentrations in residential lawn runoff were five to 10 times higher than any other source area. Rooftop runoff, on the other hand, had the lowest nutrient concentration of any source area, which is not surprising given that atmospheric deposition is probably the only pollutant pathway. The study also confirmed the strong relationship between greater street traffic and higher nutrient and organic matter concentrations first observed by Bannerman *et al.* (1983). The Marquette team found that nutrient and organic matter concentrations in runoff from high traffic streets were two to three times higher than runoff from low traffic streets.

**Table 2: Relative Runoff Contribution From Different Source Areas During 12 Storm Events**

Source area sampled	Percent of total area	Percent of runoff	Effective runoff coefficient
Commercial Parking Lot	4.6	19.1	0.58
High Traffic Street	1.4	4.5	0.45
Med. Traffic Street	1.8	5.5	0.43
Low Traffic Street	8.9	26.9	0.42
Commercial Rooftop	3.5	10.2	0.41
Residential Driveway	4.2	9.8	0.32
Residential Rooftops	9.8	12.8	0.18
Residential Lawns	62.4	5.8	0.01
Sidewalks	3.0	ns	ns
Basin Outlet	100.0	95.0	0.14

\* Effective runoff is defined as the relative contribution of the source area to the total runoff volume produced in the basin over the 12 storm events.  
ns = not sampled

#### Hydrocarbons and Metals

The Marquette study also provided our first glimpse about hydrocarbon source areas in the urban landscape (Table 4). One might suspect that source areas dominated by vehicles would have the highest hydrocarbon levels, and this indeed was found to be the case. The highest PAH levels were recorded at the commercial parking lots (75 µg/l) and the high traffic streets (15 µg/l). In contrast, PAH levels at rooftops, driveways and low traffic streets were generally less than 2 µg/l. The team also monitored individual hydrocarbon compounds that comprise PAHs, some of which are known or suspected carcinogens, such as Pyrene. In general, the

**Table 3: Geometric Means of Conventional Pollutants at Marquette Source Areas (mg/l)**

Source area sampled	Total phosphorus	Total nitrogen	Total Kjeldahl nitrogen	BOD <sub>5</sub>
Commercial Parking Lot	0.20	1.94	1.6	10.5
High Traffic Street	0.31	2.95	2.5	14.9
Med. Traffic Street	0.23	1.62	1.3	11.6
Low Traffic Street	0.14	1.17	0.9	5.8
Commercial Rooftop	0.09	2.09	1.6	17.5
Residential Rooftop	0.06	1.46	1.0	9.0
Residential Driveway	0.35	2.10	1.8	13.0
Residential Lawns	2.33	9.70	9.3	22.6
Basin Outlet	0.29	1.87	1.5	15.4

R0079518

**Table 4: Source Area Concentrations of Hydrocarbons and Soluble Metals ( $\mu\text{g/l}$ )**

Source area sampled	Polycyclic aromatic hydrocarbons	Pyrene	Soluble zinc	Soluble Copper
Commercial Parking Lot	75.6	12.2	64	10.7
High Traffic Street	15.2	2.37	73	11.2
Med. Traffic Street	11.4	1.75	44	7.3
Low Traffic Street	1.72	0.27	24	7.5
Commercial Rooftop	2.1	0.33	263	17.8
Residential Rooftop	0.6	0.10	188	6.6
Residential Driveway	1.8	0.34	27	11.8
Residential Lawns	na	na	na	na
Basin Outlet	21.0	3.36	23	7.0

Notes: Pyrene is one component of PAH's. All measured in units of micrograms/liter (= ppb)  
na = not analyzed at the source area

greatest concentrations of these compounds were also detected at commercial parking lots and high traffic roads.

The team also investigated source area concentrations of total and soluble metals. While no clear trends were observed in total metal levels among most source areas, sharp differences were frequently noted for soluble metals. This is significant as soluble metals are much more likely to exert a toxic effect on aquatic life. Interestingly, the key source areas for soluble zinc were rooftops. Commercial and residential rooftops typically had soluble zinc concentrations that were three to four times higher than other source areas, which is consistent with other research on rooftop runoff.

Moderate levels of soluble zinc were also associated with commercial parking lots and high traffic streets. Source areas for soluble copper, on the other hand, were distributed rather evenly across the subwatershed, with the highest concentrations recorded at commercial roofs and parking lots, high traffic streets, and residential driveways. A strong relationship between greater street traffic and higher hydrocarbon and metal concentrations was also found.

#### Contributions of Individual Source Areas to Subwatershed Pollutant Loads

Using the SLAMM model, the team was able to analyze which source areas contributed most of the stormwater pollutant loads for the subwatershed (Table 5). The team discovered that some source areas delivered a disproportionate share of the total load. Most notable were commercial parking lots, which produced 64% of the PAH load, 30% of the total zinc load and 22%

of the total copper load, despite the fact they comprised less than 5% of subwatershed area. Similarly, medium and high traffic streets each generated about six to 10% of the subwatershed PAH, zinc and copper load even though each source area comprised less than 2% of subwatershed area. Surprisingly, residential driveways produced from 14 to 18% of the total phosphorus, copper and zinc load, despite the fact that driveways comprised less than 5% of subwatershed area.

Although residential lawns comprised 62% of subwatershed area, they were not believed to contribute to total load of many pollutants, such as PAH and metals. Lawns were the greatest source of phosphorus in the subwatershed (26%), which reflected the fact that while the sandy soils produced very little runoff, lawn runoff still had a very high phosphorus concentration. It is worth noting that if the study site had less permeable soils, lawns probably would have emerged as an even more important source area for nutrients and organic matter.

#### Summary

The Marquette source area monitoring study generally reinforced the findings of an earlier source monitoring study conducted in Madison, Wisconsin (Bannerman *et al.*, 1993). While the pollutant concentrations for each source area were not always the same, the relative rank among the source areas was basically the same in each study. This finding supports the notion that stormwater managers should seriously consider pollutant source areas when designing stormwater management practices or devising pollution prevention plans.

**Table 5: Comparisons of Source Area Loadings for Selected Pollutants, as Computed by the SLAMM Model**

Source area sampled	% Watershed area	Percent of Total Subwatershed Load			
		Copper	PAH	Zinc	Total phosphorus
Commercial Parking Lot	4.6	22	64	30	8
High Traffic Street	1.4	6	7	10	2
Med. Traffic Street	1.8	8	6	8	5
Low Traffic Street	8.9	17	5	19	15
Commercial Rooftop	3.5	11	3	16	5
Residential Rooftop	9.8	5	1	15	3
Residential Driveway	4.2	18	3	18	14
Residential Lawns	62.4	ns	ns	ns	26
Basin Outlet	97	87	89	116	77

ns = not sampled, as early monitoring indicated non-detection

Of particular concern are parking lots, which emerged as the dominant pollutant source for commercial areas in both studies. Parking lots produced a disproportionately high load of hydrocarbons and metals compared to all other source areas. As such, watershed managers can justifiably classify many parking lots as stormwater "hotspots." It may make sense to treat the quality of parking lot runoff directly at the source, using filtering practices such as sand, compost and bioretention filters. In any event, designers should probably avoid infiltrating stormwater runoff from parking lots.

Watershed managers should also take note of the strong relationship between pollutant concentrations and higher traffic streets. Runoff from more heavily traveled roads may require greater treatment volumes to control this important source area. Infiltration of roadway runoff should also be avoided, unless effective and reliable pretreatment can be assured.

The Marquette study also provides strong support for focusing the message of residential pollution prevention programs. Lawns and driveways were both implicated as key source areas for nutrients, organic matter and bacteria. Clearly, homeowners have an important role to play in residential source control. Less lawn fertilizer, more pet cleanups, safer car washing and more frequent driveway sweeping could collectively reduce the importance of residential areas as a source of stormwater pollution. —TRS

#### References

- Bannerman, R., D. Owens, R. Dodd and N. Hornewer. 1993. "Sources of Pollutants in Wisconsin Stormwater." *Water Science Technology*. 28(3-5): 241-259.
- Pitt, R. and J. Voorhees. 1989. *Source Load and Management model (SLAMM)—An Urban Nonpoint Source Water Quality Management Model*. Wisconsin Dept. of Natural Resources. PUBL-WR-218-89.
- Steuer, J., W. Selbig, N. Hornewer and J. Prey. 1997. *Sources of Contamination in an Urban Basin in Marquette, Michigan and an Analysis of Concentrations, Loads, and Data Quality*. U.S.G.S. Water Resources Investigations Report 97-4242. Wisconsin DNR and EPA. 25 pp.

R0079520

## Diazinon Sources in Runoff From the San Francisco Bay Region

**D**iazinon is a common broad spectrum insecticide that is widely applied by homeowners and pest control professionals alike. In California alone, diazinon is contained in over 200 different pesticide formulations. The primary use for diazinon is for general insect control, with the most common targets being ants, fleas, ticks, grubs and spiders. It is often the insecticide of choice to deal with fire ant problems in the South.

There are several reasons why watershed managers are concerned about the use of diazinon. To begin with, diazinon is highly toxic to aquatic life at exceptionally low levels. Toxicologists have found that diazinon causes mortality in the popular bioassay organism, *Ceriodaphnia dubia* (water flea) at exposure levels as low as 300 parts per trillion. In addition, diazinon is very soluble and therefore very mobile in the urban environment. Although it eventually breaks down in the environment, diazinon has a half-life of about 40 days in surface waters. In addition, diazinon is typically sprayed as a concentrate on a spot basis near foundations, driveway cracks, sidewalk crevices and other impervious surfaces.

Given these factors, it is not surprising that researchers are frequently finding diazinon in stormwater and dry weather flows in urban streams, particularly in the South (Schueler, 1995). Diazinon has been detected in urban streams in Sacramento, CA (O'Connor, 1995), Atlanta, GA (Hippe *et al.*, 1994) and Dallas-Fort Worth, TX (Brush *et al.*, 1996). In each case, diazinon was detected in nearly 90% of all stream samples. In the Texas study, the mean runoff concentration of diazinon at 11 residential catchments was a whopping 1,800 ng/l (parts per trillion).

Until recently, our understanding of the sources and pathways of diazinon in urban watersheds has been very sparse. A much clearer picture, however, has recently emerged from a comprehensive research effort in the San Francisco Bay region. The study team included James Scanlin, Tom Mumley, Revita Katznelson, Val O'Connor and many other colleagues. The study team has progressively traced diazinon sources to increasingly smaller watershed units. The team investigated diazinon at the regional scale, and then proceeded to urban watersheds, and even smaller subwatersheds. From there, they continued to trace

diazinon through individual storm drain outfalls, to street gutters and finally, to individual homes. In addition, the team profiled how diazinon is actually used in residential areas, through surveys and retail sales statistics. Taken together, the story of their search is both interesting and very disturbing.

The story begins with how diazinon is actually used. Scanlin and Cooper (1997) started by checking statistics on retail sales of diazinon, which are required under California's extensive pesticide reporting system. For the California and the Bay region, Scanlin and Cooper estimated that 0.04 lbs. of active diazinon was applied outdoors per person each year in the San Francisco Bay area. As such, it was the leading insecticide used in California, in terms of retail sales of active ingredient. The primary reason cited for applying diazinon was general insect control (about 80%), with some additional use to control garden pests (20%). About half of the diazinon was applied to structures, and half applied to lawns and landscaped areas. Diazinon users were roughly split between homeowners and pest control companies. Users applied diazinon as a liquid concentrate about 65% of the time, and as granules about 34% of the time.

Concern about diazinon in the Bay area was initially prompted by a series of toxicity tests conducted by Steve Hansen and others in the early 1990s. Of 130 runoff samples from Bay area creeks, 22% caused mortality in *Ceriodaphnia dubia* within 48 hours, and further testing revealed that diazinon was the primary cause (Katznelson and Mumley, 1997). Consequently, a synoptic study was undertaken in 1995 to monitor diazinon, and 167 urban creek samples were collected around the Bay. Potentially toxic levels of diazinon were found in 27% of the storm samples (Table 1). The study concluded that diazinon was a widespread problem in many urban creeks, and also suspected that chlorpyrifos, another insecticide frequently found in creek runoff, might also be a problem.

The next chapter of the story involved extensive diazinon sampling across the San Francisco Bay region. New sampling methods made it easier to detect diazinon at both lower levels and lower cost. The study team compiled hundreds of samples and detected diazinon in rainwater, urban runoff, dry weather flow, creek sediments, wastewater effluent, and even the waters of San

Francisco Bay (Table 2). The highest levels were found in stormwater and dry weather flows in urban creeks. Rainfall was initially suspected as a major source of diazinon, since previous research had found rainwater concentrations as high as 4,000 ng/l. These very high levels, however, were collected in the highly agricultural Central Valley of California, and were apparently influenced by the drift of diazinon from orchard spraying. In the San Francisco Bay region, diazinon was detected in less than one half of rainfall samples, and no rainfall sample exceeded 100 ng/l.

Diazinon was also routinely detected in wastewater effluent, which was presumably due to indoor use and disposal. Treatment plants had great difficulty in removing this soluble insecticide, and it frequently caused the plants to flunk their effluent toxicity tests. Diazinon levels in the water column of San Francisco Bay were well below potential estuarine toxicity thresholds (30 ng/l chronic, 80 ng/l acute). It is worth noting that the highest concentrations in the Bay were almost always found near urban creeks.

Based on the regional monitoring data, the study team narrowed their focus to urban creeks, where the greatest potential for toxicity existed. The search for watershed sources of diazinon then began in earnest. Scanlin and Feng (1997) performed automated sampling of runoff and dry weather flow in Castro Valley Creek, a 5.5 square mile residential watershed in Alameda County. They sampled 22 storms over two years and detected diazinon in all events. The mean

**Table 1: Occurrence of Diazinon in San Francisco Creeks Spring 1995 Coordinated Survey (N=167) (Katznelson and Mumley, 1997)**

Diazinon Levels	Toxicity to <i>Ceriodaphnia</i>	Percent of storm samples
< 30 ng/l <sup>1</sup>	Not detectable	43
30 to 150 ng/l	Non-lethal	29
150 to 300 ng/l	Lethal 4 to 7 days	16
300 to 500 ng/l	Lethal within 96 hours	11

<sup>1</sup> ng/l = nanograms per liter (or parts per trillion)

storm concentration was 343 ng/l and ranged from 90 to 820 ng/l. As might be expected, higher diazinon levels were found during spring storms when application rates were greatest. Diazinon concentrations also tended to be greater if it had been dry for several weeks before the storm.

High concentrations persisted for several days after storms and often exceeded 200 ng/l. In general, diazinon levels dropped only 50% two days after a storm. Scanlin and Feng (1997) computed a mass balance for Castro Valley Creek and concluded that 90% of the diazinon load was delivered by stormwater runoff. They concluded the mass load discharged by the Creek could be

**Table 2: Summary of Diazinon Levels (ng/l) from Different Sources in the San Francisco Bay Region (Katznelson and Mumley, 1997)**

Diazinon source sampling	N	Mean	Maximum	Minimum
Rainfall <sup>1</sup>	8	58 <sup>3</sup>	88	33
Stormflow <sup>2</sup>	23	262	590	< 30
Dry weather flow	43	282 <sup>4</sup>	3,000	< 30
Creek sediments ( $\mu\text{g}/\text{kg}$ )	43	19	59	2.6
San Francisco Bay	55	10	98	< 0.1
Wastewater effluent <sup>5</sup>	21	78	809	< 30

<sup>1</sup> Mean of rainfall samples with detectable diazinon concentrations.

<sup>2</sup> Selected streamflow samples.

<sup>3</sup> Diazinon levels in rainfall from the Central Valley of California influenced by agricultural pesticide drift were about two orders of magnitude higher than the Bay area samples which were not influenced by agricultural spraying.

<sup>4</sup> If two extreme values are excluded, the mean dry weather concentration drops to 170 ng/l.

<sup>5</sup> Mean of effluent discharge from Bay area wastewater treatment plant, presumably reflects household disposal. Removal rates at treatment plants averaged only 35%.

R0079522

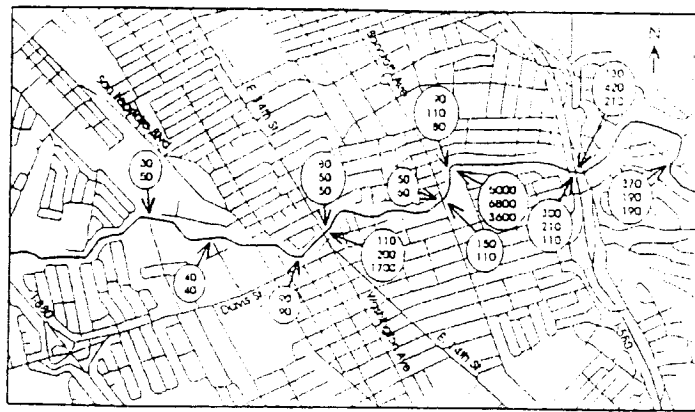

**Figure 1: Street Gutter Sampling of Diazinon in Castro Valley Creek (Scanlin and Feng, 1997)**

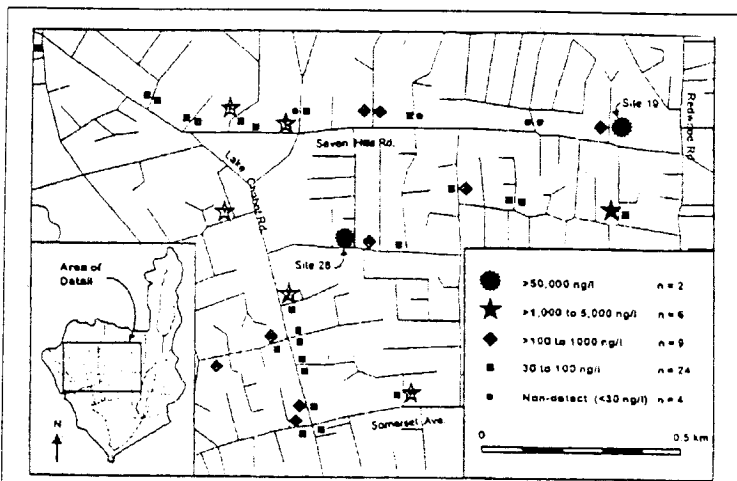

**Figure 2: Diazinon Levels in Small Drain Outfalls in San Leandro Creek, Spring, 1996 (Katznelson and Mumley, 1997)**

The search for diazinon continued on an even smaller scale. Scanlin and Feng moved up the catchments to sample individual street gutters. They collected samples at 45 randomly selected street gutters within two catchments of Castro Valley Creek during a single storm event in May of 1996. Each street gutter served about four of five homes. At last, they were able to find diazinon hotspots (Figure 1). The mean diazinon level climbed to 3,900 ng/l in all of the street gutter samples, but the range spanned three orders (30 to 70,000 ng/l). After a block-by-block search, they concluded that diazinon levels in Castro Valley Creek were produced at a very small number of individual residential hotspots. As few as two to 4% of residential homes in the watershed accounted for the bulk of diazinon observed in Castro Valley Creek. A similar pattern was also observed in monitoring of small storm drain outfalls to San Leandro Creek (Figure 2).

The final stage of monitoring evaluated diazinon runoff from individual homes. Two homes were selected for intensive source area sampling. Diazinon was applied to each home at recommended rates and in accordance with label instructions. Source area samples were collected from roof drains, patios and driveways following rainfall events for 50 days after application (Table 3). As might be expected, the highest diazinon concentrations were recorded when it rained a few days after initial application (1,100 to 1,200,000 ng/l). Nevertheless, high diazinon concentrations were still recorded in runoff three and even seven weeks after application. The largest source areas were patios and driveways, followed by roof drains.

**Implications**

The diazinon research has several profound and troubling implications. The first is that harmful diazinon levels can be produced in urban streams from a handful of individual homes within any given watershed. Once diazinon gets into urban streams, it is not easy to remove it. Because of its solubility, current stormwater and even wastewater treatment technology cannot significantly reduce diazinon levels. The only real tool to control diazinon in urban watersheds is source control—to either reduce the use of diazinon or to apply it in a safer manner. It should be noted that residential source areas monitoring indicated that “proper use” still produced very high diazinon levels, even when label directions were scrupulously followed.

Consequently, a strong case can be made that the use of diazinon should be restricted or banned in residential areas. Fortunately, for the first time since diazinon was initially registered in 1956, a unique opportunity is currently available to consider such actions. Every pesticide must be re-registered under 1988 federal pesticide regulations, and diazinon’s registration is being reviewed right now. Accordingly, formulations

accounted by approximately 0.3% of diazinon applied outdoors in the watershed. This finding suggests that it takes very little washoff of the applied diazinon to produce the observed instream concentrations.

Sampling continued at smaller catchment scales. Scanlin and Feng collected grab samples in five smaller catchments within Castro Valley Creek during a single storm event in April of 1996. The range of diazinon levels found in these catchments (mean 390 ng/l, range 201-675 ng/l) was nearly identical to that seen in Castro Valley Creek, despite the fact though each catchment differed greatly in pervious area, residential area, and open space. This suggested that diazinon loads could not be predicted on the basis of general land cover variables.

**Table 3: Concentrations of Source Area Runoff Samples Over Time From Single Family Homes Where Diazinon Was Applied According to Label Instructions (Katznelson and Mumley, 1997)**

	First week	Third week	Seventh week
No. of samples	5	6	12
Mean	281,600	166,500	19,200
Minimum	1,100	350	50
Maximum	1,200,000	880,000	110,000

and applications that cause runoff toxicity should be investigated and removed from USEPA's sanctioned list of registered diazinon uses.

In the meantime, watershed managers should send a strong message to homeowners that killing ants could very well harm streams, and encourage residents to practice integrated pest management (IPM) around their homes. The Urban Pesticide Committee is currently devising an outreach campaign to educate homeowners on safer ways to control insect pests in the Bay area that stresses IPM (Scanlin and Gosselin, 1997). Southern watershed managers may also wish to launch an aggressive homeowner IPM campaign, since diazinon use for fire ant control in these regions produces higher diazinon levels than the Bay area.

—TRS

#### References

- Brush, S., M. Jennings, J. Young and H. McCreath. 1995. "NPDES Monitoring—Dallas/Forth Worth Texas Area." pp. 115-143. In *Stormwater NPDES Monitoring Needs*. American Society of Civil Engineers.
- Hippe, D., D. Wangsness, E. Frick and J. Garret. 1994. *Pesticide Monitoring in the Apalachicola-Chattahoochee-Flint River Basin*. Water Resources Investigations Report No. 94-118. U.S. Geological Survey, National Water Quality Assessment Program, Atlanta, GA.
- Katznelson, R. and T. Mumley. 1997. *Diazinon in Surface Waters in the San Francisco Bay Area: Occurrence and Potential Impact*. Woodward Clyde Consultants and California Regional Water Quality Control Board. Oakland, CA. 64 pp.
- O'Connor, V. 1995. *Pesticide Toxicity in Urban Runoff. Technical Memorandum*. California Regional Water Control Board. Central Valley Region. Sacramento, CA. 30 January 1995.
- Scanlin, J. and A. Cooper. 1997. *Outdoor Use of Diazinon and Other Insecticides—Final Draft*. Alameda County Flood Control and Water Conservation District. Oakland, California. 20 pp.
- Scanlin, J. and A. Feng. 1997. *Characterization of the Presence and Sources of Diazinon in the Castro Valley Creek Watershed*. Alameda Countywide Clean Water Program and Alameda County Flood Control and Water Conservation District, Oakland, CA. 120 pp.
- Scanlin, J. and S. Gosselin. 1997. *Strategy to Reduce Diazinon Levels in Creeks of the San Francisco Bay Area*. Alameda County Flood Control and Water Conservation District. California State Water Resources Control Board. Oakland, CA. 32 pp.
- Schueler, T. 1995. "Urban Pesticides: From the Lawn to the Stream." *Watershed Protection Techniques* 2(1):247-253.

R0079524

# Microbes in Urban Watersheds: Concentrations, Sources, & Pathways

**M**icrobes are problematic. They are small and include hundreds of groups, species, biotypes and strains. They are ubiquitous in the environment, found on nearly every surface of the earth. They exist within us, on us, on plants, soils and in surface waters. They grow rapidly, die off, survive or multiply depending on a changing set of environmental conditions. Some microbes are beneficial to humans, while others exert no impact at all. Other microbes cause illness or disease, and a few can even kill you.

The presence of some types of microbes indicates a potential risk for water contamination, while other microbes are pathogens themselves (i.e., they are known to cause disease). Microbes are nearly always present in high concentrations in stormwater, but are notoriously variable. They are produced from a variety of watershed sources, such as sewer lines, septic systems, livestock, wildlife, waterfowl, pets, soils and plants, and even the urban stormdrain system itself.

It is little wonder that many watershed managers are thoroughly confused by the microbial world. This article seeks to provide enough background to help a watershed manager assess bacteria problems. It contains a national review and analysis of microbial concentrations, sources, and pathways in urban watersheds. The major focus is on fecal coliform bacteria, for which the most urban watershed data is available, but reference is also made to protozoa, such as *Cryptosporidium* and *Giardia*.

The article begins with a field guide to the bacteria found in urban waters. It compares the frequency of detection, origin, indicator status and measurement units of different microbes. The next section presents a national assessment of bacteria levels in urban stormwater. The last section profiles the many different human and nonhuman bacteria sources that can potentially occur in an urban watershed.

## Field Guide to the Microbes

The complex microbial world is confusing to most; therefore, it is worth a moment to understand some of the terminology used to describe it. The term *microbes* refers to a wide range of living organisms that are too small to see with the naked eye. *Bacteria* are very simple single celled organisms that can rapidly reproduce by binary fission. Of particular interest are *coliform*

*bacteria*, typically found within the digestive systems of warm-blooded animals. The coliform family of bacteria includes total coliforms, fecal coliforms and the group *Escherichia coli* (*E. coli*). Each of these can indicate the presence of fecal wastes in surface waters, and thus the possibility that other harmful bacteria, viruses and protozoa may be present. Fecal streptococci (a.k.a., *Enterococci*) are another bacteria group found in feces which, under the right conditions, can be used to determine if a waste is of human or nonhuman origin. As such, all coliform bacteria are only an *indicator* of a potential public health risk, and not an actual cause of disease.

A *pathogen* is a microbial species that is actually known to cause disease under the right conditions. Examples of bacterial pathogens frequently found in stormwater runoff include *Shigella spp.* (dysentery), *Salmonella spp.* (gastrointestinal illness) and *Pseudomonas aeruginosa* (swimmer's itch). Some subspecies can cause cholera, typhoid fever and "staph" infections. The actual risk of contracting a disease from a pathogen depends on a host of factors, such as the method of exposure or transmission, pathogen concentration, incubation period and the age and health status of the infected party.

*Protozoa* are single-celled organisms that are motile. Two protozoans that are common pathogens in surface waters are *Giardia* and *Cryptosporidium*. To infect new hosts, these protozoans create hard casings known as cysts (*Giardia*) or oocysts (*Cryptosporidium*) that are shed in feces, and travel through surface waters in search of a new host. The cysts or oocysts are very durable and can remain viable for many months. The protozoan emerges from its hard casing if and when a suitable host is found.

Table 1 provides a general comparison of the many microbes found in urban stormwater runoff, in terms of their frequency of detection, origin, indicator status, measurement units and information use.

Public health authorities have traditionally used fecal coliform bacteria to indicate potential microbial risk, and to set water quality standards for drinking water, shellfish consumption or water contact recreation. Some typical fecal coliform standards are provided in Table 2. Fecal coliforms are an imperfect indicator and regulators continually debate whether other bacterial species or groups are better indicators



**Table 1: Comparison of Microbes found in Urban Stormwater**

Microbial Indicator	Found in Urban Runoff?	Fecal Origin?	Non-Human Sources?	Indicator or Pathogen	Units of Measurement <sup>a</sup>	Information Use <sup>b</sup>
Total coliforms	All samples	Most	Animals, plants, soil	Neither	Counts per 100 ml	Historical, seldom used
Fecal coliforms	All samples	Most	Animals, plants, soil	Indicator	Counts per 100 ml	Water contact, shellfish, drinking water
Fecal streptococci	All samples	Yes	Warm-blooded animals	Indicator	Counts per 100 ml	Sometimes used to ID waste source <sup>c</sup>
<i>Escherichia coli</i>	Nearly all samples	Yes	Mammals, some found in soils	Indicator, some are pathogen	Counts per 100 ml	Water contact, shellfish, drinking water
<i>Salmonella spp.</i>	About half	Yes	Mammals (esp. dogs)	Pathogen	Counts per 10 ml	Food safety
<i>Pseudomonas aeruginosa</i>	All samples	Yes	Mammals	Pathogen	Counts per 100 ml	Drinking water
<i>Cryptosporidium spp.</i>	Less than half	Yes	Mammals (esp. livestock)	Pathogen	Oocysts per liter	Drinking water
<i>Giardia spp.</i>	Less than half	Yes	Mammals (esp. dogs and wildlife)	Pathogen	Cysts per liter	Drinking water

<sup>a</sup> Research use many different terms and sampling methods to describe their bacterial counts, including MPN (most probable number), colony forming units (CFU), colonies, or organisms.

<sup>b</sup> See Table 2 for a more thorough discussion on bacteria and protozoan standards.

<sup>c</sup> It is important to note that fecal strep is a poor method for urban stormwater

of potential health problems and how low indicator levels must be to ensure "safe" water. The debate, however, remains largely academic, as over 90% of the states still rely on fecal coliform in whole or in part as their recreational water quality standards (USEPA, 1998).

**Fecal Coliform Levels in Urban Stormwater Runoff**

Coliforms are ubiquitous — about 20% of all water quality samples at U.S. Geological Survey's main sampling stations across the country exceeded the 200 MPN/100 ml fecal coliform standard in the 1980s (Smith *et al.*, 1992) *Note: Most samples were conducted in dry weather conditions and in larger watersheds.* The highest fecal coliform levels were routinely collected in agricultural and urban watersheds. For-

ested and pastured watersheds had much lower fecal coliform levels (about 50 to 100 MPN per 100 ml).

The vast majority of urban stormwater monitoring efforts utilize fecal coliform as the primary microbial indicator. A small handful of researchers have measured other coliforms or other specific pathogens (e.g., *Salmonella*, *Pseudomonas*, etc.). Some caution should be exercised when evaluating storm concentrations of fecal coliforms, as most represent a "grab" sample rather than a true flow-composite sample. This, along with differences in how samples are counted and averaged, produces the notorious variability that is associated with stormwater fecal coliform data.

Pitt (1998) reports a mean fecal coliform concentration in stormwater runoff of about 20,000 colonies per 100 ml based on 1,600 storm runoff samples largely

**R0079526**

**Table 2: Typical Coliform Standards for Different Water Uses**

Water use	Microbial Indicator	Typical Water standards
Water contact recreation	Fecal coliform	<200 MPN per 100 ml
Shellfish bed	Fecal coliform	<14 MPN per 100 ml
Drinking water supply	Fecal coliform	<20 MPN per 100 ml
Treated drinking water	Total coliform	No more than 1% coliform positive samples per month
Freshwater swimming	<i>E. coli</i>	<126 MPN per 100 ml
Marine swimming	<i>E. coli</i>	<35 MPN per 100 ml

**Important Note:** Individual state standards may employ different sampling methods, indicators, averaging periods, averaging methods, instantaneous maximums and seasonal limits. MPN=most probable number. Higher or lower limits may be prescribed for different water use classes. Please consult your state water quality agency or USEPA (1998) to determine bacteria standards used in your community.

collected during the Nationwide Urban Runoff Program (NURP) in the early 1980s. He also reports a nearly identical mean fecal coliform concentration of about 22,000 colonies per 100 ml that was derived from a second database containing 25 additional stormwater monitoring studies conducted since NURP.

The Center for Watershed Protection has recently developed a third database containing 34 more recent urban stormwater monitoring studies. An analysis of the Center database indicates a slightly lower mean concentration of fecal coliform in urban stormwater of about 15,000 per 100 ml. The Center fecal coliform database is profiled in Figure 1. Nearly every individual stormwater runoff sample in the database exceeded bacteria standards, usually by a factor of 75 to 100. Some indication of the enormous storm to storm variability in fecal coliform bacteria can be seen in Figure 1, with concentrations often spanning five orders of magnitude at the same sampling location. Other data for fecal streptococci and *E. coli* are provided in Figures 2 and 3.

Arid and semi-arid regions of the country often experience higher fecal coliform levels. For example, Chang (1999) computed a flow-weighted mean fecal coliform concentration of 77,970 MPN/100 ml in 21 small urban watersheds in Austin, Texas.

It should be noted that the most extreme bacteria concentrations ( $10^5$  -  $10^6$ ) in stormwater runoff from larger catchments are usually associated with an inappropriate human discharge (e.g., failing septic system, sanitary sewer overflows or illicit connections) (Pitt, 1998).

Fecal coliform levels are generally much lower in stream baseflow than during storms, unless an inappropriate sewage discharge is present upstream (Gannon and Busse, 1989; USEPA, 1983). This is most evident at runoff monitoring stations at recently developed suburban watersheds that have few suspected sewage discharges. For example, Varner (1995) sampled fecal coliform samples at 11 stations in suburban catchments in the City of Bellevue, WA. Overall, the mean stormflow concentration of fecal coliforms (4,500 MPN/100 ml) was about nine times greater than mean baseflow concentrations (600 MPN/100 ml) for all stations.

Watershed managers should systematically assess dry weather flows from stormwater outfall pipes before they conclude that dry weather bacteria concentrations are not a concern. In some communities, as many as 10% of all pipe outfalls have dry weather flow. Even if only a few of these flows contain sewage, they can produce very high bacteria concentrations during baseflow conditions.

Fecal coliform levels are about 90% lower in runoff that occurs in winter than during the summer months, although bacteria levels can increase sharply during snowmelt events (USEPA, 1983 and Figure 4). Researchers have occasionally correlated bacteria levels with factors such as rainfall, rainfall intensity, antecedent rainfall, turbidity and suspended solids within individual urban watersheds. Few of these relationships, however, appear to be transferable from one watershed to another. Other watershed variables that may better predict bacteria levels include population density (Glennie, 1984), age of development and percent residential development (Chang, 1999).

Unlike many pollutants, fecal coliforms do not appear to be directly related to subwatershed impervious cover. For example, Hydroqual (1996) evaluated fecal coliform concentrations for seven small subwatersheds of different impervious cover in the Kensico watershed, a small drinking water reservoir for New York City. Undeveloped subwatersheds with 4% impervious cover had fecal coliform concentrations well below the 200 MPN standard, whereas watersheds ranging from 20 to 65% imperviousness exceeded the standard handily (Figure 5). While developed watersheds nearly always had greater fecal coliform concentrations than undeveloped watersheds, more impervious cover in a developed watershed was not observed to increase fecal coliform concentrations.

### Protozoan Levels in Urban Runoff

Until recently, the major sources of protozoa in surface waters were generally thought to be human sewage, dairy runoff and wildlife sources. The only study to date that has measured *Cryptosporidium* or *Giardia* in stormwater runoff found high levels of both protozoans (Stern *et al.*, 1996). David Stern and his colleagues monitored a series of agricultural and urban watersheds within the New York City water supply reservoir system, and found urban subwatersheds had slightly higher rates of *Giardia* and *Cryptosporidium* detection than agricultural subwatersheds, and a higher rate of confirmed viability (Table 3 and Stern *et al.*, 1996).

States *et al.* (1997) also found very high levels of *Cryptosporidium* and *Giardia* in storm samples collected from combined sewers in the Pittsburgh region (geometric means of 28,881 cysts/100 ml for *Giardia* and 2,013 oocysts/100 ml for *Cryptosporidium*). The protozoa were detected in virtually every sample collected from the combined sewer overflows. Sampling of protozoa is complicated by durability of their cysts and oocysts in the environment (i.e., some *Cryptosporidium* and *Giardia* cysts and oocysts persist, but are no longer viable of infecting another host). Much more sampling is needed in other regions to determine if stormwater and combined sewer runoff are major sources of *Cryptosporidium* and *Giardia*.

### Bacteria Sources in Urban Watersheds

The high concentrations of bacteria in stormwater are derived from many possible human and non-human sources. Consequently, watershed managers must investigate many different sources and source areas in order to develop an effective strategy for bacteria control. Some of the more likely bacteria sources are described in Table 4.

### Human Sources of Bacteria

The major source of bacteria in most urban waters was human sewage until the advent of modern waste-

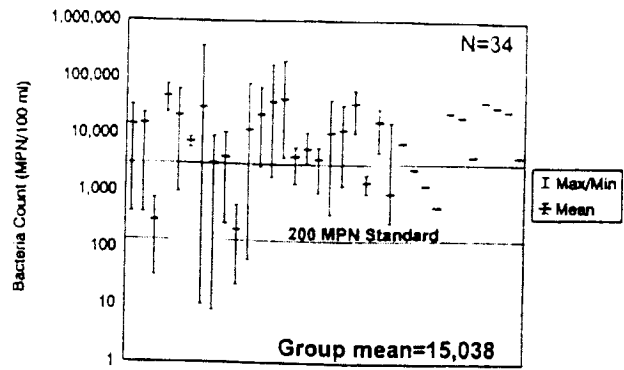

AL, AZ, ID, KY, MD, NC, NH, NY, SD, TN, TX, WA, WI

Figure 1: Fecal Coliforms in Urban Stormwater Runoff

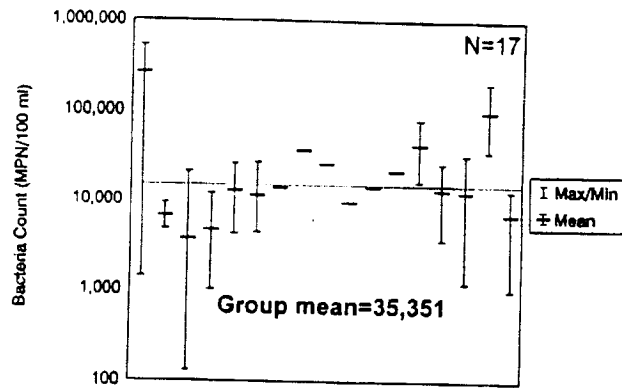

Figure 2: Fecal Streptococci in Urban Stormwater Runoff

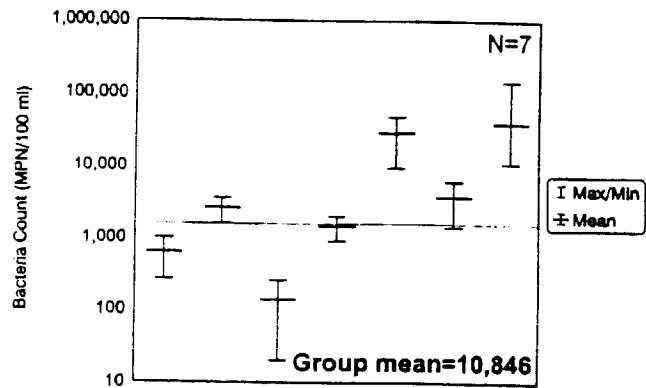

Figure 3: *E. coli* in Urban Stormwater Runoff

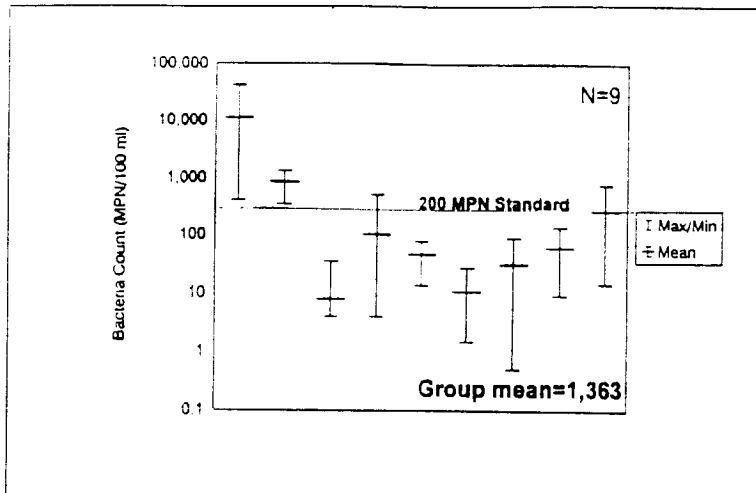

Figure 4: Fecal Coliforms in Winter Runoff

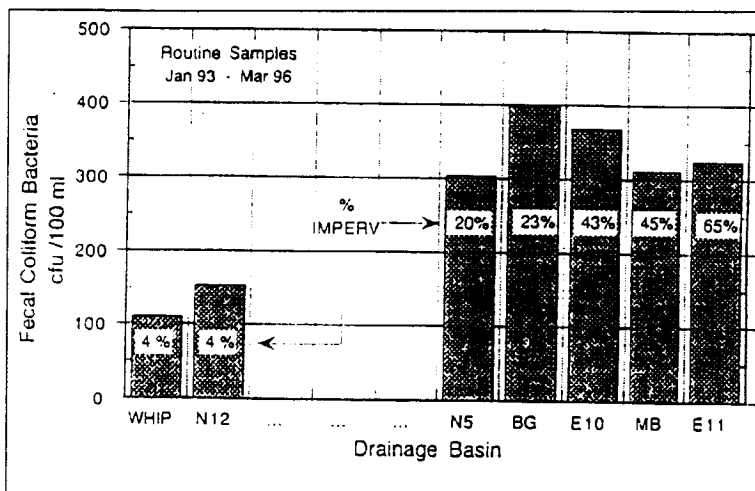

Figure 5: Fecal Coliform Levels in Watersheds of Different Impervious Cover (Hydroqual, 1996)

water treatment. Wastewater is now generally collected in a central sewer pipe and sent to a municipal plant for treatment in most urban watersheds. Ideally, wastewater treatment provides more efficient collection, conveyance, and treatment of wastewater than septic systems or package plants. In reality, many sewer systems are still an episodic or chronic source of bacteria. Potential pathways of human sewage to surface waters include combined sewer overflows, sanitary sewer overflows, illegal sanitary connections to storm drains, transient dumping of wastewater into storm drains and failing septic systems.

The potential significance of sewage as a bacteria source can be quickly grasped from Table 5, which compares typical coliform levels from several waste streams, including raw sewage, combined sewer overflows, failed septic systems, stormwater and forest runoff. Raw sewage typically is about two to three orders of magnitude "stronger" than stormwater runoff in terms of coliform production, and is four to five orders of magnitude "stronger" than forest runoff that is influenced only by wildlife sources. As a general rule, human sources of sewage should be suspected when fecal coliform concentrations are consistently above  $10^5$  (Pitt, 1998).

- *Combined sewer overflows (CSOs)*

Many older cities have a sewer system that carries both wastewater and stormwater. During some storms, the capacity of the treatment system is exceeded, and diluted wastewater is discharged directly into the surface waters without treatment. As seen in Table 5, CSOs have extremely high bacteria levels and deserve immediate attention as a bacteria source when they are found in any watershed.

- *Sanitary sewer overflows (SSOs)*

Human sewage can be introduced into surface waters even when storm and sanitary sewers are separated. Leaks and overflows are common in

Table 3: Percent Detection of *Giardia* Cysts and *Cryptosporidium* Oocysts in Subwatersheds and Wastewater Treatment Plant Effluent in the New York City Water Supply Watersheds (Stern et al., 1996)

Source water sampled (No. of sources/No. of samples)	Percent Detection			
	Total <i>Giardia</i>	Confirmed <i>Giardia</i>	Total <i>Cryptosporidium</i>	Confirmed <i>Cryptosporidium</i>
Wastewater effluent (8/147)	41.5	12.9	15.7	5.4
Urban subwatershed (5/78)	41.0	6.4	37.2	3.9
Agricultural subwatershed (5/56)	30.4	3.6	32.1	3.6
Undisturbed subwatershed (5/73)	26.0	0.0	9.6	1.4



many older sanitary sewers where capacity is exceeded, high rates of infiltration and inflow occur (i.e., outside waters gets into pipes, reducing capacity), frequent blockages occur, or are simply falling apart due to poor joints or pipe materials. Power failures at pumping stations are also a common cause of SSOs. The greatest risk of a SSO occurs during storm events; however, little comprehensive data is available to quantify SSO frequency and bacteria loads in most watersheds. The Association of Metropolitan Sewage Agencies (AMSA, 1994) estimates that about 140 overflows occur per one thousand miles of sanitary sewer lines each year (1,000 miles of sewer serves a population of about 250,000). The AMSA survey also found that 15 to 35% of all sewer lines were over capacity and could potentially overflow during storms.

• *Illicit connections to storm sewers*

Sewage can be introduced into storm sewers by accident or design. The hundreds of miles of storm and sanitary sewer pipes in a community creates a confusing underground spaghetti of utilities, so it should not be surprising that improper connections are made to the wrong sewer. For example, Johnson (1998) reported that just under 10% of all businesses in Wayne County, MI had illicit connections, with an average of 2.6 illicit connections found at each detected business. While most illicit connections did not contain raw sewage (e.g., floor drains, sinks), 11% of the Wayne County illicit connections included toilet discharges. Schmidt and Spencer (1986) found a 38% rate of illicit connections in Washtenaw County, MI, primarily among automobile-related and manufacturing businesses. It is not clear how many of these illicit connections involved sewage, as compared to wash water. Pitt and McClean (1986) detected illicit connections in about 12% of storm sewers in Toronto, and Pitt

(1998) found that 18% of storm outfalls surveyed that had dry weather flow were contaminated by human sewage in a small Alabama subwatershed.

• *Illegal dumping into storm drain system*

There is quite a bit of anecdotal evidence of illegal transient dumping of raw sewage into storm drain

**Table 4: Potential Sources of Coliform Bacteria in an Urban Watershed**

**Human Sources**

Sewered watershed

- Combined sewer overflows
- Sanitary sewer overflows
- Illegal sanitary connections to storm drains
- Illegal disposal to storm drains

Non-sewered watershed

- Failing septic systems
- Poorly operated package plant
- Landfills
- Marinas and pumpout facilities

**Non-human Sources**

Domestic animals and urban wildlife

- Dogs, cats
- Rats, raccoons
- Pigeons, gulls, ducks, geese

Livestock and rural wildlife

- Cattle, horse, poultry
- Beaver, muskrats, deer, waterfowl
- Hobby farms

**Table 5: Comparison of Bacterial Densities in Different Waste Streams (MPN/100 ml) (Pitt, 1998; Lim and Oliveri, 1982; Smith *et al.*, 1992, Horsely & Witten, Inc., 1995)**

Waste stream	Total coliform	Fecal coliform	Fecal streptococci
Raw sewage	$2.3 \times 10^7$	$6.4 \times 10^6$	$1.2 \times 10^6$
Combined sewer overflow	$10^4 - 10^7$	$10^4 - 10^6$	$10^5$
Failed septic systems	$10^4 - 10^7$	$10^4 - 10^6$	$10^5$
Urban stormwater runoff	$10^4 - 10^5$	$2.0 \times 10^4$	$10^4 - 10^5$
Forest runoff	$10^2 - 10^3$	$10^1 - 10^2$	$10^2 - 10^3$

R0079530

from septage vac trucks (i.e. honey wagons), recreational vehicles and portable toilets (Johnson, 1998). In addition, there may be inadvertent dumping from moving vehicles, such as live-stock carriers and recreational vehicles. The overall significance of illegal or inadvertent dumping as a watershed bacteria source, however, is hard to quantify.

• *Failing septic systems*

About one-fourth of all American households rely on on-site septic systems to dispose of their wastewater, which translates to about 20 million individual systems (Wilhelm *et al.*, 1994). After solids are trapped in a septic tank, wastewater is distributed through a subsurface drain field and allowed to percolate through the soil. Bacteria are effectively removed by filtering and straining water through the soil profile, if the septic system is properly located, installed and maintained. A large number of septic systems fail, however, when wastewater breaks out or passes through the soil profile without adequate treatment. The regional rate of septic system failure is reported to range from five to nearly 40%, with an average of about 10% (Table 6).

The causes of septic system failure are numerous: inadequate soils, poor design, siting, testing or inspection, hydraulic overloading, tree growth in the drain field, old age, and failure to clean out. When investigating whether septic systems are likely to be a major bacteria source in a watershed, managers should consider the following risk factors: septic systems that are older than 20 years, situated on smaller lots, service second homes or provide seasonal treatment, are adjacent to shorelines or ditches, are located on thin or excessively permeable soils, or are close to bedrock or the water table. The design life of

most septic systems is 15 to 30 years, at which point major rehabilitation or replacement is needed.

Tuthill *et al.* (1998) detected coliforms in 30 to 60% of shallow wells in Frederick County, MD, with the highest concentration found on lots of a half acre or less served by septic systems. Glasoe and Tompkins (1996) reported a much higher failure rate for septic systems situated near waterfront as compared to more upland areas. Duda and Cromartie (1982) reported a very strong relationship between the density of septic systems and shellfish bed closure in the flat coastal plain of North Carolina.

*Non-Human Bacteria Sources*

Unless an inappropriate human sewage discharge is present in an urban watershed, most of the bacteria present in storm runoff are generally assumed to be of nonhuman origin. Recent genetic studies by Alderiso *et al.* (1996) and Trial *et al.* (1993) independently concluded that 95% of fecal coliform found in urban stormwater were of nonhuman origin. Recent microbial tracking by Samadpour and Checkowitz (1998) also confirms that nonhuman sources (dogs and livestock from hobby farms) were the primary source of bacterial contamination in a lightly developed Washington watershed, although septage effluent was a secondary source.

Documented nonhuman sources of fecal coliform bacteria in urban watersheds are dogs, cats, raccoons, rats, beaver, gulls, geese, pigeons and even insects. Dogs in particular appear to be a major source of coliform bacteria and other microbes, which is not surprising given their population density, daily defecation rate, and pathogen infection rates. According to van der Wel (1995), a single gram of dog feces contains 23 million fecal coliform bacteria. Dogs have also

**Table 6: Failure Rate for Septic Systems**

Geographic location	Source	Failure rate (%)
Frederick County, MD	Tuthill, 1998	30+
Detroit, MI	Johnson, 1998	20
Wayne County, MI	Johnson, 1998	21
Oakland County, MI	Johnson, 1998	39
Florida	Hunter, 1998	5
Mason County, WA	Glasoe and Tompkins, 1996	12
Puget Sound, WA	Smayda <i>et al.</i> , 1996	10 to 25

been found to be significant hosts for *Giardia* and *Salmonella* (Pitt, 1998). The *Salmonella* infection rate for dogs and cats ranges from two to 20% according to Lim and Oliveri (1982), who also noted that dog feces were the single greatest source contributing fecal coliform and fecal strep bacteria in highly urban Baltimore catchments. Trial *et al.* (1993) reported that cats and dogs were the primary source of fecal coliforms in urban subwatersheds in the Puget Sound region. In addition, Davies and Hubler (1979) found 13% of cats and 25% of dogs were infected with *Giardia*. Pitt (1998) notes that prior studies have indicated that dogs are a significant host of *Pseudomonas aureginosa*.

Urban wildlife can also be a significant bacterial source. In highly urban areas, rats and pigeons can be a major source of bacteria (Lim and Oliveri, 1982). In more suburban watersheds, raccoons have adapted to an underground habitat within storm drain pipes, and use ledges in storm drain inlets on a temporary basis. Blankenship (1996) reported that exceedance of *E. coli* standards in a Virginia coastal area was due to the local raccoon population.

Beaver are gradually recolonizing many urban stream habitats where they had previously been extirpated (Kwon, 1997). Numerous studies have fingered beavers as a key source of *Giardia*. For example, Monzingo and Hibler (1987) detected *Giardia* in an average of 44% of beavers sampled in a Montana lodge, and also documented *Giardia* cysts in beaver ponds, pond sediments and downstream waters. Other researchers have found lower infection rates. For example, Frost *et al.* (1980) found *Giardia* in 10% of the beaver population and 40% of the muskrat population, while Davies and Hubler (1979) reported an 18% *Giardia* infection rate among beavers in Ohio.

Geese, gulls and ducks are speculated to be a major bacterial source in urban areas, particularly at lakes and stormwater ponds where large resident populations become established. Levesque *et al.* (1993) detected an increase in *E. coli* concentrations from flock of gulls roosting near a reservoir, which is not to surprising given that they have very high bacteria excretion rates (Table 7). Relatively little data is available to quantify whether geese and ducks are a major source of fecal coliforms or pathogens. Moorhead *et al.* (1998) did find high *E. coli* concentrations in a series of stormwater impoundments in West Texas that were heavily utilized by waterfowl, and other stormwater researchers often attribute high coliform levels to upstream geese or duck populations (Pitt *et al.*, 1988). Bacteria production from waterfowl are expected to be greatest in small impoundments and concrete water storage reservoirs.

Livestock can still be a major source of fecal coliform in unsewered urban watersheds, particularly those areas of the urban fringe that have horse pastures, "hobby" farms and ranchettes (Samadpour and

Checkowitz, 1998). Although these operations are very small, the stocking density is often very high, and good grazing and riparian management practices are seldom applied.

### Bacterial Survival and Growth in the Urban Drainage System

It is commonly assumed that most fecal coliform bacteria rapidly die off in the outside world in a few days. Research, however, has shown that many bacteria merely disappear from the water column and settle to bottom sediments, where they can persist for weeks or months in the warm, dark, moist and organic-rich conditions found there (Burton *et al.*, 1987). Fecal coliform levels in stream and lake sediments are routinely three to four orders of magnitude higher than those in the overlying water column (Van Donsel and Geldrich, 1971).

The same behavior has recently been noted in the bottom sediments of stormwater ponds and urban lakes (Pitt, 1998). Other researchers have documented that fecal coliform bacteria can survive and even multiply in the sediments in urban streams, ditches and drains (Burton *et al.*, 1987; Marino and Gannon, 1991). Some evidence of fecal coliform survival has been observed in catch basins (Butler *et al.*, 1995; Ellis and Yu, 1995) and also within roadway curb sediments (Sartor and Boyd, 1977; Bannerman *et al.*, 1996). Coliform bacteria also have been found to survive and grow in moist soils and leaf piles (Oliveri *et al.*, 1977). This may explain why grass swales and ditches frequently have high bacteria levels.

The strong evidence that fecal coliform bacteria can survive and even multiply in sediments indicates that the drainage network itself can become a major bacterial sink and/or source during storm events if sediments are flushed or resuspended.

### Bacterial Source Area Research

Several researchers have sampled small source-areas within the urban landscape to determine where the major nonhuman sources of fecal coliforms are found. The two most recent studies have been conducted in Madison, Wisconsin (Bannerman *et al.*, 1993) and Marquette, Michigan (Steuer *et al.*, 1997). While the bacteria levels were widely different in the two studies, both indicated that residential lawns, driveways and streets were the major source areas for bacteria (Table 8). As might be expected, rooftops and parking lots were usually smaller source areas.

The source area data lend some credence to the "Fido" hypothesis—areas of the urban landscape that are used by dogs and other pets tend to generate higher bacteria levels. In addition, both studies reported end-of-pipe bacteria concentrations that were at least an order of magnitude higher than any source area in the

R0079532

**Table 7: Bacterial Densities in Warm-Blooded Animals Feces**  
(Pitt, 1998; Godfrey, 1992; Geldrich et al., 1962)

Waste stream	Fecal coliform (Density/gm)	Fecal streptococci	Unit discharge (lbs/day)
Human	$1.3 \times 10^7$	$3.0 \times 10^6$	0.35
Cats	$7.9 \times 10^6$	$2.7 \times 10^7$	0.15
Dogs	$2.3 \times 10^7$	$9.8 \times 10^8$	0.32
Rats	$1.6 \times 10^5$	$4.6 \times 10^7$	0.08
Cows	$2.3 \times 10^5$	$1.3 \times 10^7$	15.4
Ducks	$3.3 \times 10^7$	$5.4 \times 10^7$	0.15
Waterfowl	$3.3 \times 10^7$	-	0.18 - 0.35

contributing watershed, which suggests that the storm drain system was the greatest bacterial source in the watershed, possibly as a result of the resuspension of storm drain sediments or an undetected illicit connection. The tendency for end-of-pipe bacteria levels to exceed contributing source area levels was also documented in stormwater source area monitoring in Toronto conducted by Pitt and McClean (1986).

**Priorities for Watershed Research.**

Our ability to manage bacteria problems on a watershed basis are handicapped by some major data gaps, particularly with respect to pathogen levels, bacterial source areas and the linkage between indicators and human pathogens. The following priority research areas would help to fill these gaps and be of practical value to watershed managers:

- More epidemiological research on the public health risk associated with limited exposure to urban stormwater (wading, canoeing, tubing, etc.).
- Expanded monitoring for *Giardia* and *Cryptosporidium* in stormwater runoff from sewered and unsewered catchments.
- Development of better, faster and more robust bacteria indicator tests that can reduce analysis time from the current 48 hours to two hours or less. Not only would such tests provide early warning of public health risks, but they would allow researchers to collect automated storm samples which is currently not recommended due to holding times.
- Sampling of *Cryptosporidium*, *Giardia* and *Salmonella* infection rates for different populations of dogs, cats, and other urban wildlife.
- More systematic monitoring of the frequency and volume of sanitary and storm sewer discharges to determine bacteria contributions during sanitary sewer overflows and dry weather flows.

- Development of better, faster and more accurate field methods to determine how frequently septic systems fail, and the potential bacterial load they contribute to a watershed. In addition, a standard protocol for defining septic system "failure" needs to be adopted.
- Systematic sampling of bacteria sources and reservoirs within a network of storm drains and stormwater practices should be done.
- Development of watershed models or statistical tools that can better project and quantify bacteria sources and dynamics.

**Summary**

This review of bacteria levels and sources leads to four troubling conclusions. The first is that it is exceptionally difficult to maintain beneficial uses of water in the face of even low levels of watershed development, given the almost automatic violation of bacterial water quality standards during wet and dry weather. Thus, if a watershed manager has a beach, shellfish bed or drinking water intake to protect, they can expect that even a modest amount of watershed development is likely to restrict or eliminate that use.

The second troubling conclusion is that bacteria levels in urban stormwater are so high that watershed practices will need to be exceptionally efficient to meet current fecal coliform standards during wet weather conditions. Given stormwater fecal coliform levels equivalent to the national mean of 15,000 per 100 mL, watershed practices may need to achieve nearly a 99% removal rate to meet standards. The inability of current stormwater practices, stream buffers and source controls to attain this daunting performance level is reviewed in article 67.

The third troubling conclusion is that watershed managers will need to perform a lot of detective work to narrow down the lengthy list of potential bacteria suspects. Considerable monitoring resources will need



**Table 8: Concentrations (Geometric Mean Colonies per 100 ml) of Fecal Coliforms from Urban Source Areas (Steuer et al., 1997; Bannerman et al., 1993)**

Geographic location	Marquette, MI	Madison, WI
No. of storms sampled	12	9
Commercial parking lot	4,200	1,758
High traffic street	1,900	9,627
Medium traffic street	2,400	56,554
Low traffic street	280	92,061
Commercial rooftop	30	1,117
Residential rooftop	2,200	294
Residential driveway	1,900	34,294
Residential lawns	4,700	42,093
Basin outlet	10,200	175,106

to be applied to isolate the unique mix of bacteria sources that cause water quality problems in each specific watershed, and more importantly, identify sources that are most controllable.

Lastly, it is very troubling that we understand so little about the actual relationship between bacterial indicators and the risk to public health in urban watersheds. Fecal coliform remains an imperfect indicator, yet no better alternative has yet to emerge to replace it. A great deal more research is needed to fully indicate the real public health risk of urban stormwater. See also articles 31, 67 and 125. —TRS

#### References

References denoted by an asterisk (\*) were used in the Center's bacteria database and are the sources for Figures 1 through 4.

Alderiso, K., D. Wait and M. Sobsey. 1996. "Detection and Characterization of Male-Specific RNA Coliphages in a New York City Reservoir to Distinguish Between Human and Nonhuman Sources of Contamination." In *Proceedings of a Symposium on New York City Water Supply Studies*, ed. McDonnell et al. TPS-96-2. American Water Resources Association. Herndon, VA.

AMSA. 1994. *Separate Sanitary Sewer Overflows: What Do We Currently Know?* Association of Metropolitan Sewerage Agencies, Washington, DC.

Bannerman, R., D. Owens, R. Dodds, and N. Hornewer. 1993. "Sources of Pollutants in Wisconsin Stormwater." *Water Science and Technology* 28(3-5):241-259.

Bannerman, R., A. Legg and S. Greb. 1996. *Quality of Wisconsin Stormwater 1989-1994*. USGS Open File Report 96-458. U.S. Geological Survey, Reston, VA.\*

Blankenship, K. 1996. "Masked Bandit Uncovered in Water Quality Theft." *Bay Journal*. Vol 6. No. 6. Alliance for the Chesapeake Bay.

Brabets, T. 1987. *Quantity and Quality of Urban Runoff From the Chester Creek Basin*. Anchorage, Alaska. USGS Water Resources Investigations Report 86-5312. U.S. Geological Survey, Reston, VA.\*

Burton, A. D. Gunnison and G. Lanza. 1987. "Survival of Pathogenic Bacteria in Various Freshwater Sediments." *Applied and Environmental Microbiology* 53(4) 633-638.

Butler, D., Y. Xiao, S. Karunaratne and S. Thedchanamoorthy. 1995. "The Gully Pot as a Physical, Chemical and Biological Reactor." *Water Science Technology* 31(7): 219-228.

Chang, G. 1999. *Personal communication*. Austin TX Environmental and Conservation Services Dept. City of Austin, TX.

Chang, G., J. Parrish and C. Soeur. 1990. *Removal Efficiencies of Stormwater Control Structures*. Environmental Resources Management Division, Environmental and Conservation Services Department, Austin, Texas. \*

Davies, R. and C. Hubler. 1979. "Animal Reservoirs and Cross-Species Transmission of Giardia." In *Waterborne Transmission of Giardia*. W. Jablonski and J. Huff (eds.). U.S. Environmental Protection Agency, Cincinnati, OH. pp. 104-125.

Duda, A. and K. Cromartie. 1982. "Coastal Pollution From Septic Tank Drain Fields." *Journal of the Environmental Engineering Division*. American Society of Civil Engineer. 108 EE6.

Ellis, J. and W. Yu. 1995. "Bacteriology of Urban Runoff: The Combined Sewer as a Bacterial Reactor and Generator." *Water Science Technology* 31(7): 303-310.

Evaldi, R. and B. Moore. 1992. *Stormwater Data for Jefferson County, Kentucky*. USGS Open File Report 92-638. \*

Fossum, K. and R. Davis. 1996. *Physical, Chemical, Biological and Toxicity Data for the Study of Urban Stormwater and Ephemeral Streams, Maricopa County, AZ, Water Years, 1992-1995*. USGS Open File Report 96-394. U.S. Geological Survey, Reston, VA.\*

- Frost, F., B. Plan and B. Liechty. 1980. "Giardia Prevalence in Commercially Trapped Animals." *Journal of Environmental Health* 42: 245-249.
- Gannon, J. and M. Busse. 1989. "E. coli and Enterococci Levels in Urban Stormwater, River Water and Chlorinated Treatment Plant Effluent." *Water Resources* 23(9): 1167-1176.
- Geldrich, E., R. Borden, C. Huff, H. Clark and P. Kabler. 1962. "Type Distribution of Coliform Bacteria in the Feces of Warm-Blooded Animals." *Journal Water Pollution Control Federation* (34): 295
- Glasoe, S. and J. Tompkins. 1996. "Sanitary Surveys in Mason County." *Puget Sound Notes* 39: 1-5
- Glennie, B. 1984. "Simulation of Water Pollution Generation and Abatement on Suburban Watersheds." *Water Resource Bulletin* 20(2).
- Godfrey, A. 1992. "Sources and Fate of Microbial Contaminants." In *Recreational Water Quality Management Volume 2: Freshwaters*, eds. D. Kay and R. Hanbury. Ellis Horwood, New York NY, pp. 137-154.
- Harms, L., M. Smith and K. Goddard. 1983. *Urban Runoff Control in Rapid City, South Dakota. Final Report*. Nationwide Urban Runoff Program. U.S. Environmental Protection Agency, Washington, DC.\*
- Hoos, A. 1990. *Effects of Stormwater Runoff on Local Groundwater Quality, Clarksville, TN*. USGS Water Resources Investigation Report 90-4044. U.S. Geological Survey, Reston, VA.\*
- Horsley & Witten, Inc. 1995. *Identification and Evaluation of Nutrient and Bacterial Loadings to Maquoit Bay, Brunswick and Freeport, Maine*. Final Report: Casco Bay Estuary Project, Portland, ME.
- Hunter, R. 1998. *Personal communication*. Septic System Failure Rates in Florida. Florida Dept. of Health.
- Hydroqual, Inc. 1996. *Design Criteria Report: Kensico Watershed Stormwater Best Management Facilities. Appendix C*. Report prepared for City of New York. Dept. of Environmental Protection. 240 pp.
- Johnson, B. 1998. *The Impact of On-site Sewage Systems and Illicit Connections in the Rouge River Basin*. Unpublished manuscript. Rouge River Program Office. Camp Dresser and McKee. Detroit, MI.
- Jones, S. and R. Langan. 1996. *Assessment of the Effectiveness of Permanent Stormwater Control Measures*. Final report to New Hampshire Office of State Planning. University of New Hampshire. Portsmouth, NH 22 pp.
- Kjelstrom, L. 1995. *Data for an Adjusted Regional Regression Models of Volume and Quality of Urban Stormwater Runoff in Boise and Garden City, Idaho: 1993-1994*. USGS Water Resources Investigations Report 95-4228. U.S. Geological Survey, Reston, VA.\*
- Kwon, H. 1997. "Return of the Beaver." *Watershed Protection Techniques* 2(3): 455-461.
- Levesque, et al. 1993. "Impact of Ring-billed Gull on the Microbiological Quality of a Reservoir." *Applied Environmental Microbiology* 59(4): 1128-42.
- Lim, S. and V. Olivieri. 1982. *Sources of Microorganisms in Urban Runoff*. Johns Hopkins School of Public Health and Hygiene. Jones Falls Urban Runoff Project. Baltimore, MD 140 pp. \*
- Marino, R. and J. Gannon. 1991. "Survival of Fecal Coliforms and Fecal Streptococci in Storm Drain Sediment." *Water Resources* 25(9): 1089-1098.
- Monzingo, D. and C. Hibler. 1987. "Prevalence of Giardia in a Beaver Colony and the Resulting Environmental Contamination." *Journal of Wildlife Disease* 23: 576.
- Moorhead, D., W. Davis and C. Wolff. 1998. "Coliform Densities in Urban Waters of West Texas." *Journal of Environmental Health* 60(7): 14-28.
- Olivieri, V.P., Kruse, C.W., Kawata, K., Smith, J.E., 1977. *Microorganisms in Urban Stormwater*. USEPA Report No. EPA-600/2-77-087 (NTIS No. PB-272245). Environmental Protection Agency, Washington, DC.
- Pitt, R. and J. McLean. 1986. *Toronto Area Watershed Management Study*. Humbar River Pilot Watershed Project. Ontario Ministry of the Environment.
- Pitt, R. 1998. "Epidemiology and Stormwater Management." In *Stormwater Quality Management*. CRC/Lewis Publishers. New York, NY.
- Samadpour, M. and N. Checkowitz. 1998. "Little Soos Creek Microbial Source Tracking." *Washington Water RESOURCE*. Spring, 1998. University of Washington Urban Water Resources Center.
- Schmidt, S. and D. Spencer. 1986. "Magnitude of Improper Waste Discharges in an Urban System." *Journal WPCF* 58(7): 744-758.
- Smayda, T., N. Pollison and A. Law. 1996. "Towards the Standardization of Sanitary Sewer Methods: Fecal Coliform Sampling and Criteria." *Puget Sound Notes* 39:5-10.
- Smith, R., R. Alexander and K. Lanfear. 1992. "Stream Water Quality in the Conterminous United States—Status and Trends of Selected Indicators During the 1980s. National Water Summary" 1990-1991. pp. 11-140 in *USGS Water Supply Paper 2400*. U.S. Geological Survey, Reston, VA.\*
- States, S., K. Stadterman, L. Ammon, P. Vogel, J. Baldizar, D. Wright, L. Conley and J. Sykora. 1997. "Protozoa in River Water: Sources, Occurrence and Treatment." *Journal AWWA* 89(9): 74-83.
- Steuer, J., W. Selbig, N. Hornewer and J. Prey. 1997. *Sources of Contamination in an Urban Basin in Marquette, Michigan and an Analysis of Concentrations, Loads and Data Quality*. USGS Water Resources Investigation Report 97-4242, Middleton, MI. 26 pp.
- Stern, D. 1996. "Initial Investigation of the Sources and Sinks of *Cryptosporidium* and *Giardia* Within the Watersheds of the New York City Water Supply System." In *Proceedings of a Symposium on New York City Water Supply Studies*. Eds. McDonnell et al. TPS-96-2 184 pp. American Water Resources Association, Herndon, VA.
- Tuthill, J., D. Mickle and M. Alavanja. 1998. "Coliform Bacteria and Nitrate Contamination of Wells in Major Soils of Frederick, Maryland." *Journal of Environmental Health* 60(8): 16-21.
- Trial, W. et al. 1993. "Bacterial Source Tracking: Studies in an Urban Seattle Watershed." *Puget Sound Notes*, 30: 1-3.
- USEPA, 1983. *Results of the Nationwide Urban Runoff Program*. NTIS PB-84-185552. Office of Water, Environmental Protection Agency, Washington, DC.
- USEPA, 1998. *Bacteria Water Quality Standards for Recreational waters (Freshwater and Marine); Status Report*. EPA-823-R-98-003. Office of Water, Environmental Protection Agency, Washington, DC.
- Vander Wel, B. 1995. "Dog Pollution." *The Magazine of the Hydrological Society of South Australia*, 2(1)1.
- Van Donsel, D and E. Geldreich, 1971. "Relationship of Salmonellae to Fecal Coliforms in Bottom Sediments." *Water Resources* 5: 1079-1087.
- Varner, P. 1995. *Characterization and Source Control of Urban Stormwater Quality*. City of Bellevue Utilities Department. City of Bellevue, Washington. \*
- Wilhelm, S., S. Schiff, and J. Cherry. 1994. "Biogeochemical Evolution of Domestic Wastewater in Septic Systems: I. Conceptual Model." *Groundwater* 32: 905-916.

R0079535

# Section 2: Habitat and Aquatic Diversity

## Impacts of Urbanization

The last decade witnessed a major paradigm shift in the science of watershed protection. For the first time, researchers investigated not only the quality of water, but the quality of streams, and more specifically the habitat and biodiversity within them. Researchers began systematically sampling large populations of small watersheds in order to understand the relationship between watershed factors and stream conditions. They discovered that streams in urban watersheds were fundamentally different than streams in forested, rural, or even agricultural watersheds. Moreover, they found that the amount of impervious cover could be a powerful watershed indicator, and that it exerted a profound and often irreversible impact on the quality of streams and other aquatic resources. More than 40 different scientific studies converged on a common finding: that stream, lake and wetland quality declines sharply when impervious cover in upstream watersheds exceeds 10%. Some of the key findings from this emerging body of research are summarized in article 1, and in articles 18 to 26. In general, we can now predict the following changes will occur in any stream that has more than 10% impervious cover:

- Higher peak discharge rates and greater flooding
- More frequent bankfull flooding
- Lower stream flow during dry weather
- Enlargement of the stream channel
- Greater streambank erosion
- Increased alteration of natural stream channels
- Less large woody debris (LWD) in streams
- Loss of pool and riffle structure
- Increased number of stream crossings, with greater potential to affect fish passage
- Degradation of stream habitat structure
- Decline in stream bed quality (imbedding, sediment deposition, turnover)
- Fragmentation of the riparian forest corridor
- Warmer stream temperatures
- Lower diversity of aquatic insects and freshwater mussels
- Lower diversity of native fish species
- Loss of sensitive fish species (e.g., trout, salmon)
- Lower spawning success of anadromous fish
- Decline in wetland plant and animal diversity

"The implications of this new research still reverberate through the field of watershed protection."



The implications of this new research still reverberate throughout the field of watershed protection. It has given us an ability to classify urban streams, and more important, the ability to predict how stream quality will respond to different levels of future watershed development. It has given us a common currency - impervious cover - that can be used in both our watershed plans and our site designs. The research has caused us to reshape and rethink stormwater treatment, and has put channel protection on the same par as stormwater pollution. Most of all, this new research has presented us with a daunting challenge, since

R0079536

10% impervious cover represents a fairly low density of watershed development (roughly equivalent to two acre lot residential zoning). We have discovered that we have but a modest capacity to engineer away the impacts of watershed development, and must deal with development itself. As a profession, we must become more adept in managing future land use in our watersheds.

*Research Needs for Small Watersheds*

Several lines of watershed research are critically needed to meet these challenges. A key priority is to conduct more sampling of small urban watersheds in order to detect how watershed protection tools such as stormwater treatment and buffers alter the impervious cover/stream quality relationship. In addition, further research is needed to determine if the impervious cover relationship can be extended beyond streams. Does the impervious cover model also apply to other water resources such as small estuaries, lakes and wetlands, and if so, at what levels does degradation begin? Small watershed monitoring is also needed to discover other watershed factors that influence urban stream quality, information which might be useful to the urban watershed manager. For example, how is stream quality influenced by the amount of forest or turf cover found in an urban watershed? How significant is the network of riparian forest cover in a watershed or the number of road crossings? Is the age of development an important factor? Lastly, it is vitally important that we begin to test different stormwater treatment practices and design storms in order to find out which ones can mitigate or even eliminate channel enlargement problems in urban streams.

## Habitat and Aquatic Diversity Contents

18. Effects of Urbanization on Small Streams in the Puget Sound Ecoregion .....	87
19. Dynamics of Urban Stream Channel Enlargement .....	99
20. Stream Channel Geometry Used to Assess Land Use Impacts in the Northwest .....	105
21. Habitat and Biological Impairment in Delaware Headwater Streams .....	108
22. Comparison of Forest, Urban and Agricultural Streams in North Carolina .....	111
23. Historical Change in a Warmwater Fish Community in an Urbanizing Watershed .....	115
24. Fish Dynamics in Urban Streams Near Atlanta, Georgia .....	119
25. Housing Density and Urban Land Use As Stream Quality Indicators .....	123
26. A Study of Paired Catchments Within Peavine Creek, Georgia .....	128

R0079537

# Effects Of Urbanization On Small Streams in the Puget Sound Ecoregion

by Christopher W. May, Richard R. Horner, James R. Karr, Brian W. Mar, Eugene B. Welch  
University of Washington, Seattle, Washington



The Pacific Northwest, like many areas of North America, is experiencing an increase in urban development that is rapidly expanding into remaining natural aquatic ecosystems. In the Puget Sound lowland (PSL) ecoregion, the natural resources most directly affected by watershed development are small streams and associated wetlands. Stream ecosystems are critical spawning and rearing habitat for several species of native salmonids including coho and cutthroat trout and many salmon species. These fish, especially the salmon, hold great ecological, cultural, and socioeconomic value to the peoples of the region. Despite this value, the wild salmonid resource is in considerable jeopardy of being lost to future generations. Over the past century, salmon have disappeared from about 40% of their historical range and many of the remaining populations (especially in urbanizing areas) are severely depressed (Nehlsen, *et al.* 1991). There is no one reason for this decline. The cumulative effects of land-use practices including timber-harvest, agriculture, and urbanization have all contributed significantly to this widely publicized "salmon crisis."

The effects of watershed urbanization on streams are well-documented (Leopold, 1968; Hammer, 1972; Hollis, 1975; Klein, 1979; Arnold, *et al.* 1982; Booth, 1991) and include extensive changes in basin hydrologic regime, channel morphology, and water quality. The cumulative effect of these alterations have produced an instream habitat structure that is significantly different from that in which salmonids and associated fauna have evolved. In addition, development pressure has a negative impact on riparian forests and wetlands that are essential to natural stream function. Considerable evidence about these impacts exists from studies of urban streams in the Pacific Northwest, although most previous work has fallen short of establishing cause-effect relationships among physical and chemical impacts of urbanization and the response of aquatic biota.

The most obvious manifestation of urban development is an increase in impervious cover and the corresponding loss of natural vegetation. Land clearing, soil compaction, riparian corridor encroachment, and modifications to the surface water drainage network all typically accompany urbanization. Watershed urbanization is most often quantified in terms of the propor-

tion of basin area covered by impervious surfaces (Schueler, 1994; Arnold and Gibbons, 1996). Although impervious surfaces themselves do not generate pollution, they are the major contributor to changes in watershed hydrology that drive many of the physical changes affecting urban streams. Basin imperviousness and runoff are directly related (Schueler, 1994). In previous studies, measures of total impervious area (%TIA) of about 10% have been identified as the level at which stream ecosystem impairment begins (Klein, 1979; Steedman, 1988; Schueler, 1994; Booth and Reineit, 1993). Recent studies suggest that this potential threshold may apply to wetlands as well.

### Stream Study Design

A key objective of the Puget Sound lowland stream study conducted between 1994 and 1996 was to identify the linkages between watershed conditions and instream environmental factors, including defining the functional relationships between watershed modifications and aquatic biota. The goal was to provide a set of stream quality indices for local resource managers to use in managing urban streams and minimizing resource degradation resulting from development pressure. For example, one study objective was to determine the conditions for maintaining a given population or community of organisms (such as native salmonids) at a specified level. This requires sustaining a certain set of habitat characteristics, which in turn depend on an established group of watershed conditions. A part of this overall objective was to identify any thresholds of watershed urbanization as related to instream salmonid habitat and aquatic biota. The study was designed to establish the linkages between landscape-level conditions, instream habitat characteristics, and biotic integrity. A conceptual model of this design is illustrated below:



A subset of 22 small-stream watersheds was chosen to represent a range of development levels from relatively undeveloped (reference) to highly urbanized. Researchers controlled for physiographic variability by

R0079538

studying only streams in the Puget Sound lowland ecoregion (see Figure 1 for stream locations). Total impervious surface area (%TIA), because of its integrative nature, was used as the primary measure of watershed urbanization. The attributes of the stream catchments were established using standard watershed analysis methods including geographic information system (GIS) data, aerial photographs, basin plans, and field surveys. Impervious surface coverage, riparian integrity, instream physical habitat characteristics, chemical water quality constituents, and aquatic biota were analyzed on both watershed and stream segment scales. Discharge was continuously monitored by local agencies on 10 of the study streams. Chemical water-quality monitoring (baseflow and storm events) was conducted at 23 sites on 19 of the study streams. Biological sampling (macroinvertebrates) was performed in 31 reaches on 21 of the study streams. Extensive surveys of instream physical habitat and riparian zone characteristics were made on 120 stream-segments on all 22 PSL streams, each representing local physiographic, morphologic, and sub-basin land use conditions from the headwaters to the mouth of each stream. Salmonid abundance data were obtained from public, private, and tribal sources.

All streams were third-order or smaller, ranging in basin area from three to 90 km<sup>2</sup> with headwater elevations less than 150 meters. Stream gradients were less than 3.5% (most were < 2%). The study watersheds

represented the two general types of geologic and soil conditions found in the Puget Sound region. The underlying geology and soil types are mainly a result of the last glacial period (15,000 years ago). All but three of the watersheds were dominated by poorly drained glacial till soils, with the remaining basins dominated by glacial outwash soil types (moderately well drained).

In the undisturbed, natural forested condition, PSL catchments are capable of providing adequate natural precipitation storage in the surficial "forest-duff" layer with little runoff resulting. Development typically strips away this absorbent forest soil layer and compacts the underlying soil and exposes the underlying till layer. The typical suburban development in the Pacific Northwest has been estimated to have roughly 90% less storage capacity than under naturally forested conditions (Wigmosta *et al.*, 1994). The latest (1990) stormwater mitigation and best management practices have the potential to recover only about 25% of the original storage capacity (Barker *et al.*, 1991). Because these standards affected very little new development that occurred between 1990 and the start of this study in 1994, the basin conditions observed largely reflected the pre-1990 situation with little effective stormwater control present. Therefore, no significant conclusions could be drawn about the effectiveness of current stormwater controls and regulations during this research.

## Results and Discussion

### Watershed Conditions

Watershed imperviousness ranged from undeveloped (%TIA < 5%) to highly urbanized (%TIA > 45%). Imperviousness (%TIA) was the primary measure of watershed development; however, other measures of urbanization were investigated. Calculating impervious surface area can be costly, especially if computerized methods like GIS are utilized. In addition, the land use data required for calculation of %TIA may be unavailable or inaccurate. As part of this study, a low-cost alternative to imperviousness was also investigated. Analysis demonstrated that the relationships to be discussed were very similar if development is alternatively expressed as road-density (Figure 2). This is especially relevant in that the transportation component of imperviousness often exceeds the "rooftop" component in many land-use categories (Schueler, 1994). A recent study in the Puget Sound region has shown that the transportation component typically accounts for over 60% of basin imperviousness in suburban areas (City of Olympia, 1994).

Watershed urbanization results in significant changes in basin hydrologic regime (Leopold, 1968; Hollis, 1975; Booth, 1991). This was confirmed for streams in the PSL study. The ratio of modeled two-year

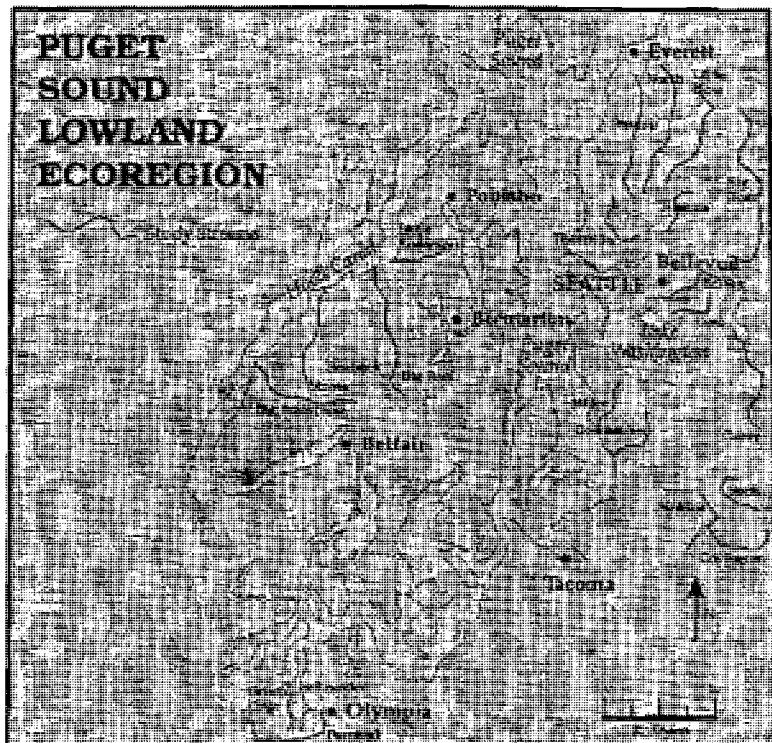

Figure 1: Puget Sound Lowland (PSL) Ecoregion

stormflow to mean winter baseflow (Cooper, 1996), was used as an indicator of development-induced hydrologic fluctuation (Figure 3). This discharge ratio is proportional to the relative stream power, and thus is representative of the hydrologic stress on instream habitats and biota exerted by stormflow relative to baseflow conditions. The modified basin hydrologic regime was found to be one of the most influential changes resulting from watershed urbanization in the PSL region.

In addition to an increase in basin imperviousness and the resulting stormwater runoff, urbanization also affects watershed drainage-density (km of stream per km<sup>2</sup> of basin area). This was first investigated by Graf (1977). Natural, pre-development drainage-density (DD) was calculated using historic topographic maps. This was compared to the current, urbanized DD which included both the loss of natural stream channels (mostly first-order and ephemeral channels lost to grading or construction) and the increase in artificial "channels" due to road-crossings and stormwater outfalls. Not surprisingly as imperviousness increases above the eight to 10% level in study watersheds so does the number of road crossings and stormwater outfalls per kilometer at a steady rate. The ratio of urban to natural drainage density was used as an indicator of urban impact.

#### Riparian Conditions

The natural riparian corridors along Pacific Northwest streams are among the most diverse, dynamic, and complex ecosystems in the region. Natural riparian integrity is characterized by wide buffers, a near-continuous corridor, and mature, coniferous forest as the dominant vegetation. The riparian corridor is frequently disturbed by flooding events, creating a naturally complex landscape.

Not surprisingly, riparian conditions were also strongly influenced by the level of development in the surrounding landscape. The impact of development activities on riparian corridors can vary widely. Very recently, regional development regulations did not specifically address riparian buffer requirements. Sensitive area ordinances, now in effect in most local municipalities, typically require riparian buffers of 30 to 50 meters (100 to 150 feet) in width. These recently adopted regulations had little influence on the urbanized streams in the PSL study. In general, wide riparian buffers were found only in undeveloped or rural stream watersheds (Figure 4). The actual size of riparian buffer needed to protect the ecological integrity of the stream system is difficult to establish (Schueler, 1995). In most cases, minimum buffer width "required" depends on the resource or beneficial use of interest and the quality of the existing riparian vegetation (Castelle *et al.*, 1994).

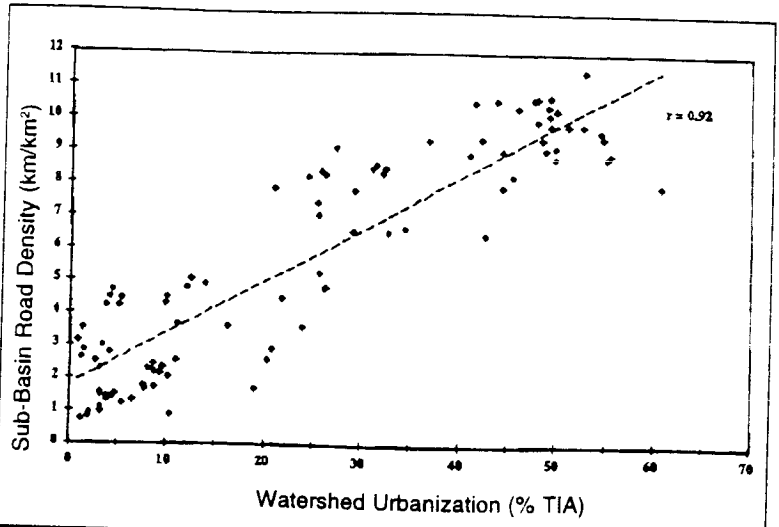

Figure 2: Relationship Between Urbanization (%TIA) and Sub-Basin Road-Density in PSL Streams

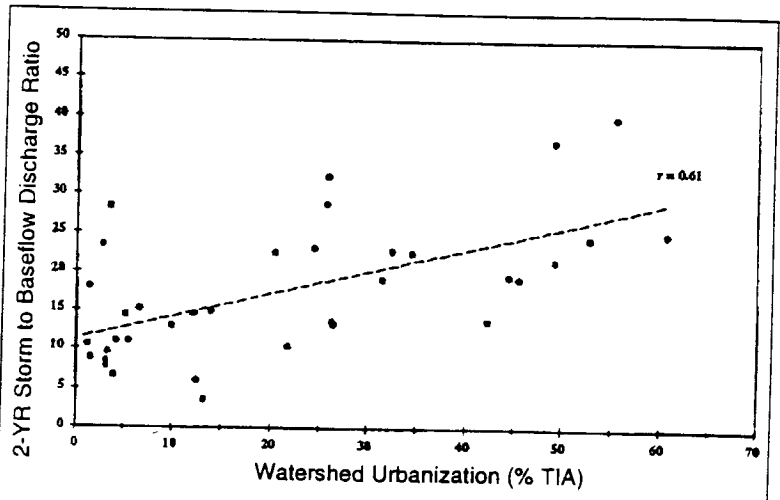

Figure 3: Change in Basin Hydrologic Regime with Urbanization in PSL Streams

Encroachment into the riparian buffer zone is pervasive, continuous, and extremely difficult to control. At the same time, riparian forests and wetlands, if maintained, appear to have a significant capacity to mitigate some of the adverse effects of development. A buffer width of less than 10 meters is generally considered functionally ineffective (Castelle *et al.*, 1994). The fraction of riparian buffer less than 10 meters wide was used as a measure of riparian zone encroachment. In general, only streams in natural, undeveloped basins (%TIA < 10%) had less than 10% of their buffer in a nonfunctional condition. As watershed urbanization (%TIA) increased, riparian buffer encroachment also increased proportionally. The most highly urbanized streams (%TIA > 40%) in this study, generally had a large

portion (upwards of 40%) of their buffers in a nonfunctional condition.

The longitudinal continuity or connectivity of the riparian corridor is at least as important as the lateral riparian buffer width. A near-continuous riparian zone is the typical natural condition in the Pacific Northwest (Naiman, 1992). Fragmentation of the riparian corridor in urban watersheds can come from a variety of human impacts, the most common and potentially damaging being road crossings. In the PSL stream study, the number of stream crossings (roads, trails, and utilities) increased in proportion to basin development intensity. All but one undeveloped stream (%TIA < 10%) had, on average, less than one riparian break per km of stream. Of the highly urbanized streams (%TIA > 40%), all but one had greater than two breaks per kilometer. Based on current development patterns in the PSL, only rural land use consistently maintained breaks in the riparian corridor to <2 per kilometer of stream length. In general, the

more fragmented and asymmetrical the buffer, the wider it needs to be to perform the desired functions (Barton *et al.*, 1985).

The riparian zone was also examined on a qualitative basis. Mature forest, young forest, and riparian wetlands were considered "natural" as opposed to residential or commercial development. From an ecological perspective, mature forest or riparian wetlands are the two most ecologically functional riparian conditions in the Pacific Northwest (Gregory *et al.*, 1991). In the 22 PSL streams, riparian maturity was also found to be strongly influenced by watershed development. Only the natural streams (%TIA < 5%) had a substantial portion of their riparian corridor as mature forest (40% or greater), while urban streams consistently had little mature riparian area (Figure 5). In addition, none of the urbanized PSL streams retained more than 25% of their natural floodplain area.

#### Chemical Water Quality

Chemical water quality constituents were monitored under baseflow and stormflow conditions. Storm event mean concentrations of several chemical constituents were found to be related to both storm size (magnitude and intensity) and basin imperviousness (Bryant, 1995; Horner *et al.*, 1996). However, water quality criteria were rarely violated except in the most highly urbanized watersheds (%TIA > 45%). Total phosphorus (TP) and total suspended solids (TSS) also showed similar relationships. Sediment, zinc and lead also indicated a relationship with urbanization, again showing the highest concentrations in the most developed basins, although all were still below sediment quality guidelines. As with other recent studies (Bannerman *et al.*, 1993; Pitt *et al.*, 1995), these findings indicate that chemical water quality of urban streams is generally not significantly degraded at the low impervious levels, but may be a more important factor in streams draining highly urbanized watersheds.

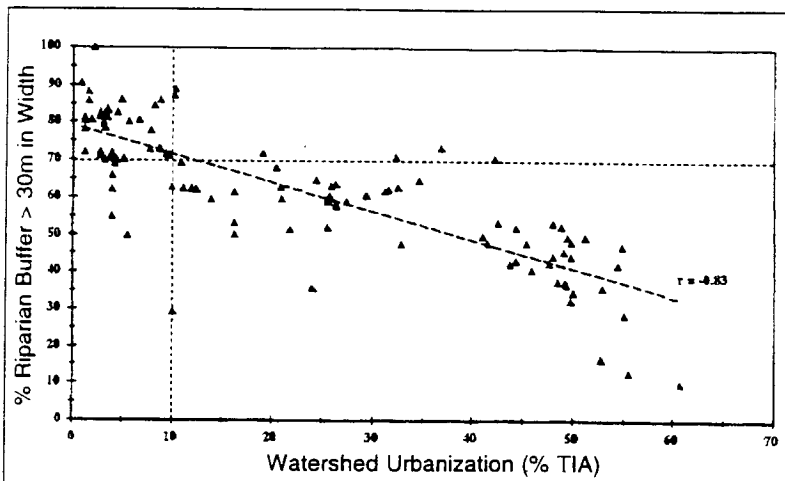

Figure 4: Relationship Between Riparian Buffer Width and Basin Urbanization (%TIA) in PSL Streams

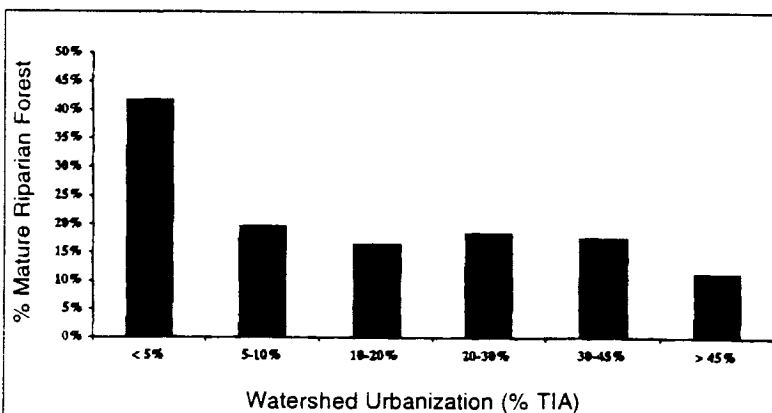

Figure 5: Relationship Between Watershed Urbanization (%TIA) and Riparian Quality (Maturity) in PSL Streams

#### Instream Salmonid Habitat Characteristics

Large woody debris (LWD) is a ubiquitous component in streams of the Pacific Northwest. There is no other structural component as important to salmonid habitat, especially in the case of juvenile coho (Bisson *et al.*, 1988). LWD performs critical functions in forested lowland streams, including dissipation of flow energy, streambank protection, streambed stabilization, sediment storage, and providing instream cover and habitat diversity (Bisson *et al.*, 1987; Masser *et al.*, 1988; Gregory *et al.*, 1991). Although the influence of LWD may change over time, both functionally and spatially, its overall importance to salmonid habitat is significant and persistent.

Both the prevalence and quantity of LWD declined with increasing basin urbanization (Figure 6a). At the



same time, measures of salmonid rearing habitat, including percent of pool area, pool size, and pool frequency, were strongly linked to the quantity and quality of LWD in PSL streams. While LWD quantity and quality were negatively affected by urbanization, even many of the natural, undeveloped streams also had a lack of LWD (especially very large LWD). This deficit appears to be a residual effect of historic timber-harvest and "stream-cleaning" activities. Nevertheless, with few exceptions (habitat restoration sites), high quantities of LWD occurred only in streams draining undeveloped basins (%TIA < 5%). It appears that stream restoration in the PSL should include enhancement of instream LWD, including addressing the long-term LWD recruitment requirements of the stream ecosystem.

An intact and mature riparian zone is the key to maintenance of instream LWD (Masser *et al.*, 1988; Gregory *et al.*, 1991). The lack of functional quantities of LWD in PSL streams was significantly influenced by the loss of riparian integrity (Figure 6b). In general, except for restoration sites, higher quantities of LWD were found only in stream-segments with intact upstream riparian corridors. In addition, LWD quality was strongly influenced by riparian integrity. Very large, stable pieces of LWD (greater than 0.5 meter in diameter) were found only in stream segments surrounded by mature, coniferous riparian forests (Figure 7). This natural LWD historically provided stable, long-lasting instream structure for salmonid habitat and flow mitigation (Masser *et al.*, 1988).

The stream bottom substratum is critical habitat for salmonid egg incubation and embryo development, as well as being habitat for benthic macroinvertebrates. Streambed quality can be degraded by deposition of fine sediment, streambed instability due to high flows, or both. Although the redistribution of streambed particles is a natural process in gravel-bed streams, excessive scour and aggradation often result from excessive flows. Streambed stability was monitored using bead-type scour monitors installed in salmonid spawning riffles in selected reaches (Nawa and Frissell, 1993). Basin urbanization in PSL streams was found to have the potential to cause locally excessive scour and fill. Urban streams in the PSL with gradients greater than 2% and lacking in LWD, were found to be more susceptible to scour than their undeveloped counterparts.

Streambank erosion was also far more common in urbanized PSL streams than in streams draining undeveloped watersheds. Using a survey protocol similar to Booth (1996), all stream segments were evaluated for streambank stability. Stream segments with >75% of the reach classified as stable were given a score of four. Between 50% and 75% stable banks were scored as a three, 25-50% as a two, and <25% as a one. Artificial streambank protection (riprap), shown in the photo in Figure 7, was considered a sign of bank instability and graded accordingly. Only two undeveloped, reference

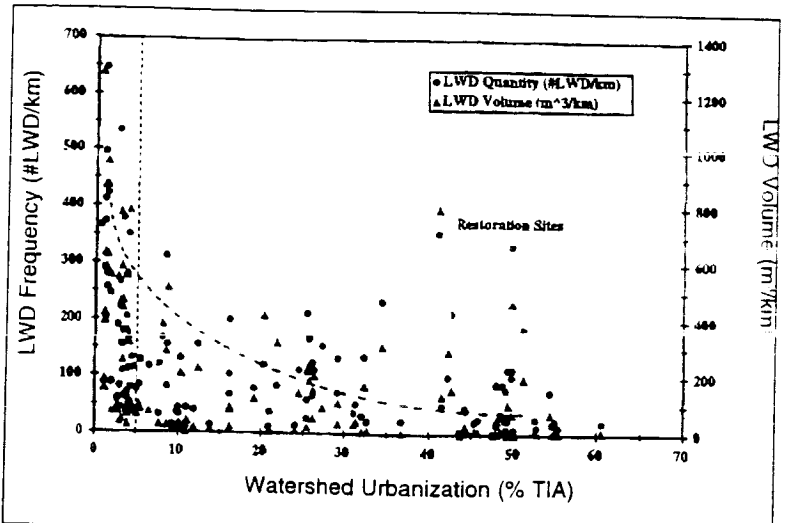

Figure 6a: LWD Quantity and Watershed Urbanization (%TIA) in PSL Streams

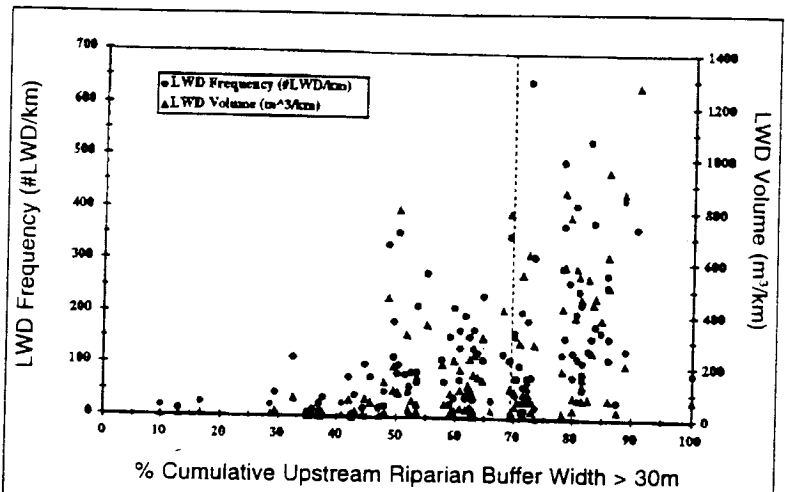

Figure 6b: LWD Quantity and Riparian Integrity In PSL

(%TIA < 5%) stream segments had a stability rating less than three. In the five to 10% basin imperviousness range, streambank ratings were generally ranked three or four. When the sub-basin impervious area was between 10 and 30% there was a fairly even mixture of streambank conditions from stable and natural to highly eroded or artificially "protected." Above 30% TIA, there were no segments with a streambank stability rating of four and very few with a rating of three. These outliers were found only in segments with intact and wide riparian corridors. Artificial streambank protection (riprap) was a common feature of all highly-urbanized streams. Overall, the streambank stability rating was inversely correlated with cumulative upstream basin %TIA and even more closely correlated with development within the segment itself, perhaps reflecting the

local effects of construction and other human activities. Streambank stability is also influenced by the condition of the riparian vegetation surrounding the stream. In this study, the streambank stability was related to the width of the riparian buffer and inversely related to the number of breaks in the riparian corridor. While not completely responsible for the level of streambank erosion, basin urbanization and loss of riparian vegetation, contribute to the instability of streambanks.

Results of fine sediment sampling (McNeil method) indicated that urbanization can result in degradation of streambed habitat. Fine sediment levels (% fines) were related to upstream basin urban development, but the variability, even in undeveloped reaches, was quite high (Wydzga, 1997). Nevertheless, percent fines did not exceed 15% until %TIA exceeded 20%. In the highly urbanized basins, the percent fines were consistently > 20% except in higher gradient reaches where sediment was presumably flushed by high stormflows.

The intragravel dissolved oxygen (IGDO) was also monitored as an integrative measure of the deleterious effect of fine sediment on salmonid incubating habitat. A significant impact of fine sediment on salmonids is the degradation of spawning and incubating habitat (Chapman, 1988). The incubation period represents a critical and sensitive phase of the salmonid life cycle. A high percentage of fine sediment can effectively clog the interstitial spaces of the substrata and reduce water flow to the intragravel region. This can result in reduced levels of IGDO and a buildup of metabolic wastes, leading to even higher mortality. Elevated fine sediment levels can also have various sub-lethal effects on developing salmonids which may reduce the odds of survival in later life stages (Steward, 1983).

While low IGDO levels are typically associated with fine sediment intrusion into the salmonid redd, local conditions can have a strong influence on intragravel conditions as well as the distribution of fine sediment

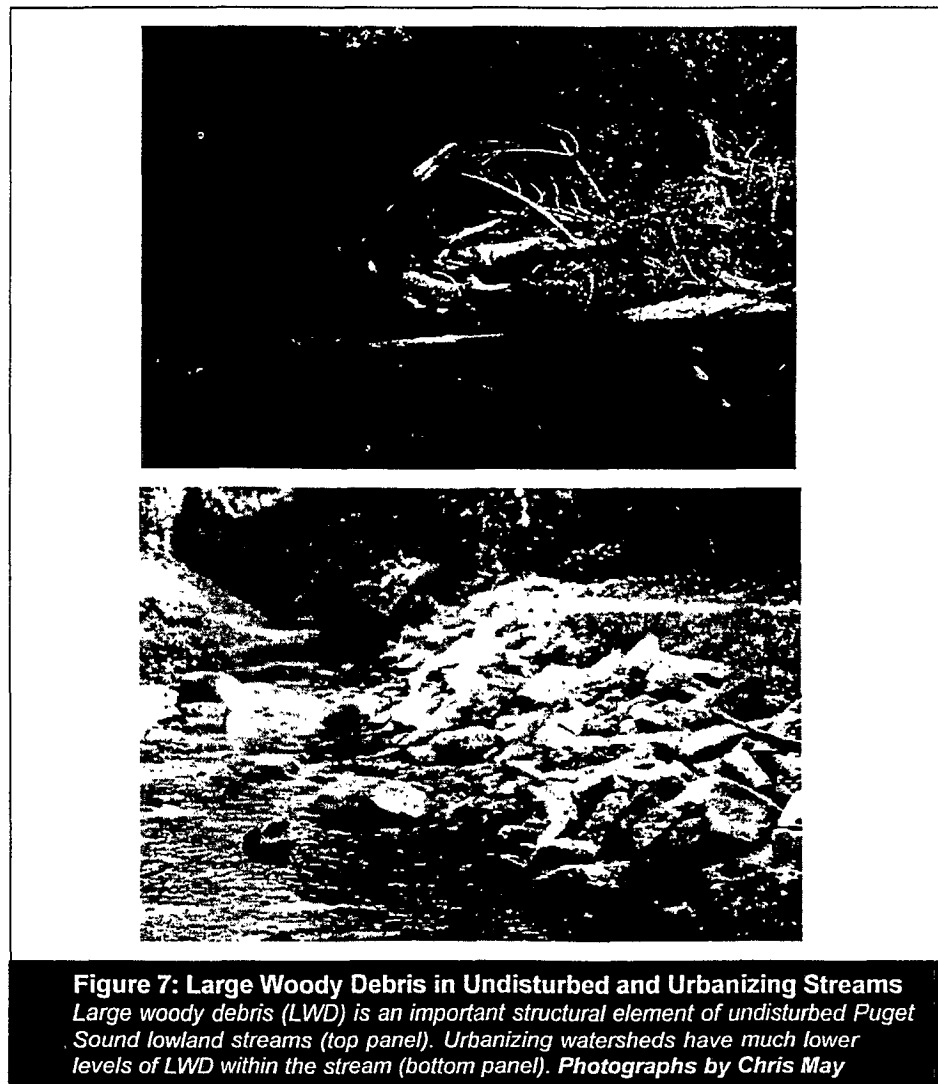

(Chapman, 1988). Spawning salmonids themselves can also reduce the fine sediment content of the substrata, at least temporarily. Measurement of instream dissolved oxygen (DO) coincident with IGDO allowed for the calculation of a IGDO/DO interchange ratio (Figure 8). In all but one case, the mean interchange ratio was > 80% in the undeveloped streams. Once TIA increased above 10%, a great majority of the reaches had a mean interchange ratio well below 80% (as low as 30%). While these DO levels are not lethal, low IGDO levels during embryo development can reduce survival to emergence (Chapman, 1988). Several urbanized stream-segments had unexpectedly high (>80%) IGDO concentrations (Figure 8). All of these segments were associated with intact riparian corridors and upstream riparian wetlands. Generally, these reaches also had stable streambanks and adequate levels of instream LWD.

Coho salmon rely heavily on small lowland streams and associated off-channel wetland areas during their rearing phase (Bisson *et al.*, 1988). They are the only species of salmon that overwinter in the small streams of the PSL. Cutthroat trout are commonly found in almost all small streams in the Pacific Northwest. Cutthroat and coho are sympatric in many small streams and as such are potential competitors (adult cutthroat also prey on juvenile coho). In general, habitat, rather than food, is the limiting resource for most salmonids in the region (Groot and Margolis, 1991). In urban streams of the PSL, rearing habitat appears to be limiting. This study found all but the most pristine (%TIA < 5%) lowland streams had significantly less than 50% of stream habitat area as pools. In addition, the fraction of cover on pools decreased in proportion to sub-basin development. Coho rear primarily in pools with high habitat complexity, abundant cover, and with LWD as the main structural component (Bisson *et al.*, 1988). Urbanization and loss of riparian forest area significantly reduced pool area, habitat complexity, and LWD in PSL streams.

*Biological Integrity*

The biological condition of the benthic macroinvertebrate community was expressed in terms of a multi-metric PSL Benthic Index of Biotic Integrity (B-IBI) developed by Kleindl (1995) and Karr (1991). The abundance ratio of juvenile coho salmon to cutthroat trout (Lucchetti and Fuerstenberg, 1993) was used as a measure of salmonid community integrity. Figure 9 shows the direct relationship between urbanization (%TIA) and biological integrity, using both measures. Only undeveloped reaches (%TIA < 5%) exhibited an B-IBI of 32 or greater (45 being the maximum possible score). There also appears to be rapid decline in biotic integrity with the onset of urbanization. At the same time, it appears unlikely that streams draining highly urbanized sub-basins could maintain a B-IBI greater than 15 (minimum B-IBI is nine). B-IBI scores between 25 and 32 were

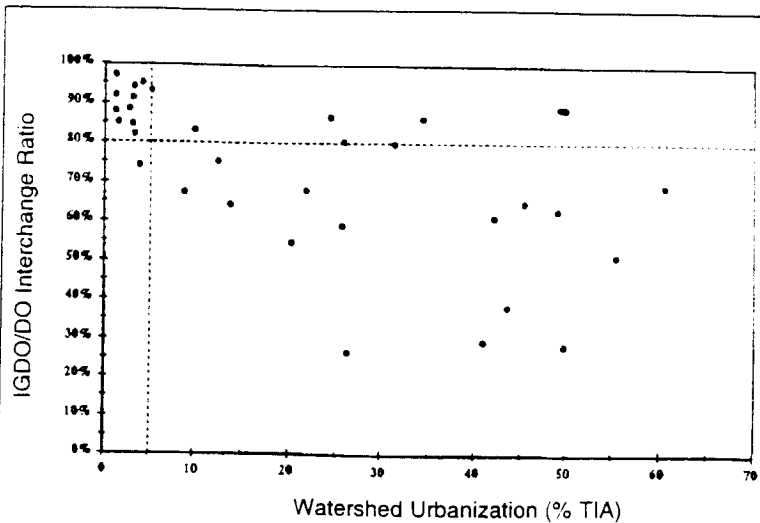

The IGDO/DO Ratio is an indicator of sediment intrusion into spawning

**Figure 8: Relationship Between Urbanization and Mean Intragravel Dissolved Oxygen (IGDO) Instream Dissolved Oxygen Ratio in PSL Streams**

associated with reaches having a %TIA < 10%, with eight notable exceptions (Figure 9). These eight reaches had sub-basin %TIA values in the 25 to 35% (suburban) range and yet each had a much higher biological integrity than other streams at this level of development. All eight had a large upstream fraction of intact riparian wetlands and all but one had a large upstream fraction of wide riparian buffer (> 70% of the stream corridor with buffer width > 30 m = 100 feet). These observations indicate that maintenance of a wide, natural riparian corridor may mitigate some of the effects of watershed urbanization.

Urbanization also appears to alter the relationship between juvenile coho salmon and cutthroat trout. In this study, coho tended to dominate in undeveloped (%TIA < 5%) streams, while cutthroat were more tolerant of conditions found in urbanized streams. In 11 study streams where data was available, natural coho dominance (cutthroat:coho ratio > 2) was seen only at very low watershed development levels. Due to the lack of data, a more specific development threshold could not be established. Nevertheless, it is significant that both salmonid and macroinvertebrate data indicate that a substantial loss of biological integrity occurs at a very low level of urbanization. These results confirmed the findings of earlier regional studies.

Given that relationships were identified between basin development conditions and both instream habitat characteristics and biological integrity, it is reasonable to hypothesize that similar direct associations exist between physical habitat and biological integrity. As a general rule, instream habitat conditions (both quantity and quality) correlated well with the B-IBI and the

R0079544

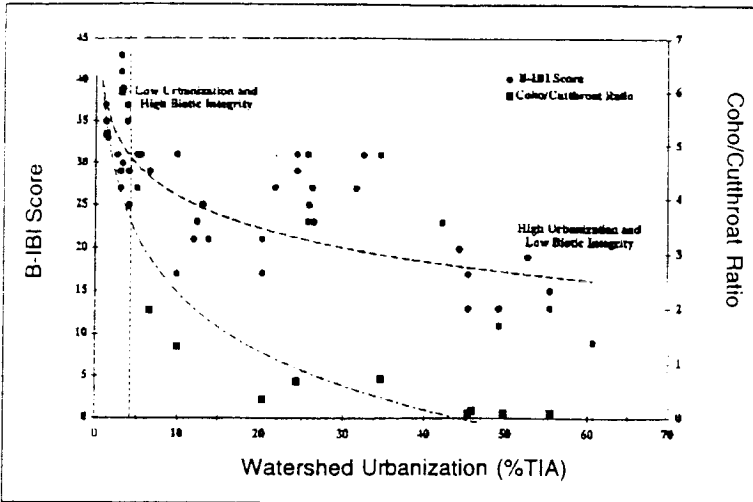

Figure 9: Relationship Between Instream Habitat Quality and Biotic Integrity

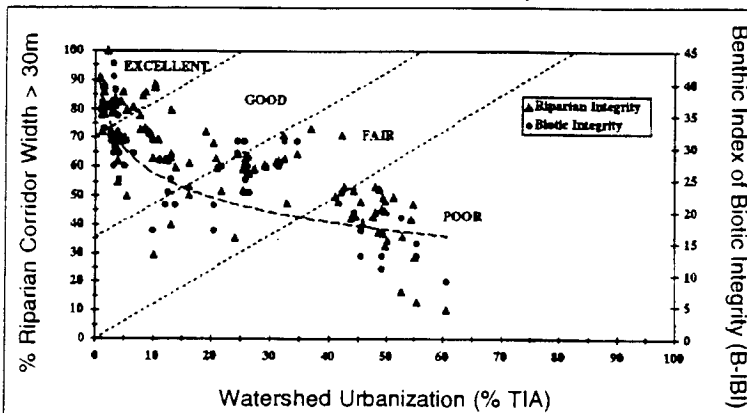

Figure 10: Relationship Between Basin Development, Riparian Buffer Width, and Biological Integrity in PSL Streams

coho:cutthroat ratio. Measures of spawning and rearing habitat quality were closely related to the coho:cutthroat ratio. As might be expected, measures of streambed quality were also closely related to the B-IBI (benthic macroinvertebrates). Chemical water quality may also influence aquatic biota at higher levels of watershed urbanization.

In addition to the quantitative habitat measures, a multi-metric Qualitative Habitat Index (QHI) was also developed for PSL streams. This index assigns scores of poor (1), fair (2), good (3), and excellent (4) to each of 15 habitat-related metrics, then sums all 15 metrics for a final reach-level score (minimum score of 15 and maximum score of 60). The QHI is similar in design to that which is used in Ohio (Rankin 1989) and as part of the U.S. EPA Rapid Bioassessment Protocol (Plafkin *et al.*, 1989). As was expected, biological integrity was directly proportional to instream habitat quality. Coho dominance is consistent with a B-IBI > 33 and a QHI > 47;

conditions found only in natural, undeveloped streams. These results were consistent with the findings of a similar study in Delaware (Maxted *et al.*, 1994). The QHI has the advantage of being simpler (less costly) than more quantitative survey protocols, but may not meet the often rigorous requirements of resource managers. However, as a screening tool, it certainly has merit.

A major finding of this study was that wide, continuous, and mature-forested riparian corridors appear to be effective in mitigating at least some of the cumulative effects of adjacent basin development. Using the B-IBI as the primary measure of biological integrity, Figure 10 illustrates how the combination of riparian buffer condition and basin imperviousness explains much of the variation in stream quality. These observations suggest a set of possible stream quality zones similar to those proposed by Steedman (1988). Excellent (natural) stream quality requires a low level of watershed development and a substantial amount of intact, high-quality riparian corridor. If a "good" or "fair" stream quality is acceptable, then greater development may be possible with an increasing amount of protected riparian buffer required. Poor stream quality is almost guaranteed in highly urbanized watersheds or where riparian corridors are impacted by human activities such as development, timber-harvest, grazing, or agriculture. Because of the mixture of historical development practices and resource protection strategies included in this study, it was difficult to make an exact judgment as to how much riparian corridor is appropriate for each specific development scenario. More intensive research is needed in this area.

### Summary

Results of the PSL stream study have shown that physical, chemical, and biological characteristics of streams change with increasing urbanization in a continuous rather than threshold fashion. Although the patterns of change differed among the attributes studied and were more strongly evident for some than for others, physical and biological measures generally changed most rapidly during the initial phase of the urbanization process as %TIA exceeded the five to 10% range. As urbanization progressed, the rate of degradation of habitat and biologic integrity usually became more constant. There was also direct evidence that altered watershed hydrologic regime was the leading cause for the overall changes observed in instream physical habitat conditions.

Water quality constituents and metal sediment concentrations did not follow this pattern. These variables changed little over the urbanization gradient until imperviousness (%TIA) approached 40%. Even then, water column concentrations did not surpass aquatic life criteria, and sediment concentrations remained far below freshwater sediment guidelines. Once

urbanization increased above the 50% level, most pollutant concentrations rose rapidly, and it is likely that the role of water and sediment chemical water quality became more important biologically.

It is also apparent that, for almost all PSL streams, large woody debris quantity and quality must be restored for natural instream habitat diversity and complexity to be realized. Of course, prior to undertaking any habitat enhancement or rehabilitation efforts, the basin hydrologic regime must be restored to near-natural conditions. Results suggest that resource managers should concentrate on preservation of high-quality stream systems through the use of land-use controls, riparian buffers, and protection of critical habitat. Enhancement and mitigation efforts should be focused on watersheds where ecological function is impaired but not entirely lost.

Biological community alterations in urban streams are clearly a function of many variables representing conditions in both the immediate and more remote environment. In addition to urbanization level, a key determinant of biological integrity appears to be the quantity and quality of the riparian zone available to buffer the stream ecosystem, in some measure, from negative influences in the watershed (Figure 10). Instream habitat conditions also had a significant influence on instream biota. Streambed quality, including fine sediment content and streambed stability, clearly affected the benthic macroinvertebrate community (as measured by the B-IBI). The composition of the salmonid community was also influenced by a variety of instream physio-chemical attributes. In the PSL region, management of all streams for coho (and other sensitive salmonid species) may not be feasible. Management for cutthroat trout may be a more viable alternative for streams draining more highly urbanized watersheds. The apparent linkage between watershed, riparian, instream habitat, and biota shown here supports management of aquatic systems on a watershed scale. The accompanying box outlines some key watershed management recommendations for PSL streams.

The findings of this research indicate that there is a set of necessary, though not by themselves sufficient, conditions required to maintain a high level of stream quality or ecological integrity (Table 1). If maintenance of that level is the goal, then this set of enabling conditions constitutes standards that must be achieved if the goal is to be met. For the PSL streams, imperviousness must be limited (<5-10% TIA), unless mitigated by extensive riparian corridor protection and stormwater management. Downstream changes to both the form and function of stream systems appear to be inevitable unless limits are placed on the extent of urban development. Stream ecosystems are not governed by a set of absolute parameters, but are dynamic and complex systems. We cannot "manage" streams, but instead

should work more as "stewards" to maintain naturally high stream quality. Preservation and protection of high-quality resources, such as salmon, should be a priority. The complexity and diversity of salmonid life cycles, and our limited understanding of them, merits additional caution in our efforts to mediate the effects of urbanization in stream environments. Engineering solutions in urban streams have utility in some situations, but in most cases cannot fully mitigate the effects of development. Rehabilitation and enhancement of aquatic resources will almost certainly be required in all but the most pristine watersheds.

#### References

- Arnold, C.L., P.J. Boison, and P.C. Patton. 1982. "Sawmill Brook: An Example of Rapid Geomorphic Change Related to Urbanization." *Journal of Geology* 90:155-166.
- Arnold, C.L. and C.J. Gibbons. 1996. "Impervious Surface Coverage: The Emergence of a Key Environmental Indicator." *Journal of the American Planning Association* 62(2):243-258.
- Bannerman, R., D.W. Owens, R.B. Dodds, and N.J. Hornewer. 1993. "Sources of Pollutants in Wisconsin Stormwater." *Water Science and Technology* 28:241-259.
- Barker, B.L., R.D. Nelson, and M.S. Wigmosta. 1991. "Performance of Detention Ponds Designed According to Current Standards." *PSWQA Puget Sound Research '91 Conference Proceedings*. Seattle, WA. p. 64-70.
- Barton, D.R., W.D. Taylor, and R.M. Biette. 1985. "Dimensions of Riparian Buffer Strips Required to Maintain Trout Habitat in Southern Ontario Streams." *North American Journal of Fisheries Management* 5:364-378.
- Bisson, P.A., R.E. Bilby, M.D. Bryant, C.A. Dolloff, G.B. Grette, R.A. House, M.L. Murphy, K.V. Koski, and J.R. Sedell. 1987. "Large Woody Debris in Forested Streams in the Pacific Northwest: Past, Present, and Future." In: Salo, E.O. and T.W. Cundy, editors. *Streamside Management: Forestry and Fisheries Interactions, Contribution No. 57*. UW Forestry Institute. Seattle, WA. pp. 143-190.
- Bisson, P.A., K. Sullivan, and J.L. Nielsen. 1988. "Channel Hydraulics, Habitat Use, and Body Form of Juvenile Coho Salmon, Steelhead, and Cutthroat Trout in Streams." *Transactions of the American Fisheries Society* 117:262-273.
- Booth D.B. 1991. "Urbanization and the Natural Drainage System—Impacts, Solutions, and Prognosis." *The Northwest Environmental Journal* 7:93-118.

R0079546

**Table 1: PSL Stream Study Recommendations for Ensuring Natural Stream Quality****Land Use and Transportation**

- Reduce watershed imperviousness, especially targeting transportation-related surfaces and compacted pervious areas.
- Preserve at least 50% of the total watershed surface area as natural forest cover.
- Maintain urbanized stream system drainage-density to within 25% of pre-development conditions.
- Replace culverted road-crossings with bridges or arched culverts with natural streambed material.

**Riparian Zone**

- Limit stream crossings by roads or utility lines to less than 2 per km of stream length and strive to maintain a near-continuous riparian corridor.
- Ensure that at least 70% of the riparian corridor has a minimum buffer width of 30 m and utilize wider (100 m) buffers around more sensitive or valuable resource areas.
- Limit encroachment of the riparian buffer zone through education and enforcement (< 10% of the riparian corridor should be allowed to have a buffer width < 10 m).
- Protect and enhance headwater wetlands and off-channel riparian wetland areas as natural stormwater storage areas and valuable aquatic habitat resources (buffers).
- Actively manage the riparian zone to ensure a long-range goal of at least 60% of the corridor as mature, native coniferous forest.

**Stormwater and Water Quality**

- Allow no development in the active (100-year) floodplain area of streams. Allow the stream channel freedom of movement within the floodplain area.
- Continuously monitor streamflow and maintain two-year stormflow/baseflow discharge ratio much less than 20.
- Allow no stormwater outfalls to drain directly to the stream without first being treated by stormwater quality and quantity control facilities.
- Retrofit existing stormwater practices or replace with regional (sub-basin) stormwater control facilities with the goal of restoring the natural hydrologic regime.
- Adopt a set of regionally-specific stream assessment protocols including standardized biological sampling.
- Tailor monitoring of instream physical conditions to the specific situation. Habitat surveys should include a measure of rearing habitat (LWD and/or pools) and a measure of spawning/incubating habitat (% fines and/or IGDO); standard channel morphological characteristics should be measured; scour monitoring can be used to evaluate local streambed stability in association with specific development activity.



- Booth, D.B., and L. Reinelt. 1993. "Consequences of Urbanization on Aquatic Systems—Measured Effects, Degradation Thresholds, and Corrective Strategies." In: *Proceedings of the Watershed '93 Conference*. U.S. GPO, Washington, D.C.
- Booth, D.B. 1996. "Stream Channel Geometry Used to Assess Land Use Impacts in the PNW." *Watershed Protection Techniques* 2 (2): 345-347.
- Bryant, J. 1995. *The Effects of Urbanization in Water Quality in Puget Sound Lowland Streams*. Masters Thesis, University of Washington, Seattle, WA. 128 pp.
- Castelle, A.J., A.W. Johnson, and C. Conolly. 1994. "Wetland and Stream Buffer Size Requirements—A Review." *Journal of Environmental Quality* 23 (5):878-882.
- City of Olympia. 1994. *Impervious Surface Reduction Study*. Public Works Department, City of Olympia, WA (POC: Ceder Wells). 183 pp.
- Chapman, D.W. 1988. "Critical Review of Variables Used to Define Effects of Fines in Redds of Large Salmonids." *Transactions of the American Societies* 117:1-21.
- Cooper, C. 1996. *Hydrologic Effects of Urbanization on Puget Sound Lowland Streams*. Masters Thesis, University of Washington, Seattle, WA.
- Graf, W.L. 1977. "Network Characteristics in Suburbanizing Streams." *Water Resources Research* 13(2): 459-463.
- Gregory, S.V., F.J. Swanson, W.A. McKee, and K.W. Cummins. 1991. "An Ecosystem Perspective of Riparian Zones: Focus on Links between Land and Water." *Bioscience* 41: 540-551.
- Groot, C., and L. Margolis, Editors. 1991. *Pacific Salmon Life Histories*. UBC Press, Vancouver, BC. 564 pp.
- Hammer, T.R. 1972. "Stream Channel Enlargement Due to Urbanization." *Water Resources Research* 8(6): 1530-1540.
- Hollis, G.E. 1975. "The Effect of Urbanization on Floods of Different Recurrence Interval." *Water Resources Research* 66: 84-88.
- Horner, R.R., Booth, D.B., Azous, A.A., and May, C.W. 1996. "Watershed Determinants of Ecosystem Functioning." In Roesner, L.A., Editor. *Effects of Watershed Development and Management on Aquatic Ecosystems*. Proceedings of the ASCE Conference, Snowbird, UT.
- Karr, J.R. 1991. "Biological Integrity: A Long-Neglected Aspect of Water Resources Management." *Ecological Applications* 1(1):66-84.
- Klein, R.D. 1979. "Urbanization and Stream Quality Impairment." *Water Resources Bulletin* 15: 948-963.
- Kleindl, W. 1995. *A Benthic Index of Biotic Integrity for Puget Sound Lowland Streams*. Washington, USA. Masters Thesis, University of Washington, Seattle, Washington. 68 pp.
- Leopold, L.B. 1968. *The Hydrologic Effects of Urban Land Use: Hydrology for Urban Land Planning - A Guidebook of the Hydrologic Effects of Urban Land Use*. USGS Circular 554.
- Lucchetti, G. and R. Fuerstenberg. 1993. "Relative Fish Use in Urban and Non-Urban Streams." In: *Proceedings of the Conference on Wild Salmon*. Vancouver, BC.
- Masser, C., R.F. Tarrant, J.M. Trappe, and J.F. Franklin. 1988. *From the Forest to the Sea: A Story of Fallen Trees*. USDA Forest Service. PNW-GTR-229.
- Maxted, J.R., E.L. Dickey, and G.M. Mitchell. 1994. *Habitat Quality of Delaware Nontidal Streams*. Delaware Department of Natural Resources, Division of Water Resources Report.
- May, C.W. 1996. *Assessment of the Cumulative Effects of Urbanization on Small Streams in the Puget Sound Lowland Ecoregion: Implications for Salmonid Resource Management*. Ph.D. Dissertation, University of Washington, Seattle, WA. 222 pp.
- Naiman, R.J., Editor. 1992. *Watershed Management: Balancing Sustainability and Environmental Change*. Chapman and Hall, London, UK. 265 pp.
- Nawa, R.K. and C.A. Frissell. 1993. "Measuring Scour and Fill of Gravel Streambeds with Scour Chains and Sliding-Bead Monitors." *North American Journal of Fisheries Management* 13: 634-639.
- Nehlsen, W., J. Williams, and J. Lichatowich. 1991. "Pacific Salmon at the Crossroads: Stocks at Risk from California, Oregon, Idaho, and Washington." *Fisheries* 16(2): 4-21.
- Pitt, R., R. Field, M. Lalor, and M. Brown. 1995. "Urban Stormwater Toxic Pollutants: Assessment, Sources, and Treatability." *Water Environment Research* 67(3):260-275.
- Plafkin, J.L., M.T. Barbour, K.D. Porter, S.K. Gross, and R.M. Hughes. 1989. *Rapid Bioassessment Protocols for Use in Streams and Rivers: Benthic Macroinvertebrates and Fish*. EPA 440-4-89-001. 164 pp.
- Rankin, E.T. 1989. *The Qualitative Habitat Evaluation Index [QHEI]: Rationale, Methods, and Application*. Ohio EPA, Ecological Assessment Section, Columbus, Ohio. 53 pp.

R0079548

- Schueler, T. 1994. "The Importance of Imperviousness." *Watershed Protection Techniques* 1(3): 100-111.
- Schueler, T. 1995. "The Architecture of Urban Stream Buffers." *Watershed Protection Techniques* 1(4): 155-163.
- Steedman, R.J. 1988. "Modification and Assessment of an Index of Biotic Integrity to Quantify Stream Quality in Southern Ontario." *Canadian Journal of Fisheries and Aquatic Sciences* 45: 492-501.
- Steward, C.R. 1983. *Salmonid Populations in an Urban Stream Environment*. Masters Thesis, University of Washington. Seattle, Washington. 447 pp.
- Wigmosta, M.S., S.J. Burgess, and J.M. Meena. 1994. *Modeling and Monitoring to Predict Spatial and Temporal Hydrologic Characteristics in Small Catchments*. USGS Water Resources Technical Report No. 137. 29 pp.
- Wydzga, A. 1997. *The Effects of Urbanization on Fine Sediment Deposition in Puget Sound Lowland Streams*. Masters Thesis, University of Washington. Seattle, Washington. 80 pp.

Metric to English Conversion Table

Unit	To Convert	Multiply By	To Obtain
Length	km	.621	mi
Length	meters	3.281	ft
Area	km <sup>2</sup>	247.1	acres
Area	km <sup>2</sup>	.386	mi <sup>2</sup>
Proportion	km / km <sup>2</sup>	1.609	mi / mi <sup>2</sup>

R0079549



# Dynamics of Urban Stream Channel Enlargement

2

It is widely accepted that urbanization can alter the geometry and stability of stream channels. Both anecdotal evidence and field research support the notion that the larger and more frequent discharges that accompany watershed development cause downstream channels to enlarge, whether by widening, downcutting, or a combination of both. Channel enlargement severely degrades the quality of instream habitat structure and sharply increases the annual sediment yield from the watershed. These two factors, in turn, are thought to be responsible for the sharp drop in aquatic diversity frequently observed in urban streams (EPA, 1997).

Despite the large body of research available, many questions about the channel enlargement process in urban streams remain to be answered. For example, exactly how much will a channel enlarge, and how many years will it take to do so? Can the degree of enlargement be predicted by watershed indicators, such as impervious cover, age of development, geology or stream gradient? Finally, what stormwater management strategies can engineers use to mitigate the amount of future channel enlargement?

In this article, we review past research on channel enlargement processes in urban streams and explore how long it takes streams to reach a "new" equilibrium once watershed development is completed. These concepts are illustrated with some recent and historical geomorphological data drawn from Watts Branch, an urban stream in the Maryland Piedmont that has been the subject of considerable development and study for more than 40 years.

## Evidence of the Impacts of Watershed Development on Channel Enlargement

The first evidence that stream channels enlarge in response to watershed development can be found in the high bank erosion rates measured for urban streams. In a recent study, bank erosion accounted for an estimated two-thirds of the measured instream sediment load of an urban stream in California (Trimble, 1997). In contrast, most geomorphologists have found that bank erosion in rural streams comprises only 5% and 20% of the annual sediment budget (Walling and Woodward, 1995; Collins *et al.*, 1997). Evidently, channel enlargement can

begin at a relatively low level of watershed development, as indicated by the amount of impervious cover. One study estimated that channel erosion rates were three to six times higher in a moderately urbanized watershed (14% impervious cover) than in a comparable rural one, with less than 2% impervious cover (Neller, 1988).

Further evidence that stream channels enlarge in response to watershed development lies in research studies that have tracked the change in the cross-sectional area of stream channels over time. The simplest way to quantify these changes is to define an "enlargement ratio," which represents the ratio of a stream's current cross-sectional area to its pre-development cross-sectional area (or, in some cases, a cross-section from an adjacent undeveloped stream of equivalent watershed area). The concept of the channel enlargement ratio can be easily grasped by examining past and current stream cross sections in Watts Branch (Figure 1).

Watts Branch was first studied by Luna Leopold and others in the early 1950s, when development first began to spread across what was a predominately rural watershed (less than 3% impervious cover). Since then, the watershed has been gradually, but continuously,

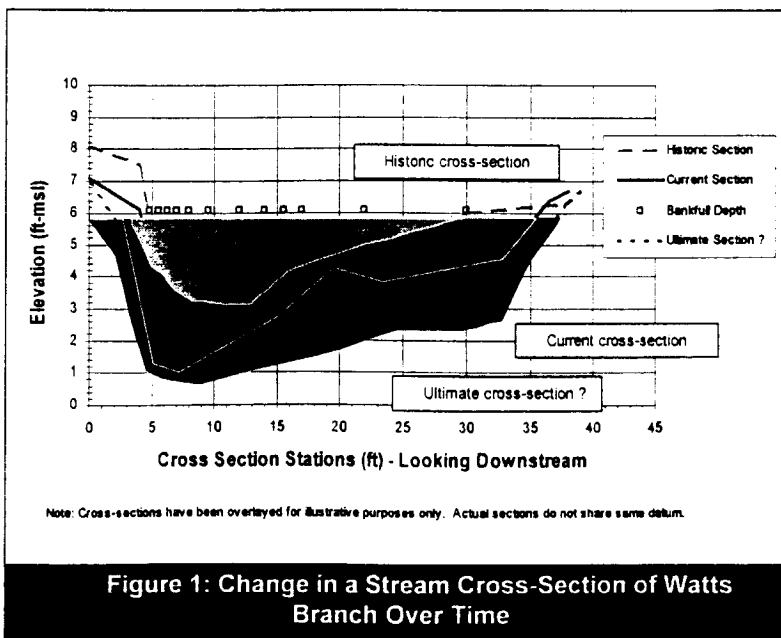

**Figure 1: Change in a Stream Cross-Section of Watts Branch Over Time**

converted to suburban development, with current impervious cover at about 30%. Some indication of the land use conversion can be gleaned from Figure 2, which shows aerial photographs of the watershed taken in 1968 and 1997. Based on current zoning and development trends, the watershed is expected to be fully built out by the year 2005, and has a projected impervious cover of 36%. How has the stream channel changed over time in response to this watershed development?

In 1953, Leopold measured a cross-sectional area of 30.4 square feet for the stream channel reach. By 1999, the same stream channel had enlarged in size to about 70.3 square feet in area, according to Brown and Claytor (2000). Assuming that the 1953 cross-section approximates pre-development conditions, the current enlargement ratio for this stream reach is calculated to be about 2.3. It is interesting to note that this enlargement occurred despite the fact nearly half of the watershed development was built with two-year peak discharge controls. Further, recent rapid channel assessments by Brown and Claytor (2000) indicate that the stream channel has not yet finished the enlargement process, and is ultimately predicted to have an enlargement ratio of 4.4.

#### Can Channel Enlargement be Predicted on the Basis of Impervious Cover?

Other researchers have also noted the tendency of urban stream channels to enlarge in response to relatively low levels of watershed development (Allen and Narramore, 1985; Krug and Goddard, 1986; Murphey and Grissinger, 1985; Neller, 1989; Booth, 1990 and May *et al.*, 1997). Some researchers have demonstrated a direct relationship between channel enlargement and

urban land use in the watershed area. For example, Morisawa and LaFlure (1979) investigated 11 small watersheds near Pittsburgh, PA and Binghamton, NY and found a strong relationship between the watershed urbanization (defined as the fraction of the watershed area that had more than 5% impervious cover) and channel enlargement (Figure 3).

Hammer (1977), working in northern Virginia streams, also found that watershed development had a general influence on channel enlargement, with the greatest factors being impervious cover, the presence of storm sewers and the age of development (see Table 1).

While past research indicates that stream channels do enlarge in response to watershed development, it is not always clear precisely how much enlargement can be expected for a given level of impervious cover, nor what form the new channel will take. For example, Neller (1988) investigated 14 urban streams in South Wales, Australia and discovered that while urban stream channels were 3.8 times larger than comparable rural streams, the amount of impervious cover in a watershed could not precisely predict the degree of enlargement. The lack of a precise relationship was attributed to highly localized factors, such as stream gradient, riparian disturbance and historical channel alteration. Murphey and Grissinger (1985) have observed severe channel enlargement in some rural watersheds with virtually no impervious cover that was caused by channelization, grazing or other human disturbances.

The variability in stream channel enlargement ratios was evident in the Watts Branch watershed. Figure 4 shows current and forecasted channel enlargement in 1999 for 10 stream reaches that had watershed impervi-

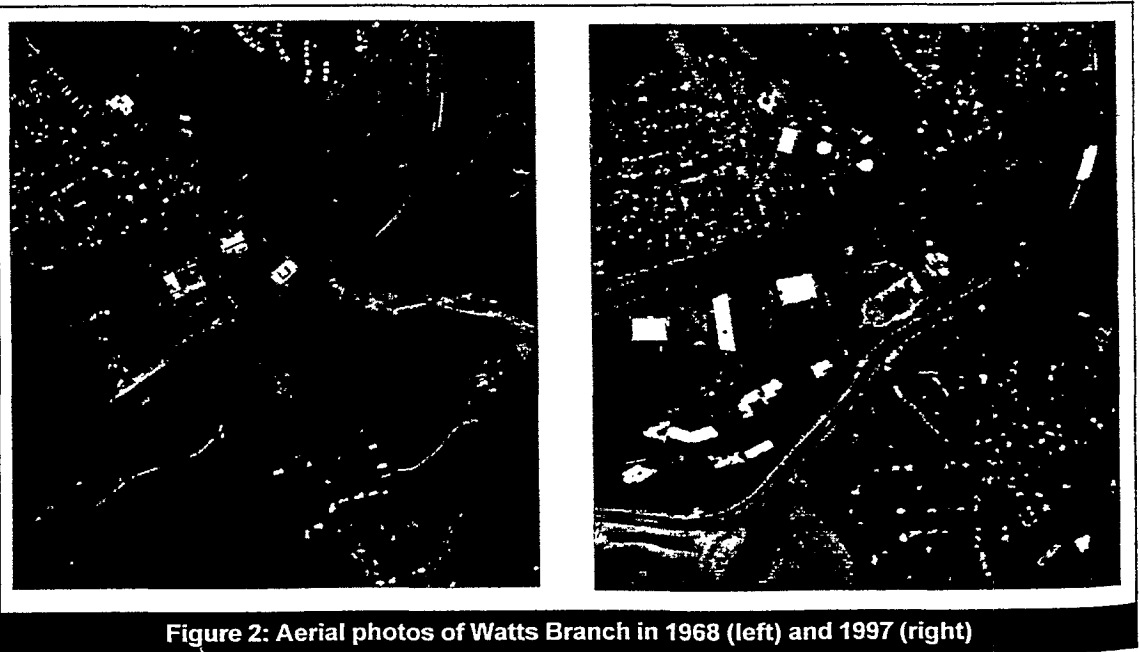

Figure 2: Aerial photos of Watts Branch in 1968 (left) and 1997 (right)

ous cover ranging from 26% to 50%. No clear trend between impervious cover and channel enlargement is evident within this relatively narrow range of impervious cover. While impervious cover influences channel enlargement, it cannot always predict how much will occur. Localized factors, such as stream gradient, age of development, and channel constrictions were thought to play a role in explaining the variance in Watts Branch. For example, if the geology or soils of the streambed and bank materials are highly resistant to erosion, channel enlargement tends to occur at a slower rate. In addition, stream gradient has a strong influence on the rate of enlargement and the new channel form. All other factors being the same, a steep gradient stream tends to enlarge faster than one with a gentle gradient. Finally, artificial constrictions in the stream, such as a bridge or culvert, can dramatically alter cross-sections from reach to reach.

Booth (1990) describes two forms of channel enlargement: *expansion* and *incision*. Channel *expansion* tends to occur gradually, and results in increases in channel width and depth roughly in proportion to the increase in peak flows. *Incision*, on the other hand, is when the stream cuts deeper into its bed, and the increase in channel area can be out of proportion with increases in stream discharge. Booth concludes that the difference between these two modes of erosion can be largely predicted based on the materials in the bed and bank of the stream, as well as the gradient. Similarly, Allen and Narramore (1985) found channel enlargement ratios for urban streams in Texas were 12% and 67% greater for streams with chalk bed materials than those with shale beds.

### How Long Does It Take for Channel Enlargement to Occur?

Watershed managers often ask how long it takes an urban stream channel to reach its ultimate size. The answer appears to be many decades, but can depend on local stream characteristics. To begin with, watershed development does not happen overnight. Development tends to be a gradual but continuous process that

**Table 1: Effects of Different Land Cover Types on Channel Enlargement in a One Square Mile Watershed (Hammer, 1977)**

Land Use	Enlargement Ratio
Cultivated Land	1.29
Woodlands	0.75
Golf Course	2.54
Houses on Sewered Streets <sup>1</sup>	2.19
Sewered Streets <sup>1</sup>	5.95
Other Impervious Area <sup>1,2</sup>	6.79
Pervious Urban Areas <sup>1</sup>	1.08
Open Land	0.9

**Notes:**

- 1: Impervious areas only include areas greater than four years old. Impervious area less than four years old is included with pervious urban areas.
- 2: "Other Impervious Areas" includes commercial areas, and other impervious cover not associated with sewed streets or houses.

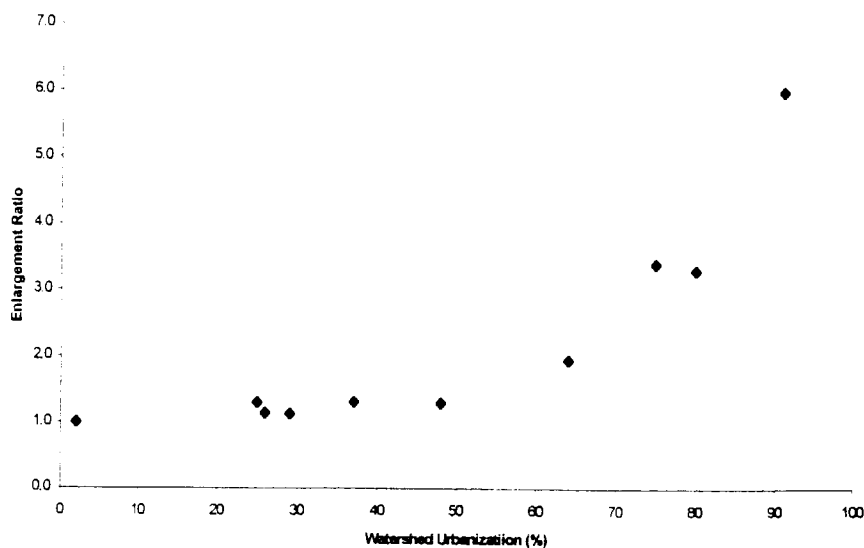

**Figure 3: Influence of Urbanization Channel Enlargement in New York and Pennsylvania (Morisawa and LaFlure, 1979)**

extends over several decades. Consequently, many urbanizing watersheds have yet to reach their ultimate hydrologic condition, let alone their ultimate channel enlargement. Thus, the urban stream channel cross-section we measure now has probably not reached its ultimate size. This is an important fact to keep in mind when interpreting stream geometry data, since current cross-sections may only represent one snapshot in time.

Most past research has acknowledged that time plays a considerable role in the process of channel enlargement. For example, early researchers noted that watershed development less than five years old had little immediate effect on channel enlargement. They observed a "lag time" between when development is first constructed and when streams fully enlarge (Hammer, 1977). Until recently, however, there has been little research to define how long it actually takes for an urban stream channel to reach a new equilibrium, or whether such an equilibrium can ever be achieved.

Craig MacRae and his colleagues have focused on this issue, and have recently developed techniques to predict an "ultimate" enlargement ratio for urban streams. This ratio represents the ultimate enlargement that is projected to occur, given the current level of watershed development, rather than the current degree of channel enlargement measured now.

These effects have resulted in the development of a curve fitting technique used to forecast ultimate channel enlargement for relatively erodible alluvial streams (MacRae and DeAndrea, 1999). Based on these techniques, it is estimated that it may take 50 to 75 years for channel enlargement to be completed once watershed development starts. This analytical method assumes that the enlargement process is predictable, and that an urban

stream will ultimately reach a new equilibrium in response to its altered hydrology.

The MacRae and DeAndrea method utilizes historical and current data on stream cross sections and land use. Historic cross-sections are obtained from many sources including prior geomorphological research, engineering surveys or flood plain modeling. Current and historic impervious cover are derived from low altitude aerial photographs taken at different intervals through the urbanization process (e.g., Figure 2). Using a basic hydraulic model, these data are used to characterize the pre-development and current channel cross-sections, and predict the ultimate channel cross-sections. An ultimate enlargement curve for 60 channel reaches of alluvial streams in Texas, Maryland and Vermont is presented in Figure 5. A regression line shows the "best fit" through the data which provides watershed managers a rough sense of how much channel enlargement can be expected for different levels of impervious cover. It should be noted that this general curve does not apply to stream channels with a rock bed or rock banks.

#### Can We Prevent Channel Enlargement?

Past efforts to control channel erosion through stormwater management have been largely unsuccessful. The root of this failure appears to be a misinterpretation of past geomorphological research. Engineers reasoned that if natural channels are largely formed by "bankfull" storm events that occur on average once every one or two years (Leopold *et al.*, 1964), then stormwater ponds should detain the post development peak discharge for the two-year storm to its pre-development level (i.e., two year storm control). There are two problems with this approach. First, while the magnitude of the peak discharge may not change from pre- to post-development with two-year control, the duration of erosive flows sharply increases. Second, the bankfull event shifts to rainfall events smaller than the two-year return frequency. Consequently, the total energy available to transport bed materials can actually increase when two-year peak discharge control is used.

The choice of two-year storm control neglects this increased frequency of bankfull and sub bankfull flows in urban watersheds. For example, Leopold (1994) observed that the average number of bankfull flow events in Watts Branch increased from two to seven times per year between 1958 and 1987, and is expected to increase slightly in the coming years due to more recent watershed development. Regrettably, two-year peak discharge control cannot reduce the frequency or duration of these channel-forming and channel enlarging events.

Engineers have several options that can guard against future channel enlargement. The first option is to design ponds to detain a greater range of storm events, considering the characteristics of bed and bank

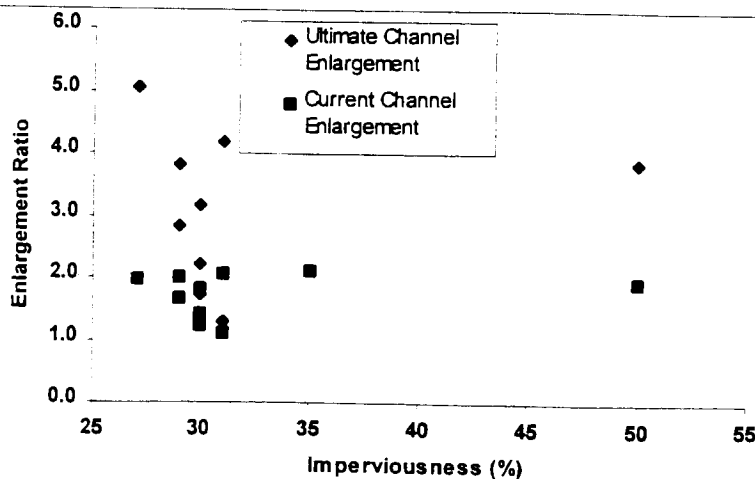

Figure 4: Current and Forecasted Channel Enlargement in 1999 for 10 Stream Reaches With Impervious Cover Ranging From 26% to 50%

materials at a downstream control section (MacRae, 1991). The objective is to minimize the alteration in the transverse distribution of erosion potential about a channel parameter, over the range of available flows, such that the channel is just able to move the dominant particle size of the bed load. The drawback of this method is that it requires complex field assessments and sophisticated modeling to determine the hydraulic stress and erosion potential of bank materials at each development site.

A second and more simple option is to establish a single channel protection criterion for all development sites that detain smaller runoff events that can cause channel enlargement. A notable example is Maryland, which recently adopted a requirement that dispenses with two-year peak discharge control and replaces it with 24-hour detention of the one-year storm (MDE, 2000). For most parts of the state, a three-inch storm must be detained for 24 hours, which also results in at least six hours of detention of smaller storms (one to two inches). The basic premise of this approach is that runoff will be stored and released from a pond in such a gradual manner that critical erosive velocities will seldom be exceeded in downstream channels, over a wide range and frequency of channel-forming events. The required storage volume needed for 24-hour detention of the one-year storm is not trivial; it is roughly comparable to the storage volume for 10-year peak discharge control. More stream research is needed to determine how well this criterion can prevent the channel enlargement process.

### Implications of Channel Enlargement for Watershed Managers

While it is not always easy to predict the absolute degree of channel enlargement caused by watershed development, it is clear that enlargement will occur in the absence of sophisticated stormwater controls. What other implication does channel enlargement have for the watershed manager? First, the notion that channels can enlarge by as much as a factor of 10 is yet another convincing argument to establish wide stream buffers in communities. The existence of a buffer puts some distance between the landowner and the growing stream, and helps to reduce future complaints about bank erosion and backyard flooding that are an inevitable consequence of watershed development. Second, channel enlargement has great implications for urban stream restoration practitioners, who need to base their designs on future enlargement rather than just current stream cross-section. Designers that fail to appreciate this difference are likely to see many of their practices wash out, undercut or otherwise fail as the channel increases in size. It also underscores the need to install upstream stormwater retrofits to arrest the channel enlargement process at downstream urban stream restoration projects.

Third, engineers need to plan for ultimate channel enlargement when locating infrastructure in or around a stream, whether they are a planning a culvert, sewer, bridge or pipeline. This planning is not only needed to protect infrastructure from damage, but also to prevent the infrastructure from becoming a barrier to fish migration in the future. Lastly, stormwater managers need to develop and assess stormwater design criteria that

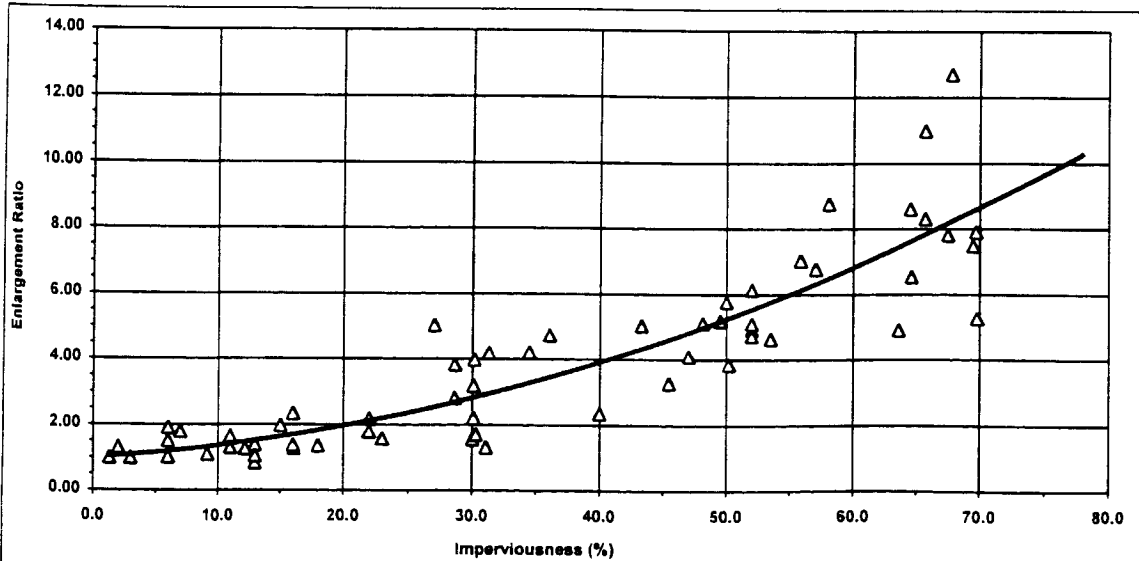

Figure 5: "Ultimate" Channel Enlargement as a Function of Impervious Cover in Alluvial Streams in Maryland, Vermont and Texas (MacRae and DeAndrea, 1999; and Brown and Claytor, 2000)

directly address the channel enlargement problem. Until these channel protection criteria are more widely adopted, stormwater managers will have great difficulty in maintaining downstream habitat and aquatic diversity. -DSC

#### References

- Allen, P. and R. Narramore. 1985. "Bedrock Controls on Stream Channel Enlargement With Urbanization, North Central Texas." *Water Resources Bulletin*. 21(6): 1037-1048.
- Booth, D. 1990. "Stream Channel Incision Following Drainage Basin Urbanization." *Water Resources Bulletin*. 26(3): 407-417.
- Brown, E. and R. Claytor. 2000. *Draft Watershed Assessment Study for Watts Branch*. Watts Branch Watershed Plan. City of Rockville, MD. Center for Watershed Protection. Ellicott City, MD.
- Collins, A. D. Walling, and G. Leeks. 1997. "Source Type Ascription for Fluvial Suspended Sediment Based on a Quantitative Composite Fingerprinting Technique." *Catena* 29:1-27
- Hammer, T. 1977. "Stream Channel Enlargement Due to Urbanization." *Water Resources Research*. 8(6): 1530-1540.
- Krug, W. and G. Goddard. 1986. "Effects of Urbanization on Streamflow, Sediment loads, and Channel Morphology in Pleasant Branch Basin Near Middleton, Wisconsin." *USGS Water Resources Investigations Report 85-4068*.
- Leopold, L. 1994. *A View of the River*. Harvard University Press. Cambridge, MA. 298 pp.
- Leopold, L., M. Wolman, and J. Miller. 1964. *Fluvial Processes in Geomorphology*. W. H. Freeman and Company. San Francisco, CA. 522 pp.
- MacRae, C. 1991. *A Procedure for the Planning of Storage Facilities for Control of Erosion Potential in Urban Creeks*. Ph.D. Thesis. Department of Civil Engineering. University of Ottawa.
- MacRae, C. and M. DeAndrea. 1999. *Assessing the Impact of Urbanization on Channel Morphology*. 2<sup>nd</sup> International Conference on Natural Channel Systems. Niagra Falls, Ontario. 1999.
- Maryland Department of the Environment (MDE). 2000. *Maryland Stormwater Design Manual*. Volume One. Baltimore, MD.
- May, C., R. Horner, J. Karr, B. Mar and E. Welch. 1997. "Effects of Urbanization on Small Streams in the Puget Sound Lowland Ecoregion." *Watershed Protection Techniques* 2(4):483-492.
- McCuen, R. and G. Moglen. 1988. "Multicriterion Stormwater Management Methods." *Journal of Water Resources Planning and Management*. 114(4): 414-431.
- Morisawa, M. and E. LaFlure. 1979. "Hydraulic Geometry, Stream Channel Equilibrium and Urbanization." *Adjustments of the Fluvial System*. 10<sup>th</sup> Geomorphology Symposium. Binghamton, NY. pp. 333-350.
- Murphey, J. and E. Grissinger. 1985. "Channel Cross-Section Changes in Mississippi's Goodwin Creek." *Journal of Soil and Water Conservation*. 46(1): 148-153.
- Neller, R. 1988. "A Comparison of Channel Erosion in Small Urban and Rural Catchments, Armidale, New South Wales." *Earth Surface Processes and Landforms*. 13(1): 1-7
- Neller, R. 1989. "Induced Channel Enlargement in Small Urban Catchments, Armidale, New South Wales." *Environmental Geology and Water Sciences*. 14(3): 167-171
- Trimble, S. 1997. "Contribution of Stream Channel Erosion to Sediment Yield From an Urbanizing Watershed." *Science*. 278: 1442-1444.
- U.S. EPA. 1997. *Urbanization and Streams: Studies of Hydrologic Impacts*. Office of Water. Washington, D.C. 841-R-97-009.
- Walling, D. and J. Woodward. 1995. "Tracing Sources of Suspended Sediment in River Basins: A Case Study of the River Culm, Devon, UK." *Marine and Freshwater Research*. 46: 324-336.

# Stream Channel Geometry Used to Assess Land Use Impacts in the Northwest

**M**any urban watershed programs fail to fully consider the implications of past, present, or future geometry of the stream system. In many instances, historical data can be used to correlate stream geometry with land use changes and watershed protection efforts. Results from efforts in other watersheds can be extrapolated to predict changes in similar stream systems. As discovered in the Pacific Northwest, the effectiveness of earlier stormwater treatment practices can be assessed by examining current stream channel stability. The observed alterations to stream channel geometry can be linked to changes in land use patterns and, therefore, can provide practical guidelines for predicting and preventing degradation in similar stream systems.

Once a minimum level of watershed imperviousness is exceeded, stream systems begin to exhibit quantifiable impacts to water quality, biological, and physical condition (Schueler, 1994). Booth and Reinelt (1993) found that 10 to 15% effective impervious cover can lead to noticeable changes in channel morphology, biological populations, vegetative succession, and water chemistry in streams and wetlands in western Washington state. Generally, an increase in impervious cover increases the volume of runoff associated with precipitation events of all magnitudes (Hollis, 1975). Consequently, the frequency of occurrence of mid-bankfull flow events also increases with increasing imperviousness. Mid-bankfull flow events have been found to be geomorphically significant in terms of their capacity to transport sediment and form the stream channel (Harvey *et al.*, 1979; MacRae and Rowney, 1992). Ultimately, stream geometry, and hence stability, are adversely affected by these events.

The hydrological impacts associated with increased watershed imperviousness may lead to catastrophic channel expansion or channel incision as the stream channel attempts to reestablish equilibrium. The impacts of stream geometry changes can be severe and occur over long periods of time. Eventually, eroding channels destroy habitat diversity and clog downstream systems. Table 1 summarizes the physical characteristics that make stream reaches susceptible to destabilizing erosion in the Pacific Northwest. One early indicator of a destabilizing channel is when sediment transport changes within the channel itself. Sediment transport is a function of shear stress and the resistance of bottom sediments to movement (Booth,

1990). Sediment transport is directly proportional to slope and inversely proportional to grain size, respectively.

A second indicator of stream erosion susceptibility is the presence of large woody debris (LWD) in the channel, such as trees limbs. LWD adds an external and transitory component of roughness to the stream channel. The increased roughness allows a stable channel to evolve, albeit at a gradient significantly steeper than resistance to sediment transport alone would support (Keller and Swanson, 1979). The channel rapidly incises, lowering the stream bed as the stream attempts to reach equilibrium by reducing the overall channel gradient. The LWD is then stranded above the low flow path. If the bed lowering significantly reduces the overall gradient, the stream incision may potentially be alleviated or halted because much of the total shear stress is dissipated on non-erodible material (i.e., the LWD). However, if the overall gradient is not significantly reduced, incision will be much more difficult to halt (Booth, 1990).

Unfortunately, these generalizations do not specifically reveal how any single stream would respond to land use changes and the timetable over which those responses would occur. This is due to specific physical conditions that differ from stream to stream. Booth (1994) established a protocol for evaluating physical stream channel condition impacts that have resulted from development. The protocol is relatively simple, requires little equipment, and can be implemented using a two-member team. An overview of the protocol is presented in Table 2. Specifically designed for regions with steeper slopes, some adaptation is needed to make Booth's protocol applicable to other areas, such as humid coastal zones and the arid Southwest. In addition, all steps may not apply to certain water bodies; for example, bankfull width and depth measurements are not always practical for large rivers.

**Table 1: Characteristics of Erosion-Susceptible Stream Reaches**

1. Low-order, high gradient streams
2. Fine-grained, noncohesive geologic deposits
3. Low infiltration capacities of upland soils
4. Channel form and gradient controlled by large organic debris

**Table 2: Overview of Rapid Channel Assessment Protocol**

The protocol is intended to evaluate current stream channel conditions and not susceptibility to future disturbance.

**Personnel/Equipment:** two people; hip chain, 50' tape, wading rod, notebooks, clinometer

**Procedure:** Define a channel reach of approximately 2000'. Use a hip chain to measure out channel segments of equal length of about 10-20 channel widths each (typically 100'-200'). Within each segment:

- Determine single representative values for bankfull width and depth (with or without a measured and monumented cross section), percent of channel-bank scour (and/or artificial armoring), and sediment-size distribution.
- Keep a running total of the number of large woody debris pieces within the bankfull channel.
- Generate a thalweg profile in the vicinity of all large pools.

2

**Rapid Channel Assessment Protocol**

The protocol is applied to representative channel reaches approximately 2,000 feet in length. The reach is subdivided into segments of equal length of about 10 to 20 channel widths. The protocol is applied to each segment, focusing on representative physical measurements, large woody debris, and thalweg profiles.

*Representative Measurements*

Bankfull width and depth

Representative dimensions of the active channel are measured first. Bankfull width and depth are indicated by change in slope at top of bank, lower limits of perennial vegetation, and/or height of active scour (Williams, 1978). In any channel segment where the reach is incised or this measurement is otherwise not possible, it should be omitted.

Channel cross-section

The representative measurements may not always yield sufficient data for tracking channel changes. When additional detail is required, several channel cross-sections should be measured. The cross-sections should be taken at representative channel location(s), normally in straight reaches without prominent pools and with alluvial (i.e. loose water-transported) sediment on the bed and banks. The cross-section locations should be permanently marked (monumented). Rebar can be driven into the floodplain at a location several feet back from both channel edges and the top of rebar and nearby trees should be flagged to make stations easier to find.

The two-member team measures the cross-section, stretching a 50 foot tape level across the channel from the left-bank rebar (looking downstream) to the right. One person moves along the tape at one-foot intervals, reading off horizontal distance and depth from tape to channel bed. The second person maintains tape tension and records data. The bankfull depth and width are also estimated and the hip-chain distance of the cross section is noted.

Percent channel-bank scour

In each 100 to 200-foot channel segment, both stream banks are scored using the following categories:

<u>Score</u>	<u>Category</u>	<u>Description</u>
1.0	Stable	Vegetated or low bars to level of low flow
2.0	Low scour	Steep, raw banks only below bankfull level
3.0	Full scour	Steep, raw banks above bankfull level
4.0	Armored	Artificial bank protection of any kind

Each person tracks the scour of one bank, noting the hip-chain distance at each change of category; category changes less than 10 feet are usually ignored. Each segment is given a single length-weighted score (e.g. one bank fully "Stable" and one bank fully at "Low Scour" yields an aggregate score of 1.5).

Sediment size distribution and embeddedness

At one or more sites in each segment, 100 substrate samples known as *clasts* are counted in the streambed using the "first-touch" technique of Wolman (1954), paying particular attention to sediments in the "less than 4 mm" category (matrix sediment). Sampling is conducted at consistent morphologic locations in the stream, ideally in channel-spanning riffles midway between alternate meanders (small streams) or midway between the apex and upstream end of point bars (large rivers). Channel cross-sections should coincide with the site of pebble counts.

*Large Organic Debris*

The second set of measurements focus on organic debris, specifically on large woody debris (LWD) pieces. In each channel segment, running LWD totals are tallied. To qualify for data collection, LWD must (1) be a minimum of four inches in diameter and three feet long, (2) be in contact with the flow at the bankfull discharge.



(3) be not easily dislodged from position, and (4) show some influence on channel-bed topography or sediment sorting. Where a debris jam is present, the minimum number of pieces necessary to maintain the jam (the "framework" pieces) should be estimated.

#### Thalweg Profiles

The final protocol step focuses on large pools. Within each channel segment, pools with a downstream length at least as great as the average bankfull channel width ( $w_{bf}$ ) of the entire channel reach are counted. Water depths within these pools are measured with a wading rod at maximum spacing of  $0.25 w_{bf}$  for subsequent plotting and volume estimation using the "Rapid Streambed Profile" of Stack and Beschta (1989) and Robinson and Kaufman (1994).

Flow control in urbanizing basins, especially in areas with steeper slopes and fine-grained substrates, is a critical factor in protecting stream channels. To be fully effective, detention volumes should be sufficient to match both peaks and durations for pre- and post-development conditions typical of at least the two-year event, and possible even lower discharges (MacRae 1993). These detention volumes often exceed typical municipal requirements by an order of magnitude. Given the high additional cost and space requirements for these larger facilities, this underscores the importance of recognizing erosion-susceptible terrain (Table 1). Where development impacts are anticipated, adequate detention, extensive upland buffers, and perhaps flow diversion may be used to reduce channel impacts.

Although it is a descriptive rather than predictive approach, Booth's methodology can potentially be used to correlate impacts to physical stream conditions with upstream development or land use changes. To effectively do so, however, subwatershed land use conditions and impervious cover must be recorded over time. It is not always possible to directly correlate physical stream conditions to various levels of imperviousness. The type of noticeable, large-scale stream stability changes considered in Booth's protocol may lag development by several decades or more, and may not be immediately evident during the early stages of urbanization.

These considerations do not diminish the particular usefulness of Booth's protocol. This protocol provides a simple, repeatable method to monitor the effectiveness of stormwater quantity controls with respect to hydrology and channel stability. This information can provide insight into a watershed's development capacity, the types of stormwater treatment practices needed, and where practices are most useful for protecting stream stability. When used in conjunction with other stream assessment techniques such as EPA's Rapid Bioassessment Protocol (Plafkin *et al.*, 1989) and Galli's Rapid Stream Assessment Technique (1996), Booth's protocol can provide insight to how currently un-

impacted streams of similar size and morphology might respond to different development intensities. An understanding of morphological responses, then, can be used to design protection strategies for these relatively untouched streams. Early modeling and field research has shown that Booth's method is a robust predictor of stream erosion potential in the Pacific Northwest.

-RLO

#### References

- Booth, D.B. 1990. "Stream-Channel Incision Following Drainage-Basin Urbanization." *Water Resources Bulletin* 26(3): 407-417. American Water Res. Assoc.
- Booth, D. 1994. *A Protocol for Rapid Channel Assessment*. unpubl. paper.
- Booth, D.B. and L.E. Reinelt. 1993. "Consequences of Urbanization on Aquatic Systems—Measured Effects, Degradation Thresholds, and Corrective Strategies." In conf. proc.: *Watershed '93 A Nat. Conference on Watershed Mgt.* Mar. 21-24, 1993. Alexandria, VA.
- Galli, J. 1996. Rapid Stream Assessment Technique (RSAT). unpubl. paper. Available through the Metropolitan Washington COGs: 777 North Capitol Street, NE, Washington, DC 20002.
- Harvey, A. M. *et al.* 1979. "Event Frequency and Morphological Adjustment of Fluvial Systems in Upland Britain." In conf. proc. *10th Annual Geomorphology Symposia Series*. September 21 - 22, 1979. Binghamton, NY.
- Keller, E.A. and F.J. Swanson. 1979. "Effects of Large Organic Material on Channel Form and Alluvial Process." *Earth Surface Processes*. 4:361-380.
- MacRae, C. R. 1993. "An Alternative Design Approach for the Control of Instream Erosion Potential in Urbanizing Watersheds." In conf. proc. *Sixth International Conference on Urban Storm Drainage*. September 12-17, 1993. Niagra Falls, Ontario.
- Plafkin *et al.* 1989. *Rapid Bioassessment Protocols for Use in Streams and Rivers: Benthic Macroinvertebrates and Fish*. U.S. EPA, Office of Water, Washington, DC. EPA/330/4-39-001.
- Robinson, E.G. and P.R. Kaufman. 1994. "Evaluating Two Objective Techniques to Define Pools in Small Streams." In: *Effects of Human-Induced Changes in Hydrologic Systems*. Summer Symposium. American Water Resources Association. Jackson Hole, WY. pp. 659-668.
- Schueler, T.R. 1994. "The Importance of Imperviousness." *Watershed Protection Techniques*. 1(3): 100-111.
- Stack, W.R. and R.L. Beschta. 1989. "Factors Influencing Pool Morphology in Oregon Coastal Streams." In: Woesner, W.W. and D.F. Potts (eds), *Symposium on Headwater Hydrology*. American Water Resources Association. pp. 401-411.
- Williams, G.P. 1978. "Bankfull Discharge of Rivers." *Water Resources Research* 14: 1141-1154.
- Wolman, M.G. 1954. "A Method of Sampling Coarse Bed Material." *Transactions of the American Geophysical Union* 35: 951-956.

## Article 21

Technical Note #72 from *Watershed Protection Techniques 2(2): 358-360*

# Habitat and Biological Impairment In Delaware Headwater Streams

2

**A**s part of a comprehensive watershed management demonstration study, John Maxted and his colleagues at Delaware's Department of Natural Resources and Environmental Control (DNREC) examined the effects of urban stormwater runoff on non-tidal headwater streams in Delaware's Coastal Plain and Piedmont ecoregions using a variety of biological and physical habitat assessments. Maxted and his colleagues selected headwater streams for three primary reasons. First, headwater streams are arguably the narrowest window receiving urban stormwater runoff and are not usually exposed to impacts from other sources (i.e., industrial or sewage treatment plant discharges). Second, the biological and physical habitat characteristics of headwater streams are reasonably well understood and amply documented in the literature. Third, most non-tidal waterway systems are made up of headwater streams. So targeted protection and restoration of these sensitive water resources will, by default, provide a level of protection to downstream watershed resources.

Biological and habitat monitoring methods were selected over more traditional chemical monitoring due to the intermittent and varied nature of stormwater runoff. Unlike steady-state flows, used in the analysis of point-source discharges, stormwater events range in frequency, duration, and magnitude and produce var-

ied, and often statistically random, responses of pollutant concentrations. Furthermore, although the states and U.S. EPA have developed pollutant concentration criteria for many pollutants, there are no criteria for many of the most common stormwater pollutants. Therefore, chemical constituent monitoring may yield results of little practical use due to the absence of a standard. In fact, Delaware's 1994 305(b) Report indicated that 87% of the State's non-tidal streams supported the designated life uses based on chemical measures (primarily dissolved oxygen exceedance criteria); whereas if biological and habitat assessments were included, just the opposite was true, and only 13% of the state's non-tidal waters supported designated life uses. This same phenomena was observed by Ohio EPA in 1991 where approximately 50% of that State's waters were identified as impaired when using biological assessments versus approximately 3% when using chemical monitoring alone (Rankin, 1991).

Biological monitoring was conducted using macroinvertebrates as indicators of stream system quality at 42 Coastal Plain sites and 38 Piedmont sites. Macroinvertebrates have varying life stages from a few months to several years, are relatively immobile, and are therefore good tools for assessing both long term and short term impacts in streams. The following three biological measurements were conducted to quantify

**Table 1: Macroinvertebrate Community Measurements Used by Delaware Dept of Natural Resource and Environmental Control (Shaver *et al.*, 1995)**

Metric Name	Description	Type
Taxa richness	Total # of unique taxa	Richness
EPT richness*	Total # of EPT taxa	Richness/tolerance
% EPT abundance	% of sample that are EPTs	Tolerance/composition
% dominant taxon	Largest % of a single taxon	Composition
%Chironomidae**	% of sample from this group	Tolerance
Biotic index	Composite tolerance by taxon	Tolerance

\* EPT consists of the orders ephemeroptera (mayflies), plecoptera (stoneflies), and trichoptera (caddisflies) (considered among the most pollutant sensitive macroinvertebrate species)

\*\* Chironomidae consists of the family of midges (considered among the most pollutant tolerant macroinvertebrate species)

**Table 2: Results of Biological Assessment using Selected Macroinvertebrate Data from the Coastal Plain and Piedmont Ecoregions (Shaver et al., 1995)**  
Sensitivity of Biological Metrics by Condition and Ecoregion (mean values at genus level)

Ecoregion/ Condition	# of Sites	TR	EPT	%EPT	%Midge	%DT
<i>Coastal Plain</i>						
Good	22	29	8	36.5	24.6	21.9
Fair	17	25	4	16.1	29.1	25.1
Poor	3	20	2	3.0	79.9	30.4
<i>Piedmont</i>						
Good	13	23	10	67.8	9.1	32.2
Fair	19	21	5	322.2	20.5	24.6
Poor	6	17	3	15.1	32.8	35.9

TR = Taxonomic richness; EPT = EPT richness; %EPT = Percent EPT abundance; %Midge = Percent chironomidai;  
% DT = Percent dominant taxon

the condition of the macroinvertebrate communities based on the principals of EPA's Rapid Bioassessment Protocols (Plafkin, 1989):

- Species richness or diversity measures in terms of total number and redundancy of unique taxa
- Community tolerance measures in terms of which organisms are indicators of polluted conditions versus high quality and stable conditions
- Composition measurements in terms of the structural makeup of the community

The measurements used to evaluate the macroinvertebrate community are identified in Table 1. Table 2 illustrates the results of the biological monitoring conducted in the Coastal Plain and Piedmont. The data revealed that sites rated as biologically "poor" had reduced total diversity, reduced diversity and abundance of sensitive species, increased abundance of organisms considered pollutant tolerant, and reduced community composition.

Physical habitat measurements were also conducted for both the Coastal Plain and Piedmont ecoregions using various parameters. These measures included assessments in the following four broad areas: general characteristics, instream measures, stream bank measures, and riparian zone measures. The specific type of measures are shown in Table 3. Physical habitat scores designating "poor" habitat conditions were those that lacked stable submerged habitats, had eroded and unvegetated banks, and had impacted floodplains or riparian zones.

Maxted's team also conducted a paired analysis of biological and habitat conditions. Macroinvertebrates

and habitat data were collected at 40 sites in the highly urbanized, Northern Piedmont ecoregion of Delaware. The results, as illustrated in Figure 1, support a direct correlation between habitat quality and biological quality and indicate that the majority of non-tidal streams studied are biologically degraded. The results further suggest that the leading contributor to habitat degradation is urban runoff.

The final element of the monitoring study supports the now well documented assertion that, as the level of watershed imperviousness exceeds certain thresholds, biological community degradation occurs. A preliminary analysis of 19 sites (again in the Delaware Northern Piedmont) showed biological quality impairments occurring between eight and 15% imperviousness. The results also suggest that additional research is needed to examine whether or not the use of stormwater treatment practices can push this degradation threshold to a point where healthy biological communities can be supported with higher levels of imperviousness (see Figure 2). Obviously, this important question is one that needs to be answered to help assess the success of stormwater management programs.

Maxted's approach is clearly an adaptable, cost effective application of a biologically based monitoring effort which assesses levels of aquatic degradation, and helps identify the causes and sources of these impacts. This same protocol, or other similar methods can be repeated in other regions and climates with only minor adaptations.

-RAC

R0079560

**Table 3: Measures Used to Assess Habitat Quality (Shaver et al., 1995)**

Northern Piedmont Ecoregion	Area of Assessment	Coastal Plain Ecoregion	Area of Assessment
Channel modification	General	Channel modification	General
Instream habitat	Instream	Instream habitat	Instream
Bank stability	Streambank	Bank stability	Streambank
Bank vegetative type	Streambank	Bank vegetative type	Streambank
Shading	Riparian	Shading	Riparian
Riparian zone width	Riparian	Riparian zone width	Riparian
Velocity/depth ratio	General	Pools	Instream
Sediment deposition	Instream		
Embeddedness	Instream		
Riffle quality	Instream		
Riffle quantity	Instream		

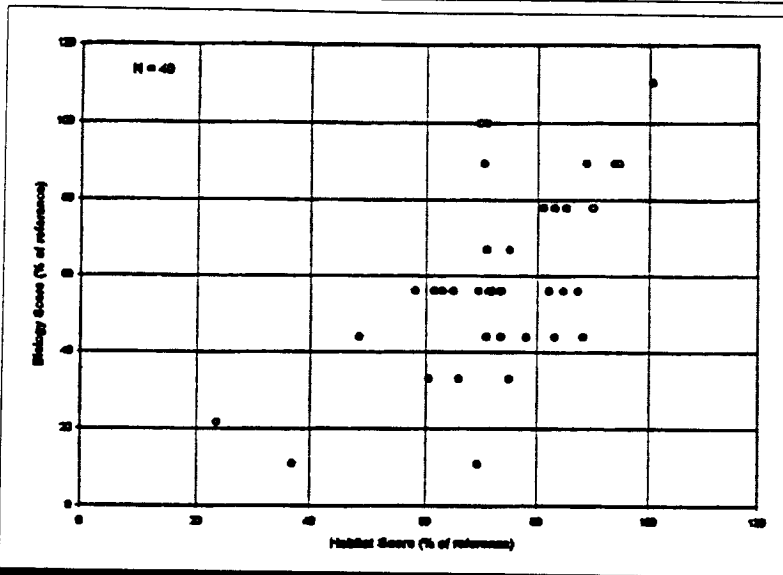

**Figure 1: Relationship Between Habitat and Biological Quality in Delaware's Piedmont Ecoregion**

**References**

Plafkin et al., 1989. *Rapid Bioassessment Protocols for Use in Streams and Rivers: Benthic Macroinvertebrates and Fish*. Environ. Protection Agency, Office of Water. Washington, DC. EPA/440/4-39-001.

Rankin, E.T., 1991. *The Use of Biocriteria in the Assessment of Nonpoint and Habitat Impacts in Warm Water Streams*. Ohio, EPA. Columbus, Ohio.

Shaver, E., J. Maxted, G. Curtis, D. Carter. 1995. "Watershed Protection Using an Integrated Approach." *Proceedings from Stormwater NPDES Related Monitoring Needs*. Mount Crested Butte, Colorado. August 7-12, 1994. Am. Society of Civil Engineers.

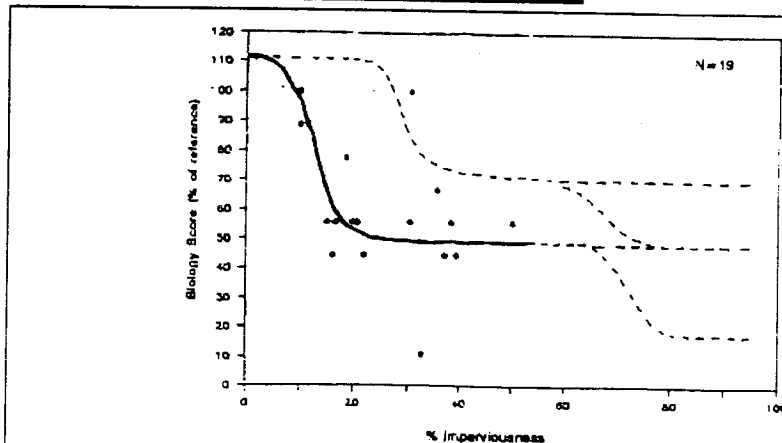

Dashed line shows potential curve shift using stormwater practices and assuming stream protection measures.

**Figure 2: Effect of Watershed Imperviousness on Biologic Integrity Within the Northern Piedmont Ecoregion of Delaware, 1993 (Shaver et al., 1995)**

# Comparison of Forest, Urban and Agricultural Streams in North Carolina

Recent stream research has frequently demonstrated that stream quality indicators decline from baseline conditions as impervious cover in the contributing watersheds increases. The baseline for measuring this decline is usually a non-urban reference watershed. Although it is often impossible to find a totally undisturbed watershed, most studies have used watersheds that are mostly forested and are not actively disturbed as a reference.

Some argue, however, that a forested watershed is not the best baseline to measure changes in stream quality indicators for many regions of the country. This is due to the fact that prior land use in many urbanizing watersheds is often dominated by agriculture and not forest. The choice of a reference land use can have important implications for urban watershed managers. Will the same dramatic decline in stream quality indicators occur if an agricultural watershed is converted into a suburban one? Or have agricultural activities already degraded or impaired stream quality so that little if any decline is noted?

There are a number of good reasons to suspect that agriculture can degrade stream quality. Agricultural areas, for example, produce more runoff, greater soil erosion and higher nutrient loads than forested watersheds. In addition, current or past agricultural practices often modify natural drainage patterns, alter the riparian zone and drain wetlands. On the other hand, agricultural watersheds have little or no impervious cover, and produce only a fraction of the destructive storm flows of an urban watershed. Where, then, do agricultural watersheds fit in?

A paired watershed study conducted by Crawford and Lenat (1989) sheds some light on this issue. The investigators intensively monitored three small watersheds in the North Carolina piedmont over a two-year period (Figure 1). The dominant land uses in each watershed were forest, agriculture and urban, respectively. Riparian condition was generally good in all three watersheds, and point sources were not a factor. Other key watershed characteristics are compared in Table 1.

In each watershed, Crawford and Lenat sampled suspended sediments, water quality, bottom sediments, macroinvertebrates and fish populations. At each study site, instantaneous suspended sediment discharge was statistically correlated with stream discharge. Annual suspended sediment loads were then calculated using

daily discharge values. In addition, the particle size distribution and sediment chemistry of stream substrates were sampled at randomly selected intervals in each stream.

### Findings: Water Quality and Stream Substrate

The three watersheds had contrasting water quality and substrate conditions (Table 2). Sharp differences, for example, were noted in their nutrient levels. The agricultural stream had the highest phosphorus and nitrogen concentrations, whereas nutrients were present at low and possibly limiting levels in the forested stream. The urban streams had an intermediate level of nutrients, but did exhibit the highest level of dissolved nitrogen. With respect to stream temperature, the forested stream was the coolest, whereas the urban stream was the warmest.

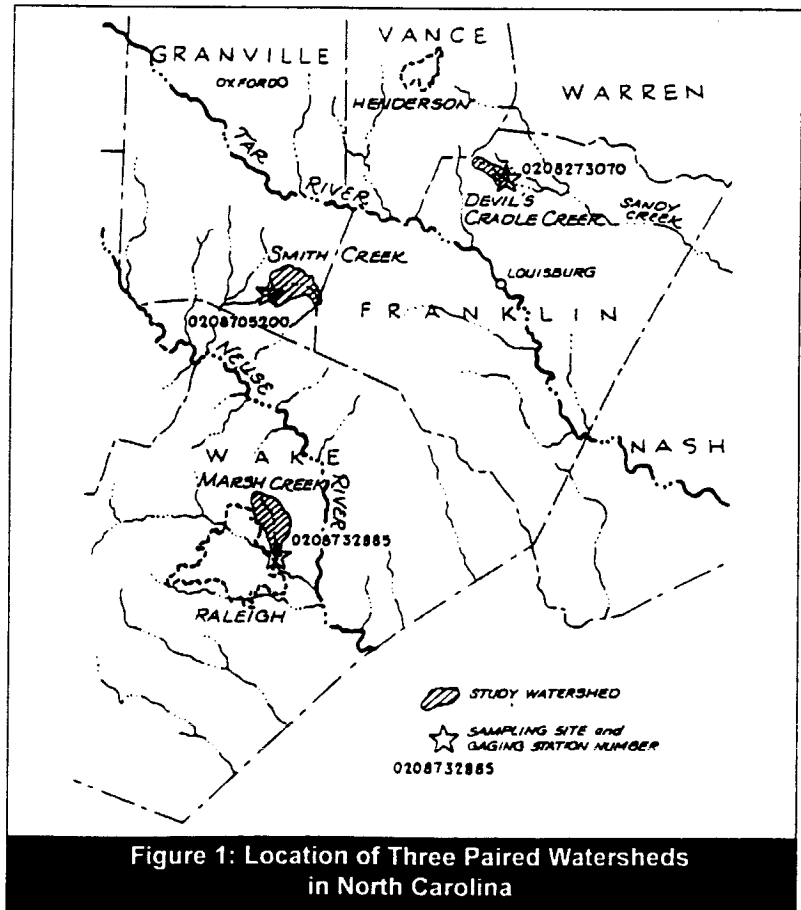

Figure 1: Location of Three Paired Watersheds in North Carolina

2

**Table 1: Comparison of Watershed Characteristics in North Carolina Watershed Study**

Characteristic	Forest Watershed	Agriculture Watershed	Urban Watershed
Name	Smith Creek	Devil's Cradle Creek	Marsh Creek
Area (square miles)	6.2	2.9	6.8
Forest Cover	75%	31%	24%
Agricultural Cover	21%	53%	5%
Urban Cover	4%	13%	71%
Riparian Cover	forested	mostly forested	mostly forested
Stream Order	Second	Second	Third
Point Sources?	None	None	None
Other Influences	upstream beaver dam may have trapped sediment	no stormwater practices were used to treat agricultural runoff	no stormwater practices were used to treat stormwater runoff

The three streams also sharply differed in their annual suspended sediment load. As might be expected, the forested stream had the lowest annual sediment loading (0.13 tons/acre/year, see Table 2). The agricultural stream exported about 2.5 times more suspended sediment than the forested stream, while the urban stream discharged more than four times as much (0.59 tons/acre/year). Soil erosion appeared to be the major source of sediment in the agricultural watershed, while streambank erosion was a key factor in the urban one.

Sediment discharge appeared to influence the size distribution of the bottom sediments of the three streams (see Table 3). The forested stream had a high quality substrate, with a third of all particles in the gravel category, and virtually no silt or clay present. In contrast, the agricultural stream had the highest percentage of sand (85%) and silt-clay (7.7%) sized particles. The urban stream, despite its high sediment load, had a surprising amount of gravel-sized particles (27%) and relatively little silt and clay (1.4%). Scour caused by higher stormwater flows may explain the substrate pattern found in the urban stream. The researchers also examined metal levels within the finer-grained sediments of the stream bottom. Surprisingly, the forested stream had the highest sediment metal levels of any of the three streams (but these did not approach any level of concern).

#### Findings: Stream Biota

The biota of the three streams was quite different, as measured by various indicators of aquatic macroinvertebrates (see Table 4). The forested stream had the greatest overall species richness, the most sensitive taxa, and the least number of pollution tolerant species. The three aquatic insect families, collectively known as

E-P-T (Ephemeroptera—mayflies, Plecoptera—stoneflies, and Trichoptera—caddisflies), were most numerous in the forested stream. The forested stream had a large number of filter feeders, collector/gatherers, and shredders, but had relatively few scrapers that feed on periphyton.

In contrast, the urban stream had low diversity in its aquatic insect community. It had the lowest taxa richness, the least taxa and abundance of EPT insects, and the greatest number of pollution tolerant species (86%). Unlike the forested stream, the urban stream had few filter feeders and no shredders, and was dominated by scrapers and collector/gatherers. The major components of the urban stream macroinvertebrate community were *Oligochaetes* and *Dipterans*, both of which tend to indicate poor water quality and soft substrates.

The agricultural stream also had a fairly poor aquatic insect community, although it was not as poor as the urban stream. The poor stream substrates present in the agricultural stream may have been a cause of the reduced taxa richness, low EPT scores, and large abundance of pollution tolerant species. The feeding groups in the agricultural stream were sharply different from the forested stream, with fewer shredders and collectors, and more filter feeders and scrapers.

Fish surveys, however, told a different story. Both the forested and agricultural streams had fish communities that could be characterized as "good," according to several indicators. Both streams had the same species richness and about the same Index of Biotic Integrity (IBI) score. The enriched agricultural stream had more unit biomass and a greater number of individual fish collected than the forested stream. By contrast, the forested stream had more sensitive fish species. Both streams were clearly in much better shape than the urban stream. The poor quality of the urban fish com-

munity is attested to by its low species richness, poor IBI score, complete absence of pollution intolerant species, small fish population and low unit biomass.

### Summary

The North Carolina study reinforces the paradigm that forested streams exhibit much higher quality than urban streams, as defined by a rather broad range of stream indicators (Table 5). The study is more ambiguous in regard to where agricultural streams fit in. By some indicators, the agricultural stream was as bad or even worse than the urban stream (e.g., nutrient enrichment, high sediment load, poor substrate quality and macroinvertebrate diversity). According to other indicators, however, the agricultural stream was hard to distinguish from the high quality forested stream, particularly in regard to fish diversity and IBI scores. The divergence among these indicators underscores the need to measure multiple indicators when analyzing watersheds. In a narrow context of the North Carolina study, it appears that agricultural streams occupy a middle ground between high quality forested stream and lower quality urban ones. Despite its high nutrient and sediment load, the agricultural stream monitored in this study clearly supported a diverse fish community.

More stream indicator research is needed before we can determine where agricultural streams really fit in. While it may be tempting to generalize from a single study, many more agricultural streams need to be sampled before we can truly compare the dynamics of urban and agricultural streams. Indeed, the term "agriculture" encompasses a bewildering variety of crops, rotations, livestock, management practices and other factors. Until this knowledge is obtained, watershed managers will probably need to use forested watersheds as the baseline from which to measure change in urban watersheds.

—TRS

### Reference

Crawford, J. K., and D. R. Lenat. 1989. *Effects of Land Use on the Water Quality and Biota of Three Streams in the Piedmont Province of North Carolina*. U.S. Geological Survey. Water-Resources Investigation Report 89-4007. Raleigh, NC. pp. 67.

**Table 2: Comparison of In-Stream Water Quality in Study Watersheds (Crawford and Lenat, 1989)**

Stream Water Constituent <sup>a</sup>	Forested Watershed	Agricultural Watershed	Urban Watershed
Total Phosphorus <sup>b</sup>	0.09	0.27	0.10
Dissolved Phosphorus	<0.01	0.05	0.02
Total Nitrogen	1.70	2.11	1.42
Dissolved Nitrogen	0.08	0.59	0.41
Total copper (µg/L)	7.9	5.0	12.5
Total lead (µg/L)	5.1	6.6	14.4
Total zinc (µg/L)	31	23	39
Mean Stream Temp. <sup>c</sup>	57	58.9	60.1
Max Stream Temp.	72.5	73.4	77.0
Sediment Discharge <sup>d</sup>	0.13	0.31	0.59

<sup>a</sup> Mean of 12-14 baseflow samples.

<sup>b</sup> Nutrient units are mg/l.

<sup>c</sup> Degrees Fahrenheit.

<sup>d</sup> Summed product of daily flow and watershed-specific suspended sediment

**Table 3: Analysis of Bottom Sediment in Study Watersheds (Crawford and Lenat, 1989)**

Size Distribution (%)	Forested Watershed	Agricultural Watershed	Urban Watershed
Gravel (greater than 2.0 mm)	35.0%	7.5%	27.0%
Sand (2.0 mm to 0.63 mm)	64.6%	84.8%	71.6%
Silt-Clay (less than 0.63 mm)	0.4%	7.7%	1.4%
Metals Levels in Bottom Sediments <sup>a</sup>	high	low	moderate

<sup>a</sup> Metals were elevated in forest watershed, but did not exceed standards.

R0079564

Table 4: Comparison of Stream Biota in Three North Carolina Watersheds

	Forested Watershed	Agricultural Watershed	Urban Watershed
<b>Macroinvertebrates Indicators</b>			
Total Taxa Richness (species)	202	169	101
EPT (% of all Taxa) <sup>a</sup>	22%	11%	5%
EPT (% abundance)	65%	24%	10%
Tolerant Species (% abundance) <sup>b</sup>	26%	71%	86%
<b>Feeding Category <sup>c</sup></b>			
• Filter Feeders	46%	47%	10%
• Scrapers	4%	16%	21%
• Shredders	4%	0%	0%
• Collector/Gatherer	34%	19%	46%
Number of unique taxa <sup>d</sup>	75	42	9
<b>Fish Indicators</b>			
Species Collected	19	19	9
Game Fish Species	6	6	3
Insectivorous Cyprinids	8%	0%	1%
Intolerant Fish Species	3	2	0
Number of Individuals	305	755	75
Biomass (grams)	3,766	8,494	503
Index of Biotic Integrity	50 / Good	48 / Good	34 / Poor

<sup>a</sup> EPT = Ephemeroptera, Plecoptera and Tricoptera insect groups, which include mayflies, stoneflies and caddisflies, are often considered intolerant of pollution.

<sup>b</sup> Pollution tolerant species were defined as Dipterans, Oligochaetes, and others.

<sup>c</sup> Proportion of taxa within each of the major feeding strategies.

<sup>d</sup> Unique taxa are defined as the number of taxa that occur solely within one stream (not found in the other two watersheds). Grossly tolerant species were excluded.

Table 5: Overall Summary of Stream Indicators

Stream Indicator	Forested Watershed	Agricultural Watershed	Urban Watershed
Nutrients	Good	Poor	Fair
Sediment Discharge	Good	Fair	Poor
Temperature	Good	Fair	Poor
Stream Substrate	Good	Poor	Fair
Macro-invertebrates	Good	Fair	Poor
Fish Diversity	Good	Good	Poor

R0079565



# Historical Change in a Warmwater Fish Community in an Urbanizing Watershed

2

Most investigators exploring the link between urbanization and stream quality sample stream indicators from a large population of urban watersheds. An alternative approach is to sample a single watershed at two points in time (i.e., take a historical snapshot of stream indicators before and after the watershed develops). Alan Weaver and Greg Garman recently applied this method to track changes in the fish community of Tuckahoe Creek, a watershed that has been shifting from rural to suburban land use over the last three decades. The study provides several interesting insights into how a warmwater fish community can change over time in response to watershed development.

Tuckahoe Creek is the last major tributary to the James River above the Fall Line in Virginia (Figure 1). The creek is 17 miles long and drains a watershed of over 40,000 acres. On average, the creek is 12 feet wide and two feet deep. Its upper reaches have a moderate gradient, and possess a substrate of sand and impacted cobble. As the creek descends toward its confluence with the James River, however, it begins to interact with a large wetland complex and wide floodplain. At this point, the creek's substrate changes to silt and detritus.

Situated only a dozen miles west of Richmond, Virginia, the Tuckahoe watershed has experienced considerable development pressure over recent decades. Several indicators of the rapid watershed change that has occurred are profiled in Table 1. In the late 1950s, for example, the watershed was dominated by forest and crops, and had a population density of only one person to every two acres. Over the next 30 years, however, population in the watershed nearly tripled, reaching an average density of 1.5 people per acre. The length of roads, water crossings and amount of riparian development also increased dramatically over this period. Although Garman and Weaver did not estimate impervious cover as part of their study, a ballpark estimate can be derived using the Stankowski population density/impervious cover equation. The equation projects that impervious cover was 5% in 1958 and grew to 12% by 1990.

The fish community of Tuckahoe Creek was extensively sampled in 1958, when the watershed was still in a rural condition. While the stream conditions reported in the 1958 survey by Flemer and Woolcott were certainly not representative of "pre-settlement conditions,"

they did not appear to have changed much from the late 1800s. Indeed, remarkably little change was observed in the Tuckahoe Creek fish community from 1958 to as far back as 1869, according to historical records.

In 1990, Weaver and Garman replicated the fish sampling methods on the same stream that had been surveyed 32 years earlier by Flemer and Woolcott. The research team pinpointed the location of six stream reaches sampled in 1958 from site landmarks, and employed the identical seining methods and sampling effort used in the earlier study. The researchers quantified changes in watershed variables between the two surveys by analyzing census data, quad maps, documents and selected aerial photography. As a further indicator of watershed change, Weaver and Garman computed the Index of Biotic Integrity (IBI) for Tuckahoe Creek during the 1990 survey, and compared it with IBI scores for Byrd Creek, a nearby reference stream in

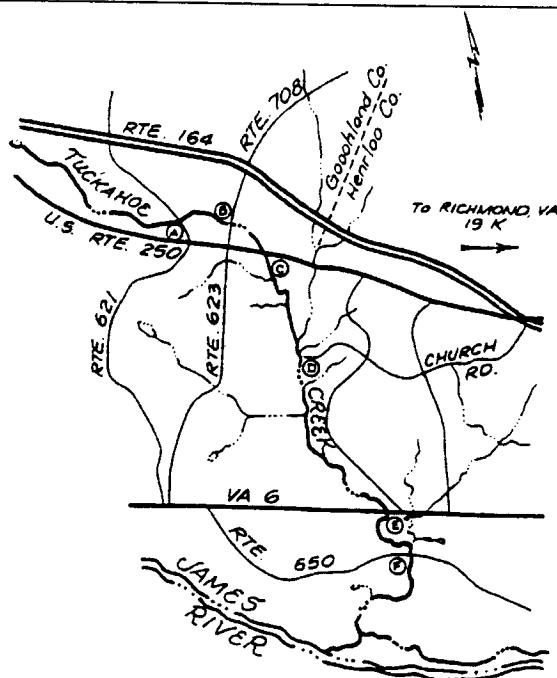

Six stations in Tuckahoe Creek were sampled in both 1958 and 1990. (Designated A-F.)

Figure 1: Location of the Tuckahoe Creek Watershed (Weaver, 1991)

**Table 1: Indicators of Watershed Change in Tuckahoe Creek: 1958 to 1990  
(Weaver and Garman, 1994)**

Watershed Indicator	1958	1990
Dominant Land Uses	crops and mixed pine/ hardwood forest	suburban land use
Dwellings	7,789	27,692
Population Density	0.54 persons/acre	1.5 persons/ acre
Road Crossings	43	85
Road Length in Basin	96 miles	227 miles
Riparian Zone Development	7%	28%
Estimated Impervious Cover <sup>a</sup>	5%	12%

<sup>a</sup> Center estimate using the Stankowski equation which computes % impervious cover based on population density.

a largely undeveloped watershed (sampling methods used in 1958 did not allow for the calculation of the IBI, so a surrogate stream was needed as a reference). In addition, Weaver and Garman also performed feeding ecology studies to determine if the diet of four dominant fish species had changed (bluegill, common shiner, bluehead chub, and johnny darter).

Weaver and Garman predicted that the 1990 fish survey would show that the watershed's gradual development over time had changed the fish community. Specifically, they hypothesized that Tuckahoe Creek would experience a reduction in fish abundance, species richness, species diversity and an increase in exotic or non-native fish species in the 32 years between surveys.

### Results

Weaver and Garman did find that the Tuckahoe Creek fish community had significantly changed from 1958 to 1990 (Table 2). For example, only 412 fish were collected in the 1990 survey compared to 2,056 in the 1958 study, despite the same sampling effort. Fish abundance declined at every site, with the greatest drop seen in the upstream reaches. Species richness also declined in the three decades between surveys. Thirty-two species representing 10 families were collected in 1958; whereas only 23 species representing nine families were collected in 1990. The most dominant species in 1990 were the bluegill and common shiner, together representing 67% of the catch. The fact that these two species fared reasonably well is not surprising since both are habitat and trophic "generalists." This means that the bluegill and common shiner can exploit a wide range of habitats and food sources, allowing them to respond to changing stream conditions over time. Still,

the populations of these hardy fish dropped from 1958 to 1990.

Populations of two other historically dominant species, the johnny darter and bluehead chub, declined by more than 55% between 1958 and 1990. Six fish species collected in 1958 were not present in 1990 (e.g., eastern silverjaw minnow, rosyface shiner, satinfin shiner, fall-fish, stripeback darter and yellow bullhead), and populations of several other species plummeted (e.g., chain pickerel, and mountain redbelly dace). Species that favor benthic habitats or depend on quality stream substrates also dropped sharply in abundance (johnny darter, pirate perch, torrent sucker, and eastern mud minnow). It was thought that greater sediment deposition and siltation that has occurred along the stream bottom in recent decades may have smothered the bottom habitats where benthic prey live. Overall, Tuckahoe Creek was scored as "fair" according to the Index of Biological Integrity, compared to a "good" rating for the reference stream (Byrd Creek, Table 3).

A disadvantage of historical fish community analysis is that other factors or events can be responsible for producing the observed change (such as floods, drought or toxic spills). While these factors can never be entirely discounted, the researchers presented indirect evidence that watershed development was a key factor. They found fish species diversity to be negatively correlated with an index of development near each sampling site. (The index was defined as the percentage of developed area in a two square kilometer riparian zone upstream of each sampling site—see Figure 2.)

Although the analysis clearly showed that the Tuckahoe creek fish community had simplified over the years, two predicted changes in the fish community did not happen. First, the predicted invasion of non-native

fish into Tuckahoe Creek did not occur during the study period. Second, fish diet analysis demonstrated that no wholesale change occurred in the trophic structure of the fish community over three decades. Other researchers have noted that the foodweb of disturbed streams are restructured, with omnivorous fish species replacing insectivores and piscivores. As Figure 3 illustrates, however, this pattern was not followed in Tuckahoe

Creek. The proportion of fish species within each of the four different feeding guilds remained about the same over time during the study.

It was concluded that the cumulative impact of gradual watershed development can, over time, rival that of shorter but more intense disturbances such as clear cutting and extreme floods. In this sense, the frequency of disturbance can be as important as its

**Table 2: Changes in Fish Community Observed from 1958 to 1990 (Weaver, 1991)**

Fish Community Indicator	1958	1990
Species Richness	32	24
Abundance	2,056	417
Exotic Fish Species	1 (bluegill sunfish)	1 (bluegill sunfish)
IBI Score	48 (good) <sup>a</sup>	40 (fair)
Most Dominant Species	Johnny darter	Bluegill sunfish
Trophic Guilds (proportion in each feeding category)	invertivores 60% omnivores 30% piscivores/herbivores 10%	invertivores 55%, omnivores 40% no herbivores

<sup>a</sup> As measured at a contemporary reference stream (Byrd Creek).

**Table 3: IBI Comparison for Tuckahoe Creek and a Reference Stream**

Index of Biotic Integrity (IBI) Metric	Tuckahoe Creek (Study Reach B)	Reference Stream (Byrd Creek)
1. Species Richness	17	22
2. Number of darter species	1	4
3. Number of sunfish species	4	2
4. Number of sucker species	3	4
5. Number of intolerant species	2	5
6. Proportion of creek chubsuckers	4.4%	0%
7. Proportion of omnivores	48%	18%
8. Proportion of insectivorous cyprinids	3.9%	19%
9. Proportion of piscivores	4.4%	7.6%
10. Number of individuals collected	24	11
11. Proportion as hybrids	0	0
12. Proportion with parasites	22.5%	11.4%
<b>TOTAL IBI SCORE</b>	<b>40 points</b>	<b>48 points</b>
<b>IBI INTEGRITY CLASSIFICATION</b>	<b>Fair</b>	<b>Good</b>

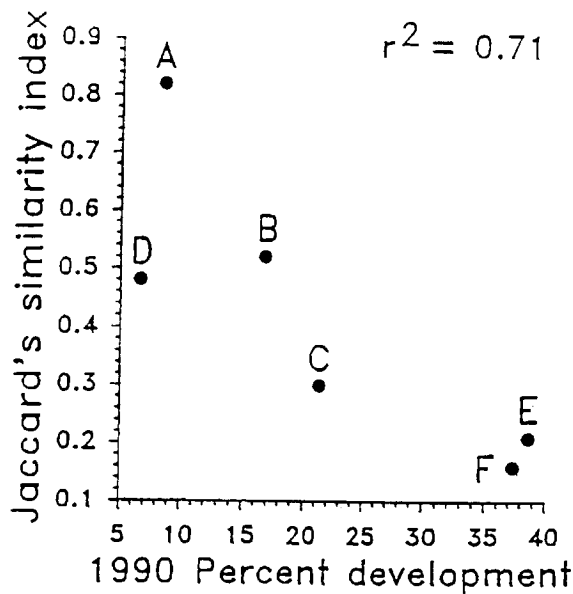

Fish diversity is measured using Jaccard's community similarity coefficient. It quantifies the presence or absence of fish species in relationship to the development index, and is used to quantify the relative degree of taxonomic similarity between faunal communities based on a cumulative listing of species' presence or absence.

**Figure 2: Relationship of a Local Development Index and Fish Diversity in Tuckahoe Creek (Weaver, 1991)**

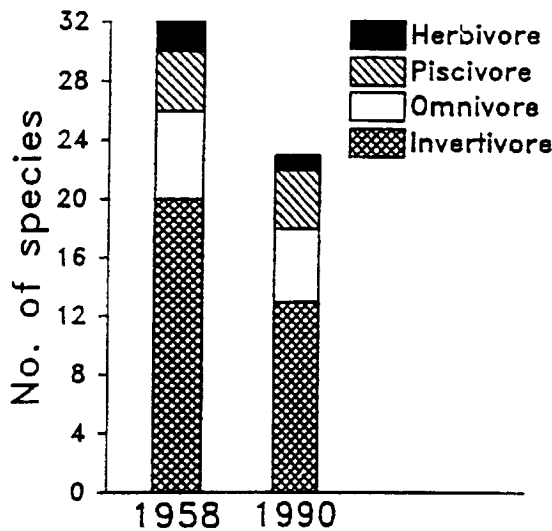

Fish species can be grouped according to their feeding habitats (or guild structure). No change in the relative proportion of species in each feeding group was observed from 1958 to 1990.

**Figure 3: Feeding Guild Structure in Tuckahoe Creek: 1958 and 1990**

intensity, as both allow little opportunity for ecological recovery. The study provides further evidence of the value of biological indicators, as they respond to and integrate all the various factors that affect a stream.

Multiple stream indicators are needed to fully understand a watershed's dynamics over time. For example, fish may be a good indicator of broad habitat change, but may not always capture subtle changes in water chemistry, flow frequency or site modifications. Other indicators, such as aquatic macroinvertebrate surveys and direct habitat measurements, are often important pieces to complete the watershed "puzzle."

The findings from the Tuckahoe Creek study are consistent with other stream ecology research that have discovered that a relatively small degree of watershed development can produce a dramatic change in the biological diversity of streams.

—JSB

**References**

Weaver, L.A. 1991. *Low-Intensity Watershed Alteration Effects on Fish Assemblage Structure and Function in a Virginia Piedmont Stream*. Unpublished Masters Thesis. Virginia Commonwealth University. 77 pp.

Weaver, L.A., and G.C. Garman. 1994. Urbanization of a Watershed and Historical Change in a Stream Fish Assemblage. *Transactions of the American Fisheries Society* 123:162-172.

R0079569

# Fish Dynamics in Urban Streams Near Atlanta, Georgia



A few short decades ago, much of the landscape of the upper Chatahoochee basin was rural in character, dominated by second growth forest and pasture. The basin's close proximity to the rapidly growing Atlanta metropolitan area, however, has created intense development pressure. For example, in the last five years, the twenty county metropolitan region has added residents at a rate of 50,000 per year—roughly equivalent to the creation of a small city every year. Watershed managers are concerned about the impact of this explosive growth on 35 major warm water streams that flow through the southern Piedmont into the Chatahoochee River. To assess the impact of watershed development, Carol Couch and her colleagues at the U.S. Geological Survey (USGS) have conducted three intensive studies of the fish community in several dozen streams that drain to the Chatahoochee River (Table 1). These studies provide fresh insights on how southeastern warm water streams respond to watershed change.

The original fish community in the warm water streams of the study area was quite diverse, based on historical collections. Some 50 fish species were represented, with 42 native species and eight recent introductions (usually from bait buckets or stocking). Min-

nnows and suckers dominate the warm water fish community, although sunfish, bass, catfish and darters are also well represented. Minnows play a critical role in the food chain as prey for larger fish, reptiles and wading birds. Suckers, which feed off the bottom of streams, often account for the most fish biomass.

### The First Fish Survey

In the first watershed study, researchers sampled fish populations at eight urban streams draining older Atlanta neighborhoods and a largely forested reference stream. The urban streams were of second to fourth order, and had watershed areas ranging from 15 to 85 square miles. Each urban watershed ranged from 70 to 90% developed (no measurements of impervious cover were available), and was primarily comprised of residential development. A single fish survey was taken in representative stream reaches within each of the nine watersheds in November 1993.

The survey confirmed that the abundance and diversity of fish declined sharply in urban streams, in comparison to the forest reference. Urban streams also had more non-native fish species than the forest stream (Figure 1). Nonnative species are often among the most

**Table 1: Comparison of Three Recent Studies on Fish and Stream Ecology in Urban Watersheds of the Chatahoochee River Basin**

Study Factors	Study No.1	Study No. 2	Study No. 3
Investigators/ Affiliation	Couch <i>et al.</i> 1995 USGS/NAWQA	DeVivo <i>et al.</i> 1997 USGS/NAWQA	Meyer <i>et al.</i> 1996 USGS/Univ. of GA
No. of watersheds sampled	9	21	8
Watershed size(square miles)	15 to 85	2 to 101	Unknown
Stream orders	2nd to 4th order	2nd to 4th order	2nd order
Watershed land use	Forest, Urban	Forest, Suburban, Urban	Forest, Suburban, Urban, Agricultural
Scope of study	Fish surveys Substrate assessment	Intensive fish survey, IBI calculation, water quality	Water quality, fish, macro invertebrates, stream ecosystem process rates.
Surveys per site	1	1 to 4	4 or more

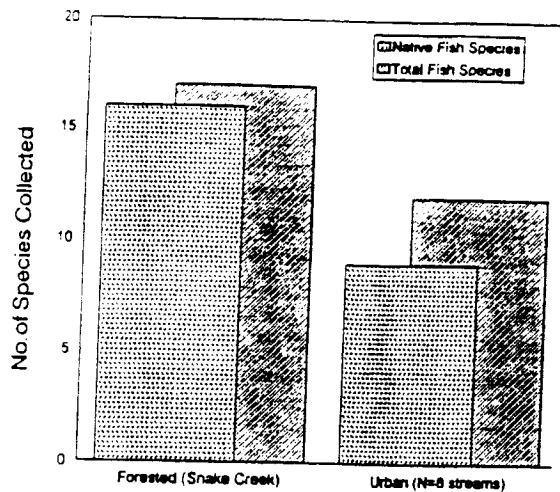

While the number of native fish species dropped from forested to urban streams, the number of non-native fish increased slightly.

**Figure 1: Comparison of Fish Species Richness and Proportion of Non-native Fish in Urban and Forested Watersheds in the Atlanta area (Couch et al., 1995)**

hardy and pollution tolerant members of the fish species, and include the red shiner, white sucker, black bullhead, flat bullhead, spotted bass, smallmouth bass, green sunfish and yellow perch. More sensitive native fish species that are endemic only to the Chattahoochee River basin were not collected from any of the urban streams. In addition, fewer individual fish were collected in most urban streams. One exception was a very high population of mosquito fish found in the urban Peachtree Creek. Mosquito fish are very tolerant of pollution, and recover quickly after episodes of stream disturbance. This is due in part to their ability to bear live young. Unlike other species, mosquito fish are not dependent on a stable and clean substrate for successful spawning (Couch et al., 1995).

The first study also found that the bottoms of many of urban streams had a higher percentage of sand than the forested stream, which can be an indicator of poor habitat quality. The researchers, however, could not find a direct relationship between substrate quality and the urban fish diversity or abundance.

#### The Second Fish Survey

Fish surveys were expanded in the second study to include 21 watersheds in the Upper Chattahoochee Basin using a stream bioassessment tool known as the Index of Biotic Integrity (or IBI). The warmwater streams ranged from second to fourth order, and were surveyed to develop a regionally appropriate IBI for Atlanta (DeVivo et al., 1997). Two forested streams were sampled to represent reference conditions.

The IBI, developed by James Karr for Midwestern streams, compares a given fish assemblage to an undisturbed stream benchmark, based on its species composition, diversity and functional organization. In the original IBI, twelve fish community metrics are measured and scored to arrive at an index of overall stream quality. It was necessary to adapt and modify the IBI for the Atlanta region to account for the unique regional differences in the warmwater fish community of the urbanizing southern Piedmont. The research team modified the IBI by conducting a statistical analysis of key variables to explain data variances in the fish community at the 21 stream sites. Based on this analysis, DeVivo and colleagues concluded that human population density was the best variable to represent watershed disturbance in the study area. (It is interesting to note that another commonly used development index—watershed impervious cover—did not provide as good of fit. Available estimates of impervious cover were not thought to be very accurate, and the research team is now using infrared satellite data to obtain better estimates). The final metrics used in the modified IBI for the Atlanta metropolitan area are profiled in Table 2.

The relationship between population density and mean IBI scores in Atlanta streams is portrayed in Figure 2. As expected, the forest reference had the highest overall IBI score of any stream. They did not, however, receive an "excellent" rating, as they lacked certain sucker and minnow species that indicate high quality conditions. It is speculated that few if any "excellent" reference streams exist in the Upper Chattahoochee basin due to prior land use change. This is not surprising when it is considered that the region has experienced three cycles of cultivation and land abandonment since the Civil War, severely eroding much of the original topsoil over the landscape (DeVivo et al., 1997). Two lightly populated agricultural streams were analyzed in the study, and their IBI scores fell into the fair/good range (29 and 30). This finding is generally consistent with findings from an agricultural stream in North Carolina (see article 22) that agricultural streams have slightly lower IBI scores than forest streams, but still score higher than urban streams.

No urban stream scored higher than "fair" in the IBI analysis. In general, urban stream IBI scores were inversely related to watershed population density. Once watershed population density exceeded four persons per acre, urban streams consistently were rated as "very poor" according to the modified IBI. The relationship between population density and urban stream IBI scores, however, was not without variation, with up to 10 points of IBI variation noted for streams of similar population density, and from two to four points of IBI variation observed at individual stream sites. The variation in IBI scores witnessed at urban streams appears to reflect the frequency and intensity of watershed disturbance that creates temporal instability in the fish community

**Table 2: IBI Metric Selection for Atlanta Region**  
(DeVivo *et al.*, 1997)

IBI Metric Category	Response to Increasing Population Density
<b>Assemblage</b>	
1. Diversity Index Score for native species	Decrease
2. Number of native sucker species	Decrease
3. Number of native cyprinid (minnow) species	Decrease
4. Proportion of non-native individuals	Increase
5. Proportion of gravel-dwelling fish	Decrease
<b>Assemblage Function</b>	
6. Proportion of generalized feeders	Decrease Faunal Shift <sup>a</sup>
7. Proportion of benthic insect eaters	
8. Dominant nest-building fish	
<b>Fish Abundance and Condition</b>	
9. Proportion of tolerant individuals	Increase
No. of native taxa, no. of individuals, and fish with lesions or parasites	No discernable trend, dropped from regional IBI

<sup>a</sup> The type of dominant nest-building fish did not just decrease but shifted from one taxa to another. In least-developed watersheds, the endemic bandfin shiner was dominant; in intermediate developed watersheds the yellowfin shiner dominated; and in the most human modified watersheds the introduced red shiner was dominant (or nest associated fish were altogether absent).

(DeVivo *et al.*, 1997). More research is underway to resolve this issue.

### The Third Fish Study

A third intensive research study is now comparing stream ecosystem function in four pairs of watersheds that span a gradient of land uses: forest, agricultural, suburban and urban. The joint monitoring study is being conducted by the University of Georgia and the USGS, and will relate watershed conditions to stream ecology. Traditional chemical and biological indicators are being supplemented by rate measurements of stream ecosystem functions, such as the input, storage and transport of carbon, nutrient transport and uptake, and community production and respiration (Meyer *et al.*, 1996). Although the stream ecosystem study is in its preliminary stages, some initial watershed comparisons are provided in Table 3.

For example, the nutrient-rich agricultural stream appears to be the most biologically productive of the four stream types. It has a surprisingly diverse fish and macro invertebrate community, high leaf decay rates, short nutrient uptake lengths, and a rapid metabolism. Algal production appears to be stimulated by the nutrients in the agricultural stream. By contrast, both the suburban and urban streams had lower biotic diversity, more exotic species, and lower nutrient levels. Early measurements of ecosystem rates indicate that primary

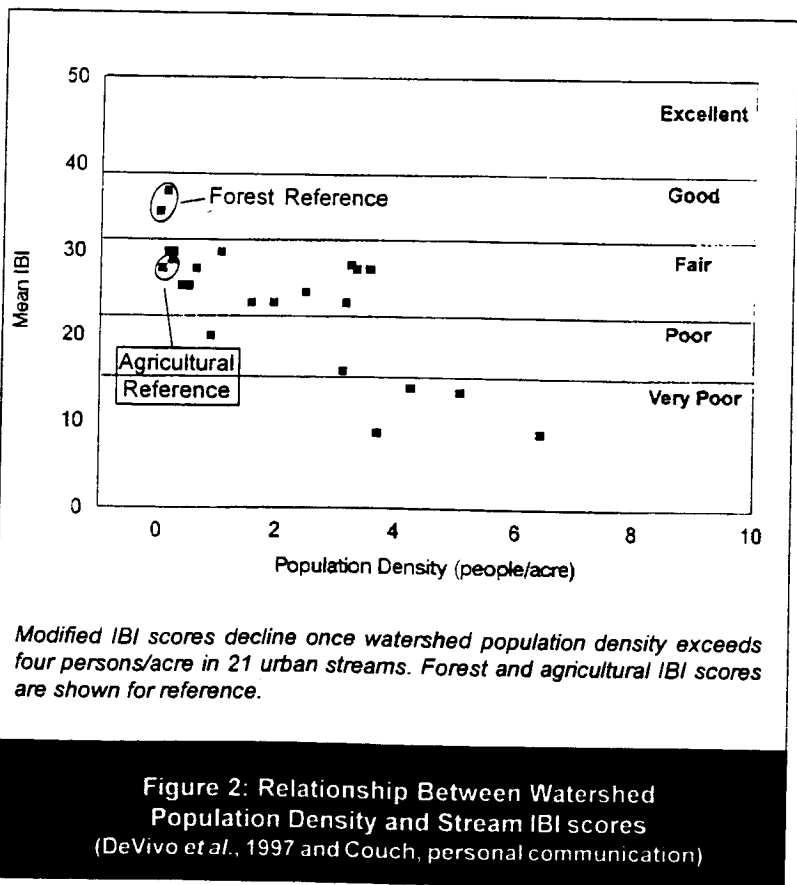

**Table 3: Preliminary Comparison of Stream Attributes for Four Types of Watersheds in the Chattahoochee River Basin (Meyer et al., 1996)**

Stream Attributes	Forested	Agricultural	Suburban	Urban
Name	Snake Creek	West Fork	Sope Creek	Peachtree Ck.
Impervious Cover (%)	<1%	<1%	30%	47%
Pop. Density (people/acre)	0.75	1.37	21	33
Total Phosphorus (mg/l)	0.17	0.64	0.15	0.20
Ammonia-N (mg/l)	0.04	0.24	0.07	0.16
EPT Index <sup>a</sup>	4	6	3	2
Benthic Organic Matter <sup>b</sup>	559	151	160	3,350
Net Daily Metabolism <sup>c</sup>	-1.6	-0.8	-2.3	-4.0
Leaf Decay Rate <sup>d</sup>	-0.0078	-0.0293	-0.0146	-0.0334
Ammonia Uptake Length <sup>e</sup>	intermediate	shortest	longest	longest

<sup>a</sup> EPT index, which is a macro invertebrate metric contained in EPA's Rapid Bioassessment Procedure, ranges from 0 to 6, with a higher score indicating greater diversity.

<sup>b</sup> Grams ash free dry weight per square meter of fine and coarse organic matter on stream bottom.

<sup>c</sup> Grams of oxygen produced (consumed) per square meter per day; negative value indicates community respiration exceeds gross primary production.

<sup>d</sup> Decay rate of leaf pack in the stream, per day.

<sup>e</sup> Distance needed for uptake of soluble nitrogen in stream which is an index of nutrient spiraling.

production in the urban and suburban streams is much lower. The reference forest stream was very retentive of the carbon and nutrients that are delivered to it from its watershed, and had high fish and macroinvertebrate diversity. A better picture of dynamics of these four stream ecosystems will be developed by further monitoring over the next several years.

In summary, the three studies clearly show that watershed development has a negative impact on urban warm water streams in the southern Piedmont. This is manifested in reduced fish abundance, lower species richness, increased nonnative fish species, lower IBI scores, reduced macro invertebrate diversity and lower community metabolism. The severity of many of these impacts can generally be related to the intensity of watershed development, as measured by watershed population density. The Atlanta studies provide the first documentation in the Southeast of the strong negative relationship between urbanization and stream quality that has been observed in other eco-regions.

—TRS

**References**

Couch, C.A., J.C. DeVivo and B.J. Freeman. 1995. *USGS/NAWQA Program: What Fish Live in the Streams of Metropolitan Atlanta?* Fact Sheet: FS-091-95. (February 1995).

Couch, C.A., E Hopkins, and P. Hardy. 1996. *Influence of Environmental Settings on Aquatic Ecosystems in the Apalachicola-Chattahoochee-Flint River Basin.* USGS Water-Resources Investigations Report 95-4278. 58 pp.

DeVivo, J.C., C.A. Couch and B.J. Freeman 1997. "Use of Preliminary Index of Biotic Integrity in Urban Streams Around Atlanta, Georgia." pp. 40-43. In: *1997 Georgia Water Resources Conference.*

Meyer, J.L., E.A. Kramer, M.J. Paul, W.K. Taulbee, and C.A. Couch. 1996. *Influences of Watershed Land Use on Stream Structure and Function.* EPA/NSF Water and Watersheds Symposium. (November 1996).



# Housing Density and Urban Land Use as Stream Quality Indicators

A large number of indicators exist to measure the amount of urbanization in a watershed, and in turn, predict stream quality. Impervious cover has traditionally been the primary indicator of watershed urbanization, but two recent studies from Ohio and Illinois focus on housing density, urban land use, and population density as indicators. These studies provide some of the first real data on relationships between urbanization and stream quality in the Midwest.

Midwestern streams have many attributes unique to the area. Most Midwestern streams flow across the gently sloping till and outwash plains created after the last great ice sheets receded from North America 10,000 years ago. Typically, these streams are low gradient, shallowly entrenched, alluvial systems with extensive associated wetlands (McNab and Avers, 1994). In terms of aquatic diversity, the Midwest has historically had the highest diversity of freshwater mussels in North America. Prior to settlement, over 80 species of freshwater mussels were present in the state of Illinois alone (INHS, 1996).

Unfortunately, over half of the remaining mussel species existing in the Midwest are now classified as endangered, threatened, or of special state concern (USFWS, 1998). The formerly extensive wetlands of the Midwest have been reduced by over 80% and intensive agricultural and land development practices have led to the straightening, channelization, and impoundment of many streams. These practices have resulted in high rates of sedimentation and nutrient enrichment in the region's streams and rivers.

Land development pressures are increasing in many Midwestern communities, rendering urbanization an even greater threat to the region's aquatic resources. For example, between 1970 and 1990, the northeastern

Illinois area population grew by a modest 4%, yet the amount of land in urban/suburban use grew by more than 33% (NIPC, 1998). This pattern of growth appears to be continuing: Census Bureau estimates indicate that the region's population has grown as much since 1990 as it had in the previous two decades (NIPC, 1998).

Over the past decade, numerous studies have linked increasing urbanization with stream degradation. The research by Chris Yoder and Ed Rankin perhaps best illustrates this relationship. They report, "Few if any, ecologically healthy watersheds exist in the older most extensively urbanized areas of Ohio and no headwater streams (i.e., draining <20 mi<sup>2</sup>) sampled by Ohio EPA during the past 18 years in these areas have exhibited full attainment of the Warmwater Habitat (WWH) use designation" (Yoder, 1995; Yoder and Rankin, 1996).

A recent study by Yoder, Dale White, and Bob Miltner (1999) of the Ohio EPA further explored the effects of urbanization on a large number of Ohio streams. This study team utilized bioassessment techniques to link land uses with stream quality in two Ohio ecoregions. Fish, benthic macroinvertebrates, stream habitat and water chemistry were sampled in urban/suburban watersheds in the Cuyahoga River basin in northeastern Ohio and smaller subwatersheds in the Columbus metropolitan area of central Ohio. The Cuyahoga watersheds are characterized by extensive development, including a mix of older residential, commercial, and industrial land uses, along with more recent suburban development. The Columbus watersheds are characterized by residential urban land use, much of which has developed within the last two decades. However, a significant difference between the Cuyahoga and Columbus study areas is that many of the sample points in the Cuyahoga drainage were located in larger

**Table 1: Sampling Parameters for the Cuyahoga and Area Streams**

Sample Location	Drainage Areas (sq. mi.)	Macro-Invertebrate Samples	Fish Samples	Habitat Assessment	Water Chemistry Samples
Cuyahoga	2 - 700	80	82	82	103
Columbus	<35	0	80	80	0

**R0079574**

**Figure 1: Index of Biotic Integrity Scores Vs. Urban Land Use (quartiles) for All Columbus Area Samples**

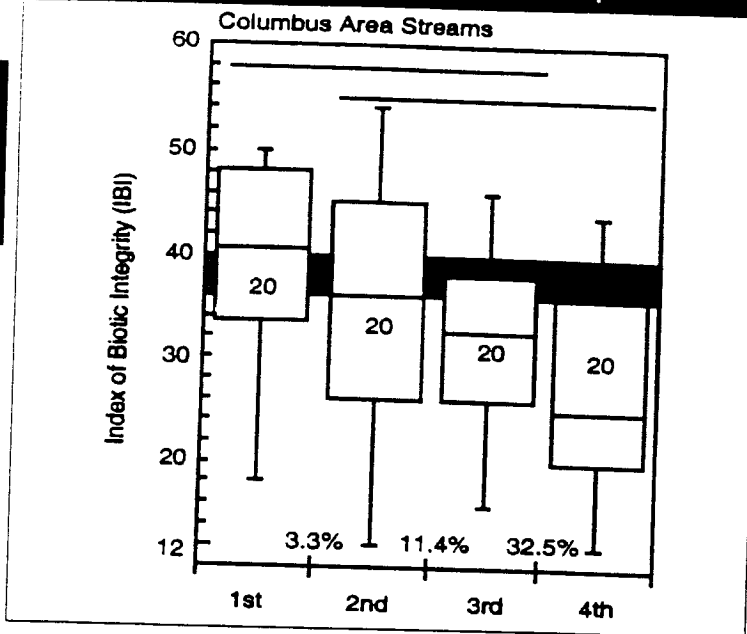

**Figure 2: Index of Biotic Integrity Scores Vs. Urban Land Use (quartiles) for All Sites in the Cuyahoga Basin**

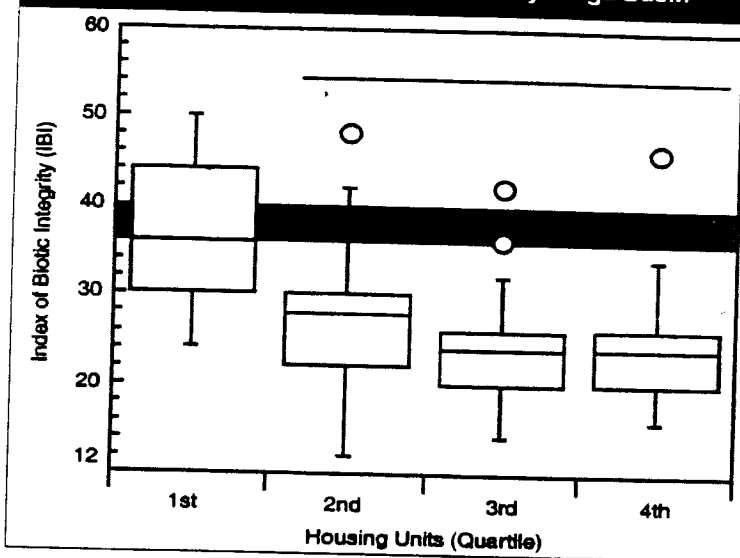

**Table 2: Predominant Impact Types in the Cuyahoga Basin**

Least impacted - large lot residential areas with significant open space
Gross in stream habitat alteration - gross channel modifications and/or impoundments
Combined sewer overflow discharges (CSOs)
Wastewater treatment plant discharges
Wastewater treatment plant discharges w/CSOs
Urbanization

watersheds that were subjected to significant point source discharges. The smaller subwatersheds of the Columbus study area had far less influence from point source discharges. Table 1 summarizes the team's sampling effort.

The researchers chose housing density and urban land use as surrogates of watershed impervious cover. These two indicators were chosen because census data, for calculating housing density, and state land use information, for calculating percent urban land, were readily available. In addition to the effects of urbanization, the study also examined the potential effects of watershed scale and significant other stressors in the urban environment. Table 2 lists the predominant stressor types in the Cuyahoga basin.

**Results**

Data from the Columbus area streams showed a significant decrease in fish assessment scores when watersheds exceeded 33% urban land use, although there was considerable variation above and below this percentage among individual watersheds (Figure 1). At this level of urbanization, fish communities displayed a shift in community composition indicated by the loss of intolerant darters and sculpins, a decrease in insectivorous fish, and an increase in the proportion of tolerant species.

Overall, the Cuyahoga basin streams depicted a significant drop in fish index of biotic integrity (IBI) scores at around 8% urban land use (Figure 2). This relatively low level of urban land use was related to a significant impact to the biological community primarily because of watershed scale and the presence of other stressors not generally found in the Columbus area streams. The researchers found that when streams with a watershed size of less than 100 mi<sup>2</sup> were analyzed separately, the level at which fish IBI scores dropped significantly increased to around 15% urban land use (Figure 3). Figure 4 illustrates this data further broken down by the type of impact. The study showed that sites affected by combined sewer outfalls, significant wastewater treatment plant outfalls, and highly modified habitats (i.e., channelized, impounded) failed to attain their appropriate biocriteria regardless of the degree of urbanization.

Housing density was also strongly linked to stream quality, but with somewhat differing results (Figure 5). While urban land use depicted a more or less continuous decline in stream quality with increasing urbanization, housing density displayed a threshold response coinciding with approximately one housing unit per acre, above which sites generally failed to attain their appropriate biological criteria.

Similar results were obtained in a study undertaken by Dennis Dreher (1997) of the Northeastern Illinois Planning Commission (NIPC). Dreher's study utilized a similar bioassessment approach with the main difference between the two studies being the choice of urbanization indicator.

The Illinois study utilized population density as an indicator of urbanization, rather than housing density or urban land use.

The six-county Northeastern Illinois study area (Cook, DuPage, Kane, Lake, McHenry, and Will counties) includes the extensively urbanized Chicago metropolitan area and its adjacent suburbs, as well as large areas of outlying rural/agricultural land. Even though discharges from point sources and combined sewer overflows in this region have been reduced dramatically over the past 20 years, many of this region's waterways remain seriously impaired.

In this study, population density was chosen as the urbanization indicator for several reasons, the most notable being the difficulty in accurately quantifying the impervious cover in a large number of watersheds on a regional scale. In contrast, digital population data was readily available for the region and could be utilized with existing GIS resources. In addition, the author felt that local land use planners and government officials readily understand population density, perhaps more so than impervious cover.

Dreher found a strong correlation ( $r^2 = 0.77$ ) between population density and fish community assessments for the Northeastern Illinois region. The majority of the streams assessed in urban/suburban watersheds with population densities of 1.5 to 8.0+ people per acre had community assessment scores in the fair to poor range, indicative of significant degradation. In contrast, nearly all the rural/agricultural streams (0.05 to 0.5 people/acre) had assessments scoring in the good or better range. However, only two of the 13 rural/agricultural streams studied scored in the excellent range. The study also found that most "suburbanizing" water-

sheds in the range of 0.5 to 1.5 people per acre scored in the fair to good range. With substantial additional development still occurring, these watersheds are at risk of significant further degradation.

### Conclusions

Both the Dreher study and the Yoder *et al.* study demonstrate that there is a strong negative relationship between increasing urbanization and stream quality in the Midwest and that bioassessment can play an important role in assessing and managing urban streams. As both studies used similar biological assessment methodologies, the efficiency and utility of the different urbanization indicators can be compared to determine which provides the best predictor of stream quality over a wide range of land use intensities and watershed scales. And indeed, all three indicators appear to provide useful information. Population density and percentage of urban land use were found to depict a continuous negative response to urbanization. Housing density, on the other hand, depicted a threshold response to urbanization. This may indicate that housing density's utility for predicting stream quality at intermediate levels of urbanization is limited. However, additional investigation will be needed in this area.

Both studies appear to have derived similar conclusions regarding the level at which significant stream degradation occurs. In analyzing their results, Yoder and his colleagues identified a threshold at one housing unit per acre, beyond which fish and macroinvertebrate assessments increasingly fail to attain their appropriate biological criteria. Assuming that one unit per acre would represent a suburban medium to low density development (single-family detached homes), then 2.5

**Table 3: Comparison of Different Land Use Indicators and Their Applicability to Local Watershed Planning**

Land use indicator	Typical value for low density residential use	Level at which significant impact observed	Advantage	Disadvantage	Appropriate scale	Utility for Local Watershed Planning
% Impervious Cover	10%	10-20%	Most accurate	Highest level of effort and cost	Sub-watershed or watershed	High
Housing Density	1 units/acre	>1 unit/acre	Low accuracy in areas of substantial commercial or industrial development, Moderately accurate at larger scales	Less accurate at smaller scales	Watershed or larger	Moderate
Population Density	2.5 people/acre	1.5 to 8+ people/acre	Low accuracy in areas of substantial commercial or industrial development, Moderately accurate at larger scales	Less accurate at smaller scales	Watershed or larger	Moderate
% Urban Land Use	10-100%	33% (variable)	Moderately accurate at larger scales	Does not measure intensity of urbanization	Watershed or larger	Low

R0079576

people per acre would be a reasonable estimate of population density (ULI, 1997). This would coincide with Dreher's category of 1.5 to 8+ people per acre, at which streams typically scored in the fair to poor range. Based upon the results of these studies, it appears that there is agreement between these two indicators of urbanization, at least in terms of a threshold for use attainment. However, population density may be a more useful tool for predicting stream quality due to its more continuous negative response to increasing urbanization.

Urban land cover was also found to be a good predictor of stream quality, but other factors such as historic development patterns, the level of direct channel alteration, and the array of land uses included as urban land may limit the precision of this indicator.

The Dreher study and the Yoder *et al.* study, as well as others, have demonstrated a clear negative relationship between increasing urbanization and stream quality. However, most assessments of this type to date have been conducted on large regional scales. Robert Steedman of the University of Toronto (1988) found that watershed scale played a significant role in the ability of the urban land use indicator to predict stream degradation. He found that large watersheds, with an average size of 112 mi<sup>2</sup>, had poor land use/stream quality correlations ( $r^2=.11$ ) when compared to small watersheds with an average watershed size of just 6.5 mi<sup>2</sup> ( $r^2=.78$ ). This would appear to reinforce the idea that watershed scale is an important factor in assessing the utility of indicators of urbanization. As land use decisions are generally

made at the local level, land use planners need tools that are applicable to smaller scale local planning areas. More work is still needed in identifying and applying these indicators at smaller scales to determine their practical usefulness in local watershed planning and management. Table 3 summarizes some

**Figure 3: Index of Biotic Integrity Scores Vs. Urban Land Use (quartiles) for All Samples With Drainage Areas <100 mi<sup>2</sup> in the Cuyahoga Basin**

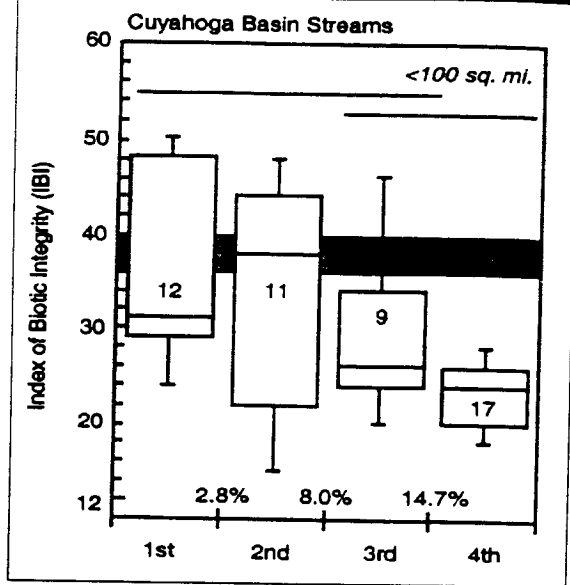

**Figure 4: Index of Biotic Integrity Scores Vs. Percent Urban Land Use (quartiles) for Cuyahoga Streams With Drainage Areas <100 mi<sup>2</sup> by Stressor Groups**

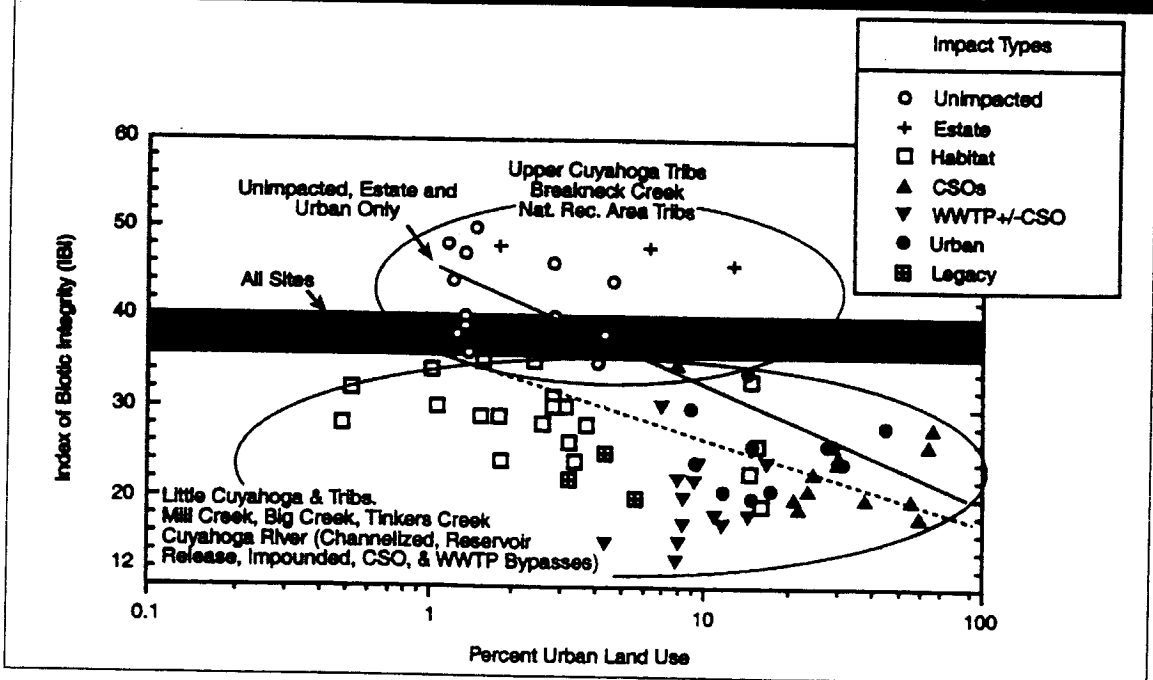

**Figure 5: Index of Biotic Integrity Scores Vs. Housing Density (quartiles) for All Sites in the Cuyahoga Basin**

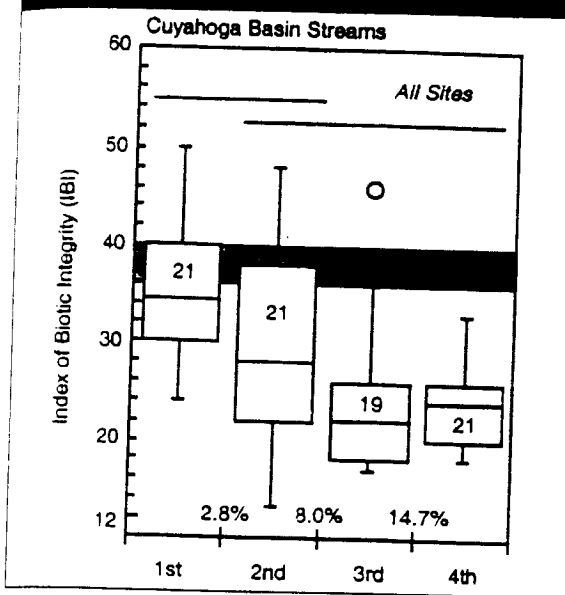

of the advantages and disadvantages of several indicators of urbanization.

Overall, the results of these two Midwestern studies reflect the substantial impacts conventional land use practices have had on the biological integrity of rivers and streams, and may be used to forecast future quality if conventional practices continue. This does not bode well for our streams and rivers, as development pressures continue to grow in many Midwestern communities. However, these relationships may not predict the future quality of our streams and rivers if watershed planning and management practices are implemented to control both point and non-point source pollution. But the authors caution that planning and management decisions should not be based upon a single indicator of urbanization, without considering significant other physical and chemical stressors (i.e., historic alteration, CSO's, failing septic systems, etc.) that may be acting on the system. - **KBB**

**References**

Dreher, D.W. 1997. "Watershed Urbanization Impacts on Stream Quality Indicators in Northeastern Illinois." pp. 129-135. in D. Murray and R. Kirshner (ed.) *Assessing the Cumulative Impacts of Watershed Development on Aquatic Ecosystems and Water Quality*. Northeastern Illinois Planning Commission. Chicago, IL.

INHS. 1996. "The Decline of Freshwater Mussels in Illinois." *Illinois Natural History Survey Reports*. May-June, 1996. Illinois Natural History Survey Champaign, IL.

McNab, W.H. and P.E. Avers. 1994. *Ecological Subregions of the United States*. United States Forest Service. Washington, D.C.

Northeastern Illinois Planning Commission (NIPC). 1998. *Policy Statement on the Regional Growth Strategy*. Chicago, IL.

Steedman, R.J. 1988. *Modification and Assessment of an Index Biotic Integrity to Quantify Stream Quality in Southern Ontario*. Can. J. Fish Aquat. Sci. 45:492-501.

Urban Land Institute. 1997. *America's Real Estate*. Washington, D.C.

USFWS. 1998. *America's Mussels: Silent Sentinels* United States Fish and Wildlife Service, Region 3 Endangered Species Home Page ([http://www.fws.gov/r3pao/eco\\_serv/endangrd/clams/mussels.html](http://www.fws.gov/r3pao/eco_serv/endangrd/clams/mussels.html))

Yoder, C.O. 1995. "Incorporating Ecological Concepts and Biological Criteria in the Assessment and Management of Urban Non-point Source Pollution." pp. 183-197. in D. Murray (ed.). *National Conference on Urban Runoff Management: Enhancing Urban Watershed Management at the Local, County, and State Levels*. EPA/625/R-95/003

Yoder, C.O. and E.T. Rankin. 1996. *The Role of Biological Indicators in a State Water Quality Management Process*. J. Env. Mon. Assess. 51(1-2): 61-88

Yoder, C.O., R. Miltner, and D. White. 1999. "Assessing the Status of Aquatic Life Designated Uses in Urban and Suburban Watersheds." pp. 16-28. In R. Kirshner (ed.). *National Conference on Retrofit Opportunities for Water Resource Protection in Urban Environments*. EPA/625/R-99/002.

2

R0079578

# A Study of Paired Catchments Within Peavine Creek, Georgia

**2**

Most studies that have evaluated the relationship between impervious cover and stream quality were conducted by measuring dozens of catchments or subwatersheds. Fewer investigations have utilized the paired watershed study design, in which two nearby catchments of different levels of impervious cover are intensively studied over time to assess comparative conditions and impacts.

Recent work by Barrett Walker (1996) is an example of such a paired catchment study. The study, conducted in metropolitan Atlanta, provides further evidence that impervious cover is a good indicator of overall stream health. The study suggests that impervious cover as low as 5% within a catchment can be correlated to early signs of channel erosion and instability.

### *Differences Between the Two Catchments*

For a paired catchment study to be most effective, it is important to choose catchments with nearly identical physical characteristics (e.g., order, slope, aspect, length, etc.). This makes it easier to detect differences in stream dynamics (such as biological diversity, flow, pollutant loads, and channel stability), in response to an independent variable (in this case, impervious cover). As can be seen from Figure 1 and Table 1, the two catchments in this study have remarkably similar physical characteristics.

The paired catchments are located within a larger urban watershed called Peavine Creek. The catchments are similar in size, aspect, slope, and soils and receive

virtually identical rainfall. The major contrast is in impervious cover. The Fernbank Forest catchment (77 acres and 5% impervious) is protected as an urban forest preserve and serves as the reference catchment, while the Deepdene Park catchment (89 acres and 19% impervious) serves as the impacted catchment. The development that is present in the catchments is predominantly residential and relatively dated (i.e., older than 50 years); however, there is a small component of institutional land use in the Fernbank Forest catchment.

The Deepdene neighborhood was designed at the turn of the century by the eminent landscape architect Frederick Law Olmsted. Public sewer exists in both catchments, located within the street rights-of-way and away from the channels. Deepdene Branch is fed by a storm drain collection system that collects and conveys runoff from roofs, roads, and driveways before it is discharged to the stream. The Fernbank Branch, in contrast, has a relatively small number of homes and accompanying roads, and the majority of the runoff occurs as overland flow across the forest floor. Both catchments benefit from a well-established forested riparian buffer; however, the buffer width of the Deepdene Branch is significantly narrower than that of the Fernbank Branch (see Figure 1).

### *Study Methods*

Biological, flow, suspended sediment, and channel geometry data were collected as part of the study. The sampling methods used were simple, rapid, and not the most sophisticated possible; however, they

**Table 1: Summary of Catchment Characteristics**

<b>Descriptive Data</b>	<b>Deepdene Catchment</b>	<b>Fernbank Catchment</b>
Watershed Area (acres)	89	77
Imperviousness (%)	19	5
Stream Length (ft)	2,297	2,625
Stream Slope (%)	3.3	3.4
Watershed Orientation	West	West NW
Drainage Infrastructure	storm drains outfall to stream	none - overland flow
Riparian Buffer	Good	Excellent

were adequate to observe the dynamics of urban stream catchments with relatively low impervious cover.

The macroinvertebrate analysis utilized a local Georgia *Adopt-A-Stream* protocol. The protocol generates a weighted index value based on the presence of "sensitive," "somewhat tolerant," and "tolerant" species. Qualitative ratings are assigned in the following manner: poor (<11); fair (11 - 16); good (17 - 22); and excellent (>22).

To estimate dry and wet weather flows, stream gauges were located at the lower ends of the two catchments. Discharge was then estimated based on channel geometry and velocity measurements. Suspended sediment samples were collected using a standard grab sample technique during stormflow events. The samples were collected at the same locations that the discharge estimates were made. Diagnostic channel stability data were collected with respect to substrate, slope, and cross-sectional geometry. These methods were able to qualitatively characterize the relative stability of the channels along different reaches and to relate them to catchment conditions such as impervious cover.

#### Macroinvertebrate Survey

Eight sampling events at a single sampling station on each stream occurred over a one-year period. The results of the macroinvertebrate sampling (Figure 2) indicate that the Fernbank Branch consistently scored in the excellent range (average score of 27), while the Deepdene Branch scored between fair and good (average score of 15).

Fish surveys were also conducted as part of a larger study. The Fernbank Branch survey found two species of fish and numerous salamanders, while the Deepdene Branch contained no fish and an occasional salamander. Lack of fish abundance and diversity may also be attributable to the small size of the streams and catchments.

#### Streamflow Analysis

Streamflow measurements were made in both drainages during wet and dry weather conditions. For the dry weather measurements, flows were recorded during 1994 (a wet year - about 60 inches of annual precipitation) and 1995 (an average year - about 53 inches of annual precipitation). In both instances, the base flows in the Deepdene Branch were about one third that of the Fernbank Branch. Differences in infiltration due to the export of runoff from impervious cover was suspected as the cause for the low base flow in Deepdene Branch; however, there are no historic flow data (i.e., prior to development in Deepdene Branch) to document this assertion.

Stream response to rainfall was evaluated on a

limited basis in 1995. The events covered a broad range of rainfall depths (0.01 in - 1.3 in). The data indicate that the runoff response in the Deepdene Branch is 2.5 to six times greater than in the Fernbank Branch. This disparity is likely attributable to the amount of impervious cover in the drainages.

#### Suspended Solids

Total suspended solids (TSS) were used as an indicator of sediment movement. Suspended sediment concentrations in the Deepdene Branch increased proportionately with rainfall and yielded significant concentrations for all but light (i.e., <0.02 in) rainfalls. The response pattern in the Fernbank Branch was much less extreme, where even moderate to heavy rainfalls yielded relatively low concentrations of suspended sediment. Diagnostic sampling within the Deepdene drainage indicated that the majority of the sediment load is attributed to channel erosion as opposed to sediment

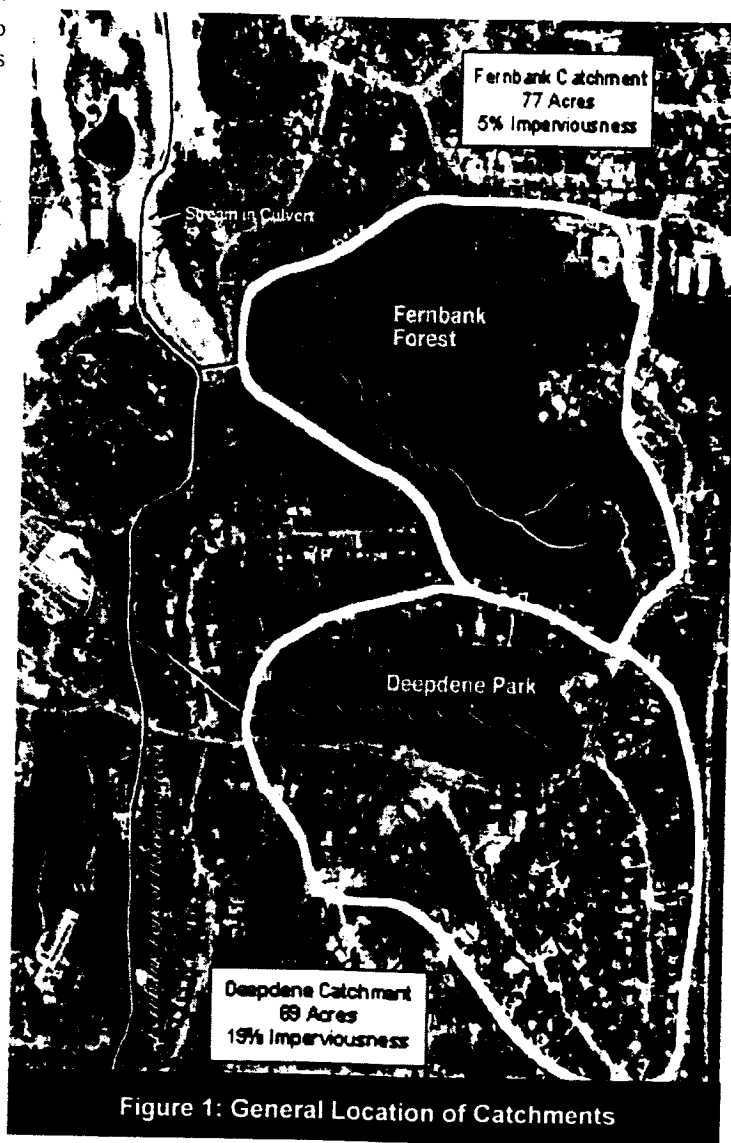

Figure 1: General Location of Catchments

Stream Indicator	Fernbank	Deepdene
Catchment Imperviousness	5 %	19 %
Macroinvertebrates	excellent	fair
Baseflow	3 times greater than Deepdene	one third that of Fernbank
Stormflow	2.5 to 6 times less than Deepdene	2.5 to 6 times greater than Fernbank
Suspended Sediment	>1,200 ppm in 1.3 inch rainfall	< 300 ppm in 1.3 inch rainfall
Channel Geometry	generally stable	significant downcutting visible along entire reach of stream

being transported from impervious surfaces into the stream.

*Stream Geometry*

The amount of sediment generated from each catchment can generally be related to their relative channel stability. Channel geometry in the Fernbank and Deepdene Branches was evaluated along four reaches of stream in each drainage. The analysis was largely a qualitative assessment of the two catchments.

The Deepdene channel showed signs of significant downcutting, particularly at culvert outlet locations. The lower reach of the Deepdene channel was somewhat held in check by a road culvert which served as a hard control that prevents further downcutting. However, the culvert had itself been eroded by the increased volumes and frequencies of flow in the channel. In addition, the concentration of the increased flows by the culvert had exacerbated the downstream erosion.

The Fernbank channel was found to be much more stable than the Deepdene channel. However, there was recent evidence of channel erosion in the headwater reach of Fernbank channel. This is significant as it is this

area of the catchment that is developed and recently experienced new residential construction. The construction resulted in the concentration of driveway and rooftop runoff from several area homes into a small V-shaped gully upstream from the source springs of the main channel. In just one year, the gully eroded into a scour hole and threatens to continue to downcut.

**Summary**

A summary of Walker's findings are presented in Table 2. This paired catchment study provides further evidence that impervious cover is a good indicator of overall stream health. At 19% imperviousness, the Deepdene Branch shows multiple signs of impacts from urbanization. Base flow is diminished, stormflows are larger and more frequent, sediment loads are higher, and the channel is largely unstable. The headwater development within the Fernbank drainage, despite its small overall contribution to the makeup of the catchment, has the potential to greatly alter the current excellent stream health unless certain stormwater management measures are implemented. While the impact can largely be attributed to the small size of the catchment, the location of the disturbance within the catchment, and the absence of effective stormwater controls, it nonetheless suggests that, even at 5% imperviousness, receiving streams can be significantly impacted by increased runoff. - EWB

Figure 2: Macroinvertebrate Data (Using the Georgia Adopt-a-Stream Index)

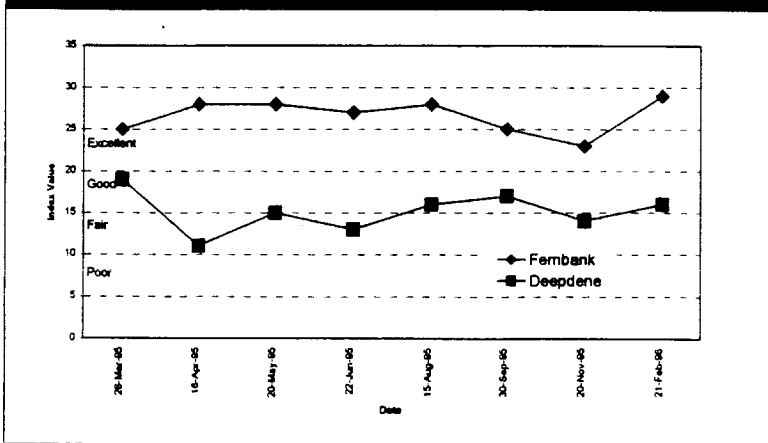

**References**

Center for Watershed Protection, 1998. *Rapid Watershed Planning Handbook: A Comprehensive Guide for Managing Urbanizing Watersheds*. Ellicott City, MD.

Center for Watershed Protection, 1994. *Watershed Protection Techniques*. Volume 1, No. 4.

Walker, Barrett, 1996. *Community-Based Urban Watershed Protection: A Case Study for Atlanta, Georgia of Peavine and South Peachtree Creeks*. Master Thesis. University of Georgia.



# Section 3: Watershed Planning

## Watershed Protection Tool #1

**W**atershed planning is the first and perhaps most important watershed protection tool, as our future land use decisions fundamentally shape and influence the health of any water body. The objective of a watershed plan is to evaluate the impact of land use decisions on the watershed, and then shift the amount and location of future impervious cover to maintain the level of watershed quality desired by a community. This is not an easy task, and cannot be accomplished in a single study or report. Effective watershed planning requires continuous involvement and long-term commitment by local governments and watershed advocates. Indeed, many early watershed planning efforts neglected this point, and therefore failed to provide much long term protection for the watershed. Article 29 examines other reasons why watershed plans have failed in the past, and provides some practical tips on how to overcome these obstacles.

To be effective, then, a watershed manager must coordinate a complex planning process that will lead to real implementation. During this process, watershed managers face a common series of tasks. First, he or she must predict what will happen to water resources in the face of future land development. This can be quickly done by using the impervious cover/stream quality model described in article 28, but other models or indicators may be more suitable, depending on the type of watershed. Second, the watershed manager must work with watershed stakeholders to agree on the most important water resource goals that will drive the plan. A realistic future land use plan for the watershed can only be developed after these community goals are established. At this point, the watershed manager must choose the most economic and politically acceptable land use planning tools that can limit the creation of new impervious cover. In addition, he or she must decide how to adapt and apply the other seven watershed protection tools, which are summarized in article 27 and described in much greater detail in sections four to 10 of this book.

Lastly, a watershed manager must create a watershed management organization that can advocate for the implementation of the plan. This last task is particularly important, since any plan that changes land use or calls for greater regulation of development will be inherently controversial. Many private landowners and developers already have a strong financial stake in the current land use plan or development regulations. They understand the old rules, have made bets on its outcome, and prefer that it stays the same. And in the real world, they often wield great influence with local elected leaders and planning authorities.

Consequently, a strong watershed organization is needed to effectively counterbalance these economic interests. Not only can watershed organizations speak on behalf of the watershed, they are often the most direct way to reach and educate the public about what is truly at stake in the watershed. Only a watershed organization that involves all stakeholders, including landowners and developers, can demonstrate the deep and wide support for the plan to elected leaders. And lastly, only a watershed organization can be a true watchdog, and ensure that the paper plan is actually realized on the ground.



Perhaps the best justification for watershed planning is that it can maintain free watershed services that would otherwise need to be replaced at great cost. The economic case for watershed protection is made in article 30, which suggests that the modest additional cost for government and developers in watershed protection is more than compensated for by increased benefits to adjacent property owners and the community at large.

---

"A watershed manager must coordinate a complex planning process that will lead to real implementation."

---

R0079582

### *Watershed Planning Trends in Last Decade*

The last decade has seen a great shrinking in the scale at which watershed planning is performed. Most plans are now conducted on smaller watersheds (or more precisely, subwatersheds) that range from two to 20 square miles in size. The advantages of this shift to subwatershed planning are outlined in articles 28 and 29.

In recent years, planners have adopted impervious cover as the primary indicator of current and future watershed health. This trend coincides with the rapid development of geographic information systems (GIS) that also occurred in the last decade. Armed with a wealth of easily accessible watershed information, planners can analyze watersheds and prepare maps at a speed that was inconceivable just a few years ago. These trends have ushered in a new era of rapid watershed planning, in which subwatershed plans can be performed in months rather than years, and for a fraction of the cost. These rapid methods are described in greater detail in the Center's *Rapid Watershed Planning Handbook*. A small but growing number of communities are now experimenting with this new approach, but it is too early to tell whether this new generation of watershed plans can change existing land use and practices enough to meet watershed protection goals.

### *Research Needs in Watershed Planning*

As impervious cover becomes more of a standard currency in watershed planning, more accurate and precise measurements of the relationship between specific land uses and impervious cover levels are needed. For example, does the impervious cover level associated with a land use or zoning category vary depending on the era in which it was built or its distance from the urban core? How much does the land use/impervious cover relationship really change when a community applies watershed protection tools such as open space subdivisions, aquatic buffers or better site design? Research is needed to answer to these questions, not only to improve our capacity to accurately forecast impervious cover in the future, but also to better manage it in our current planning efforts.

Watershed planning has always been envisioned as a continuous cycle of planning, implementation and monitoring. It is possible to improve our management efforts in each cycle, but only if we critically analyze and learn from the success and failure we encounter in past cycles. This kind of retrospective analysis can only be done if we set clear and measurable outcomes for the watershed plans we are preparing today.

## **Watershed Planning Contents**

27.	The Tools of Watershed Protection .....	133
28.	Basic Concepts in Watershed Planning .....	145
29.	Crafting Better Watershed Plans .....	162
30.	The Economics of Watershed Protection .....	171
31.	Microbes in Urban Watersheds: Implications for Watershed Managers .....	183
32.	Methods for Estimating Effective Impervious Area of Urban Watersheds .....	193

# The Tools of Watershed Protection

In this article, we outline a watershed protection approach that applies eight tools to protect or restore aquatic resources in a subwatershed. These tools are as follows:

- Tool 1. Land Use Planning
- Tool 2. Land Conservation
- Tool 3. Aquatic Buffers
- Tool 4. Better Site Design
- Tool 5. Erosion and Sediment Control
- Tool 6. Stormwater Treatment Practices
- Tool 7. Non-Stormwater Discharges
- Tool 8. Watershed Stewardship Programs

The practice of watershed protection is about making choices about what tools to apply, and in what combination. The eight watershed protection tools roughly correspond to the stages of the development cycle from initial land use planning, site design, and construction through home ownership (see Figure 1). As a result, a watershed manager will generally need to apply some form of all eight tools in every watershed to provide comprehensive watershed protection. The tools, however, are applied in different ways depending on what category of subwatershed is being protected.

The remainder of this article describes the nature and purpose of the eight watershed protection tools, outlines some specific techniques for applying the tools, and highlights some key choices a watershed manager should consider when applying or adapting the tools within a given subwatershed. Each of these tools is an essential element of a comprehensive watershed protection approach and their goal is to provide local communities with a realistic approach for maintaining a quality environment for future generations.

## Tool #1: Land Use Planning

Since impervious cover has such a strong influence on subwatershed quality, a watershed manager must critically analyze the degree and location of future development (and impervious cover) that is expected to happen in a watershed. Consequently, land use planning ranks as perhaps the single most important watershed protection tool. When preparing a watershed plan, a watershed manager needs to do the following:

- Predict what will happen to water resources in the face of future land use change.
- Obtain consensus on the most important water resource goals for the watershed.
- Develop a future land use pattern for the subwatersheds within the watershed that can meet those goals.
- Select the most acceptable and effective land use planning technique to reduce or shift future impervious cover.
- Select the most appropriate combination of other watershed protection tools to apply to individual subwatersheds.
- Devise an ongoing management structure to adopt and implement the watershed plan.

### Land Use Planning Techniques

Watershed planning is best conducted at the subwatershed scale, where it is recognized that stream quality is related to land use and consequently impervious cover. One of the goals of watershed planning is to shift development toward subwatersheds that can support a particular type of land use and/or density. The basic goal of the watershed plan is to apply land use planning techniques to redirect development, preserve sensitive areas, and maintain or reduce the impervious cover within a given subwatershed.

A wide variety of techniques can be used to manage land use and impervious cover in subwatersheds. Some of these techniques include the following:

- Watershed based zoning
- Overlay zoning
- Urban growth boundaries
- Large lot zoning

Local officials face hard choices when deciding which land use planning techniques are the most appropriate to modify current zoning. These techniques have been employed in a wide variety of watershed applications by many local governments across the country.

**Watershed-Based Zoning:** This specialized technique is the foundation of a land use planning process using subwatershed boundaries as the basis for future land use decisions. Watershed based zoning involves defining existing watershed conditions, measuring current and potential future impervious cover, classifying



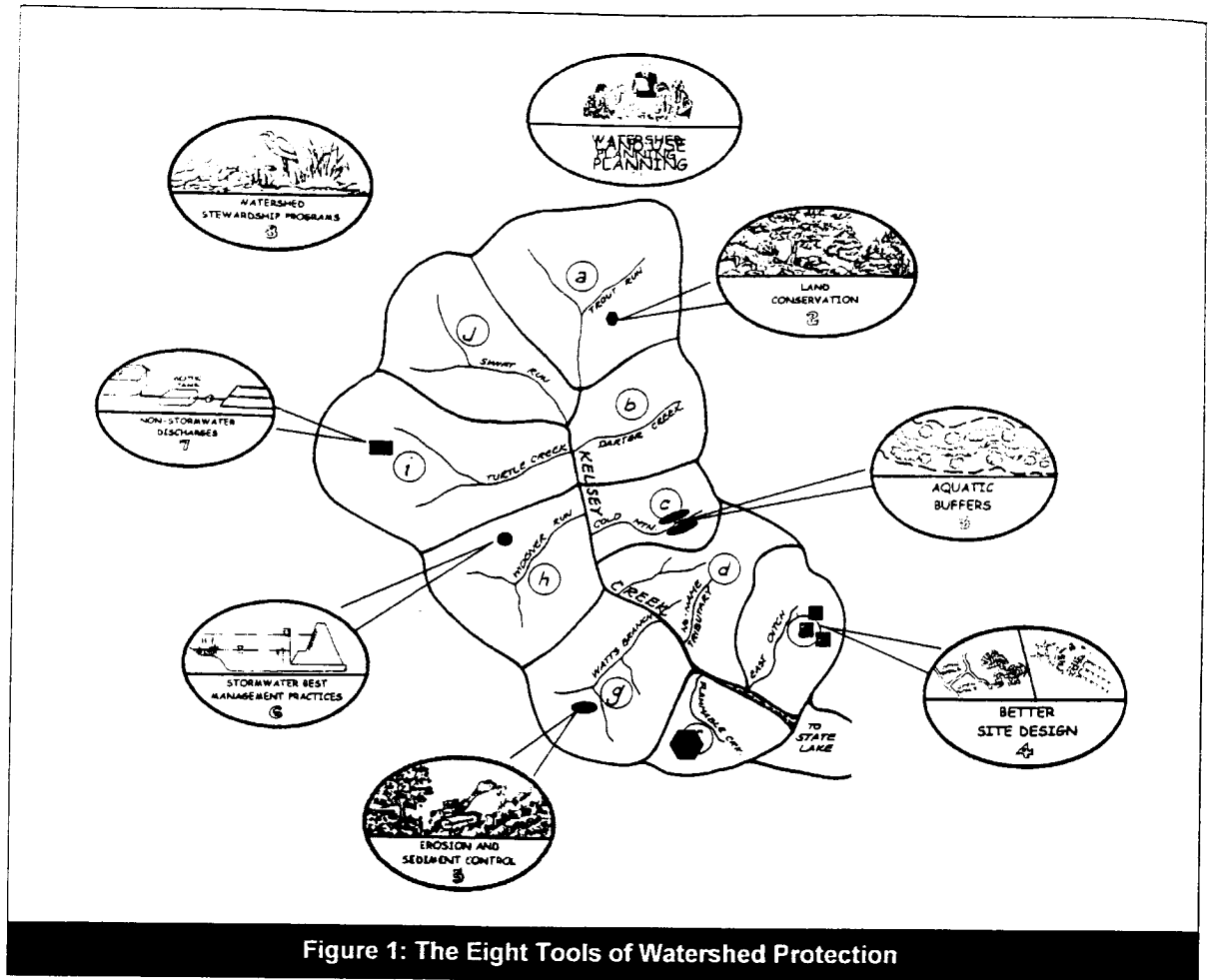

Figure 1: The Eight Tools of Watershed Protection

subwatersheds based on the amount of future imperviousness, and most importantly modifying master plans and zoning to shift the location and density of future development to the appropriate subwatershed management categories. An example of subwatershed management categories within a watershed is shown in Figure 2. Watershed based zoning can employ a mixture of land use and zoning options to achieve desired results. A watershed based zoning approach should include the following nine steps:

1. Conduct a comprehensive stream inventory.
2. Measure current levels of impervious cover.
3. Verify impervious cover/stream quality relationships.
4. Project future levels of impervious cover.
5. Classify subwatersheds based on stream management "templates" and current impervious cover.
6. Modify master plans/ zoning to correspond to subwatershed impervious cover targets and other management strategies identified in Subwatershed Management Templates.
7. Incorporate management priorities from larger watershed management units such as river basins or larger watersheds.

8. Adopt specific watershed protection strategies for each subwatershed.
9. Conduct long term monitoring over a prescribed cycle to assess watershed status.

**Overlay Zoning:** This land use management technique consists of superimposing additional regulatory standards, specifying permitted uses that are otherwise restricted, or applying specific development criteria onto existing zoning provisions. Overlay zones are mapped districts that place special restrictions or specific development criteria without changing the base zoning. The advantage is that specific criteria can be applied to isolated areas without a threat of being considered spot zoning. Overlay districts are not necessarily restricted by the limits of the underlying base zoning. An overlay zone may take up only a part of an underlying zone or may even encompass several underlying zones. Often the utilization of an overlay zone is optional. A developer can choose to develop a property according to the underlying zoning provisions. However, in order to develop certain uses or certain densities, the overlay provisions kick-in. Overlay zones can also be created

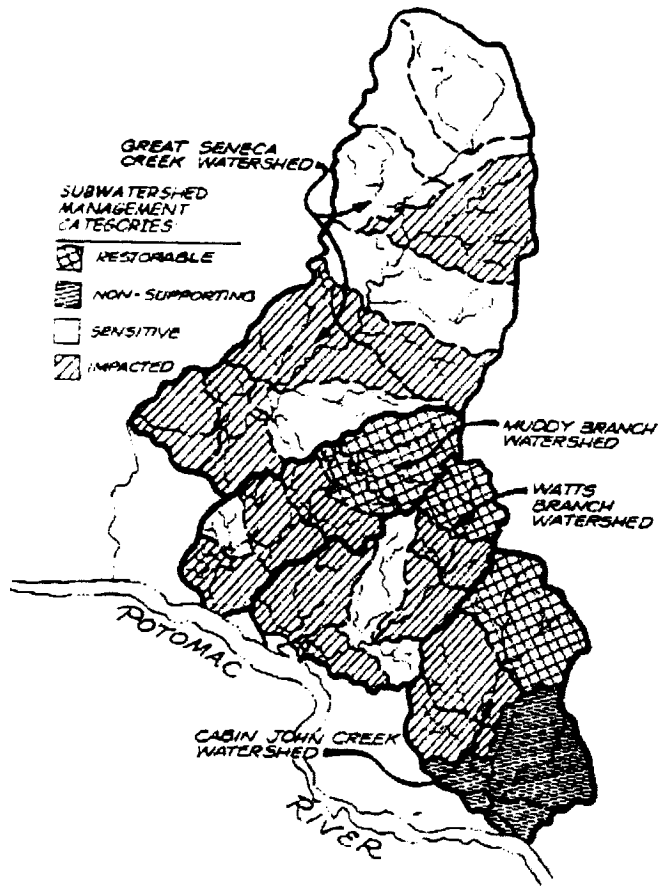

Figure 2: Illustration of the Subwatershed Management Categories for Watershed Planning (MCDEP, 1998)

3

to protect particular resources such as wetlands, forests, or historic sites. Here the provisions of the overlay zone incorporate mandatory requirements which restrict development in some way to reach the desired end.

**Urban Growth Boundaries:** This planning technique establishes a dividing line between areas appropriate for urban and suburban development, and areas appropriate for agriculture, rural and resource protection. Boundaries are typically set up for a 10 or 20 year period and should be maintained during of the life of the planning period. Boundaries may be examined at planning period renewal intervals to assess whether conditions have changed since they were established. Boundaries should rarely be changed between planning cycles to ensure a consistent playing field for both the marketplace and citizens.

Urban growth boundaries are sometimes called development service districts, and include areas where public services are already provided (e.g., sewer, water, roads, police, fire, and schools). The delineation of the boundary is very important. There are several

important issues to consider in establishing an urban growth boundary. These include the following:

- Public facilities and services must be nearby and/or can be provided at reasonable cost and in a specific time frame.
- A sufficient amount of land to meet projected growth over the planning period must be provided.
- A mix of land uses must be provided.
- The potential impact of growth within the boundary on existing natural resources should be analyzed.
- The criteria for defining the boundary needs to be fair and should consider natural features (versus man-made features) wherever possible. The use of watershed boundaries as the urban growth boundary is one such natural feature.

**Large Lot Zoning:** This land use planning technique is perhaps most widely used to try to mitigate the impacts of development on receiving water quality. The technique involves zoning land at very low densities to disperse impervious cover over large areas. Densities of one lot per two, five, or even 10 acres is not uncommon.

R0079586

From the standpoint of watershed protection, large lot zoning is most effective when lots are extremely large (five to 20 acre lots). While large lot zoning does tend to reduce the impervious cover and therefore the amount of stormwater runoff at a particular location, it also spreads development over vast areas. The road networks required to connect these large lots can actually increase the total amount of imperviousness created for each dwelling unit (Schueler, 1995). In addition, large lot zoning contributes to regional sprawl. Sprawl-like development increases the expense of providing community services such as fire protection, water and sewer systems, and school transportation.

### Key Land Use Planning Choices for the Watershed Manager

When applying the land use planning tool, watershed managers need to answer some hard questions relating to land use and watershed planning:

- What are the most economically and politically acceptable land use planning technique(s) that can be used to shift or reduce impervious cover among my subwatersheds?
- How accurate are the estimates of the amount and location of future impervious cover in my watershed? Are better projections needed?
- Will future increases in impervious cover create unacceptable changes to a watershed and/or subwatershed?
- Which subwatersheds appear capable of absorbing future growth in impervious cover?

### Tool #2: Land Conservation

While the first tool emphasizes how much impervious cover is created in a watershed, the second tool concerns itself with land conservation. Five types of land may need to be conserved in a subwatershed:

- **Critical habitats** for plant and animal communities
- **Aquatic corridors** along streams and shorelines
- **Hydrologic reserve areas** that sustain a stream's hydrologic regime
- **Water hazards** that pose a risk of potential pollution spills
- **Cultural/historical areas** that are important to our sense of place

A watershed manager must choose which of these natural and cultural areas must be conserved in a subwatershed in order to sustain the integrity of its aquatic and terrestrial ecosystems, and to maintain desired human uses from its waters. Table 1 includes descriptions and examples of these five conservation areas.

While land conservation is most important in sensitive subwatersheds, it is also a critical tool in other subwatershed management categories. Each subwatershed should have its own land conservation strategy based on its management category, inventory of conservation areas, and land ownership patterns.

The five conservation areas are not always clearly differentiable. Some of the natural areas may overlap among the conservation areas. For example, a freshwater wetland may serve as a critical habitat, be part of the aquatic corridor and also comprise part of the hydrologic reserve areas. However, the bulk of the most critical areas are covered in at least one of these five categories.

### Techniques for Conserving Land

Different land management techniques are needed to conserve natural areas. These techniques depend on the type of conservation area and subwatershed being managed. Each subwatershed contains a unique mixture of conservation areas and requires careful choices for land conservation, depending on the goal of the subwatershed plan, geographic region, and stakeholder consensus.

There are numerous techniques that can be used to conserve land which provide a continuum ranging from absolute protection to very limited protection. Some of the major land conservation techniques include:

- Land Acquisition
- Conservation Easements
- Regulate Land Alteration
- Exclusion or Setback of Water Pollution Hazards
- Protection within the Green Space of Open Space Designs
- Landowner Stewardship
- Public Sector Stewardship





### Key Land Conservation Choices for the Watershed Manager

When applying the land conservation tool, a watershed manager must make some careful choices about the mix of conservation areas to protect and what techniques to employ. Given the large areas that need to be conserved within some subwatersheds, many different conservation techniques need to be applied to cover the patchwork of public and private lands across a subwatershed.

Some of the land conservation choices a watershed manager often has to make include:

- What fraction of my subwatershed needs to be conserved?
- What are the highest priorities for land conservation in my subwatershed?
- Who will manage these conservation areas over the long-term?

**Table 1: Description and Examples of the Five Conservation Areas**

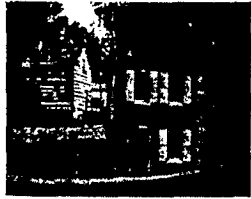
Conservation Area	Description	Examples
<p><b>Critical Habitat</b></p> 	<p>essential spaces for plant and animal communities or populations</p>	<p>tidal wetlands, freshwater wetlands, large forest clumps, springs, spawning areas in streams, habitat for rare or endangered species, potential restoration areas, native vegetation areas, coves</p>
<p><b>Aquatic Corridor</b></p> 	<p>area where land and water interact</p>	<p>floodplains, stream channels, springs and seeps, steep slopes, small estuarine coves, littoral areas, stream crossings, shorelines, riparian forest, caves, and sinkholes</p>
<p><b>Hydrologic Reserve</b></p> 	<p>undeveloped areas responsible for maintaining the predevelopment hydrologic response of a subwatershed</p>	<p>forest, meadow, prairie, wetland, crop pasture or managed forest</p>
<p><b>Water Pollution Hazard</b></p> 	<p>any land use or activity that is expected to create a relatively high risk of potential water pollution</p>	<p>septic systems, landfills, hazardous waste generators, above or below ground tanks, impervious cover, surface or subsurface discharge of wastewater effluent, land application sites, stormwater "hotspots," pesticide application, industrial discharges, and road salt storage areas</p>
<p><b>Cultural/Historical Reserves</b></p> 	<p>areas that provide a sense of place in the landscape and are important habitats for people</p>	<p>historic or archeologic sites, trails, parkland, scenic views, water access, bridges, and recreational areas</p>



R0079588

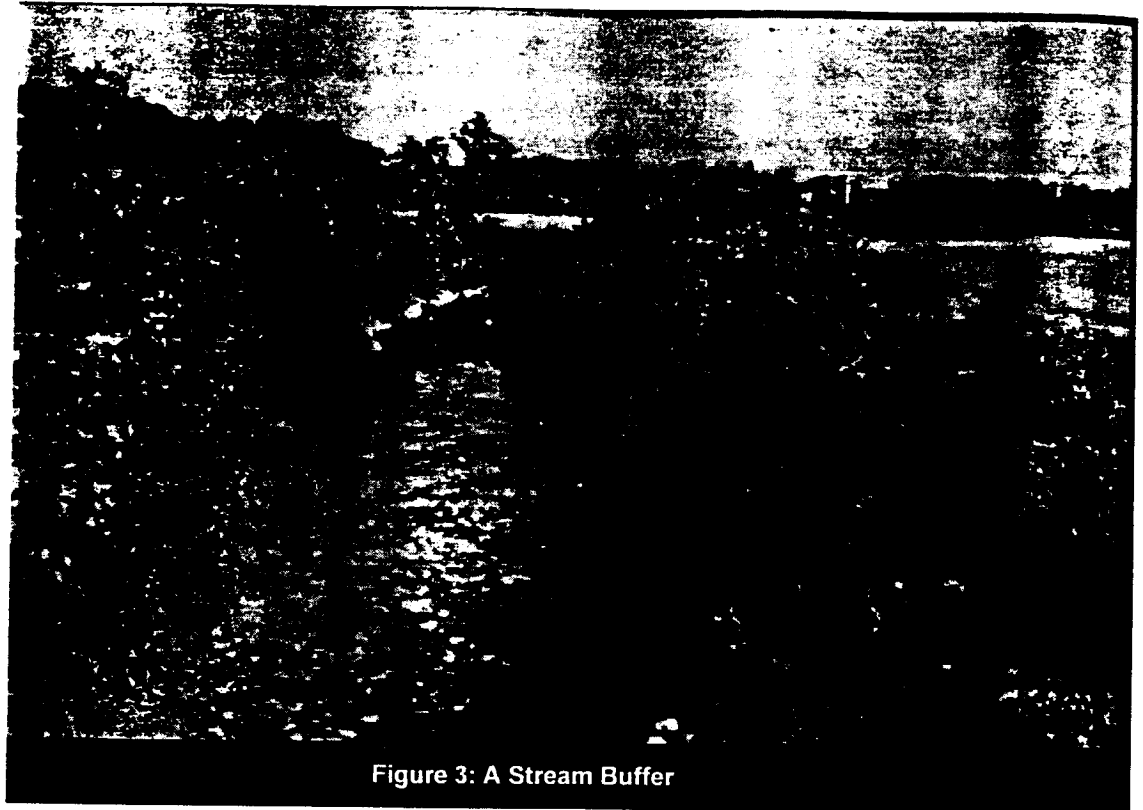

Figure 3: A Stream Buffer

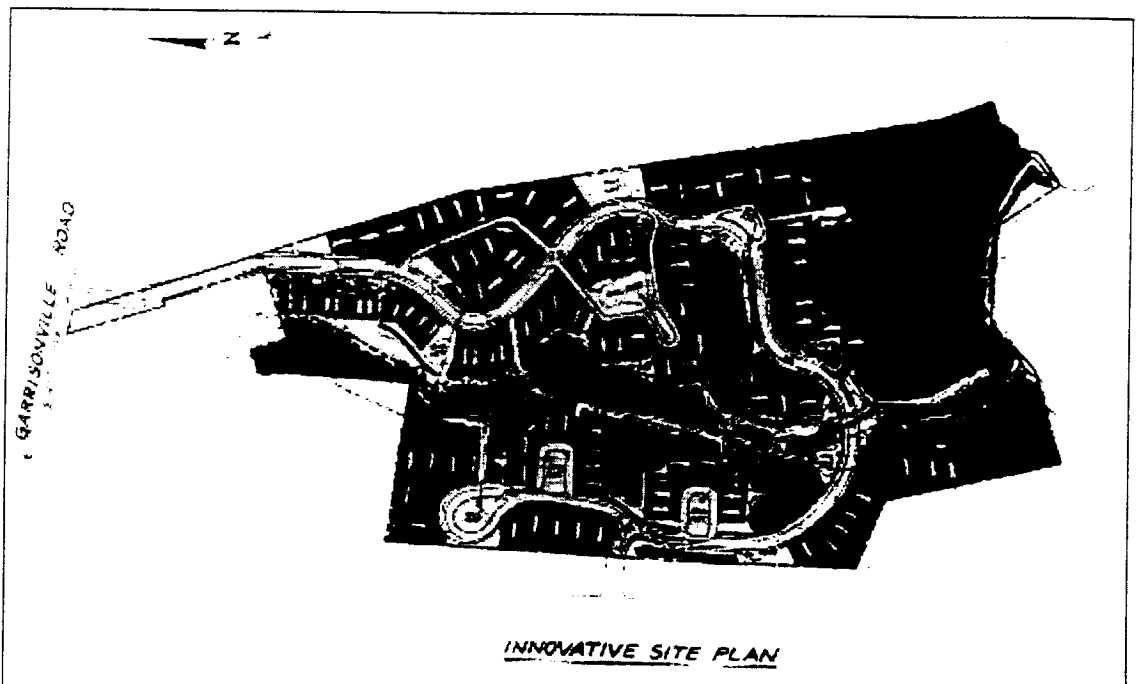

Figure 4: An Innovative Site Plan

In this design, stormwater pollutant loading was reduced by 40%, and the cost of development was reduced by 20% compared to a conventional site.

R0079589





- What incentives can be used to promote stewardship of private lands?
- Is a land trust available to accept and manage conservation areas, or does one need to be created?
- What are the most appropriate techniques to conserve land in the watershed?
- At what scale and by what method should conservation areas be delineated?

### Tool #3: Aquatic Buffers

The aquatic corridor, where land and water meet, deserves special protection in the form of buffers (Figure 3). A buffer can be placed along a stream or shoreline or around a natural wetland. A buffer has many uses and benefits. Its primary use is to physically protect and separate a stream, lake or wetland channel from future disturbance or encroachment. For streams, a network of buffers acts as a right-of-way during floods and sustains the integrity of stream ecosystems and habitats. Technically, a buffer is one type of land conservation area, but its functional importance in watershed protection merits some discussion on how they work and why they are important.

In some settings, buffers can remove pollutants traveling in stormwater or groundwater. Shoreline and stream buffers situated on flat soils have been found to be effective in removing sediment, nutrients, and bacteria from stormwater runoff and septic system effluent in a wide variety of rural and agricultural settings along the East Coast (Desbonnet *et al.*, 1994). While the benefits of buffers in urban areas are impressive, their capability to remove urban stormwater pollutants is often limited. Urban runoff concentrates rapidly on paved and hard packed turf surfaces and crosses the buffer as channel flow, effectively short circuiting the buffer. Buffers can also provide wildlife habitat and recreation. In many regions of the nation, the benefits of a buffer are amplified if it is managed in a forested condition.

The ability of buffers to actually realize the many potential benefits depends on how well the buffer is planned, designed and maintained. Buffers are important because they make up an integral part of the watershed protection strategy and complement other programs and efforts to protect critical receiving water quality.

#### Key Buffer Choices for the Watershed Manager

When applying the buffer tool, a watershed manager must make some careful choices about which kind of buffers are needed and how wide they must be. In many cases, a new buffer ordinance may need to be adopted or an old one revised to establish an effective buffer network within a subwatershed.

A watershed manager faces many tough questions when designing a buffer program for a subwatershed. Some issues that should be addressed include:

- How much of the aquatic corridor can be protected by buffers in my subwatershed?
- How should buffers be managed and crossed?
- Is restoration or better stewardship possible along an aquatic corridor that has already been developed?
- Will the buffer network be managed as a recreational greenway or as a conservation area in my subwatershed?
- Who will own and maintain the buffer and how will maintenance be paid for?
- How much pollutant removal can realistically be expected from my buffer network?

### Tool #4: Better Site Design

Individual development projects can be designed to reduce the amount of impervious cover they create, and increase the natural areas they conserve. Many innovative site planning techniques have been shown to sharply reduce the impact of new development (see Figure 4). Designers, however, are often not allowed to use these techniques in many communities because of outdated local zoning, parking or subdivision codes.

Thus, the fourth watershed protection tool seeks to foster better site designs that can afford greater protection to a subwatershed. The Center for Watershed Protection has recently developed a guidance manual entitled *Better Site Design: A Handbook for Changing Development Rules in Your Community* (CWP, 1998a) that helps watershed managers identify the local development rules that need to be changed to promote better site designs.

Four better design strategies that have special merit for subwatershed protection include:

1. Open space residential subdivisions
2. Green parking lots
3. Headwater streets
4. Rooftop runoff management

#### Open Space or Cluster Residential Subdivisions

Cluster development designs minimize lot sizes within a compact developed portion of a property while leaving the remaining portion open. Housing can still be detached single family homes as well as multi-family housing or a mix of both. Clustered development creates protected open space that provides many environmental as well as market benefits. Cluster or open space development design typically keeps 30 to 80% of the total site area in permanent community open space with much of the open space managed as natural area.

The key benefit of open space or cluster develop-

R0079590

ment is that it can reduce the amount of impervious cover created by a residential subdivision by 10 to 50% (CWP, 1998b; DE DNREC, 1997; Dreher and Price, 1994; Maurer, 1996; SCCCL, 1995). Clustering can also provide many community and environmental benefits. It can eliminate the need to clear and grade 35 to 60% of the total site area and can reserve up to 15% of the site for active or passive recreation. When carefully designed, the recreation space can promote better pedestrian movement, a stronger sense of community space, and a park-like setting. Numerous studies have confirmed that housing lots situated near greenways or parks sell for a higher price than more distant homes. Open space designs provide developers some "compensation" for lots that would otherwise have been lost due to wetland, floodplain, or other requirements. This, in turn, reduces the pressure to encroach on buffers and other natural areas. In addition, the ample open spaces within a cluster development provide a greater range of locations for more cost-effective stormwater runoff practices.

**Green Parking Lots**

When viewed from the air, parking lots are usually the largest feature of a commercial area, at least in terms of surface area. Over time, local parking codes have evolved to ensure that all workers, customers and residents have convenient and plentiful parking. In this respect, local parking codes have been a great success. One by-product, however, has been the creation of large expanses of often needless impervious cover.

A key strategy to reduce impervious cover involves the construction of green parking lots. Green parking refers to an approach that downsizes parking areas while still providing convenient access for the motorist. Green parking can be achieved through careful design and a comprehensive revision of local parking codes. The common theme in green parking lots is minimization of impervious area at every stage of parking lot planning and design.

**Headwater Streets**

Since streets are one of the biggest components of impervious cover created by car transport needs, headwater streets are built on a revised classification system where street width declines with decreasing average daily trips (much like headwater streams which decrease in size with decreasing drainage area). This is essential, since streets are a key source area for stormwater pollutants and do not allow the natural infiltration of water into the ground. By revisiting and changing some local subdivision codes many of the traditionally accepted standards can be changed to address this issue.

**Rooftop Runoff Management**

Re-directing rooftop runoff over pervious surfaces before it reaches paved surfaces can decrease the annual

runoff volume from a site by as much as 50% for medium to low density residential land uses (Pitt, 1987). This can significantly reduce the annual pollutant load and runoff volume being delivered to receiving waters and therefore can have a substantial benefit in reducing downstream impacts.

**Key Site Design Choices for the Watershed Manager**

When using the better site design tool, a watershed manager should be realistic about how much impervious cover can be reduced through better site design in a subwatershed. While better site designs can reduce the impact of individual development projects, the cumulative impact of too much development can still degrade some subwatersheds, no matter how well each one is designed. The value of the site design tool appears to be greatest in those subwatersheds that are approaching their maximum impervious cover limit.

A watershed manager needs to make some careful choices on how to best promote better site designs within a subwatershed. Some questions include:

- Will better site design really make a difference in reducing the growth of impervious cover in the sub-watershed?
- What are the most important development rules that need to be changed to promote better site design, and can a local consensus be achieved to actually change them?
- What economic and other incentives can be used to encourage developers to utilize better site designs?
- What is the time frame for revising codes and ordinances in the context of watershed planning?

**Tool #5: Erosion & Sediment Control**

Perhaps the most destructive stage of the development cycle is the relatively short period when vegetation is cleared and a site is graded to create a buildable landscape. The potential impacts to receiving waters are particularly severe at this stage. Trees and topsoil are removed, soils are exposed to erosion, natural topography and drainage patterns are altered, and sensitive areas are often disturbed. A combination of clearing restrictions, erosion prevention and sediment controls, coupled with a diligent plan review and strict construction enforcement are needed to help mitigate these impacts. Many communities rely primarily on sediment control as the primary strategy for sediment loss, though increasingly, the value of non-structural practices for erosion prevention are being recognized (Brown and Caraco, 1997).

Thus, the fifth watershed protection tool seeks to reduce sediment loss during construction and to ensure that conservation areas, buffers, and forests are not cleared or otherwise disturbed during construction.

### Key Erosion and Sediment Control Choices for the Watershed Manager

Every community should have an effective erosion and sediment control (ESC) program to reduce the potentially severe impacts generated by the construction process. The watershed manager should play a key role in defining which specific ESC practices need to be applied within the subwatershed to best protect sensitive aquatic communities, reduce sediment loads, and maintain the boundaries of conservation areas and buffers.

Some of the key decisions that watershed managers often make at the subwatershed level include:

- Is a higher level of ESC practice or more frequent inspection needed to protect my subwatershed?
- How well do current ESC programs reinforce other watershed protection tools, such as buffers, conservation areas, and better site design?

- What incentives can be used to minimize the amount of clearing at development sites?

### Tool#6: Stormwater Treatment Practices

A watershed manager needs to make careful choices about what stormwater treatment practices need to be installed in the subwatershed to compensate for the hydrological changes caused by new and existing development. The key choice is to determine what are the primary stormwater objectives for a subwatershed that will govern the selection, design and location of stormwater practices at individual development sites. While the specific design objectives for stormwater practices are often unique to each subwatershed, the general goals for stormwater management are often the same:

- Maintain groundwater recharge and quality
- Reduce stormwater pollutant loads
- Protect stream channels



Open Channel



Stormwater Pond



Stormwater Wetland



Stormwater Filter

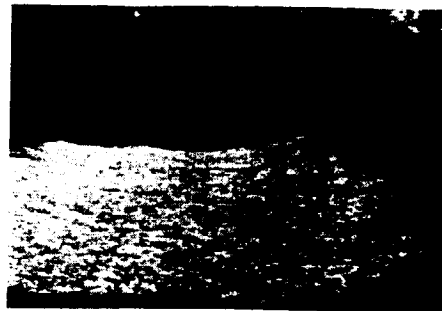

Infiltration Trench

Figure 5: Examples of Stormwater Management Practices

R0079592

- Prevent increased overbank flooding
- Safely convey extreme floods

Stormwater treatment practices are used to delay, capture, store, treat or infiltrate stormwater runoff. There are five broad groups of structural stormwater management practices:

- Ponds
- Wetlands
- Infiltration
- Filtering systems
- Open channels

Some examples of these are provided in Figure 5.

While many advances have been made recently in innovative stormwater practice designs, their ability to maintain resource quality in the absence of the other watershed protection tools is limited (Horner *et al.*, 1996). In fact, stormwater practices designed or located improperly can cause more secondary environmental impacts than if they were not installed at all.

#### Key Stormwater Choices for the Watershed Manager

Selecting the best stormwater practice can be a real challenge for the watershed manager. Some of the important issues and questions that watershed managers should address include the following:

- What is the most effective mix of structural vs. non-structural stormwater practices that can meet my subwatershed goals?
- Which hydrologic variables do we want to manage in the subwatershed (recharge, channel protection, flood reduction, etc.)?
- What are the primary stormwater pollutants of concern (phosphorus, bacteria, sediment, metals, hydrocarbons, or trash and debris)?
- What are the best stormwater practices for removing pollutants?
- Which stormwater practices should be used or avoided in the subwatershed because of their environmental impacts?
- What is the most economical way to provide stormwater management?
- Which stormwater practices are the least burdensome to maintain within local budgets?

#### Tool #7. Non-Stormwater Discharges

This tool concerns itself with how wastewater and other non-stormwater flows are treated and discharged in a watershed. In some watersheds, non-stormwater discharges can contribute significant pollutant loads to receiving waters. Key program elements consist of inspections of private septic systems, repair or replacement of failing systems, utilizing more advanced on-site septic

controls, identifying and eliminating illicit connections from municipal stormwater systems, and spill prevention.

Three basic kinds of non-stormwater discharges are possible in a subwatershed. Most non-stormwater discharges are strictly governed under the National Pollutant Discharge Elimination System (NPDES), and require a permit.

1. **Septic systems** (on-site sewage disposal) are used to treat and discharge wastewater from toilets, wash basins, bathtubs, washing machines, and other water-consumptive items that can be sources of high pollutant loads. One out of four homes in the country uses a septic system, collectively discharging a trillion gallons of wastewater annually (NSFC, 1995). Because of their widespread use and high volume discharges, septic systems have the potential to pollute groundwater, lakes and streams if located improperly or if they fail. Even properly functioning septic systems can be a substantial source of nutrient loads in some settings. Unlike other non-stormwater discharges, septic systems are not regulated under NPDES, but are approved by local and state health agencies.

2. With **sanitary sewers**, wastewater is collected in a central sewer pipe and sent to a municipal treatment plant. Ideally, this permits more efficient collection of wastewater, and often higher levels of pollutant reduction. The extension of sanitary sewer lines is not without some risk, as it has the potential to induce more development than may have been possible in a watershed that had been previously served only by on-site sewage disposal systems (particularly when soils are limiting). Most communities cannot refuse service to new development within the water and sewer envelope, so the decision to extend lines out into undeveloped areas allows future developers to tap into the line.

In addition, not all sanitary sewer conveyance and treatment systems are capable of achieving high levels of pollutant reduction. Examples include the following:

- Package treatment plants
- Combined sewer overflows
- Sanitary sewer overflows
- Illicit or illegal connections to the storm drain network

3. Wastewater is not the only non-stormwater discharge possible in a watershed. A planner should also investigate whether other non-stormwater discharges are a factor in the subwatershed. Examples include the following:

- Industrial NPDES discharges
- Urban "return flows" (discharges caused by activities such as car washing and watering lawns)

- Water diversions
- Runoff from confined animal feeding lots

### Key Non-Stormwater Discharge Choices for the Watershed Manager

One of the first priorities for a watershed manager is to conduct a quick inventory of the nature and extent of non-stormwater discharges in the subwatershed. If non-stormwater discharges appear to be a problem, then a watershed manager may need to conduct a subwatershed survey. This usually involves a survey of the largest or most common wastewater discharges within the subwatershed, with a strong emphasis on how wastewater is actually conveyed within the subwatershed (i.e. sanitary sewer, septic systems, etc.).

Some issues to address for the non-stormwater discharges tool include the following:

- What, if any, regulating or permit programs can be utilized to improve compliance for the greatest discharges?
- Does it make sense to extend the water/sewer envelope into the watershed?
- Where will the sewer be located in relationship to the stream corridor?
- Are current permit limits adequate or is a higher level of treatment needed?
- Where will the discharge be located?
- What kind of criteria for properly locating septic systems should be required?
- What kind of septic system technology should be used?
- How will septic systems be inspected, cleaned and maintained?

### Tool #8: Watershed Stewardship Programs

Once a subwatershed is developed, communities still need to invest in ongoing watershed stewardship. The goal of watershed stewardship is to increase public understanding and awareness about watersheds, promote better stewardship of private lands, and develop funding to sustain watershed management efforts.

There are six basic programs that watershed managers should consider to promote a greater watershed stewardship:

- Watershed advocacy
- Watershed education
- Pollution prevention
- Watershed maintenance
- Indicator monitoring
- Restoration

1. **Watershed Advocacy:** Promoting watershed advocacy is important because it can lay the foundation for public support and greater watershed stewardship. One of the most important investments that can be made in a watershed is to seed and support a watershed management structure to carry out the long-term stewardship function. Often, a grass roots watershed management organization is uniquely prepared to handle many critical stewardship programs, given their watershed focus, volunteers, low cost and ability to reach into communities. Watershed organizations can be forceful advocates for better land management and can develop broad popular support and involvement for watershed protection. Local government also has an important role to play in watershed advocacy. In many watersheds, local governments create or direct the watershed management structure.

2. **Watershed Education:** A basic premise of watershed stewardship is that we must learn two things: that we live in a watershed and that we understand how to live within it. The design of watershed education programs that create this awareness is of fundamental importance. The four elements of watershed education are as follows:

- **Watershed awareness:** raising basic watershed awareness through signage, storm drain stenciling, streamwalks, maps
- **Personal stewardship:** educating residents about the individual role they play in the watershed and communicating specific messages about positive and negative behaviors
- **Professional training:** educating the development community on how to apply the tools of watershed protection
- **Watershed engagement:** providing opportunities for the public to actively engage in watershed protection and restoration

3. **Pollution Prevention:** Some watershed businesses may need special training on how to manage their operations to prevent pollution and thereby protect the watershed. In some cases, local or state government may have a regulatory responsibility to develop pollution prevention programs for certain businesses and industrial categories (e.g., under industrial or municipal NPDES stormwater permits).

4. **Watershed Maintenance:** Most watershed protection tools require maintenance if they are to properly function over the long run. Some of the most critical watershed "maintenance" functions include management of conservation areas and buffer networks, and maintenance of stormwater practices, septic systems and sewer networks.

5. **Watershed Indicator Monitoring:** An ongoing stewardship responsibility is to monitor key indicators to track the health of the watershed. Public agencies should seriously consider citizen monitoring to provide high quality and low cost indicator data.



R0079594

6. **Watershed Restoration:** The last phase of watershed stewardship is to restore or at least rehabilitate streams that have been degraded by past development. Urban watershed restoration is an emerging art and science that seeks to remove pollutants and enhance habitat to restore urban streams. The urban watershed restoration process should include three main themes: stormwater retrofitting, source control through pollution prevention, and stream enhancement (Claytor, 1995).

#### Key Choices for the Watershed Manager

There are several important issues that watershed managers should address when designing watershed stewardship programs:

- Is my community ready to undertake restoration?
- Which mix of stewardship programs is best for my subwatershed?
- Who are the best targets for watershed education?
- How am I going to pay for a stewardship program?

#### Summary

This article provides a simple introduction to the eight watershed protection tools. For more information on how to implement these tools, refer to other articles in this book.

#### References

- Brown, W. and Caraco, D. 1997. "Muddy Water In, Muddy Water Out." *Watershed Protection Techniques*. 2(3): 393-404.
- Center for Watershed Protection (CWP). 1998a. *Better Site Design: A Handbook for Changing Development Rules in Your Community*. Ellicott City, MD.
- Center for Watershed Protection (CWP). 1998b. *Nutrient Loading from Conventional and Innovative Site Development*. Prepared for the Chesapeake Research Consortium, Annapolis, MD.
- Claytor, R. 1995. "Assessing the Potential for Urban Watershed Restoration." *Watershed Protection Techniques*. 1(4): 166-172.
- Delaware Department of Natural Resources and Environmental Conservation (DE DNREC). 1997. *Conservation Design for Stormwater Management*. Delaware Department of Natural Resources and Environmental Conservation, Dover, DE.
- Desbonnet, Alan, Pamela Pogue, Virginia Lee, and Nicholas Wolff. 1994. *Vegetated Buffers in the Coastal Zone: A Summary Review and Bibliography*. Coastal Resources Center, Rhode Island Sea Grant, Narragansett, RI.
- Dreher, D. and T. Price. 1994. *Reducing the Impact of Urban Runoff: The Advantages of Alternative Site Design Approaches*. Northeastern Illinois Planning Commission, Chicago IL.
- Horner, et al. 1996. "Watershed Determinates of Ecosystem Functioning." *Effects of Watershed Development and Management on Aquatic Ecosystems*. Roesner, L.A. (editor). Snowbird Utah. August 4-9, 1996. Engineering Foundation.
- Montgomery County (Maryland) Department of Environmental Protection (MCDEP). 1998. *Countywide Stream Protection Strategy*. Montgomery County Department of Environmental Protection and Maryland-National Capital Park and Planning Commission.
- Maurer, George. 1996. *A Better Way to Grow: For More Livable Communities and a Healthier Chesapeake Bay*. Chesapeake Bay Foundation, Annapolis, MD.
- National Small Flows Clearinghouse (NSFC). *Pipeline* 6(3), 1995.
- Nelson, M. 1998. Personal Communication. Horsley and Witten, Inc. Sandwich, MA.
- Pitt, R. 1987. *Small Storm Urban Flow and Particulate Washoff Contributions to Outfall Discharges*. Doctorate Thesis, University of Wisconsin, Madison, WI.
- Pitt, R. 1993. *Source Loading and Management Model (SLAMM)*. National Conference on Urban Runoff Management, March 30-April 2, 1993. Chicago, IL.
- Schueler, T. 1995. *Site Planning for Urban Stream Protection*. Center for Watershed Protection, Ellicott City, Maryland.
- South Carolina Coastal Conservation League (SCCCL). Fall 1995. "Getting a Rein on Runoff: How Sprawl and Traditional Town Compare." *SCCCL Land Development Bulletin* (7). South Carolina Coastal Conservation League, Charleston, SC.

R0079595

# Article 28

Chapter 1 from *The Rapid Watershed Planning Handbook*

## Basic Concepts in Watershed Planning

This article introduces some of the basic watershed concepts that are at the heart of the rapid watershed planning approach. It is helpful to fully understand these concepts before embarking on a local watershed plan.

**Concept No. 1. There are many different watershed management units.**

Watershed and subwatershed units are most practical for local plans. Each watershed is composed of many individual subwatersheds that can have their own unique water resource objectives. A watershed plan is a comprehensive framework for applying management tools within each subwatershed in a manner that also achieves the water resources goals for the watershed as a whole.

When developing a watershed plan, it is useful to consider how watersheds are configured. The term **management unit** is used to describe watersheds and their smaller segments. The two management units that will be focused upon in this discussion are the **watershed** and the **subwatershed**. A **watershed** can be defined as the land area that contributes runoff to a particular point along a waterway. A typical watershed can cover tens to hundreds of square miles and several jurisdictions.

Watersheds are broken down into smaller geographic units called **subwatersheds**. Subwatersheds typically have a drainage area of two to 15 square miles

with boundaries that include the land area draining to a point at or below the confluence of two second order streams and almost always within the limits of a third order stream. While management unit size will vary among geographic regions and also as a function of slope, soils and degree of urbanization, this general definition provides a consistent and uniform basis for defining individual subwatershed boundaries within a larger watershed.

The terms "watershed" and "subwatershed" are *not* interchangeable. The term **watershed** is used when referring to broader management issues across an entire watershed, while the term **subwatershed** is used to refer assessment level studies and specific projects within the smaller subwatershed units.

There are other important management units to consider when developing a watershed plan. The largest watershed management unit is the basin. A **basin** drains to a major receiving water such as a large river, estuary or lake. Basin drainage areas typically exceed several thousand square miles and often include major portions of a single state or even a group of states. Within each basin are a group of **sub-basins** that extend over several hundred square miles. Sub-basins are a mosaic of many diverse land uses, including forest, agriculture, range, and urban areas. Sub-basins are composed of a group of watersheds, which, in turn, are composed of a group of subwatersheds. Within subwatersheds are **catchments**, which are the smallest units in a watershed. A **catchment** is defined as the area that drains an individual development site to its first intersection with a stream.

Table 1: Description of the Various Watershed Management Units

Watershed Management Unit	Typical Area	Influence of Impervious Cover	Sample Management Measures
Catchment	50 to 500 acres	very strong	practices and site design
Subwatershed	1 to 10 square miles	strong	stream classification and management
Watershed	10 to 100 square miles	moderate	watershed-based zoning
Subbasin	100 to 1,000 square miles	weak	basin planning
Basin	1,000 to 10,000 square miles	very weak	basin planning

R0079596



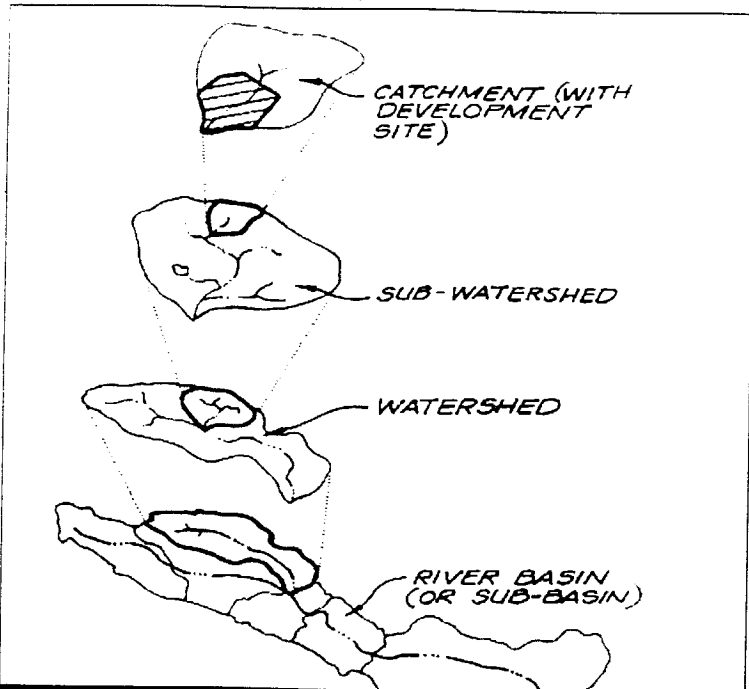

Figure 1: The Watershed Management Units  
(Clements *et al.*, 1996)

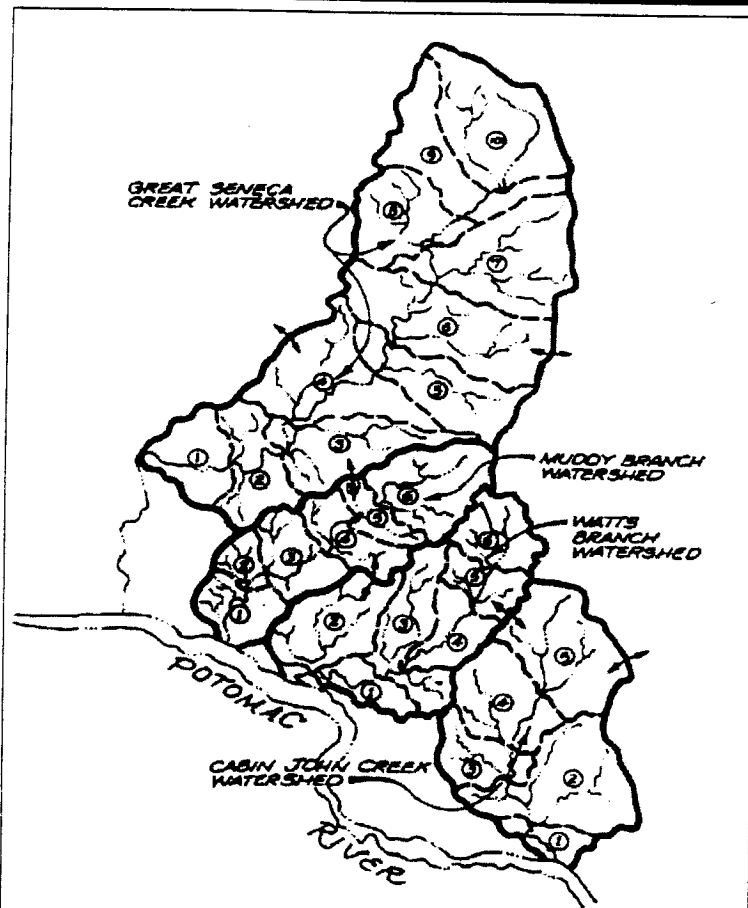

Figure 2: Four Watersheds Containing 27  
Subwatersheds (MCDEP, 1998)

Table 1 describes the various management units and provides a comparison of impervious cover influences and possible management measures. Figure 1 illustrates how watershed management units nest together within the drainage system.

A local watershed may have dozens of individual subwatersheds within its boundaries. A watershed plan tracks the planning and management within individual subwatersheds. Figure 2 illustrates this concept of multiple subwatersheds within a larger watershed.

This article focuses on the subwatershed as the primary planning unit for several reasons:

- The influence of impervious cover on hydrology, water quality, and biodiversity is most evident at the subwatershed level where the influences of individual development projects are easily recognizable.
- Subwatersheds are small enough to be within just a few political jurisdictions where it is easier to establish a clear regulatory authority and incorporate the smaller number of stakeholders into the management process.
- Subwatersheds are limited so that few confounding pollutant sources (e.g., agricultural runoff, point sources, etc.) are present that confuse management decisions.
- A map of a subwatershed can usually fit on a standard 24 by 36 foot sheet with sufficient detail to provide useful management information.
- Locally, managers may prefer the subwatershed as a planning unit because it is small enough to perform monitoring, mapping, and other watershed assessment tasks in a rapid time frame. A subwatershed plan can generally be completed within a year's time and still allow ample time for goal development, agency coordination, and stakeholder involvement. This shorter time span enables planners to generate many subwatershed plans in a consistent and coordinated cycle.

**Concept No. 2. Each subwatershed contains a network of small streams channels that are known as headwater streams.**

While each headwater stream is short and narrow, they collectively represent a majority of the drainage network of any watershed management unit. Consequently, it makes sense to focus on headwater streams in any watershed plan.

Stream classification is important in watershed management. It is also important to understand the spatial connections between the stream and its watershed. A network of streams drain each watershed.



Streams can be classified according to their order in that network. A stream that has no tributaries or branches is defined as a first-order stream. When two first-order streams combine, a second-order stream is created, and so on. **Headwater streams** are defined as first- and second-order streams. Figure 3 illustrates the stream order concept.

Headwater streams are the smallest streams but they are crucial in watershed management because they dominate the landscape through their sheer number and cumulative length. Figure 4 illustrates the significance of a headwater stream network in a local landscape.

Headwater streams are typically short in length and drain relatively small areas, but are important because they comprise roughly 75% of the total stream and river mileage in the United States. Table 2 illustrates the proportion of smaller streams to larger streams in the United States.

What happens in the local landscape is directly translated to headwater streams and major receiving waters are affected in turn. As urbanization increases, streams handle increasing amounts of runoff which degrades headwater streams as well as major tributaries.

Focusing on the headwater stream level is important in watershed management for several reasons:

- Streams are exceptionally vulnerable to watershed changes
- Streams are on the same scale as development
- The public intuitively understands streams and strongly supports their protection
- Streams are the "narrowest door" for water resource protection
- Streams are good indicators of watershed quality

The watersheds and subwatersheds that drain to these streams are "readily identifiable landscape units that integrate terrestrial, aquatic, geologic, and atmospheric processes" (Clements *et al.*, 1996). They are the most appropriate geographic unit to protect water resources.

**Concept No. 3. Recent research has shown that the amount of impervious cover in a subwatershed can be used to project the current and future quality of many headwater streams.**

There are also strong lines of evidence that suggest that impervious cover is linked to the quality of other subwatershed resources such as lakes, reservoirs, estuaries and aquifers.

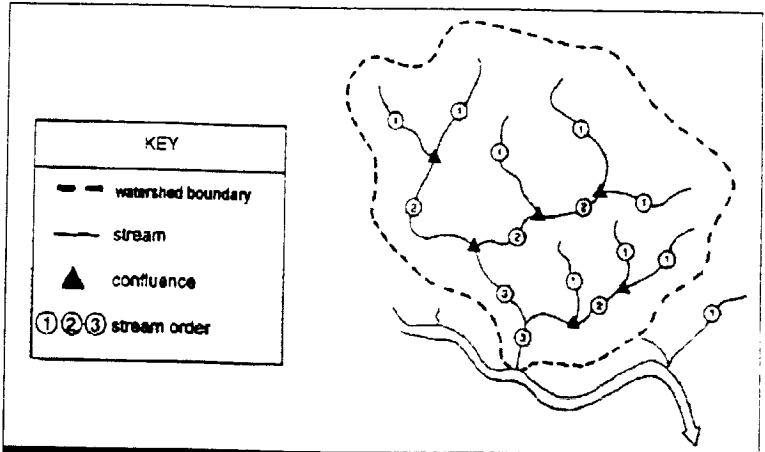

**Figure 3: A Network of Headwater and Third-Order Streams**

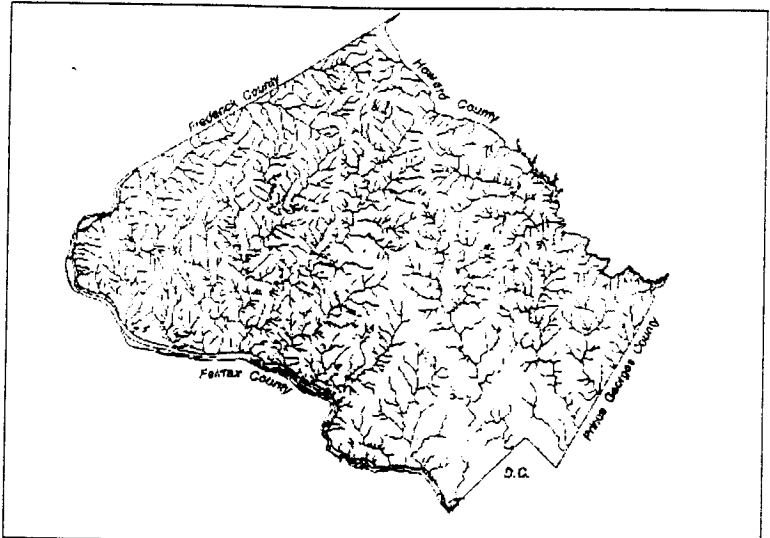

**Figure 4: An Example of a Stream Network (MCDEP, 1998)**

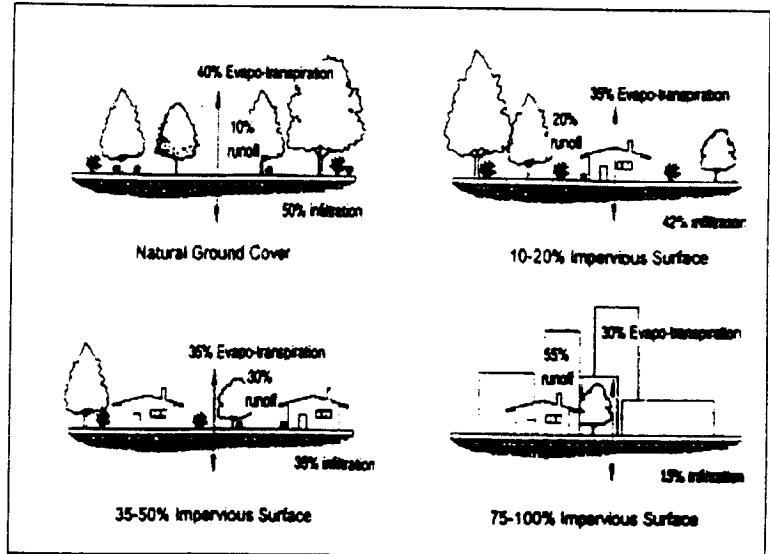

**Figure 5: The Impact of Impervious Surface Changes on the Annual Water Balance (PGDER, 1997)**

### *The Influence of Impervious Cover on Stream Quality*

The conversion of farmland, forests, wetlands, and meadows to rooftops, roads, and lawns creates a layer of impervious surface in the urban landscape. Impervious cover is a very useful indicator with which to measure the impacts of land development on aquatic systems. The process of urbanization has a profound influence on the hydrology, morphology, water quality, and ecology of surface waters (Horner *et al.*, 1996). Recent research has shown that streams in urban watersheds possess a fundamentally different character than streams in forested, rural, or even agricultural watersheds. The amount of impervious cover in the watershed can be used as an indicator to predict how severe these differences can be. In many regions of the country, as little as 10% watershed impervious cover has been linked to stream degradation, with the degradation becoming more severe as impervious cover increases (Schueler, 1994).

Impervious cover directly influences urban streams by dramatically increasing surface runoff during storm events. Depending on the degree of impervious cover, the annual volume of stormwater runoff can increase by two to 16 times its predevelopment rate, with proportional reductions in groundwater recharge (Schueler, 1994). Figure 5 illustrates the influence of impervious cover on the hydrologic cycle and the amount of infiltration which occurs. In natural settings, very little annual rainfall is converted to runoff and about half is infiltrated

into the underlying soils and the water table. This water is filtered by the soils, supplies deep water aquifers, and helps support adjacent surface waters with clean water during dry periods. In urbanized areas, less and less annual rainfall is infiltrated and more and more volume is converted to runoff. Not only is this runoff volume greater, it also occurs more frequently and at higher magnitudes. As a result, less water is available to streams and waterways during dry periods and more flow occurs during storms.

Other key changes in urban streams due to increases in impervious cover levels are detailed below:

*Bankfull and sub-bankfull floods increase in magnitude and frequency.* The peak discharge associated with the bankfull flow (i.e., the 1.5 to two-year return storm) increases sharply in magnitude in urban streams. In addition, channels experience more bankfull and sub-bankfull flood events each year, and are exposed to critical erosive velocities for longer intervals (Hollis, 1975; Booth *et al.*, 1996; and MacRae, 1996).

*Dimensions of the stream channel are no longer in equilibrium with its hydrologic regime.* The hydrologic regime that had defined the geometry of the predevelopment stream channel irreversibly changes and the channel faces higher flow rates on a more frequent basis. The higher flow events of the urban stream are capable of performing more "effective work" in moving sediment than they had done before (Wolman, 1954).

**Table 2: Proportion of National Stream and River Mileage in Headwater Streams (Leopold *et al.*, 1964)**

Stream Order*	Number of Streams	Total Length of Stream (miles)	Mean Drainage Area (square miles)**
1	1,570,000	1,570,000	1.0
2	350,000	810,000	4.7
3	80,000	420,000	23
4	18,000	220,000	109
5	4,200	116,000	518
6	950	61,000	2,460
7	200	30,000	11,700
8	41	14,000	55,600
9	8	6,200	264,000
10	1	1,800	1,250,000
Total	2,023,400	3,250,000	N/A

\* stream order based on Strahler (1957) method, analyzing maps at a scale of 1:24,000  
 \*\* cumulative drainage area, including tributaries

*Channels enlarge.* The customary response by an urban stream is to increase its cross-sectional area to accommodate the higher flows. This is done by stream bed down-cutting, stream bank widening, or a combination of both. Urban stream channels often enlarge their cross-sectional area by a factor of two to five, depending on the degree of impervious cover and the age of development in the upland watershed (Arnold *et al.*, 1982; Gregory *et al.*, 1992; and MacRae, 1996).

*Stream channels are highly modified by human activity.* Urban stream channels are extensively modified in an effort to protect adjacent property from streambank erosion or flooding. Headwater streams are frequently enclosed within storm drains, while others are channelized, lined, and/or "armored" by heavy stone. Another modification that is unique to urban streams is the installation of sanitary sewers underneath or parallel to the stream channel. According to May *et al.* (1997), 20 to 30% of natural stream channels are modified in typical urban watersheds.

*Upstream channel erosion contributes greater sediment load to the stream.* The prodigious rate of channel erosion in urban streams, coupled with sediment erosion from active construction sites, increases sediment discharge to urban streams. Researchers have documented that channel erosion constitutes as much as 75% of the total sediment budget of urban streams (Crawford and Lenat, 1989; Trimble, 1997). Urban streams also tend to have a higher sediment discharge than non-urban streams during the active channel enlargement stage.

*Dry weather flow in the stream declines.* Since impervious cover prevents rainfall from infiltrating into the soil, less flow is available to recharge groundwater. Consequently, during extended periods without rainfall, baseflow levels are often reduced in urban streams (Simmons and Reynolds, 1982).

*Wetted perimeter of the stream during low flow declines.* The wetted perimeter of a stream is the fraction of the total cross-sectional area of the channel that is covered by flowing water during dry-weather periods, and is an important indicator of habitat degradation in urban streams. Given that urban streams develop a larger channel cross-section while their baseflow rates decline, it follows that the wetted perimeter becomes smaller. Thus, for many urban streams, this results in a very shallow low flow channel that "wanders" across a very wide stream bed, often changing its lateral position in response to storms.

*Instream habitat structure degrades.* Urban streams are routinely scored as having poor instream habitat quality, regardless of the specific metric or method employed. Habitat degradation is often exemplified by a loss of pool and riffle structure, embedding of stream bed sediments, shallow depths of flow, eroding and unstable banks, and frequent stream bed turnover.

*Large woody debris is reduced (LWD).* Large woody debris is an important structural component of many low order streams systems, creating complex habitat structure and generally making the stream more retentive. In urban streams, the quantity of LWD found in stream channel declines sharply, due to the loss of riparian forest cover, storm washout, and channel maintenance practices (Booth *et al.*, 1996; May *et al.*, 1997).

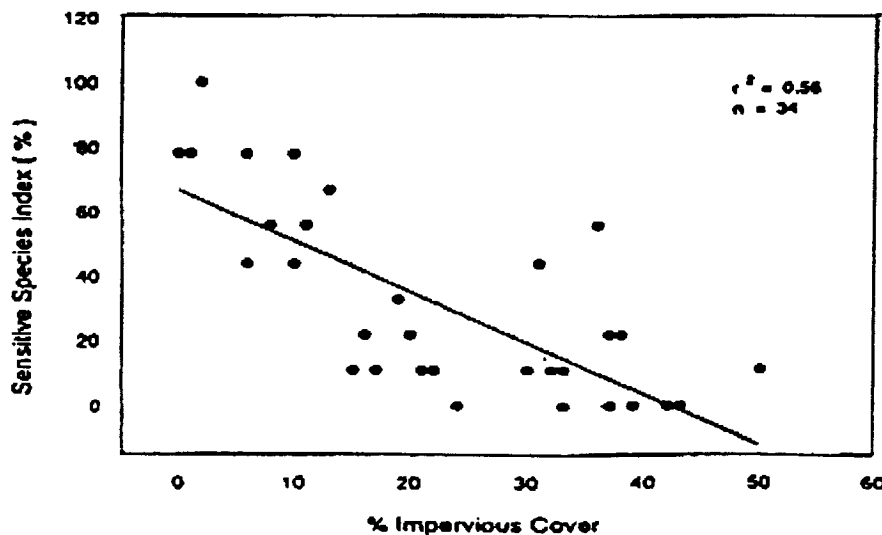

Figure 6: Relationship Between Impervious Cover and the Sensitive Aquatic Insect Index in Delaware's Northern Piedmont Streams (Maxted and Shaver, 1996)

R0079600

*Stream crossings and potential fish barriers increase.* Many forms of urban development are linear in nature (e.g., roads, sewers, and pipelines) and cross stream channels. The number of stream crossings increases directly in proportion to impervious cover (May *et al.*, 1997), and many crossings can become partial or total barriers to upstream fish migration, particularly if the stream bed erodes below the fixed elevation of a culvert or a pipeline.

*Riparian forests become fragmented, narrower and less diverse.* The important role that riparian forests play in stream ecology is often diminished in urban watersheds, as tree cover is often partially or totally removed along the stream as a consequence of development (May *et al.*, 1997). Even when stream buffers are reserved, encroachment often reduces their effective width, and native species are supplanted by exotic trees, vines and ground covers.

*Water quality declines.* The water quality of urban streams during storm events is consistently poor. Urban stormwater runoff contains moderate to high concentrations of sediment, carbon, nutrients, trace metals, hydrocarbons, chlorides and bacteria (Schueler, 1987). While considerable debate exists as to whether stormwater pollutant concentrations are actually toxic to aquatic organisms, researchers agree that pollutants deposited in the stream bed exert an undesirable impact on the stream community.

*Summer stream temperatures increase.* The impervious surfaces, ponds, and poor riparian cover found in urban watersheds can increase mean summer stream temperatures by two to 10 degrees Fahrenheit (Galli, 1991). Since temperature plays a central role in the rate and timing of biotic and abiotic reactions in streams, even moderate increases can have an adverse impact on

streams. In some regions, summer stream warming can irreversibly shift a cold-water stream to a cool-water or even warm-water stream, with deleterious effects on salmonoids and other temperature sensitive organisms.

*Reduced aquatic diversity.* Urban streams are typified by fair to poor fish and macroinvertebrate diversity, even at relatively low levels of watershed impervious cover or population density. The ability to restore predevelopment fish assemblages or aquatic diversity is constrained by a host of factors: irreversible changes in carbon supply, temperature, hydrology, lack of instream habitat structure, and barriers that limit natural recolonization.

A typical relationship between impervious cover and the presence of sensitive aquatic insects from the Delaware Piedmont region is illustrated in Figure 6. As the level of impervious cover in the watershed increases, the amount of sensitive species declines. Beyond watershed imperviousness levels of 10 to 15%, about 90% of the sensitive organisms are lost from the stream (Maxted and Shaver, 1996).

In recent years, many studies have begun to quantify the relationship between development and the health of the receiving waters. In general, the studies point to a decrease in stream quality with increasing urbanization. Other measures may also have predictable relationships to stream quality, such as the quantity and quality of riparian cover, or the amount of compacted urban turf (Schueler, 1995).

#### *The Influence of Impervious Cover on Other Aquatic Systems*

The impact of impervious cover on the quality of lakes, water supply reservoirs, aquifers, or coastal areas has not been as well investigated as it has for

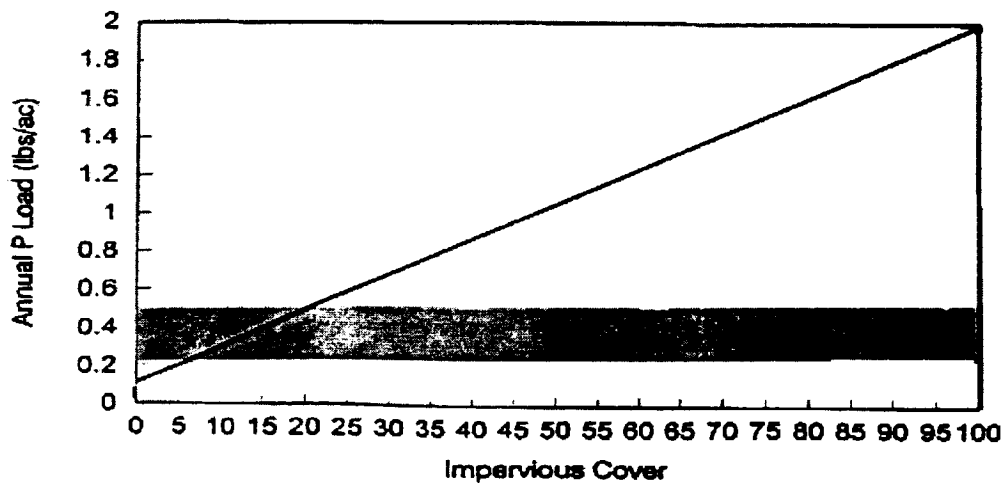

**Figure 7: Relationship Between Phosphorus Load and Impervious Cover**  
The gray band indicates typical "background" phosphorus loads from undeveloped watersheds

### Fecal Coliform Levels in Urban Stormwater: A National Review

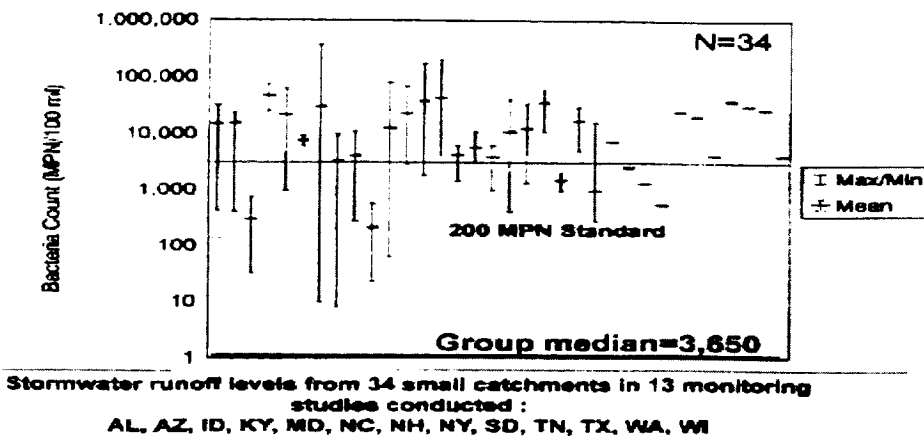

Figure 8: Fecal Coliform Levels in Urban Stormwater

urban streams. Although research is scarce, there is some evidence that impervious cover does have a similar impact on these aquatic systems. The impacts to these systems are manifested in different ways and may occur at different levels of impervious cover than are often seen for urban streams.

Even small increases in impervious cover change stream morphology and degrade aquatic habitat. In contrast, aquatic systems such as lakes, water supply reservoirs, aquifers, and coastal areas tend to be impacted more by a decline in water quality due to non-point source pollutants. Research has shown that stormwater pollutant loads increase when the percentage of impervious cover in a watershed increases.

#### Urban Lakes

For urban lakes, the major water quality impacts are caused by higher stormwater pollutant loads. Elevations in total phosphorus and chlorophyll *a* are often associated with the impervious cover generated in developing areas. These factors can negatively affect the quality of the lake for activities such as fishing, swimming, or other water contact recreation. Sediment inputs may also be heightened with additional development in the watershed, which can often affect water clarity. In addition, the natural level of the lake may also be affected by the increased stormwater runoff which occurs with changes in impervious cover levels in the watershed.

Research has shown that impervious cover may be strongly related to water quality in small urban lakes, where eutrophication is considered the primary measure of degradation (i.e., in nutrient-sensitive lakes). Some indication of the possible relationship is illus-

trated in Figure 7, which shows the urban phosphorus load as a function of impervious cover.

In this general model, post-development phosphorus loads exceed background loads in many lakes once watershed imperviousness exceeds 20 to 25% impervious cover. The use of effective stormwater practices can raise the phosphorus threshold to higher levels, but eventually an impervious cover level will be reached where predevelopment phosphorus levels can no longer be maintained.

The water quality of urban lakes is a very important issue due to its economic and health impacts. Many of the states in the upper Midwest region, such as Michigan and Minnesota, have programs designed to protect their important inland lake resources from rapid urban growth. Similar programs are being developed in Maine where a phosphorus allocation model is used to limit phosphorus export from new development to lake resources (Monagle, 1996). Other examples include Deal Lake, New Jersey where a lake commission is working with five watershed municipalities to upgrade watershed plans to prevent eutrophication and sedimentation (US EPA, 1995).

#### Water Supply Reservoir

While water supply reservoirs also experience the same impacts as urban lakes, the issue of public health and water quality is often a major concern. Of greatest concern is the fact that stormwater runoff from watersheds with very little impervious cover routinely exceeds state and federal standards for fecal coliform. This means that urbanizing watersheds must carefully plan to ensure the safety of public drinking water supplies. Excessive algal blooms may also occur with greater stormwater inputs, causing taste and odor problems and



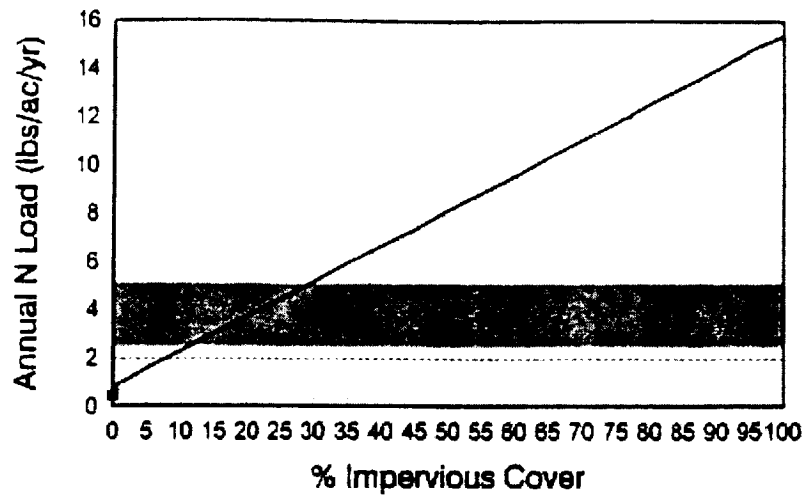

Figure 9: Relationship Between Nitrogen Load and Impervious Cover

formation of a cancer causing agent THM (Tri-Halo-Methanes). In addition, increased sediment inputs attributed to elevated levels of stormwater runoff have a two-fold impact on water supply reservoirs; first, turbidity of the water is negatively affected; and second, sedimentation can result in a loss in reservoir capacity. The input of certain metals (barium, copper, zinc, etc.) may also be enhanced by stormwater runoff levels.

When evaluating possible impacts to water supply reservoirs, it is important at this point to distinguish between filtered and unfiltered water supplies. In a filtered water supply reservoir, the water from the reservoir travels to a water treatment facility where chemical and physical processes are used to remove pollutants, eliminate bacteria, and ensure that the water is fit for human consumption. In an unfiltered water supply, the treatment of the water supply is more limited, with chlorination or UV irradiation being the usual forms of treatment. Thus the potential risk from fecal coliform bacteria and other pathogens is often greater in unfiltered water supply reservoirs.

Bacterial levels in urban stormwater runoff can be a major concern for water supply reservoirs. A national review of fecal coliform levels in urban stormwater indicates that urban runoff has bacteria levels which routinely exceed established health standards. Figure 8 demonstrates the results of a review of 13 urban watershed monitoring studies from around the country. For these watersheds, the mean level of fecal coliform is 18 times the recreational water contact standard. Several examples from around the country illustrate the growing concern over water quality and water supply reservoirs. For example, in North Carolina concerns over adequate protection of water supplies have led to changes in zoning and land use in both the Cane Creek and Univer-

sity Lake watersheds. In the Kensico Reservoir in New York, watershed protection programs are being implemented to protect water supplies and retain a "filtration avoidance" status. In Wachussetts, MA efforts are being made to protect the local water supply reservoir through watershed planning and stormwater practice implementation.

#### Coastal/Estuarine

The impacts to coastal/estuarine areas from impervious cover are numerous. Nitrogen inputs from stormwater runoff and non-structural discharges can have serious consequences due to increases in algal bloom occurrences. Increased inputs of metals, toxins, and hydrocarbons from urban runoff can directly affect the health of these important aquatic areas. Decreases in water quality due to pollutant loading may also have an adverse impact on valuable spawning habitat and anadromous fish passages. Additionally, high bacterial levels may result in contamination of shellfish beds, causing closures and economic impacts on fishing industries located in the watershed. Stormwater runoff may also have a physical effect on important wetland resources.

Research points to the strong influence of impervious cover on coastal/estuarine systems such as shellfish beds and wetlands (Duda and Cromartie, 1982; Hicks, 1995; Taylor, 1993). Interestingly, each study found degradation thresholds when impervious cover exceeded 10%. Impervious cover also has a direct effect on the levels of nitrogen entering into coastal and estuarine areas. Figure 9 illustrates the nature of this relationship. Nitrogen levels are an important consideration, since they are related to eutrophication in coastal/estuarine areas in the same way phosphorus is

an indicator of eutrophication for freshwater lakes.

Researchers from various parts of the country have sought to study the impact of urbanization on coastal areas and wetland resources. Reports from areas such as Tampa Bay, FL, Neuse River, NC, Puget Sound, WA and San Francisco Bay, CA all indicate that stormwater can be a significant source of pollutants to coastal areas and estuaries.

### Aquifers

Aquifers can be impacted by impervious cover in terms of both the quantity and quality of groundwater. Impervious cover decreases infiltration rates and allows more stormwater to be converted to runoff. The loss of this infiltration affects the quantity of water available to recharge an aquifer, as well as the rate of recharge. This reduced recharge rate may result in wells using the aquifer going dry as groundwater levels fall. Water quality in wells connected to aquifers is also a concern, since urban stormwater tends to have more pollutants and pathogens associated with it and may mean that drinking water standards are not being met. The aquifers in karst areas, where porous underlying layers allow for rapid infiltration of stormwater, are a major concern.

To our knowledge, no systematic research has been conducted to determine whether groundwater recharge or quality are predictably influenced as a function of impervious cover. It is speculated that such relationships will be complex and hard to detect, since groundwater recharge and quality are also influenced by septic systems, wells, lawn irrigation, and sewer inflow and infiltration. However, the impacts of impervious cover and its effect on dry weather stream flows have been studied. Several studies (Evet, 1994; Ferguson and Suckling, 1990) have observed that there were decreases in stream flow during dry weather periods which have been attributed to increases in urbanization. This decrease is a result of diminished groundwater recharge which lowers the water table and causes streamflows in urbanizing areas to fall below a predevelopment sustainable base flow. Figure 10 illustrates the effect of reduced groundwater recharge on streamflow.

Groundwater quality has been linked to impervious cover in several watersheds. For example, the Edwards Aquifer in Texas is a prime example of an urbanizing watershed in which runoff from increased development has affected water quality. Contamination of the Barton Springs segment of the Edwards Aquifer has been well documented. Several studies have found contaminant levels for some heavy metals in excess of the EPA maximum for drinking water. In addition, water quality studies for six streams which recharge Barton Springs have found that water quality is degrading with increased development. In the more

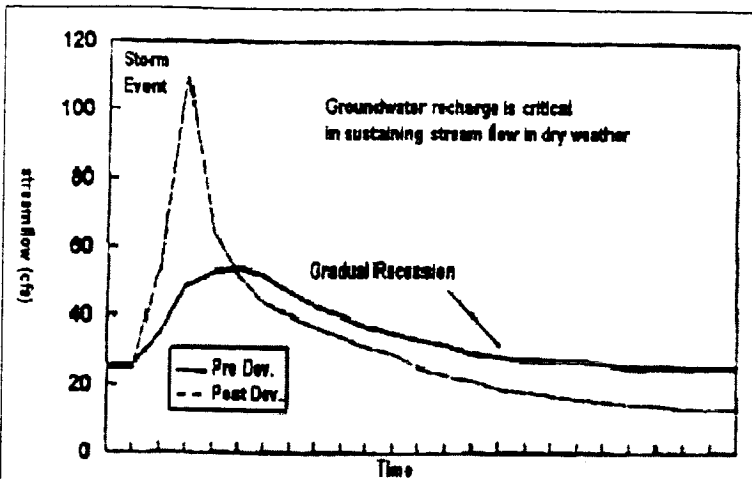

Figure 10: The Effect of Groundwater Recharge on Streamflow

developed lower reaches of Barton Creek, stormflow concentrations of contaminants such as nitrogen, phosphorus, and fecal coliform have been found to exceed values found in the upper reaches by several hundred percent or more.

This trend in decreasing groundwater quality has been found in a number of other areas of the country (Fulbright Springs, MO—WWE, 1995; Clarksville, TN—Hoos, 1990). This has led several local governments to implement watershed planning efforts to control stormwater runoff and associated contaminants. These efforts have often included controls on land use, and restrictions on development in order to cap the amount of impervious cover in the aquifer recharge area.

**Concept No. 4. The relationship between impervious cover and subwatershed quality can be predicted by a simple model that projects the current and future quality of streams and other water resources at the subwatershed level.**

It is important to understand the assumptions and limitations of the simple model before using it to develop individual subwatershed plans within a watershed.

#### *The Impervious Cover Model*

Stream research generally indicates that certain zones of stream quality exist, most notably at about 10% impervious cover, where sensitive stream elements are lost from the system. A second threshold appears to exist at around 25 to 30% impervious cover, where most indicators of stream quality consistently shift to a poor condition (e.g., diminished aquatic diversity, water quality and habitat scores).

R0079604

Taking all the research together, it is possible to construct a simple urban stream classification scheme based on impervious cover and stream quality. This simple classification system contains three stream categories, based on the percentage of impervious cover. Figure 11 illustrates this simple yet powerful model that predicts the existing and future quality of streams based on the measurable change in impervious cover.

The model classifies streams into one of three categories: sensitive, impacted, and non-supporting. Each stream category can be expected to have unique characteristics as follows:

**Sensitive Streams.** These streams typically have a watershed impervious cover of zero to 10%. Consequently, sensitive streams are of high quality, and are typified by stable channels, excellent habitat structure, good to excellent water quality, and diverse communities of both fish and aquatic insects. Since impervious cover is so low, they do not experience frequent flooding and other hydrological changes that accompany urbanization. It should be noted that some sensitive streams located in rural areas may have been impacted by prior poor grazing and cropping practices that may have severely altered the riparian zone, and consequently, may not have all the properties of a sensitive stream. Once riparian management improves, however, these streams are often expected to recover.

**Impacted Streams.** Streams in this category possess a watershed impervious cover ranging from 11 to 25%, and show clear signs of degradation due to watershed urbanization. Greater storm flows begin to alter the stream geometry. Both erosion and channel widening are clearly evident. Stream banks become unstable, and physical habitat in the stream declines noticeably. Stream water quality shifts into the fair/good category during both storms and dry weather periods. Stream biodiversity declines to fair levels, with the most sensitive fish and aquatic insects disappearing from the stream.

**Non-Supporting Streams.** Once watershed impervious cover exceeds 25%, stream quality crosses a second threshold. Streams in this category essentially become a

conduit for conveying stormwater flows, and can no longer support a diverse stream community. The stream channel becomes highly unstable, and many stream reaches experience severe widening, down-cutting and streambank erosion. Pool and riffle structure needed to sustain fish is diminished or eliminated, and the stream substrate can no longer provide habitat for aquatic insects, or spawning areas for fish. Water quality is consistently rated as fair to poor, and water contact recreation is no longer possible due to the presence of high bacterial levels. Subwatersheds in the non-supporting category will generally display increases in nutrient loads to downstream receiving waters, even if effective urban stormwater practices are installed and maintained. The biological quality of non-supporting

streams is generally considered poor, and is dominated by pollution tolerant insects and fish.

Figure 12 compares the three classes of urban streams and the corresponding degradation of

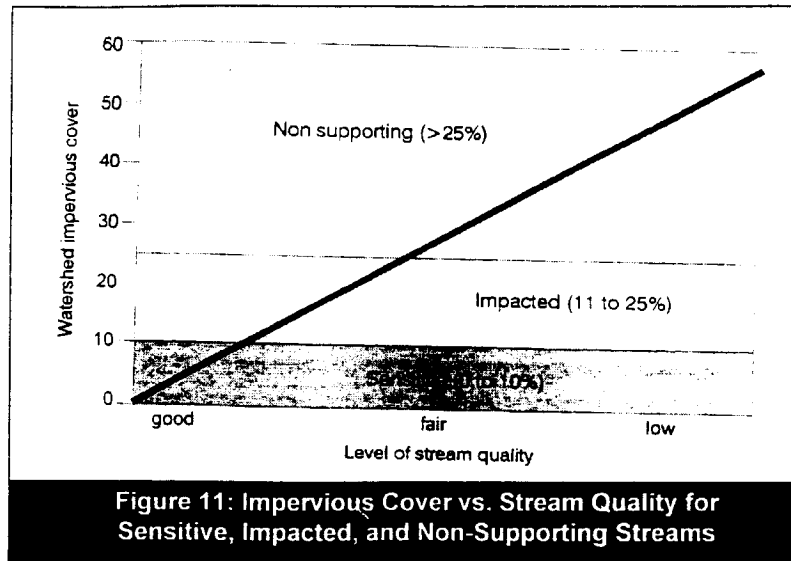

Figure 11: Impervious Cover vs. Stream Quality for Sensitive, Impacted, and Non-Supporting Streams

stream quality with increases in impervious cover. These three stream reaches are located in the Mid-Atlantic Piedmont, each has about the same drainage area. As the figure shows, impervious cover can create a dramatic difference in channel stability, water quality, and aquatic biodiversity within the same physiographic region.

**Limitations on Impervious Cover Model**

Although the impervious cover model is supported by research, its assumptions and limitations need to be clearly understood. There are some technical issues involved in its development that are discussed below.

**1. Scale effect.** The impervious cover model should generally only be applied to smaller urban streams from first to third order. This limitation reflects the fact that most of the research has been conducted at the catchment or subwatershed level (0.2 to 10 square mile area), and that the influence of impervious cover is strongest at these spatial scales. In larger watersheds and basins, other land uses, pollution sources and



disturbances often dominate the quality and dynamics of streams and rivers.

**2. Reference condition.** The simple model predicts **potential** rather than **actual** stream quality. Thus, the reference condition for a sensitive stream is a high quality, non-impacted stream within a given ecoregion or sub-ecoregion. It can and should be expected that some individual stream reaches or segments will depart from the predictions of the impervious cover model. For example, physical and biological monitoring may find

poor quality in a stream classified as sensitive, or good diversity in a non-supporting one. Rather than being a shortcoming, these "outliers" may help watershed managers better understand local watershed and stream dynamics. For example, an "outlier" stream may be a result of past human disturbance, such as grazing, channelization, acid mine drainage, agricultural drainage, poor forestry practices, or irrigation return flows.

**Sensitive Stream**

- (Impervious Cover  $\leq 10\%$ )
- Stable Channel
- Excellent Biodiversity
- Excellent Water Quality

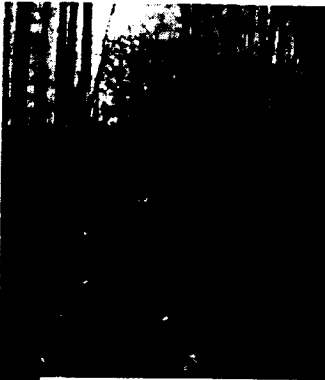

**Impacted Stream**

- (Impervious Cover 11-25%)
- Channel Becoming Unstable
- Fair to Good Biodiversity
- Fair to Good Water Quality



**Non-Supporting Streams**

- (Impervious Cover  $> 25\%$ )
- Poor to No Biodiversity
- Poor Water Quality



Figure 12: Impacts of Increasing Imperviousness on Stream Quality

**3. Statistical variability.** Individual impervious cover/stream quality indicator relationships tend to exhibit a considerable amount of scatter, although they do show a general trend downward as impervious cover increases. Thus, the impervious cover model is not intended to predict the precise score of an individual stream quality indicator for a given level of impervious cover. Instead, the model attempts to predict the average behavior of a group of stream indicators over a range of impervious cover. In addition, the impervious cover thresholds defined by the model are not sharp breakpoints, but instead reflect the expected transition of a composite of individual stream indicators.

**4. Measuring and projecting impervious cover.** Given the central importance of impervious cover to the model, it is very important that it be accurately measured and projected. Yet comparatively relatively little attention has been paid to standardizing techniques for measuring existing impervious cover, or forecasting future impervious cover. Some investigators define effective impervious area (i.e., impervious area directly connected to a stream or drainage system), which may be lower than total impervious cover under certain suburban or exurban development patterns (Sutherland, 1995).

**5. Regional adaptability.** To date, much research used to develop the model has been performed in the mid-Atlantic and Puget Sound eco-regions. In particular, very little research has been conducted in western, midwestern, or mountainous streams. Further research is needed to determine if the impervious cover model applies in these eco-regions and terrains.

**6. Defining thresholds for non-supporting streams.** Most research has focused on the transition from sensitive streams to impacted ones. Much less is known about the exact transition from impacted streams to non-supporting ones. The impervious cover model projects the transition occurs around 25% impervious cover for small urban streams, but more sampling is needed to firmly establish this threshold.

**7. Influence of stormwater practices in extending thresholds.** Urban stormwater practices may be able to shift the impervious cover thresholds higher. However, the ability of the current generation of urban stormwater practices to shift these thresholds appears to be very modest according to several lines of evidence. First, a handful of the impervious cover/stream indicator research studies were conducted in localities that had some kind of requirements for urban best management practices; yet no significant improvement in stream quality was detected. Second, Maxted and Shaver (1996) and Jones *et al.* (1996) could not detect an improvement in bioassessment scores in streams served by stormwater ponds.

**8. Influence of riparian cover in extending thresholds.** Conserving or restoring an intact and forested riparian zone along urban streams appears to extend the

impervious cover threshold to a modest degree. For example, Steedman (1988) found that forested riparian stream zones in Ontario had higher habitat and diversity scores for the same degree of urbanization than streams that lacked an intact riparian zone. Horner *et al.* (1996) also found evidence of a similar relationship. This is not surprising, given the integral role the riparian zone plays in the ecology and morphology of headwater streams. Indeed, the value of conserving and restoring riparian forests to protect stream ecosystems is increasingly being recognized as a critical management tool in rural and agricultural landscapes as well (CBP, 1995).

**9. Potential for stream restoration.** Streams classified by their potential for restoration (also known as restorable streams) offer opportunities for real improvement in water quality, stability, or biodiversity and hydrologic regimes through the use of stream restoration, urban retrofit and other restoration techniques.

**10. Pervious areas.** An implicit assumption of the impervious cover model is that pervious areas in the urban landscape do not matter much, and have little direct influence on stream quality. Yet urban pervious areas are highly disturbed, and possess few of the qualities associated with similar pervious cover types situated in non-urban areas. For example, it has recently been estimated that high input turf can comprise up to half the total pervious area in suburban areas (Schueler, 1995). These lawns receive high inputs of fertilizers, pesticides and irrigation, and their surface soils are highly compacted.

Although strong links between high input turf and stream quality have yet to be convincingly demonstrated, watershed planners should not neglect the management of pervious areas. Pervious areas also provide opportunities to capture and store runoff generated from impervious areas. Examples include directing rooftop runoff over yards, use of swales and filter strips, and grading impervious areas to pockets of pervious area. When pervious and impervious areas are integrated closely together, it is possible to sharply reduce the "effective" impervious area in the landscape (Sutherland, 1995).

While there are some limitations to the application of the urban stream impervious cover model, impervious cover still provides us with one of the best tools for evaluating the health of a subwatershed. Impervious cover serves not only as an indicator of urban stream quality but also as a valuable management tool in reducing the cumulative impacts of development within subwatersheds.

**Concept No. 5. A watershed manager needs to implement eight different watershed management tools in order to comprehensively protect any subwatershed.**

The eight tools roughly correspond to the stages of the development cycle from land use planning, site design, construction and ownership. A subwatershed plan is used to define how and where the tools are specifically applied to meet unique water resource objectives.

Perhaps the most important concepts in this handbook are the tools of watershed protection, which are thoroughly presented in article 27. Together, these eight tools can comprehensively protect and manage urban subwatersheds in the face of growth.

The first tool, **Land Use Planning**, is perhaps the most important because it involves decisions on the amount and location of development and impervious cover, and choices about appropriate land use management techniques. The second tool, **Land Conservation**, involves choices about the types of land that should be conserved to protect a subwatershed. **Aquatic Buffers** are the third tool, and involve choices on how to maintain the integrity of streams, shorelines, and wetlands, and provide protection from disturbance. The fourth tool is **Better Site Design**. This tool seeks to design individual development projects with less impervious cover which will reduce impacts to local streams. **Erosion and Sediment Control** deals with the clearing and grading stage in the development cycle when runoff can carry high quantities of sediment into

nearby waterways.

The sixth tool, **Stormwater Treatment Practices**, involves choices about how, when, and where to provide stormwater management within a subwatershed, and which combination of stormwater management practices can best meet subwatershed and watershed objectives. The seventh tool, **Non-Stormwater Discharges**, involves choices on how to control discharges from wastewater disposal systems, illicit connections to stormwater systems, and reducing pollution from household and industrial products. The final tool, **Watershed Stewardship Programs**, involves careful choices about how to promote private and public stewardship to sustain watershed management.

It is important to note that the watershed protection tools are flexible and can, and should, be applied differently in each subwatershed. Their application can also depend on the subwatershed category. For example, if development is being planned in an area that falls into the "sensitive stream" category, the tools involving land conservation and site design may be emphasized.

**Concept No. 6. While each subwatershed is unique, each can generally be classified into one of eight possible management categories, depending on its impervious cover and receiving water resource.**

These management categories are very useful in simplifying and expediting the preparation of subwatershed plans, since similar analysis techniques and man-

**Table 3: Eight Subwatershed Management Categories**

Subwatershed Category	Description
<b>Sensitive Stream</b>	<ul style="list-style-type: none"> <li>• Less than 10% impervious cover</li> <li>• High habitat/water quality rating</li> </ul>
<b>Impacted Stream</b>	<ul style="list-style-type: none"> <li>• 10% to 25% impervious cover</li> <li>• Some decline in habitat and water quality</li> </ul>
<b>Non-Supporting Stream</b>	<ul style="list-style-type: none"> <li>• Watershed has greater than 25% impervious cover</li> <li>• Not a candidate for stream restoration</li> </ul>
<b>Restorable Stream</b>	<ul style="list-style-type: none"> <li>• Classified as Impacted or Non-Supporting</li> <li>• High retrofit or stream restoration potential</li> </ul>
<b>Urban Lake</b>	<ul style="list-style-type: none"> <li>• Subwatershed drains to a lake that is subject to degradation</li> </ul>
<b>Water Supply Reservoir</b>	<ul style="list-style-type: none"> <li>• Reservoir managed to protect drinking water supply</li> </ul>
<b>Coastal/ Estuarine Waters</b>	<ul style="list-style-type: none"> <li>• Subwatershed drains to an estuary or near-shore ocean</li> </ul>
<b>Aquifer Protection</b>	<ul style="list-style-type: none"> <li>• Surface water has a strong interaction with groundwater</li> <li>• Groundwater is a primary source of potable water</li> </ul>

R0079608

agement tools are often applied to subwatersheds in the same management category.

Since each type of water resource has unique management characteristics, it is beneficial to create a strategy to differentiate between them. This manual introduces a series of eight distinct **subwatershed management categories** based on the type of water resource (i.e., stream, lake, estuary, or aquifer) and the intensity of the land uses within the subwatershed. Table 3 introduces each of the subwatershed categories and their management characteristics.

Distinguishing between the different aquatic systems helps watershed managers define the appropriate uses for a water resource and set realistic goals for managing those uses and protecting existing resources.

**Concept No. 7. Watershed managers have to make hard choices about what mapping, modeling, monitoring, and management techniques are needed to support watershed and subwatershed plans.**

A basic subwatershed plan, which utilizes the least cost techniques, represents about \$30,000 (although the actual cost can be reduced by volunteers or in-kind services). Much higher costs can be expected if watershed-wide analyses and subwatershed surveys are deemed necessary. An eight-step process is recommended to develop cost-effective watershed and subwatershed plans that lead to rapid implementation.

This process guides the watershed manager through the hard choices needed for a successful watershed plan. Each step in the process answers commonly asked questions, such as "What goals are attainable in my watershed?" The eight-step process is shown in Figure 13.

In the first step, the watershed manager establishes a watershed baseline. Important information is gathered, such as watershed and subwatershed boundaries, possible stakeholders, and existing impervious cover. Step 2 presents a watershed management structure that assists the manager with focusing various stakeholders while preparing, implementing, and revising the watershed plan in a timely manner. Step 3 helps the watershed manager determine available funding resources and how they can best be allocated. Step 4 discusses forecasting future land uses and associated impervious cover. This information will help you decide how the aquatic resources in your watershed will be affected.

Step 5 covers watershed and subwatershed goal setting. In this step, the information gathered in steps 1 through 4 is used to determine appropriate and achievable watershed protection goals. In the sixth step, the development of subwatershed plans is discussed. This step guides the manager in the basic analyses needed to effectively apply the watershed protection tools. Step 7

discusses how the watershed plan can be administered in a watershed. This step provides guidance in the legalities of plan implementation. Step 8 takes the watershed manager through the process of revising and updating the watershed management plan as changes in monitoring data or development occur over time.

**Concept No. 8. A watershed plan stands little chance of ever being implemented unless broad consensus is reached among the many stakeholders that might be affected by the plan.**

A stakeholder is defined as any agency, organization, or individual that is involved in or affected by the decisions made in the subwatershed plan. Stakeholders should be given frequent and meaningful input in plan development: sharing data and maps, establishing goals and objectives, selecting watershed indicators, and customizing watershed management tools. Ultimately, a group of stakeholders can evolve into a more permanent watershed management structure that can provide the long-term commitment and resources needed to implement the plan.

In a real sense, every current and future resident of a watershed is a stakeholder, even though they may be unaware of this fact. Watershed stewardship programs can increase awareness and broaden community support to implement watershed plans. The ideal group of stakeholders for designing a subwatershed plan will be determined by the level of interest of local parties in water quality and resource protection issues. Typical non-agency and agency stakeholders are listed in Figure 14.

**Concept No. 9. Watershed planning is a continuous management process that leads to real implementation.**

To manage workloads and budgets, it is often useful to develop groups of subwatershed plans within a defined management cycle. Individual subwatersheds can be initiated on an alternating sequence so that a few subwatersheds are finished every year, and all are finished within five to seven years. Each subwatershed plan is revisited in the next watershed management cycle, and plans are refined for more effective implementation. The watershed management cycle helps integrate individual subwatershed management with watershed-wide management.

Effective watershed management requires periodic reevaluation of plans as land uses change over time. A recommended approach is to develop each subwatershed plan within a defined management cycle that may last from five to seven years. The preparation of individual subwatershed plans can be arranged in an

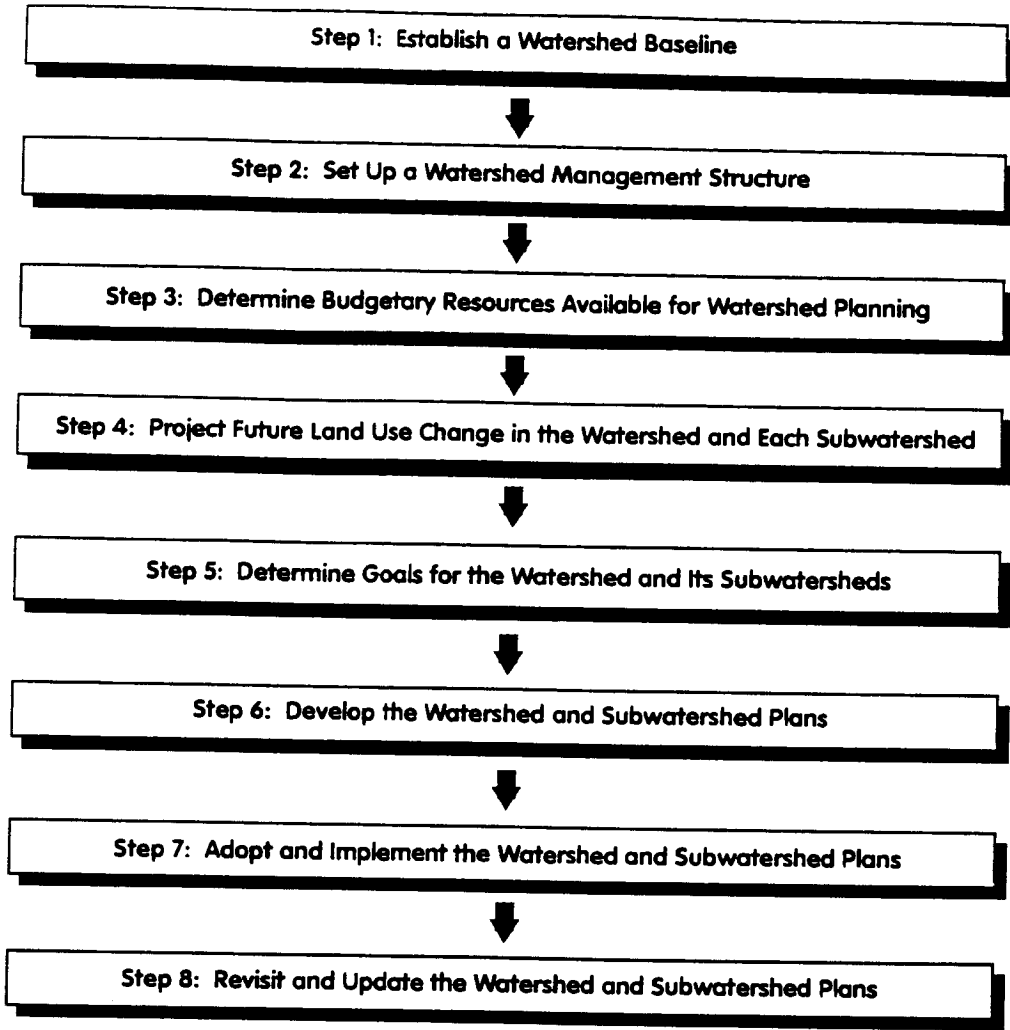

Figure 13: The Eight Rapid Steps of a Local Watershed Plan

**Typical Non-Agency Stakeholders:**

- Citizen Associations
- Water Resource Conservation Groups
- Developers
- Property Owners
- Outdoor Recreation Clubs
- Local Planner
- Individual Citizens
- Farmers
- Business Interests (industrial, commercial business owners)
- Utility Companies
- Environmental Advocates

**Typical Agency Stakeholders:**

- Regional Council of Government
- Planning Board
- Health Department

Figure 14: Typical Stakeholders in the Watershed Management Process

alternating series so that a few are started each year with all the plans being completed within a five to seven year time span. Larger jurisdictions with several watersheds may choose to identify watershed planning regions and have several planning cycles running concurrently.

Another benefit of the subwatershed management cycle is that workloads can be balanced against the schedule for conducting management and assessment. This allows managers to group subwatersheds into units so that each year a set of subwatersheds will begin a new phase in the process. This type of scheduling may also help conserve an organization's resources by simultaneously conducting stakeholder, monitoring, and implementation activities for whole sets of subwatersheds.

It may be practical to schedule some measurement or monitoring actions for all subwatersheds at the onset of the cycle. Early scheduling of activities, such as measuring impervious cover and conducting resource based monitoring, allows planners to designate subwatershed classification categories (i.e., sensitive, impacted, or non-supporting stream) and more easily prioritize subwatersheds according to their classification.

Communities may also consider phasing the management cycle. This entails identifying the different types of subwatershed management categories within the watershed as a first step. On an interim basis, specific subwatershed criteria can be applied to all the subwatersheds within the same management categories. This allows the most important and specific goals, like preventing stream degradation from one classification to the next, to be applied until the details of the watershed plan are complete.

#### References

- Arnold, C. P. Boison and P. Patton. 1982. "Sawmill Brook: an Example of Rapid Geomorphic Change Related to Urbanization." *Journal of Geology*, 90: 155-166.
- Booth, D., D. Montgomery, and J. Bethel. 1996. "Large Woody Debris in The Urban Streams of the Pacific Northwest." In *Effects of Watershed Development And Management on Aquatic Systems*. L. Roesner (ed.) Engineering Foundation Conference. Proceedings. Snowbird, UT. August 4-9, 1996. Pp. 178-197.
- Chesapeake Bay Program (CBP). 1995. *Water Quality Function of Riparian Forest Buffer Systems in the Chesapeake Bay Watershed*. US Environmental Protection Agency, Annapolis, MD 220 pp.
- Clements, et al. 1996. *Framework for a Watershed Management Program*. Water Environment Research Foundation, Alexandria, VA. 150 pp.
- Crawford, J and D. Lenat. 1989. *Effects of Land Use on Water Quality and the Biota of Three Streams in the Piedmont Province of North Carolina*. USGS. Water Resources Investigations Report 89-4007. Raleigh, NC, 67 pp.
- Duda, A. and K. Cromartie. 1982. "Coastal Pollution from Septic Tank Drainfields." *Journal of the Environmental Engineering Division (ASCE)* 108 (EE6).
- Evelt, et al. 1994. *Effects of Urbanization and Land Use Changes on Low Stream Flow*. North Carolina Water Resources Research Institute, Report No. 284. 66 pp.
- Ferguson, B and P. Suckling. "Changing Rainfall-Runoff Relationships in the Urbanizing Peachtree Creek Watershed, Atlanta, Georgia." *Water Resources Bulletin*, American Water Resources Association (AWRA) April 1990.
- Galli, J. 1991. *Thermal Impacts Associated with Urbanization and Stormwater Management Best Management Practices*. Metropolitan Washington Council of Governments. Maryland Department of Environment. Washington, D.C. 188 pp.
- Gregory, K. R. Davis and P. Downs. 1992. "Identification of River Channel Change Due to Urbanization." *Applied Geography*. 12:299-318
- Hicks, A.L. 1995. *Impervious Surface Area and Benthic Macroinvertebrate Response as an Index of Impact on Freshwater Wetlands*. M.S. Thesis, Department of Forestry and Wildlife Management, University of Massachusetts. Amherst, MA.
- Hollis, F. 1975. "The Effects of Urbanization on Floods of Different Recurrence Intervals." *Water Resources Research*, 11:431-435.
- Hoos, A.B. 1990. *Effects of Stormwater Runoff on Local Groundwater Quality*. Clarksville, Tennessee (Water Resources Investigations Report #90-4404). Tennessee Dept. of Health and Environment, Division of Construction Grants and Loans.
- Homer et al. 1996. "Watershed Determinates of Ecosystem Functioning." *Effects of Watershed Development and Management on Aquatic Ecosystems*. Roesner, L.A. (editor). Snowbird Utah. August 4-9, 1996. Engineering Foundation.
- Jones et al. 1996. "Bioassessment of the BMP Effectiveness in Mitigating Stormwater Impacts on Aquatic Biota." *Effects of Watershed Development and Management on Aquatic Ecosystems*.
- Leopold, Aldo. 1933. *Game Management*. Scribners and Sons. New York. 482 pp.

R0079611

- MacRae, C. 1996. "Experience from Morphological Research on Canadian Streams: Is Control of the Two-Year Frequency Runoff Event the Best Basis for Stream Channel Protection?" *Effects of Watershed Development and Management on Aquatic Systems*. L. Roesner (ed.) Engineering Foundation Conference. Proceedings. Snowbird, UT. August 4-9, 1996. pp. 144-160.
- Maxted, J., and E. Shaver. 1996. "The Use of Retention Basins to Mitigate Stormwater Impacts on Aquatic Life". *Effects of Watershed Development and Management on Aquatic*: L. Roesner (ed.) Published by the American Society of Civil Engineers. Proceedings of an Engineering Foundation Conference. August 4-9, 1996, Snowbird, UT.
- May, C. R. Horner, J. Karr, B. Mar, and E. Welch. 1997. "Effects of Urbanization on Small Streams in the Puget Sound Lowland Ecoregion." *Watershed Protection Techniques*, 2(4): 483-494.
- Monagle, W. 1996. "Utilizing a Phosphorus Allocation Model to Assess Cumulative Impacts from New Watershed Development." *Proceedings of a Symposium on Assessing Cumulative Impacts from Watershed Development on Aquatic Ecosystems and Water Quality*, March 19-21, 1996. North-eastern Illinois Planning Commission, Chicago, Illinois.
- Montgomery County (Maryland) Department of Environmental Protection (MCDEP). 1998. *Countywide Stream Protection Strategy*. Montgomery County Department of Environmental Protection and Maryland-National Capital Park and Planning Commission.
- Prince Georges Department of Environmental Resources (PGDER). 1997. *Low Impact Development Design Manual*. Department of Environmental Resources, Prince Georges County, Maryland.
- Schueler, T. 1995. "The Peculiarities of Perviousness." *Watershed Protection Techniques*. 2(1):233-239
- Schueler, T. 1994. "The Importance of Imperviousness." *Watershed Protection Techniques*. 1(3)-100-111.
- Schueler, T. 1987. *Controlling Urban Runoff: a Practical Manual for Planning and Designing Urban Best Management Practices*. Metropolitan Washington Council of Governments. Washington, D.C., 272 pp.
- Simmons, D and R. Reynolds. 1982. "Effects of Urbanization on Baseflow of Selected South-Shore Streams, Long Island, NY." *Water Resources Bulletin*. 18(5): 797-805.
- Strahler, A.N. 1957. "Quantitative Analysis of Watershed Geomorphology." *American Geophysical Union Transactions*, 38:913-920.
- Sutherland, R. 1995. "Methodology for Estimating the Effective Impervious Area of Urban Watersheds." *Watershed Protection Techniques*, 2(1): pp 282-284.
- Taylor, B.L. 1993. *The Influences of Wetland and Watershed Morphological Characteristics and Relationships to Wetland Vegetation Communities*. Master's Thesis. Dept. of Civil Engineering. University of Washington, Seattle, WA.
- Trimble, S. 1997. "Contribution of Stream Channel Erosion to Sediment Yield from an Urbanizing Watershed." *Science*. 278: 1442-1444.
- United States Environmental Protection Agency. 1995. *Clean Lakes Program 1993/1994 Annual Report*. EPA 841-s-95-003. U.S. EPA, Office of Water, Washington, DC. 240 pp.
- Wolman, M. G., 1954. *A Method of Sampling Coarse Bed Material*. Transactions of the American Geophysical Union, v. 35, p. 951-956.
- Wright Water Engineers (WWE). 1995. *Fulbright Spring Protection Study*. Denver, CO.

# Crafting Better Watershed Protection Plans

**A** dynamic local watershed management plan is arguably the best and most comprehensive tool to protect urban streams, lakes, and estuaries from the cumulative impact of land development. In practice, however, few such plans have actually realized this goal. Rather, most watershed plans are little more than a one-time report that is quickly consigned to the bookshelf to languish in obscurity, never to be read or implemented. This article examines why local watershed plans often fail to live up to their promise, and is organized into two parts. The first part outlines 11 frequently cited reasons for poor outcomes in local watershed plans, drawn from a critical analysis of several dozen past watershed monitoring, modeling, and management efforts, as well as the experience of a number of watershed planning practitioners.

The second part of the article proposes a 12-point protocol to prepare more effective watershed management plans that avoid these common problems. The core of the protocol is a simple method to classify and manage urbanizing watersheds, based on measurements of current or projected impervious cover. The method emphasizes the importance of impervious cover management at both the site and watershed scale through limits on the amount of new impervious cover that can be created. The protocol explicitly links the cumulative impact of future growth to zoning and application of urban best management practices at the subwatershed level. Other elements of the local watershed plan protocol emphasize subwatershed scales, regular management cycles, resource-based monitoring, integrated resource mapping, local program audits and subwatershed-specific development criteria. Together, these elements should improve the effectiveness of local watershed protection plans as a management tool to prevent cumulative impacts.

## A Critique of Local Watershed Plans: 11 Reasons Why Watershed Plans End Up on the Shelf

Everyone seems to agree that the watershed is the most appropriate geographic unit to protect urban water resources. Indeed, the 1990s will undoubtedly be remembered as the decade in which the watershed approach became a dominant paradigm for local environmental management. Despite this welcome trend, it is reasonable to ask whether local watershed plans have actually worked to protect streams from degradation

from the cumulative impact of land development.

At the outset, it is important to distinguish between the watershed *study* and the watershed *management plan*. The former is a *technical analysis* to identify water quality problems in a watershed and define their sources, and may also explore possible options to remedy them. The watershed management plan, on the other hand, is a much more comprehensive *management process* that should ultimately lead to the implementation of measures that collectively protect the watershed from the impacts of future development (i.e., land use, site planning, riparian management, and stormwater practices) and establish a baseline to gauge the effectiveness of that implementation.

Over the last year, staff at the Center have interviewed a wide cross-section of environmental planners, municipal officials, consultants, watershed scientists and others about the effectiveness of local watershed management plans. The consensus was that most had failed to adequately protect their watersheds. Failure, as defined here, is the inability of a plan to meaningfully prevent or reduce cumulative impacts at the watershed scale in the long run. In this sense, an effective watershed protection plan is one that produces the desired long-term outcome of protecting streams (or other water resources) from degradation.

When asked about the wide gulf between watershed planning and implementation, our admittedly unscientific sample cited one or more of the following reasons for poor watershed plan outcomes:

### *Reason No. 1: Plan was conducted at too great a scale.*

Scale was considered the *critical factor* in preparing effective local watershed plans. Quite simply, when watershed plans were conducted on too large a scale (50 or more square miles), the focus of the plan became too fuzzy. Too many different subwatersheds had to be considered, and important differences in stream quality and development patterns could not be isolated. Land use changes were too complex to forecast. The critical link between individual land use decisions or restoration projects and the watershed plan was broken. While the number of stakeholders involved in the plan proliferated, actual responsibility for implementing the plan diminished. Costs for both monitoring and watershed analysis skyrocketed. A bewildering number of non-urban water quality sources, issues and problems complicated the



picture. In short, the watershed planning process was too big to be effective. Only by "decomposing" it into smaller, more manageable watershed units, was it possible to produce a meaningful plan.

*Reason No. 2: Plan was a one-time study rather than a long-term and continuous management commitment.*

A common complaint concerned the fact that the local government did not fully commit its resources and authority to a long-term watershed management process. Instead, the plan was conceived as a short-term study that would produce the requisite answers in a year or two. As a result, the watershed management effort was quickly transformed from a process into a report, and within a few years, the report and its recommendations were forgotten amid competing priorities.

*Reason No. 3: Lack of local ownership in the watershed management process.*

A related problem was the tendency for many communities to hand off responsibility to a consultant or their own technical staff. Many local planners and officials perceive watershed management as a daunting and complex technical challenge, and are all too happy to shift the responsibility to someone who knows better. Consequently, the task was assigned to a single project manager, who in turn assigned it to a technical consultant. While this approach helps complete the technical study in a timely fashion, it generally doesn't generate the kind of internal consensus and support needed to champion the watershed management process. An overreliance on technical consultants often means that few local staff have much ownership or understanding of the plan, and, consequently, have little stake in the outcome of the watershed management process.

*Reason No. 4: Plan skirted real issues about land use change in the watershed.*

For many, a key flaw in their watershed plan was a failure to accurately measure land use, or project how it would change in response to the prevailing zoning or comprehensive plan. Detailed analysis of current or future land use or impervious cover was either not scoped in the plan, not budgeted, or simply unavailable. In a surprising number of cases, consideration of alternative land use densities or locations was not part of the study. Few watershed plans actually attempted to directly measure or forecast cumulative impacts based on impervious cover, and therefore could not directly test whether the watershed plan would actually mitigate or prevent cumulative impacts.

*Reason No. 5: Budget for watershed plan was poor or unrealistic.*

Numerous watershed plans were hamstrung by the fact that the original scope of work was far too broad and

ambitious to be completed with available resources. By the time extensive watershed mapping and baseline monitoring tasks were completed, the project budget was all but exhausted. Few resources remained to begin the watershed management process, much less to develop the funding and consensus to adopt and implement it. In many cases, monitoring merely confirmed what was already known, or produced reams of data of little value to managers. By contrast, many watershed budgets scrimped on the considerable staff resources needed to develop and implement the plan. The recurring budget shortfalls suggest that watershed monitoring may be overemphasized (and budgeted) at the expense of the watershed management process. The potentially high cost of monitoring and mapping elements are seldom fully appreciated by watershed managers.

*Reason No. 6: Plan focused on the tools of watershed analysis rather than their outcomes.*

Many consultants and planners were overly-fascinated with the many tools of watershed analysis, such as geographic information systems (GIS), computer simulation modeling, intensive stormwater monitoring and the like. As a result, many of these studies were more about demonstrating the intrinsic value or legitimacy of one of these tools, than about the specific watershed management outcome. Quite simply, a fancy GIS map, a finely calibrated model, or an extensive monitoring baseline will never serve as a watershed plan. This is not meant to imply that any of these tools are not helpful for local watershed management, just that they are only tools, and rather expensive ones at that. Once again, a watershed plan should be focused on tangible outcomes with respect to land use and practices. The tools of watershed analysis are a means toward that end, but should never be confused with the end product.

*Reason No. 7: Document was too long or complex.*

Many local watershed plan documents were uncharitably described as Watershed Environmental Impact Statements. Running into several hundred pages, or even several volumes, many watershed plans were too long and complex to induce anyone to read them. The thickness may have been needed to justify the many dollars that were invested in their production, but ended up obscuring the real findings and issues, and intimidating the lay reader. Frequently, decision-makers could not even find, much less understand, the specific watershed management recommendations they were supposed to implement.

*Reason No. 8: Plan failed to critically assess adequacy of existing local programs.*

Few plans seriously considered the complex management process of how to get the proposed management measures implemented across the watershed over

the next several decades. In particular, little attention was paid to critically evaluating the management capability of existing local government to handle future watershed development decisions, whether it be funding, organization, staffing, enabling ordinances, regulations or the development review process. The central question of whether the objectives of the watershed plan could be successfully integrated into each of the hundreds of individual development decisions that were expected to occur in the future in the watershed was not adequately addressed.

*Reason No. 9: Plan recommendations were too general.*

A particular criticism by many respondents was the fact that most watershed plans were too general. One individual noted that the plan recommendations could have been written in a couple of hours by a group of reasonable people *before* the study ever began. A quick survey of recent plans supports this contention. The familiar litany of general watershed recommendations is surprisingly similar. For example, one plan recommended improved erosion and sediment control for new development, but never considered how to pay for more inspectors. The need for greater agency coordination was highlighted in another, but no actual mechanism was proposed to achieve it. A third plan recommended wider use of stormwater practices, but remained conspicuously silent on how they were to be selected, designed or maintained. A long-term watershed monitoring program was proposed in another, but no agency was assigned to implement it. The need for a stream buffer network was also identified, but the required ordinance or performance criteria was omitted. Restoration projects were identified in yet another study, but were not ranked in priority order, much less included in the local capital budget.

The key point of this litany is that we already know in advance generally what we need to do protect watersheds from development, but we lack either the management tools or the community consensus to get it done. Therefore, plan recommendations need to be as specific as possible, including the *authority, budget and timetable to make it happen*. The term "watershed management" implies that responsibilities are assigned, resources are allocated, and timetables are adhered to for each specific recommendation. Yet, it is the rare plan that considers these essential management tasks.

*Reason No. 10: Plan had no regulatory meaning.*

Perhaps the greatest reason cited for consigning watershed plans to the shelf was that no one was required to pull it down and use it as a routine part of the land development process. Consultants, planners, and local officials are exceptionally busy and generally do not read watershed plans as a leisure activity. Therefore, unless land development is required to conform to

the specific criteria and maps outlined in the watershed plan, few people have a compelling reason to even open it.

*Reason No. 11: Key stakeholders are not involved in developing the management plan.*

A good urban watershed management plan creates meaningful change in how and where land is developed. Changes of this nature will always be controversial. The purpose of the watershed management process is to allow stakeholders a legitimate and early opportunity to participate in the development of the plan. Stakeholder involvement provides the foundation to obtain the feedback, consensus, and support needed in the implementation. Yet it is often the case that most local watershed plans only ask for feedback at the end of the study, if at all. Important stakeholders, such as developers, environmentalists, property owners, non-governmental organizations, and local, state, and federal agencies, are often not included. Each of these parties will be affected in some way by the subwatershed plan, and if they are not satisfied with their opportunity to participate in it, they will likely turn their considerable energies to defeating it. If stakeholders are not provided a meaningful role in the watershed management process, needless controversy will inevitably result.

### **Twelve Elements of an Effective Local Subwatershed Management Plan**

It is evident from the foregoing discussion that many first-generation watershed studies have failed to deliver on their promise of protecting urban watersheds from degradation. When the reasons for the poor outcomes are analyzed, however, the limited effectiveness of plans is not so surprising. There seems to be no underlying framework or protocol that supports the local watershed management process. Is it possible to develop such a protocol? In order to promote dialogue on the subject, the Center has drafted an initial outline of the possible elements of a local watershed protocol (see Table 1). It is drawn from a variety of sources—practical experience of watershed practitioners from around the country, a number of recently completed subwatershed studies (Grand Traverse County, 1995; MNCCPC, 1995; Johnson Creek Corridor Committee, 1995), and watershed planning documents and protocols (Clements *et al.*, 1996; Arnold and Gibbons, 1996; USEPA, 1991 and 1995). The 12 elements of the protocol are enumerated below.

#### *No. 1: Create a Watershed Management Institution*

A key milestone in any subwatershed plan is the creation of a formal or informal authority that is invested with primary responsibility for implementing and then updating the plan after it is developed. Communities may elect to create a single authority at the watershed level, or a series of smaller authorities at the

subwatershed level. At any rate, the plan should set forth the structure of any interagency or multi-jurisdictional partnerships needed, and where possible, explore funding mechanisms to support for the required management activities needed over the entire subwatershed cycle. As Clements *et al.* (1996) notes, a single agency champion must take responsibility for leading the watershed institution-building process. In many cases, the stakeholder involvement process (see No. 11) helps to determine the membership and structure of the institution. The watershed institution is the only reliable way to provide the continuous, long term management commitment needed to implement the plan.

*No. 2: Subwatershed Scale*

The subwatershed is probably the best unit to develop an effective management plan. Subwatersheds are defined as having drainage areas of two to 15 square mile in size. In most cases, the influence of impervious cover on hydrology, water quality and biodiversity is most strongly felt at the subwatershed scale. Due to their size, many subwatersheds are entirely contained within the same political jurisdiction which helps to establish a clear and direct regulatory authority. Depending on their size, a typical municipality or county might have 10 to 50 subwatersheds to manage.

Another practical advantage for choosing subwatersheds as the primary management unit is that they can be mapped at a resolution that is meaningful to a planner or the public. (e.g., the entire subwatershed can easily fit on a standard 24 by 36 inch quad sheet at 1 inch:2000' scale, or equivalent to a U.S. Geological Survey quadrangle or National Wetlands Inventory map). This choice makes it easier to relate individual development or restoration projects to the overall subwatershed plan and to initially locate many (but not all) of the larger environmental features on the map (larger wetlands, the stream buffer network, steep slopes, etc.)

A last practical advantage of the subwatershed scale is that it is small enough to perform required monitoring, mapping and other tasks of the watershed study in a relatively brief time frame (perhaps six to 12 months). It is generally possible to complete the watershed management plan within a year's time, while still providing sufficient time for criteria development, agency coordination and stakeholder involvement. The fact that each subwatershed management plan can be done in such a short time-frame enables local governments to develop multiple subwatershed management plans in a regular and coordinated cycle.

*No. 3: Subwatershed Management Cycle*

Clements *et al.* (1996) has advanced the concept of the subwatershed management cycle for local planning. In brief, each subwatershed plan in a locality is prepared under a defined management cycle that lasts five to seven years. Preparation of individual subwatershed

**Table 1: Twelve Elements of an Effective Subwatershed Management Plan**

No.	Subwatershed Management Planning Element
1.	Create watershed management institution
2.	Conduct at the subwatershed scale
3.	Commit to a continuous watershed management cycle
4.	Accurately measure and forecast land use
5.	Shift the location and density of future development
6.	Produce integrated resource map for subwatershed
7.	Devise specific criteria to guide subwatershed development
8.	Emphasize strategic resource-based monitoring
9.	Audit effectiveness of local watershed protection programs
10.	Incorporate priorities from larger watershed management units
11.	Actively engage stakeholders and include public early and often
12.	Promote intra- and inter-agency coordination



plans are sequenced according to a staggered schedule, with a few started each year in a rotation so that all local subwatershed plans are completed within five to seven years (See Figure 1).







The actual management plan for an individual subwatershed is expected to take no longer than 12 months to complete. To provide continuous management, however, each subwatershed plan is revisited and updated at the beginning of each new cycle. In particular, strategic monitoring data and changes in impervious cover are collected in each to assess the effectiveness of the subwatershed plan. Another benefit of the subwatershed management cycle is that it helps local authorities to balance their workload, and provides a defined schedule for management and assessment activities.

From a practical standpoint, some communities may want to schedule some management or monitoring tasks at the onset of the subwatershed management cycle. Examples include strategic indicator monitoring to identify sensitive streams and measurement of impervious cover in all subwatersheds to identify growth areas. If these tasks are completed early, managers can more easily target which subwatersheds should be addressed on a priority basis. In addition, communities may want to phase the rotation of their subwatershed cycle so that the first four include representative examples of sensitive, impacted, non-supporting, and restoration streams. Specific subwatershed criteria developed in these first four subwatersheds can then be applied on an interim basis to subwatersheds of the same classification until such time as all subwatershed plans are completed.

Figure 1: Subwatershed Management Cycle

	First Management Cycle					Second Management Cycle						
	Year 1	Year 2	Year 3	Year 4	Year 5	Year 6	Year 7	Year 8	Year 9	Year 10		
Subwatershed 1	C	S	M	I		C	S	M	I			
Subwatershed 2	C	S	M	I		C	S	M	I			
Subwatershed 3	C	S	M	I		C	S	M	I			
Subwatershed 4	C	S	M	I		C	S	M	I			
Subwatershed 5	C		S	M	I	C		S	M	I		
Subwatershed 6	C		S	M	I	C		S	M	I		
Subwatershed 7	C		S	M	I	C		S	M	I		
Subwatershed 8	C		S	M	I	C		S	M	I		
Subwatershed 9	C			S	M	I	C			S	M	I
Subwatershed 10	C			S	M	I	C			S	M	I
Subwatershed 11	C			S	M	I	C			S	M	I
Subwatershed 12	C			S	M	I	C			S	M	I

Subwatershed Management Phases

-  Strategic Monitoring
-  Adopt Interim Stream Management Plan
-  Measure Impervious Cover
-  Implementation
-  Begin Subwatershed Study
-  Revise Subwatershed Management Plan
-  Adopt Stream Management Plan

No. 4: Measuring Land Use Change

Impervious cover is perhaps the best indicator of development activity, and is of great use for both classifying urban streams and managing subwatersheds (Arnold and Gibbons, 1996; Schueler, 1995). Each subwatershed can be classified into one of three functional categories, based on current or future estimates of percent impervious cover:

	<u>Impervious cover</u>
Sensitive streams	0 to 10%
Impacted streams	11 to 25%
Non-supporting streams	26 to 100%

This simple classification scheme emphasizes the key role of impervious cover in influencing the future quality of urban streams, based on a range of hydrological, habitat, water quality and ecological studies conducted over broad geographic regions (Schueler 1995). A series of research studies demonstrated that a relatively low percentage of impervious cover (10 to 15%) can induce adverse and irreversible changes in the quality of streams. Similarly, many streams become non-supporting once watershed impervious cover exceeds 25% (Table 2). The scheme provides a simple but powerful method to predict the future quality of streams, based on measurable land use change.

Therefore, the accurate measurement of impervious cover will be an important element in any subwatershed plan. The study plan should clearly describe the techniques that will be used to estimate both current and future land use, and the method to convert land use data into estimates of impervious cover. In many cases, *current* land use and impervious cover can be directly estimated from low altitude aerial photography, at reasonable cost. Estimating *future* impervious cover, however, is much more problematic. To begin with, the two techniques used to estimate future land use change—*zoning buildout* and the *rate of growth adjustment*—are often imprecise and can give conflicting estimates. For example, zoning buildout analysis assumes that all development shown on a zoning map will ultimately be constructed, and then multiplies each zoned acre by average impervious cover for that particular zone. Zoning, however, reflects a locality's long-term dreams about economic growth. Consequently, much of the development shown on the maps will never be built because of economic conditions or the lack of roads, sewers and water to serve it. Thus, zoning buildout analysis can overestimate impervious cover, at least for the first several decades.

The second technique, known as *rate of growth adjustment*, also has problems. Typically, future impervious cover is derived by simply multiplying current impervious cover by a projected rate of population or economic growth. The rate of growth adjustment is based on local forecasting models, most of which extend only 15 or 20 years in the future. Growth rates may be wildly inaccurate if demographic or economic assumptions in the model prove to be either optimistic or pessimistic. It is therefore good practice to choose a mid-range estimate that falls between the short-run rate of growth adjustment technique and the more long-run zoning buildout technique.

Both techniques rely on general land use/impervious cover ratios that indicate the percent impervious cover associated with a particular zoning category. An original source for these estimates was a study in the Washington metropolitan area performed by NVPDC (1978). Subsequent reanalysis has indicated that these ratios do not always include collector and arterial streets, or highways that can sharply increase impervious cover. Therefore, communities may wish to derive their own local land use/impervious cover ratios during the low altitude aerial photography phase to estimate current impervious cover. Random sampling and analysis of "blocks" from existing zoning categories should be satisfactory.

*No. 5: Change Current Zoning in Subwatersheds*

A subwatershed plan is essentially a test whether existing zoning can maintain or support aquatic resources in the future. The relationships between impervious cover and stream quality noted earlier provide a

**Table 2: Stream Characteristics Based on Impervious Cover**

Stream Variable	Sensitive	Impacted	Non-Supporting
Channel stability	Stable	Unstable	Highly unstable
Water quality	Good to excellent	Fair to good	Fair to poor
Biodiversity	Good to excellent	Fair to good	Poor

quantitative framework to make this assessment. The entire process, known as subwatershed-based zoning, is outlined in Table 3. In short, a jurisdiction analyzes its inventory of subwatersheds, and classifies streams based on current and future impervious cover. If future growth is expected to downgrade a stream's classification, the current zoning of the subwatershed may need to be decreased to maintain stream quality. Additional growth may be shifted to other subwatersheds, which have additional room under the impervious "cap," given their stream classification.

Subwatershed-based zoning has many important benefits. First, it is an excellent framework to track cumulative development impacts over time in a series of subwatersheds. The reliance on impervious cover also acknowledges the primacy of land use control as the first defense to protect watersheds. Subwatershed-based zoning explicitly recognizes that the potential quality of a stream is determined, to a great extent, by impervious cover, and therefore, stream protection tools need to be adapted to different subwatersheds. Subwatershed zoning is ideally suited to growth management, as it provides a framework to direct growth to subwatersheds that have the needed infrastructure to support it. New development is shifted to where it has occurred in the past, concentrating growth and avoiding sprawl.

**Table 3: Process for Watershed Based Zoning**

1. Comprehensive stream inventory
2. Verify impervious cover/stream quality relationships
3. Measure current levels of impervious cover
4. Project future levels of impervious cover
5. Designate subwatersheds, based on stream quality categories
6. Modify master plan/zoning to meet subwatershed impervious cover targets
7. Incorporate management priorities from larger watersheds/basins
8. Adopt specific stream protection strategies for each subwatershed
9. Long-term monitoring cycle to assess stream status



**Table 4: Subwatershed Development Criteria**

**Example 1: Sensitive Streams (0 to 10% impervious cover)\***

Goal: Maintain predevelopment biodiversity  
 Land Use: Watershed and site impervious cover limits  
 Practices: Maintain predevelopment hydrology and recharge  
 Emphasis on ED and infiltration  
 Restrictions on wet ponds  
 "Country drainage"  
 Buffers: Widest stream buffers, protect sensitive areas  
 Monitoring: Biological, including single species (e.g., trout)  
 Other tools: Land acquisition, clearing limits, extra ESC control

**Example 2: Impacted Streams (11 to 25% impervious cover)**

Goal: Limit degradation of stream habitat and quality  
 Land Use: Upper limit on subwatershed impervious  
 Practices: All emphasize pollutant removal/channel protection  
 Buffers: Standard three zone, variable width stream buffers  
 Monitoring: Biological and physical indicators  
 Other tools: Regional pond systems, low input lawn care, site planning techniques

**Example 3: Non-Supporting Streams (26% or greater impervious cover)**

Goal: Minimize downstream pollutant loads/prevent floods  
 Land Use: No watershed cap, redevelopment encouraged  
 Practices: Maximize removal of phosphorus/metals/toxins  
 No restrictions on ponds and wetlands  
 Buffers: Greenway for recreation/flood protection  
 Monitoring: Water quality trends and loads  
 Other tools: Pollution prevention, illicit connections, "hotspot" management

**Example 4: Restorable Stream\*\* (non-supporting or impacted stream)**

Goal: Restore stream biodiversity to impacted or sensitive levels  
 Land Use: Limited watershed redevelopment with full stormwater practices, some infill  
 Practices: Subwatershed restoration w/stormwater retrofit ponds and wetland creation  
 Buffers: Acquisition or easements on stream corridors, riparian reforestation  
 Monitoring: Biological monitoring, citizen monitoring  
 Other tools: Pollution prevention, "hotspot" management, watershed awareness, fish barrier removal, floodplain wetland creation

\* Impervious cover limits are approximate.

\*\* Potential candidate for restoration based on completion of subwatershed restoration inventory.

*No. 6: Integrated Resource Map*

Another key product of a subwatershed study is an integrated resource map. The map shows the public and the development community the location of catchments, steep slopes, floodplains, stream buffers, wetlands, forest conservation areas, parks, open space, existing

development, future zoning, stormwater practices or watershed restoration projects, and strategic monitoring stations—all on a single sheet. As noted earlier, the small size of most subwatersheds allows them to be portrayed on a standard sheet at a reasonable mapping scale (e.g., 1" to 2000' or 1" to 1000' or even finer). While this scale is not fine enough to reveal the entire stream network, all development parcels or every environmental feature, it helps planners, citizens, and developers all visualize the spatial implementation of the subwatershed plan.

*No. 7: Subwatershed Development Criteria*

An important outcome of any subwatershed management plan is the adoption of specific development criteria that are consistent with its stream classification. These criteria are not intended to be another layer of rules and regulations, but to make better sense of existing ones. The performance criteria outline what is typically expected at each development site. Thus, they may include site or subwatershed impervious cover limits; performance criteria to select, design and locate stormwater practices; criteria for the width and management of the stream buffer; and appropriate stream protection tools. Several examples of subwatershed development criteria are outlined in Table 4 for each of three stream categories (plus a restoration category). Once adopted in the plan, all new development in the subwatershed must conform to the expanded criteria. Consultants must then routinely refer to the subwatershed plan during land development to determine applicable site requirements. This helps ensure an eternal readership for the plan. Both the integrated resource map and subwatershed development criteria provide a greater degree of certainty to the development process, which is often desirable in land transactions.

*No. 8: Strategic Resource-Based Monitoring*

The objective of monitoring is to provide timely feedback on how the aquatic resource is responding to the management practices outlined in the plan. Given the high cost of monitoring, communities need to be very strategic about what, when and where they intend to sample. For this reason, many have chosen to focus on environmental indicators of change, such as physical parameters, biological diversity and habitat quality. Once the baseline is established, these lower cost stream indicators are then sampled on a five to seven year rotation (according to the local subwatershed management cycle). To ensure that the sampling is consistent and can be repeated in the next cycle, the subwatershed management plan should document the rationale for selecting stream indicators, establish the location of all long-term stream monitoring stations or reaches, and document the sampling technique and frequency used to measure each indicator. Such information ensures that future monitoring in the cycle will be fully compatible with the baseline data.

An often neglected component of subwatershed monitoring is the measurement of various indicators of management performance. Examples include the growth of impervious cover, surveys of public attitudes or behavior, number of stormwater practices installed or maintained, rates of permit compliance stream miles in buffer, waivers granted, or restoration projects constructed (Claytor and Brown, 1996). These programmatic indicators can measure progress made toward plan implementation, and provide an excellent basis to assess the plan after the first management cycle.

#### *No. 9: Audit of Local Programs*

A subwatershed management plan should include a critical assessment of existing local capability to implement the plan during each stage of the development cycle. This "audit" should examine whether existing local tools exist or are adequate to implement the plan. The scope of the audit might include an analysis of local master plans, ordinances, development review process, performance criteria, program funding and staffing levels. The audit should identify key deficiencies that need to be remedied. Where possible, the audit should utilize actual and quantitative measures of local program efforts (such as waivers, inspections, maintenance, rezoning applications, plan review workloads, permit backlogs).

#### *No. 10: Consistency with Larger Watershed Management Units*

Each subwatershed is nested within many larger watersheds, sub-basins and basins. As an example, Sligo Creek *subwatershed* lies within the Anacostia *watershed*, which in turn, lies within the Potomac River *sub-basin*, which is but a part of the Chesapeake Bay *basin*. It is obvious that subwatershed management plans must be developed within the context of the larger watershed management units in which they are located. The first and most simple step is to identify each of the larger watershed management units. Next, key water quality management objectives from these units should be incorporated into the subwatershed plan. Some of regional objectives that often transcend the subwatershed are fish passage, nutrient or toxic reduction targets, water supply, flood protection and wastewater effluent limits. Early coordination with state and federal agencies can ensure these objectives are fully integrated into the subwatershed plan.

It is interesting to note that an increasing number of state governments are adopting a "basin management approach" (BMA) to systematically manage water resources at the scale of the watershed, sub-basin and basins (USEPA, 1995; Clements *et al.*, 1996). The BMA approach has many similar characteristics to the subwatershed management cycle, and offers an opportunity for greater consistency among watershed management units.

#### *No. 11: Early Stakeholder and Public Involvement*

To obtain consensus and support needed for future implementation, it is very important to have a representative group of subwatershed "stakeholders" to guide the development of the plan. A stakeholder is defined as any agency, organization, or individual that is involved in or affected by the decisions made in the subwatershed plan. The ideal group of stakeholders might include interested citizens, developers, environmentalists, consultants, planners and property owners. In addition, many local agencies may have a strong interest (e.g., parks, public works, transportation and planning agencies) and state, regional or even federal water resource agencies may also wish to be represented.

By virtue of their small scale and great number, most subwatersheds will have a manageable number of stakeholders to guide plan development. Early and frequent stakeholder involvement is essential to develop consensus in what could otherwise be a controversial process. The roles of stakeholders should be well-defined, meaningful, and wide-ranging—sharing data and mapping, setting priorities, establishing goals, developing subwatershed development criteria, measuring success, reviewing and even approving the plan. In some communities, the stakeholder group may ultimately evolve into a permanent watershed management committee or task force.

In a real sense, every current and future resident is a stakeholder, although most are unaware of their everyday role in protecting the subwatershed. A key goal of the subwatershed plan, then, is to increase watershed awareness among the public and more actively engage them in protection efforts. A targeted outreach and education program is often the best means to achieve this goal. In this respect, community attitude surveys are often indispensable in scoping critical watershed issues.

#### *No. 12: Intra- and Inter-Governmental Coordination*

It is almost a ritual to invite a broad spectrum of local, state and federal agencies to participate in watershed plans, which necessarily involves a lot of coordination meetings. Such coordination is absolutely essential when the watershed in question extends over more than one political jurisdiction. The problem is how to get such a diverse group to do more than just attend meetings. To get an interagency group to share resources and data, develop and endorse the plan, and become true partners in the long-term management process requires strong skills in the art of bureaucratic navigation. One instrument that can help steer the process are political agreements to legitimize the watershed management partnership. In most cases, the first agreement is simply to participate in the process, with few binding obligations or financial commitments. Subsequent agreements may become more formal and de-



tailed over time, reflecting the growing trust and consensus among the participants.

Some subwatershed plans may require less extensive interagency partnerships, since they are entirely contained within a single local jurisdiction. For these subwatersheds, bureaucratic navigation can be confined to local agency coordination, i.e., reaching consensus among the many conflicting units of local government (planning, development review, public works, parks, resource management, transportation, and economic development to name but a few). Each of these units of local government plays a key role in either the formulation or implementation of the subwatershed plan, and needs to be represented in the stakeholder process. Several local governments have organized local interagency workgroups to address overarching issues, using independent facilitators to guide the group toward consensus.

#### Subwatershed Planning and the Real World

While it is easy to outline what should be done in subwatershed planning, it is obviously much harder to actually make it happen. After all, what community isn't subject to tight budgets, strong development interests, and a planning horizon that extends to the next local election? When local political will is lacking, is the subwatershed management planning protocol described here just a pipe dream? (or for that matter, any watershed approach).

The answer is a somewhat guarded no. The proposed subwatershed protocol represents a new way of thinking about local watersheds that emphasizes practical management tasks. As such, it is not expected to cost more than traditional watershed studies (and possibly less, given that the monitoring effort is often less intensive). In addition, the protocol is oriented to actively engage both stakeholders and the general public to build consensus for the long-term management process. Thus, even if the results of the first management cycle are less than desired, it is possible to improve the plan during the next cycle. If local political currents run strongly against land use controls, the protocol clearly shows the likely long-term changes in stream quality (and provides guidance on how the changes can best be managed).

If watershed planning is ever to become an effective tool to protect streams in the real world, it will be because they incorporate the practical management details that lead to better implementation. The 12 management elements outlined here represent an initial exploration into this new territory.

#### References

- Arnold, C. and C. Gibbons. 1996. "Impervious Surface Coverage: The Emergence of a Key Environmental Indicator." *Journal of the American Planning Association*. 62(2): 243-258.
- Clements, T. C. Creager, A. Beach, J. Butcher, M. Marcus and T. Schueler. 1996. *A Framework for Watershed Management. Final Report*. Project 93-IRM-4 Water Environment Research Foundation. WERF. Alexandria, VA 212 pp.
- Clayton, R. and W. Brown. 1996. *Environmental Indicators to Assess the Effectiveness of Municipal and Industrial Stormwater Control Programs*. Final Report. Center for Watershed Protection. US EPA Office of Wastewater Management. Silver Spring, MD. 210 pp.
- Grand Traverse County (MI). 1995. *Mitchell Creek Watershed Protection Strategy*. Mitchell Creek Watershed Planning Team. Traverse City, MI. 268 pp.
- Johnson Creek Corridor Committee. 1995. *Johnson Creek Resources Management Plan*. Woodward Clyde Consultants. Portland, OR. 210 pp.
- Maryland National Capital Park and Planning Commission (MNCPPC). 1995. *Upper Paint Branch Watershed Planning Study—Technical Report*. Montgomery County Planning Department. Silver Spring, MD. 68 pp.
- Northern Virginia Planning District Commission (NVPDC). 1978. *Land Use/Runoff Quality Relationships in the Washington DC Metropolitan Area*. Final Report. Occoquan/Four Mile Run NPS Correlation Study. MWCOG. 73 pp.
- Schueler, T. 1995. *Site Planning for Urban Stream Protection*. Center for Watershed Protection. Metropolitan Washington Council of Governments. Silver Spring, MD 222 pp.
- US EPA. 1991. *The Watershed Protection Approach: An Overview*. Report No. EPA 503/9-92-002. Office of Water.
- US EPA. 1995. *Watershed Protection: A Statewide Approach*. US EPA Office of Water. Assessment and Watershed Protection Division. Washington, D.C.

R0079621



# Article 30

Feature article from *Watershed Protection Techniques*, 2(4): 469-481

## The Economics of Watershed Protection

**W**atershed protection may be a fine idea, but how much does it cost? How does it change the bottom line for the region, the development community, landowners and residents alike? This question is increasingly being posed to

those advocating better watershed protection. In this article, we review economic research on the costs and benefits of employing watershed management tools and tally the score for the region, the municipality, the developer and the property owner.

3

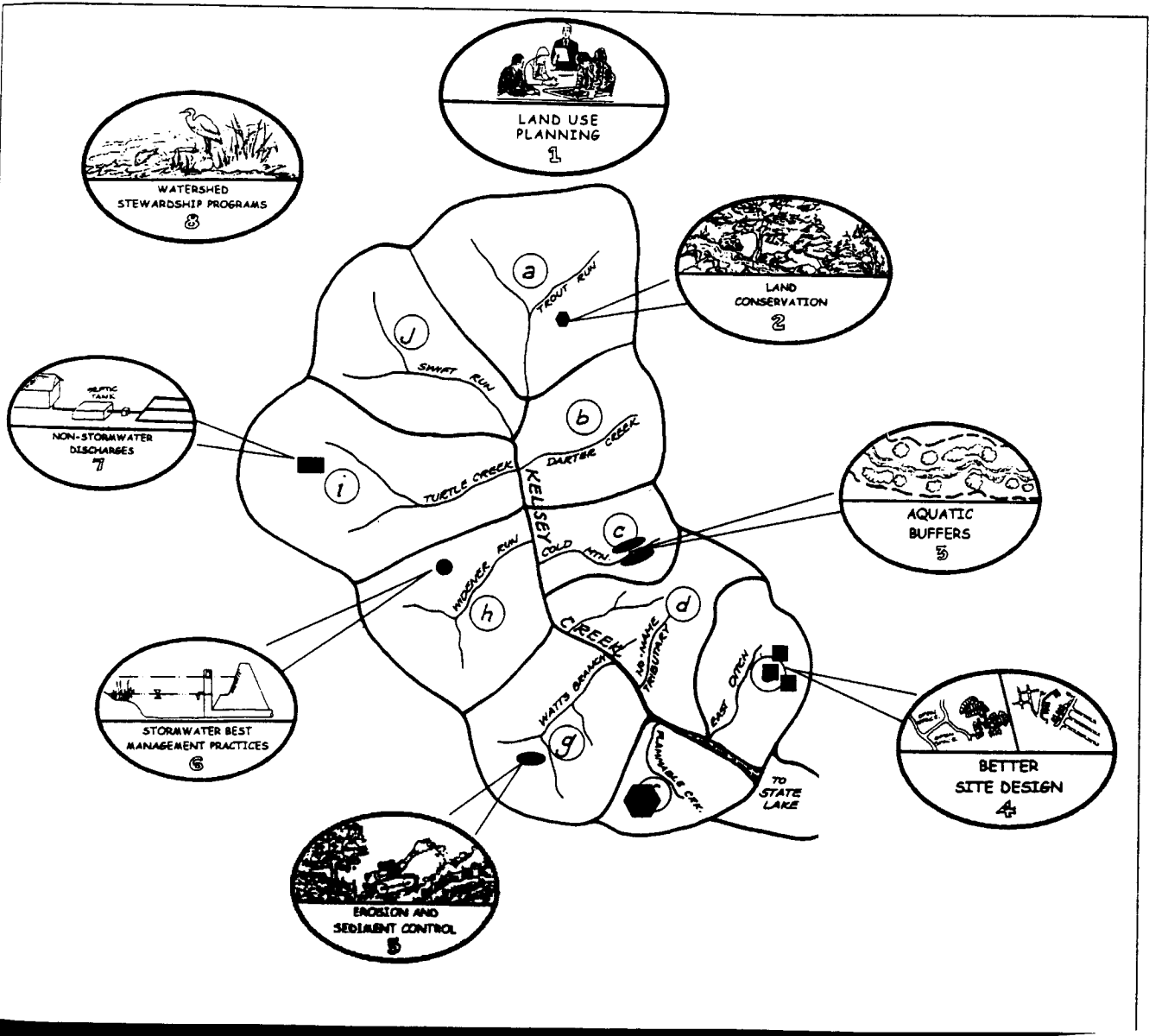

Figure 1: Eight Tools for Watershed Protection

R0079622

### Economic Benefits of Watershed Protection Tools

Watershed development does not have to be synonymous with the degradation of aquatic resources. When new growth is managed in a watershed context, homes and businesses can be located and designed to have the smallest possible impact on streams, lakes, wetlands and estuaries. In the watershed protection approach outlined here, communities can apply eight basic tools that guide where and how new development occurs (see Figure 1).

The watershed protection tools highlighted in this article are designed to protect water quality while increasing the value of existing and developable land. If used correctly, these tools can protect the rights of individual property owners as well as those of the entire community.

Many players in the local economy perceive that watershed protection can be costly, burdensome and potentially a threat to economic vitality. Others counter that watershed protection is inextricably linked to a healthy economy. Below we review some of the actual research on the economic costs and benefits associated with each of the eight watershed protection tools. While economic research on many of the tools is rather sparse, much of the evidence indicates that these tools can have a positive or at least neutral economic effect, when applied properly.



The first and most important tool is local land use planning, a process for identifying key watershed uses, and then directing the appropriate level of new growth to those subwatersheds that can best afford and accommodate it (Schueler, 1995). Land use planning involves assessing stream conditions and developing strategies to maintain or restore their condition. It directs proposed development to the least sensitive area and attempts to control the amount and location of impervious cover in a watershed. Some subwatersheds are designated as growth areas, while others are partly or fully protected from future development. Many communities wonder about the effect of such broad-based land use planning on property values and the local tax base. Recent studies, however, suggest that the effect of watershed planning is largely positive:

- Beaton (1988) examined land values before and after the Maryland Critical Area and New Jersey Pinelands land use regulations were imposed. He found that the regulations had no impact on the

volume of construction activity, and had slightly improved the local tax base. This was because the value of developed land within the regulated area had climbed from five to 17%, and the value of vacant land had increased by five to 25%. As Beaton notes, "Residents in both regions benefited from the knowledge that public actions were taken to protect the environmental amenity in which they had already invested." Since both developed and undeveloped land had grown in value, owners received a significant premium when they sold their property.

- Land use plans that retain open space, rural landscapes, and recreational opportunities contribute to the quality of a community or region. A survey of chief executive officers has ranked quality of life as the third most important factor in locating a new business (National Park Service, 1992). As regional economies become ever more competitive, a high quality-of-life ranking can provide a critical edge in attracting new business.
- Citizens also rank protection of their water resources quite highly. A North Carolina survey showed a strong preference for spending more public funds on environmental protection than for highway construction, welfare, or economic development. Only crime and education ranked as higher spending priorities among citizens (Hoban and Clifford, 1992).
- However, watershed planning is not without costs. Effective watershed planning requires a careful local investment in technical studies, monitoring, coordination and outreach. As Brown (1996) notes, a community can expend several hundred thousand dollars on a watershed study to obtain the scientific data to justify land use decisions. Further, the long-term cost to fully implement a watershed plan can be significant for many local governments.

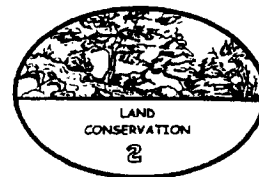

Communities have repeatedly found that property adjacent to protected wetlands, floodplains, shorelines, and forests constitutes an excellent location for development. (U.S. EPA, 1995). A sense of place is instilled by the presence of water, forest and natural areas and this preference is expressed in a greater willingness to pay to live near these habitats. Examples include the following:

- Two regional economic surveys documented that conserving forests on residential and commercial sites can enhance property values by an average of six to 15% and increases the rate at which units are sold or leased (Morales, 1980; Weyerhaeuser Company, 1989). An Atlanta study also showed that the presence of trees and natural areas measurably increased the residential property tax base (Anderson and Cordell, 1982). In addition, urban forests boost property values by reducing irritating noise levels and screening adjacent land uses. The absence of trees increases dust levels by four to 100 times (Nelson, 1975).
- Conserving trees also saves money on energy bills and treatment of runoff. Studies by the American Forest Association have shown that homes and businesses that retain trees save 20 to 25% in their energy bills for heating and cooling, compared to homes where trees are cleared. The urban forest canopy also helps to reduce the volume of stormwater runoff. A modeling study by Hanson and Rowntree (1988) reported that stormwater decreased by 17% due to forest cover in a Utah development during a typical one-inch rainstorm.
- Coastal wetland areas contribute to the local economy through recreation, fishing and flood protection. Various economists have calculated that each acre of coastal wetland contributes from \$800 to \$9,000 to the local economy (Kirby, 1993).

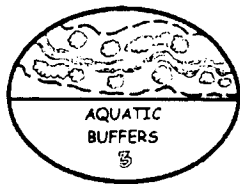

A shoreline or creek buffer can create many market and non-market benefits for a community, particularly if they are managed as a greenway:

- The value of adjacent property increases. For example, housing prices were found to be 32% higher if they were located next to a greenbelt buffer in Colorado (Correll *et al.*, 1978). Nationally, buffers were thought to have a positive or neutral impact on adjacent property values in 32 out of 39 communities surveyed (Schueler, 1995).
- Forested shoreline and stream buffers situated on the flat soils of the coastal plain have been found to be effective in removing sediment, nutrients and bacteria from stormwater runoff and septic system effluent in a wide variety of rural and agricultural settings along the East Coast (Desbonnet *et al.*, 1994).

- Buffers provide a critical "right of way" for streams during large floods and storms. When buffers contain the entire 100-year floodplain, they are an extremely cost-effective form of flood damage avoidance for both communities and individual property owners. As an example, a national study of 10 programs that diverted development away from flood-prone areas found that land next to protected floodplains had increased in value by an average of \$10,427 per acre (Burby, 1988).
- Homes situated near seven California stream restoration projects had a three to 13% higher property value than similar homes located on unrestored streams (Streiner and Loomis, 1996). Most of the perceived value of the restored stream was due to the enhanced buffer, habitat, and recreation afforded by the restoration.
- In addition, buffers can sharply reduce the number of drainage complaints received by local public works departments and they are often an effective means to mitigate or even prevent shoreline erosion.
- A shoreline or creek buffer can help protect valuable wildlife habitat. For example, each mile of buffer protects 12 acres of habitat along shorelines and 25 acres along creeks (Schueler, 1995). A continuous buffer provides a wildlife corridor which is of particular value in protecting amphibian and waterfowl populations, as well as coastal fish spawning and nursery areas. Such protection has an economic payoff as well. For example, Adams (1994) reports that nearly 60% of suburban residents actively engage in wildlife watching near their homes, and a majority are willing to pay a premium for homes located in a setting that attracts wildlife.
- Corporate land owners can save between \$270 to \$640 per acre in annual mowing and maintenance costs when open lands are managed as a natural buffer area rather than turf (Wildlife Habitat Enhancement Council, 1992).
- When managed as a "greenway," stream buffers can expand recreational opportunities and increase the value of adjacent parcels (Flink and Searns, 1993). Several studies have shown that greenway parks increase the value of homes adjacent to them. Pennypack Park in Philadelphia is credited with a 33% increase to the value of nearby property. A net increase of more than \$3.3 million in real estate value is attributed to the park (Chesapeake Bay Foundation, 1996a). A greenway in Boulder, Colorado, was found to have increased aggregate property values by \$5.4 million, resulting in \$500,000 of additional tax revenue per year (Chesapeake Bay Foundation, 1996a).

R0079624

- Effective shoreline buffers can increase the value of urban lake property. For example, a recent study of Maine lakes found that water clarity was directly related to property values. Specifically, a three-foot improvement in water clarity resulted in \$11 to \$200 more per foot of shoreline property, potentially generating millions of dollars in increased value per lake (Michael *et al.*, 1996).

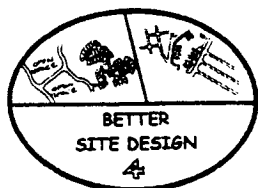

Better site design involves approaching new development with the goals of reducing impervious cover and increasing the conservation of natural areas. One way to accomplish this is through cluster development, which minimizes lot sizes within a compact developed portion of a property while leaving the remaining portion prominently open. Housing can still consist of detached single family homes as well as multi-family housing or a mix of both. Cluster development creates protected open space that provides many market and non-market benefits. For example, some communities have found that cluster development:

- Can reduce the capital cost of subdivision development by 10 to 33%, primarily by reducing the length of the infrastructure needed to serve the development (NAHB, 1986; Maryland Office of Planning, 1989; Schueler, 1995).
- Typically keeps from 40 to 80% of total site area in permanent community open space. Much of the open space is managed as natural area, which often increases the future value of residential property in comparison to low-density subdivisions. This premium has ranged from five to 32% in communities in the Northeastern United States. In Massachusetts, cluster developments were found to appreciate 12% faster than conventional subdivisions over a 20-year period (Lacey and Arendt, 1990). In Howard County, Maryland, a cluster development with an average lot size of one acre had the same market value as a conventional subdivision with one to five acre lots (Legg Mason, 1990).
- Can reduce the need to clear and grade 35 to 60% of total site area. Since the total cost to clear, grade and install erosion control practices can range up to \$5,000 per acre, reduced clearing can be a significant cost savings to builders (Schueler, 1995).

- Can reserve up to 15% of the site for active or passive recreation. When carefully designed, the recreation space can promote better pedestrian movement, a stronger sense of community space and a park-like setting. Numerous studies have confirmed that developments situated near trails or parks sell for a higher price than more distant homes.
- Provides a developer some "compensation" for lots that would otherwise have been lost due to wetland, floodplain or other requirements. This, in turn, reduces the pressure to encroach on stream buffers and natural areas.
- Can reduce site impervious cover from 10 to 50% (depending on the original lot size and layout), thereby lowering the cost for both stormwater conveyance and treatment. This cost savings can be considerable, as the cost to treat the quality and quantity of stormwater from a single impervious acre can range from \$2,000 to \$50,000 (see article 68). In addition, the ample open spaces within a cluster development provide a greater range of locations for more cost-effective stormwater runoff practices.

Some indication of the potential savings associated with "open space" or cluster development are shown in the Remlik Hall Farm example produced by Land Ethics, Inc. for the Chesapeake Bay Foundation (1996b). Cost estimates were derived for two development scenarios that result in equivalent yield to the developer (see Table 1). In the conventional scenario, the farm is subdivided into 84 large-lot units, whereas in the open-space scenario 52 higher-end units are located on smaller lots in three clusters. Over 85% of the site is retained in open space, as farmland, forest or wetland as illustrated in Figure 2.

The authors computed net development savings of over \$600,000 for this 490-acre cluster development (or about 50% lower costs than the conventional scenario). These large savings in development infrastructure including engineering, sewage and water, and road construction costs certainly contribute to a better bottom line. In addition, Arendt (1994) maintains that open space units sell both more rapidly and at a premium, thus increasing cash flow which is always a prime concern to the developer.

Reducing the amount of impervious cover created by subdivisions and parking lots at developments can lead to savings for municipalities and developers. Impervious cover can be minimized by modifying local subdivision codes to allow narrower or shorter roads, smaller parking lots, shorter driveways and smaller turnarounds. These tools make both economic and environmental sense. Infrastructure—roads, sidewalks, storm sewers, utilities, street trees—normally constitute over half the total cost of subdivision development

**Table 1: Remlik Hall Farm Example: Costs, Land Cover, and Pollution Associated With Two Plans (CBF, 1996b)**

<b>Development Costs</b>		<b>Scenario A Conventional Plan</b>		<b>Scenario B Cluster Plan</b>	
1. Engineering Costs, (boundary survey, topo, road design, plans, monumentation)		\$79,600		\$39,800	
2. Road Construction Costs	20,250 linear ft.	\$1,012,500	9,750 linear ft.	\$487,500	
3. Sewage and Water (permit fees and design only)	Individual septic and wells	\$25,200		\$13,200	
4. Contingencies		\$111,730		\$54,050	
<b>GRAND TOTAL</b>		<b>\$1,229,030</b>		<b>\$594,550</b>	

<b>Land Cover and Storm-water Pollutant Estimate</b>		
<b>Total Site Area = 490.15 acres</b>		
<b>Total Developed Land</b>	287.41 acres (58.6%)	69.41 acres (14.2%)
Roads & Driveway	19.72 acres	11.75 acres
Turf	261.09 acres	54.04 acres
Buildings	6.60 acres	3.92 acres
<b>Total Undeveloped Land</b>	202.74 acres (41.4%)	420.64 acres (85.8%)
Forest	117.55 acres	133.01 acres
Wetlands	11.46 acres	11.46 acres
<b>Total Impervious Cover</b>	5.4%	3.7%
<b>Total Nitrogen (lbs per year)</b>	2,534 lbs/yr	1,482 lbs./yr
<b>Phosphorous (lbs per year)</b>	329 lbs/yr	192 lbs./yr

(CH2M-Hill, 1993). Much of the infrastructure creates impervious surfaces. Thus, builders can realize significant cost savings by minimizing impervious cover (Table 2). Some of the typical savings include the following:

- \$1,100 for each parking space that is eliminated in a commercial parking lot, with a lifetime savings in the range of \$5,000-\$7,000 per space when future parking lot maintenance is considered
- \$150 for each linear foot of road that is shortened (pavement, curb and gutter, and storm sewer)
- \$25 to \$50 for each linear foot of roadway that is narrowed
- \$10 for each linear foot of sidewalk that is eliminated

In addition to these direct costs savings, developers will realize indirect savings. For example, costs for stormwater treatment and conveyance are a direct func-

tion of the amount of impervious cover (see article 68). Thus, for each unit of impervious cover that is reduced, a developer can expect a proportionately smaller cost for stormwater treatment.



Current state and local requirements for erosion and sediment control (ESC) often do increase the cost of development. On a typical site, the cost to install and maintain erosion and sediment control can average \$800 to \$1,500 per cleared acre per year, depending on the



**R0079626**

Conventional Development Plan (A)

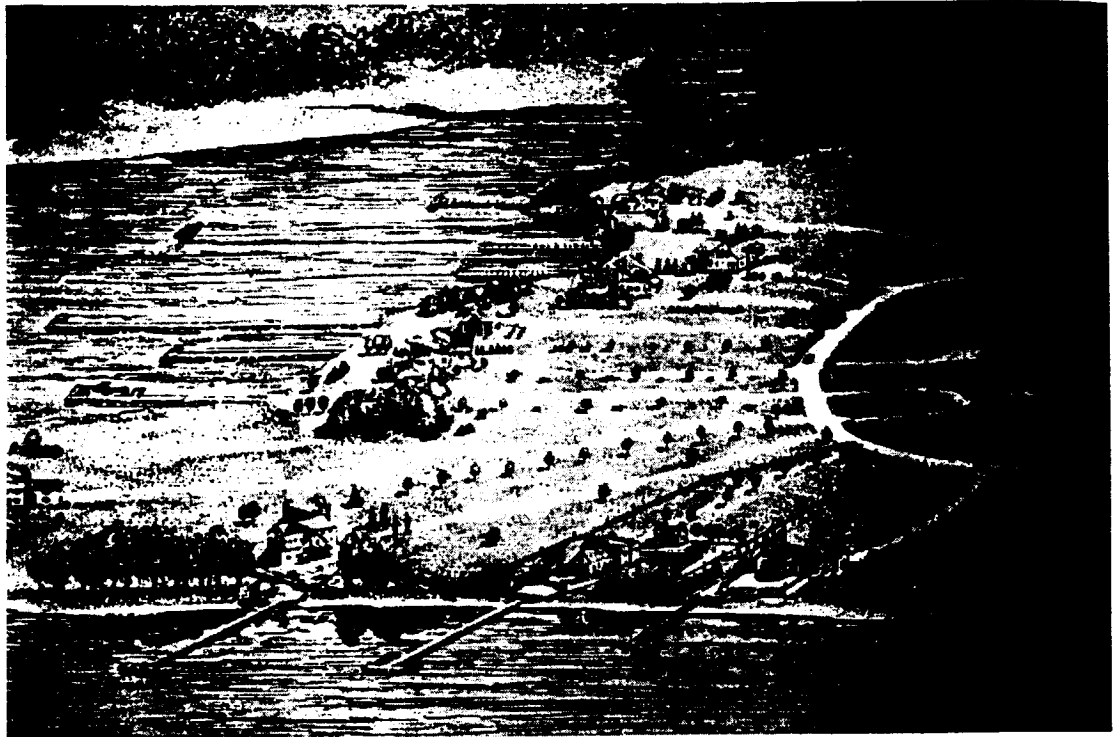

Cluster Development Plan (B)



Figure 2: Illustrations of the Remlik Hall Farm Case Study  
(Sources: Land Ethics, Inc. and Dodson & Associates)

duration of construction and the site conditions (SMBIA, 1990; Paterson *et al.*, 1993).

The application of other watershed protection tools, however, can help reduce the total cost for ESC control at a construction site. Forest conservation, buffers and clustering all can sharply reduce the amount of clearing needed at a site, thereby reducing the area that must be controlled by ESC practices.

ESC controls also provide direct and indirect benefits to both the builder and the adjacent property owner. By keeping soil on the site, a contractor needs to spend less time and labor re-grading the site to meet final plan elevations, and less effort stabilizing eroded slopes. Careful phasing of construction within subdivisions also often leads to economies over the entire construction process (see article 54).



Stormwater management practices, which include stormwater ponds, wetlands, filtering, infiltration, and swale systems, are among the most expensive watershed protection tools. Stormwater practices are designed to promote recharge, remove pollutants, prevent streambank erosion, and control downstream flooding. Despite their high construction and maintenance costs, stormwater practices can confer several tangible economic benefits, as the following studies show:

- The cost of designing and constructing stormwater practices can be very substantial. The most recent cost study indicates the cost of treating the quality and quantity of stormwater runoff ranges from \$2,000 to \$50,000 per impervious acre (see article 68). The construction costs do not include cost of land used for stormwater. Stormwater practice costs are greatest for small development sites (less than five acres), but drop rapidly at larger sites. In general, about a third of every dollar spent on stormwater practice construction is used for quality control, with the rest devoted for flood control.
- Stormwater management can also be beneficial for developers, since stormwater ponds and wetlands create a waterfront effect. For example, U.S. EPA (1995) recently analyzed 20 real estate studies across the U.S. and found that developers could charge a per lot premium of up to \$10,000 for homes situated next to well-designed stormwater ponds and wetlands. In addition, U.S. EPA found that office parks and apartments next to well-

**Table 2: The Unit Cost of Subdivision Development**  
(Source: SMBIA 1987 and others, as published in Schueler 1995)

<u>Subdivision Improvement</u>	<u>Unit Costs</u>
Roads, Grading	\$22.00 per linear foot
Roads, Paving (26 feet width)	\$71.50 per linear foot
Roads, Curb and Gutter	\$12.50 per linear foot
Sidewalks (4 feet wide)	\$10.00 per linear foot
Storm Sewer (24 inch)	\$23.50 per linear foot
Clearing (forest)	\$4,000 per acre
Driveway Aprons	\$500 per apron
Sediment Control	\$800 per acre
Stormwater Management	\$300 per acre (variable)
Water/Sewer	\$5,000 per lot (variable)
Well/Septic	\$5,000 per lot (variable)
Street Lights	\$2.00 per linear foot
Street Trees	\$2.50 per linear foot

designed stormwater practices could be leased or rented at a considerable premium (and often at a much faster rate).

- In a comparison of home prices in Minnesota, sale prices were nearly one-third higher for homes that had a view of a stormwater wetland compared to homes without any "waterfront" influence. Indeed, the homes near the stormwater wetland sold for prices that were nearly identical to those homes bordering a high quality urban lake (Clean Water Partnership, 1996).
- Not all stormwater practices provide a premium. For example, Dinovo (1995) surveyed the preferences of Illinois residents about living or locating next to dry ponds, and found most residents would not pay a premium to live next to a dry pond, and in some cases expected to pay less for such a lot. The study confirmed that wet ponds command a considerable premium and they even scored higher than natural areas, golf courses, and parks in some location decisions (see article 84).
- In addition, some stormwater practices, such as grassed swales and bioretention areas, actually are less expensive to construct than enclosed storm drain systems, and provide better environmental results. Liptan and Brown (1996) documented residential and commercial case studies where the use of bioretention and swales reduced the size and cost of conventional storm drains needed to meet local drainage and stormwater management requirements. The more natural drainage system eliminated the need for costly manholes, pipes, trenches and catchbasins, while removing pollutants at the same time. Total re-

R0079628

ported savings for the three projects ranged from \$10,000 to \$200,000.

- Stormwater practices must be maintained, and that cost burden falls on landowners or local government. Over a 20 to 25 year period, the full cost to maintain a stormwater practice is roughly equal to its initial construction costs (Wiegand *et al.*, 1986). Few property owners and homeowner associations are fully aware of the magnitude of stormwater maintenance costs, and most fail to regularly perform routine and non-routine maintenance tasks. It is likely that performance and longevity of many stormwater practices will decline without adequate maintenance. Therefore, local governments need to evaluate how the future maintenance bill will be paid and who will pay it.

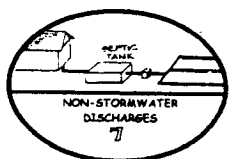

In many rural watersheds, new development occurs outside of water and sewer service areas, which means that wastewater must be treated on the site, usually by a septic system. To treat wastewater, septic systems must have appropriate drainage area and soil to function properly. Costs associated with installing septic systems—and correcting system failures—are as follows:

- The average cost of constructing a conventional septic system at a single family home situated on a large lot is around \$4,500 (U.S. EPA, 1993)—approximately equal to the unit cost of municipal wastewater (Table 2). The cost of more innovative septic systems (that have a higher nutrient removal rate, lower failure rates, or that can perform on poor soils) are 25 to 75% greater than conventional systems, with somewhat higher maintenance costs as well (see article 123).
- The cost to maintain a properly functioning septic system on an individual lot is not inconsequential. For example, the cost to inspect a septic system ranges from \$50 to \$150 per visit, and each pumpout costs about \$150 to \$250. The recommended pumpout frequency ranges from two to five years for a standard household tank. Over a decade, the total costs of maintaining a septic system can run from \$1,000 to \$3,000 (Ohrel, 1995).
- There are also major costs to landowners when septic systems fail. A failed or failing septic system can decrease property values, delay the issuance of building permits, or hold up the purchase

settlement (NSFC, 1995). In the event a septic system fails, homeowners can expect to pay from \$3,000 to \$10,000 for replacement.



After development occurs, communities still need to invest in watershed management programs. This tool is used to educate residents and businesses about the daily role they play in protecting the quality of their watershed. Thus, many communities now invest in programs of watershed education, public participation, watershed management, monitoring, inspection of stormwater treatment systems, low input lawn care, household hazardous waste collection, or industrial and commercial pollution prevention programs. The common theme running through each program is education.

The responsibility for ongoing watershed management programs is borne by local government, although many are now employing stormwater utilities to partially finance these programs (for a review of trends in stormwater utilities, see article 69). Nationally, the average residential stormwater utility fee is about \$30 per year, of which less than 75 cents is spent on watershed education.

#### The Balance Sheet: Watershed Protection Tools

The various costs and benefits associated with the eight watershed protection tools are summarized in the "balance sheet" shown in Table 3. Different costs and benefits accrue depending on whether one is a developer, property owner, community or local government. Taken as a package, most of the players tend to make out pretty well, but there are some key differences. For example, most watershed protection tools benefit landowners, in terms of appreciation of property values as long as they are in a developable area. This benefit is offset to some degree by real costs for maintenance of stormwater treatment systems as well as fees that may be charged for stormwater utilities.

Some watershed protection tools have the potential to save developers money, through lot premiums, greater marketability, and lower construction costs. At the same time, a developer has to pay out-of-pocket for stormwater and sediment control, as well as consultant fees to navigate through the watershed protection maze. As might be expected, the community at large gets the greatest overall benefit associated with watershed protection, and appears to bear the least cost (although

R0079629



they may have to pay more for housing).

The only consistent financial "loser" in the watershed protection balance sheet is local government. Local government must provide at least some staff and technical resources to guide, review, inspect, monitor, enforce and manage each watershed protection tool.

Even hiring one additional staff person can be a daunting challenge in this era of austere government, particularly if the person is even dimly linked to the possibility of more review, regulation or red-tape. Many players in the local economy are justifiably concerned about the economic consequences created by water-

shed protection. Thus, despite its long-term benefits, watershed protection is both fiscally and politically challenging for local governments. How, then, do communities craft watershed protection programs that can achieve the broad and deep acceptance needed to overcome these challenges? Successful communities have found it important to do the following:

- Invest early in watershed education and outreach
- Designate a single agency to champion watershed protection and play a role in the development process



**Table 3: Balance Sheet for Watershed Protection**

(-) negative economic consequence (+) positive economic or environmental impact

Watershed Protection Tools	Developer/Builder	Adjacent Property Owner	Community	Local Government
1. Land Use Planning	(-) cost of land (-) locational constraints	(+) property value	(+) business attraction (+) protection from adverse uses	(-) staff and budget resources (+) reduced "clean up"
2. Land Conservation	(+) natural area premium (-) permitting costs (-) locational constraints	(+) property value	(+) habitat (+) fisheries	(-) staff resources (+) reduced "clean up" costs (+) lower cost of services
3. Aquatic Buffers	(+) buffer premium (-) locational constraints	(+) property value	(+) flooding risk (+) wildlife (+) greenway (+) trails	(-) staff resources (+) fewer drainage complaints
4. Better Site Design	(+) construction costs (+) marketability (+) no lost lots	(+) property value (-) HOA fees (-) parking	(+) recreation (+) green space (+) natural area preservation (+) better sense of place (+) pedestrian friendly	(+) lower cost of services
5. Erosion and Sediment Control	(-) higher cost (+) savings in cleaning/grading	(+) trees saved increase value (+) no off-site sediment	(+) water quality (+) tree conservation	(-) staff resources (+) reduced complaints from downstreamers
6. Stormwater Treatment Practices	(-) higher costs (+) pond/wetland premium	(-) maintenance (+) waterfront effect (if done right)	(+) protection of water supply (+) stream protection	(-) staff resources (+) reduced waterbody programs/problems
7. Non-Stormwater Discharges	(-) higher design and engineering costs	(-) clean out costs	(+) protection of water supply	(-) staff resources
9. Watershed Stewardship Programs	no impact	(-) annual fee for utility (+) continued healthy environment	(-) annual fee (+) involvement in watershed services	(-) staff resources
<b>ECONOMIC TREND</b>	<b>MIXED</b>	<b>POSITIVE</b>	<b>POSITIVE</b>	<b>NEGATIVE</b>

- Employ a unified and streamlined development review process
- Develop simple and practical performance criteria
- Include all stakeholders in a public process to define the scope of watershed protection tools
- Be responsive to the needs of the development community for fair and timely review and "common-sense" requirements
- Provide incentives and remedies that protect the economic interests of existing landowners
- Continually tout the economic and environmental benefits that are expected from watershed protection
- Institute a dedicated funding source to support watershed protection such as a stormwater utility

The central role of local government leadership in watershed protection cannot be overstated, nor can the budget implications be discounted.

### Summary

The premise that carefully-managed watershed protection tools can have a balanced, positive effect on the local economy is generally supported by the economic research to date. It must, however, be acknowledged that our understanding of the economics of watershed protection is fragmented, and we know more about the parts than the whole. More economic research is urgently needed on the market and non-market benefits of an overall watershed protection program.

At first glance, it seems futile to calculate the intrinsic economic value of a quality stream, a productive cove, a clear lake, or a forested floodplain. Calculating the "true" value of a quality watershed, however it might be defined, seems an even more daunting task. Most economists would privately agree this can probably never be done. What is interesting about urban watersheds, however, is that society measures the value it places on these resources every day, in terms of property values, real estate premiums, lease-up rates, stormwater utility fees, construction costs and volunteer hours donated. While we may never know the true value of a stream, the research reviewed in this article clearly suggests that society does not value them lightly.

The timeless (and tired) real estate adage "location, location, and location" underscores the importance of how people value land. Research profiled here suggests that many of us prefer to locate next to forests, wetlands, streams and water features. More importantly, even those members of the community who do not live next to these features, still recognize the important role that they play in the quality of the environment and in their lives. Harnessing this sense of place is perhaps the most

important element of watershed protection programs.

—TRS

### References

- Adams, L. 1994. *Urban Wildlife Habitats—A Landscape Perspective*. University of Minneapolis Press. Minneapolis, MN. 175 pp.
- Anderson, L.M. and Cordell, H.K.. 1982 "Residential Property Values Improved by Landscaping with Trees." *Southern Journal of Applied Forestry* pp. 162-166.
- Arendt, R. 1994. *Designing Open Space Subdivisions: a Practical Step by Step Approach*. Natural Lands Trust. Appendix E. Medic, PA. 150 pp.
- Beaton, W. P. 1988. *The Cost of Government Regulations. Volume 2. A Baseline Study for the Chesapeake Bay Critical Area*. Chesapeake Bay Critical Area Commission. Annapolis, MD. 216 pp.
- Beaton, W.P. 1991. "The Impact of Regional Land Use Controls on Property Values: the Case of the New Jersey Pinelands." *Land Economics* 67(2): 172-94.
- Beaton, W. P. and M. Pollock. 1992. "Economic Impact of Growth Management Policies Surrounding the Chesapeake Bay." *Land Economics* 68(4): 434-53.
- Brown, W. 1996. "Toward a Balanced Monitoring Budget." *Watershed Protection Techniques* 2(1): 338-344.
- Burby, R. 1988. *Cities Under Water: A Comparative Evaluation of Ten Cities' Efforts to Manage Floodplain Land Use*. Institute of Behavioral Science #6. Boulder, CO. 250 pp.
- Chesapeake Bay Foundation. 1996a. *A Dollars and Sense Partnership: Economic Development and Environmental Protection*. Chesapeake Bay Foundation. Annapolis, MD. 21 pp.
- Chesapeake Bay Foundation. 1996b. *A Better Way to Grow: for More Livable Communities and a Healthier Chesapeake Bay*. Chesapeake Bay Foundation, Lands Program. Annapolis, MD. 32 pp.
- CH2M-Hill, 1993. *Costs of Providing Government Services to Alternative Residential Patterns. Committee on Population Growth and Development*. U.S. EPA Chesapeake Bay Program. Annapolis, MD. 168 pp.
- Clean Water Partnership. 1996. *Wetlands, Water Quality and Property Values*. Chain of Lakes brochure.
- Correll, Mark R., Jane H. Lillydahl and Larry D. Singell, 1978. "The Effects of Greenbelts on Residential Property Values: Some Findings on the Political Economy of Open Space." *Land Economics* 54(2).
- Desbonnet, A. P. Pogue, V. Lee and N. Wolff. 1994.

R0079631

## Protecting Property Rights and the Watershed

When a community applies some watershed protection tools, it faces conflict over the rights of the community versus the rights of private property owners. However, a well-crafted watershed protection program protects the rights of all members of the community, as well as the value of their land.

As noted earlier, many watershed protection tools generally have either an economically neutral effect on property value or increase it. For example, open space, forest conservation areas, creek and shoreline buffers and stormwater ponds all maintain the equity value of a parcel since they increase the value of developed properties.

The enhanced effect on land value is meaningless, however, if a property lies entirely within a protection zone and cannot be developed. For example, Holway and Burby (1990) found a sharp drop in the value of wetland and floodplain land when development was restricted. Similarly, Wood (1992) found that conservation easements that essentially prohibit any development or active management retain only 10 to 36% of their prior land value. Beaton (1991) reported that the value of undeveloped land in the most restrictive areas of the New Jersey Pinelands dipped slightly, but there were no wipeouts.

Fortunately, local governments have a number of techniques that can lessen the impact of protection zones on property owners. These include:

- *Transferable development rights* are a tool that achieve some of the same goals as conservation easements, in that another landowner may purchase the rights to develop a property from the owner. When the land is sold or inherited, it retains the prohibition against development. Several useful guides on how to create a TDR program to protect the rural landscape have been developed by Montgomery County, Pennsylvania (1995) and Montgomery County, Maryland (1990).
- *Clustering* allows the same number and type of lots as under existing zoning on a given parcel of land (e.g., single family detached homes), so potentially no equity value is lost. Cluster ordinances require that the total number of allowable lots be clustered on one portion of the entire parcel. Sensitive areas, buffers, and stormwater facilities are situated on the remaining undisturbed open space.
- *Density compensation* grants the landowner a credit for additional density elsewhere on the site, in compensation for developable land that has been lost due to a buffer or natural area requirement. Credits are then granted if more than 5% of developable land is lost, based on a sliding scale (Schueler 1995).
- *Voluntary conservation easements* protect sensitive areas and buffers with a mutually negotiated perpetual conservation easement that conditions the use and development of the land. The local government then taxes the protected land at a much lower rate, giving the landowner a lower property tax burden. There are also significant federal tax benefits (see Diehl and Barret, 1988).
- *Buffer and lot averaging* allows buffer and lot lines to be determined on an average rather than a fixed basis. This added flexibility allows designers to work around existing structures, and environmentally sensitive areas.

Other techniques to consider to protect property rights include grandfathering, traditional use exemptions, and a fair and timely appeals procedure (see also RMC, 1992). Kelly *et al.* (1996) have prepared a useful guide for planners to use in response to concerns about takings.

Finally, it is important to clearly frame each watershed protection tool within the compelling public safety, welfare, or environmental benefits that it provides to the community at large, so that the partial regulation of land use can be legally justified. For example, stormwater and erosion control requirements protect downstream properties from flooding and sediment damages (and claims) arising from upstream activity.

*Vegetated Buffers in the Coastal Zone: A Summary Review and Bibliography.* Coastal Resources Center, University of Rhode Island. Providence, Rhode Island. 72 pp.

Diehl, J. and T. Barret. 1988. *Conservation Easement Hamper.* The Land Trust Alliance. Trust for Public Land. Alexandria, VA.

Dinovo, C. E. 1995. "Stormwater Detention Basins and

Residential Locational Decisions." *Water Resources Bulletin* 31(3): 515-521.

Ebenreck, S. 1988. "Measuring the Value of Trees." *American Forest* 4(7&8): 31-64.

Flink, C., and R. Searns. 1993. *Greenways-- A Guide to Planning, Design and Development.* The Conservation Fund. Island Press. Washington, D.C. 338

- pp.
- Hanson, S., and R. Rowntree. 1988. *Influence of Urban Forest Cover on Radiation, Temperature, and Runoff in the Salt Lake Basin, Utah*. pp. 412-415.
- Hoban T., and W. Clifford. 1992. *Public Attitudes Toward Water Quality and Management Alternatives in the Ablemarle-Pamlico Estuary*. APES Report. 89-06. Ablemarle-Pamlico Estuary Program. Raleigh, NC.
- Holway, J., and R. Burby, 1990. "The Effects of Floodplain Development Controls on Residential Land Values." *Land Economics* 66: 259-271.
- Kelly, E.D., A. L. Strong and D. R. Mandelker. 1996. "The Longer View: Property Rights and Takings." *Journal of the American Planning Association* Winter 1996. In Press.
- Kirby, K. 1993. "Wetlands Not Wastelands." *Scenic America Technical Information Series* 1(5): 1-8
- Lacey, J., and R. Arendt. 1990. *An Examination of Market Appreciation for Clustered Housing with Permanently Protected Open Space*. Center for Rural Massachusetts, Amherst, MA. 14 pp.
- Legg Mason. 1990. *Real Estate Report on Cluster Development in Howard County, MD*. Unpublished report.
- Liptan, T. and C. K. Brown. 1996. *A Cost Comparison of Conventional and Water Quality-Based Stormwater Designs*. City of Portland. Bureau of Environmental Services. Portland, OR. 16 pp.
- Maryland Office of Planning. 1989. *Environmental and Economic Impacts of Lot Size and Other Development Standards*. Baltimore, MD. 18 pp.
- Michael, H. J., K. J. Boyle and R. Bouchard. 1996. *Water Quality Affects Property Prices: A Case Study of Selected Maine Lakes*. University of Maine, Maine Agricultural and Forest Experiment Station. Miscellaneous Report 398. 15 pp.
- Montgomery County Planning Board. 1990. *Plowing New Ground: Questions and Answers*. Agricultural and Rural Open Space Preservation Program. Montgomery County, MD. 19 pp.
- Montgomery County Planning Commission. 1995. *Guidebook for Creating a Municipal TDR Program*. Montgomery County, PA. 62 pp.
- Morales, D.J. 1980. "The Contribution of Trees to Residential Property Values." *Journal of Arboriculture* 6(11):301-302.
- National Association of Homebuilders (NAHB). 1986. *Cost-Effective Site Planning--Single Family Development*. Washington, D.C. 124 pp.
- National Park Service, 1992. *The Economic Impacts of Protecting Rivers, Trails and Greenway Corridors*. National Park Service, Western Regional Office. San Francisco, CA. 100 pp.
- National Small Flows Clearinghouse, (NSFC). 1995. "Maintaining Your Septic System--A Guide for Homeowners." *Pipeline* 6(4): 1-B. Septic Systems.
- Nelson, W. 1975. "Trees in the Landscape: A Look Beyond the Obvious." *Journal of Arboriculture* 1:121-128.
- Ohrel, R. 1995. "Dealing With Septic System Impacts." *Watershed Protection Techniques* 2(1) 269-27.
- Paterson, R., M. Luger, R. Burby, E. Kaiser, H. Malcom and A. Beard. 1993. "Costs and Benefits of Urban Erosion and Sediment Control--The North Carolina Experience." *Environmental Management* 17 (2) 167-178.
- Resource Management Consultants (RMC). 1992. *Incentives and Their Uses in the Chesapeake Bay Critical Area*. Chesapeake Bay Critical Area Commission. Annapolis, MD. 94 pp.
- Schueler, T. 1995. *Site Planning for Urban Stream Protection*. Center for Watershed Protection. Metropolitan Washington Council of Governments. Silver Spring, MD. 222 pp.
- Streiner, C. and J. Loomis. 1996. *Estimating the Benefits of Urban Stream Restoration Using the Hedonic Price Method*. Dept. of Agriculture and Resource Economics. Colorado State University. 18 pp.
- Suburban Maryland Building Industry Association, (SMBIA). 1990. Unpublished data on the unit cost of residential subdivision development in Suburban, Maryland.
- U.S. EPA. 1992. *Stormwater Utilities: Innovative Financing for Stormwater Management*. Office of Policy, Planning and Evaluation. Washington, D.C. 92 pp.
- U.S. EPA. 1993. *Guidance for Specifying Management Measures for Sources of Nonpoint Pollution in Coastal Waters*. Office of Water. EPA 840-B-92-002. Washington, D.C. 740 pp.
- U.S. EPA. 1995. *Economic Benefits of Runoff Controls*. Office of Wetlands, Oceans and Watersheds. Washington, D.C. EPA 841-5-95-002. 19 pp.
- Weyerhaeuser Company, 1989. *The Value of Landscaping*. Weyerhaeuser Nursery Products Division. Tacoma, WA.
- Wiegand, C., T. Schueler, W. Chittenden, and D. Jellick. 1986. *Cost of Urban Runoff Quality Controls*. pp. 366-380 In: *Urban Runoff Quality*. Engineering Foundation Conference. ASCE. Henniker, NH, June 23-27. 1986.
- Wildlife Habitat Enhancement Council. 1992. *The Economic Benefits of Wildlife Habitat Enhancement on Corporate Lands*. Silver Spring, MD. 22 pp.
- Wood, T.C. 1992. "Effect of Conservation Easements on Fair Market Values." *Maine Coast Heritage Trust. Technical Bulletin 104*.

# Microbes in Urban Watersheds: Implications for Watershed Managers

**W**hen it comes to bacteria, most watershed managers have more questions than answers. Can a beach, shellfish or drinking water use really be maintained in the face of watershed growth? Can water contact recreation uses ever be supported in an urban watershed, and under what flow conditions? What expectations are reasonable for future water uses? What kind of detective work is needed to discover existing bacteria sources? Which bacteria sources are the best targets for management? What watershed practices are most effective in preventing or treating new sources? Eliminating or treating existing sources? What kind of bacteria monitoring is needed to safeguard public health?

Some of the answers to these difficult questions depend on many complex watershed factors, such as the density of development, method of sewage disposal, bacteria sources, actual water uses and weather conditions. Given that watershed managers are increasingly asked to control microbes, this article seeks to present a more coherent framework for how bacteria can be managed in urban watersheds. It begins by describing a conceptual model for managing bacteria in urban watersheds, and then applies the general model to four specific watershed types. The implications for bacteria management in each watershed type are reviewed in detail, with a strong emphasis on the prevention and treatment of new bacteria sources. The last section presents a six-step process to detect existing urban bacteria sources, as well as a review of practices that can eliminate or treat these sources.

## The Bacteria Management Model

Not much is out there to guide watershed managers on how to manage bacteria. To begin to fill this gap, we have developed a general bacteria management "model." It is a simple framework that organizes what we know (or think we know) about managing bacteria in different kinds of urban watersheds. The model is a still work in progress, and many of its details need to be confirmed by more research data. It is best regarded as an initial hypothesis rather than a predictive model at this point. Still, it represents a starting point to guide debate on what we can expect to achieve in managing bacteria in urban watersheds (Figure 1).

The bacteria management model distinguishes two broad kinds of human uses: *consumption* as in drinking

water and shellfish harvesting, and *contact* such as swimming and other forms of water contact recreation. The model also evaluates use impairments in four kinds of watersheds, based on their density and primary wastewater disposal technique. The watersheds include the following:

- *Very low density watersheds.* These watersheds are essentially undeveloped or rural in character and have less than 5% impervious cover. Septic systems are used for wastewater disposal, but occur at a relatively low density. As a result, livestock and wildlife constitute the primary bacteria sources.
- *Low density watersheds.* While portions of these watersheds remain undeveloped or in rural uses, they are primarily zoned for large lot residential development, which are serviced by individual septic systems. Lot sizes can range from one to five acres. Impervious cover typically ranges from five to 15%, and the density of septic systems frequently exceeds 100 per square mile. Septic systems and stormwater runoff are key sources.
- *Moderate density watersheds.* The land use in these watersheds is primarily suburban in nature. Residential and commercial developments are serviced by sanitary sewers. Impervious cover ranges from 15 to 30%. Stormwater runoff, pets and sanitary sewer overflows are key sources.
- *High density watersheds.* These watersheds are highly urban in character, and wastewater is disposed by a sewer system. Depending on its age and condition, the sanitary sewer system may be a bacteria source, either from combined sewer overflows, sanitary sewer overflows, illicit sewage flows or some combination thereof. Impervious cover in these highly urban watersheds exceeds 30%.

The model projects the frequency of use impairments under dry weather and wet weather flow conditions for each of the four kinds of watersheds, as defined by an exceedance of fecal coliform standards. The impairment curve is expressed as a band, to reflect the variability in watershed sources and the use of management practices which reduce bacteria.

### CONSUMPTIVE USES

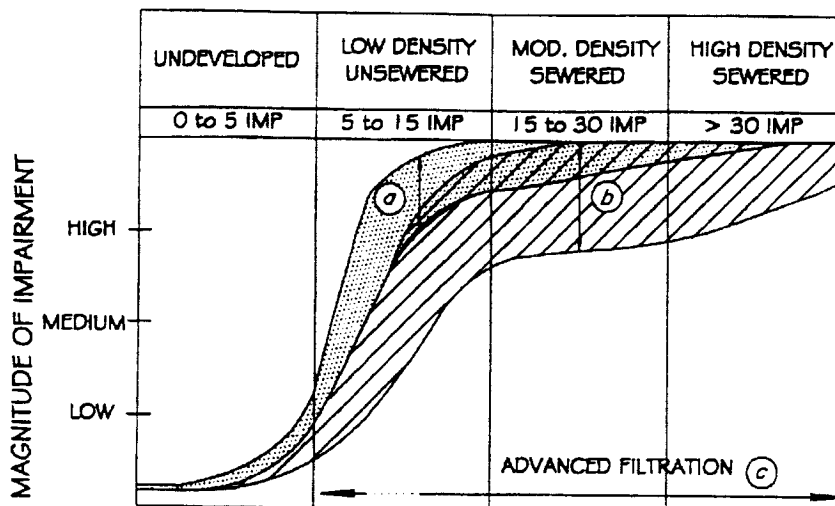

### CONTACT USES

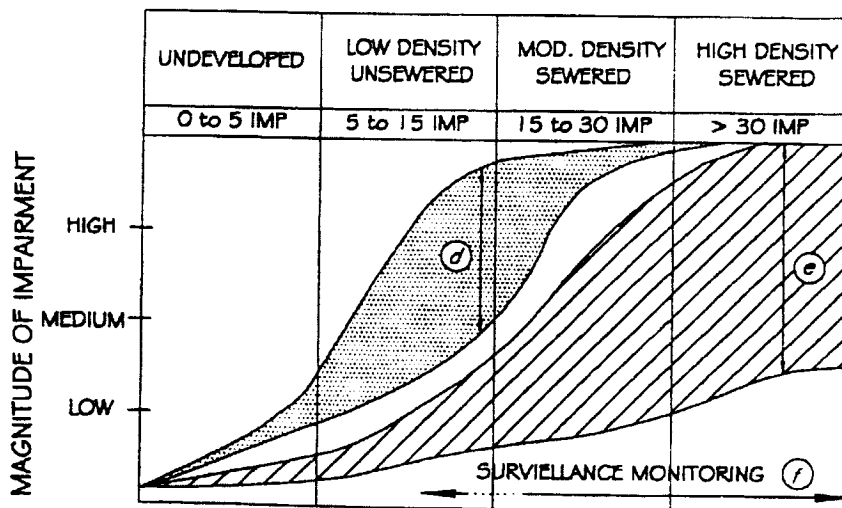

The bacteria management model "predicts" the degree of use impairment for four kinds of urban watersheds for consumptive uses such as drinking water and shellfish harvesting (top panel). Frequent impairment is projected during both wet and dry weather conditions. The wet weather impairment curve (a) climbs steeply and is relatively narrow. The dry weather curve (b) also climbs steeply, but is much broader, indicating the potential impact of watershed management. Given the high probability of impairment, advanced filtration is recommended to treat drinking water in all but the most lightly developed urban watersheds (c).

Less impairment is projected for recreational contact uses (bottom panel), with greater impairment noted during wet weather conditions (d) than dry weather conditions (e). The dry weather impairment curve (e) is very wide, suggesting that watershed management measures can have a strong impact on uses. As the density of development increases, however, communities must institute more intensive surveillance monitoring to protect public health (f).

**Figure 1: Conceptual Model for Bacteria Management in Urban Watersheds**

In general, the model suggests that very few *consumptive uses* of water can be maintained during wet-weather conditions. The narrow width of the wet weather curve indicates that even when watershed practices are widely implemented (e.g., stormwater treatment, buffers and source controls), frequent impairment of uses can still be expected. While consumptive uses can also be impaired during dry weather, the impairment curve is much wider. The width of the dry weather curve reflects how aggressively human sewage sources are inspected, detected and corrected within a given subwatershed (e.g., septic systems, illicit connections, SSOs and CSOs). The low range of the curve indicates systematic efforts to detect and correct sewage discharges, whereas the high range indicates little or no watershed effort.

The model also indicates that advanced filtration and disinfection are needed to maintain the purity of drinking water in nearly all urban watersheds. Watershed practices are useful in enhancing the effectiveness and reliability of drinking water treatment processes, but cannot, by themselves, protect a water supply in the absence of filtration.

The second panel portrays the impairment curves for *water contact recreation*, such as swimming, wading and boating. Once again, the wet weather impairment curve is very steep, with frequent impairment occurring in moderate and high density watersheds. In this case, the wet weather impairment curve is somewhat wider, suggesting that aggressive implementation of watershed practices can prevent impairment in low density watersheds (e.g., stormwater treatment, buffers, and source controls). The width of the dry weather impairment curve is expected to be much broader, which again suggests aggressive efforts to detect, inspect and correct human sewage discharges within a watershed (e.g., septic systems, illicit connections, SSOs or CSOs) could sharply reduce impairment during dry weather.

From the standpoint of water contact recreation, the model suggests that aggressive efforts to implement watershed practices and eliminate sewage sources can sharply reduce the frequency of bacteria impairments for many kinds of urban watersheds. As watersheds become more urban, however, communities are advised to monitor their waters more frequently, and institute a better notification system to ensure that the public is aware when water uses such as swimming are permitted or prohibited. If routine monitoring is not possible, communities should consider automatic closure of urban waters for water contact recreation during storms and for several days thereafter.

### Applying the Model to Real Watersheds

Several bacteria management strategies make sense under all urban watershed conditions. These include the following:

- *Target human sources of pathogens first.* Pathogens from untreated sewage are potentially more dangerous and more controllable than bacteria generated from nonhuman sources delivered in urban stormwater runoff.
- *Attack dry weather bacteria problems next.* The bacteria management model clearly indicates that the greatest range in impairment frequency occurs during dry weather, so that attacking these sources should yield the greatest watershed management benefit. Recreational uses are also more prevalent during dry weather.
- *Adapt bacteria management strategies for unique watershed conditions.* Every watershed has a unique combination of density, impervious cover, sewage disposal methods, bacteria sources and water use, and therefore a single approach to managing bacteria is likely to fail. Four approaches for managing bacteria, based on the four types of watersheds are presented later in this article.
- *Progress from the watershed to the subwatershed to the source.* Watershed managers need to perform watershed detective work to discover existing bacteria sources—to find out exactly where, when and how bacteria are getting into surface waters. A simplified six-step watershed screening process is provided later in this article to help managers track down individual and controllable bacteria sources.
- *Correct existing bacteria sources first.* Existing bacteria sources that are so hard to detect should be the highest priority for correction, particularly since regulatory tools exist to eliminate or treat these sources.
- *Prevent or treat future bacteria sources.* New development creates the potential for new bacteria sources, in the form of stormwater runoff, discharge from failing septic systems or sewers. A key goal in every watershed management plan should be to keep bacteria discharges from new sources as close to zero as current technology and maintenance allows. Guidance on preventing or treating future bacteria sources are provided in Table 1, and is described in greater detail for each of the four watershed types in the next section.

### Managing Bacteria in Very Low Density Watersheds

As noted earlier, very low density watersheds are essentially rural watersheds with 5% impervious cover or less. Septic systems are used for wastewater disposal, but because of their very low density, there are very few of them in the watershed. Livestock can be a significant bacteria source if dairies or confined animal feeding operations (CAFOs) are present and are not

**Table 1: Practices to Prevent or Treat Future Bacteria Sources**

Low density watershed	Moderate to high density watershed
<p>Land use management</p> <p>Septic system feasibility criteria</p> <p>Septic system technology criteria</p> <p>Septic system reserve field requirements</p> <p>Septic system setback requirements</p> <p>Minimum lot size for septic system</p> <p>Local septage maintenance authority</p> <p>Stream buffers and access restrictions</p> <p>Livestock fencing</p> <p>Wildlife control</p> <p>Land application criteria for biosolids</p> <p>Stormwater treatment for new development</p> <p>Public education</p> <p>Recreational sewage pump out facilities</p>	<p>New sewer testing</p> <p>Inspection of new sewer hookups</p> <p>SSO monitoring and prevention</p> <p>Stormwater treatment for new development</p> <p>Optimal stormwater outfall location</p> <p>Engineered stream buffers</p> <p>Pet exclusion</p> <p>Waterfowl control/management</p> <p>Public education on pet waste</p> <p>Transient sewage disposal</p>

managed properly. Wildlife can also contribute to background levels of bacteria.

- *Use attainment.* Generally speaking, very lightly developed watersheds can meet most consumption and contact uses most of the time. Occasional standard violations can be expected due to wildlife or livestock sources. Disinfection is needed for drinking water supplies, but it may be possible to avoid advanced filtration if animal production does not occur in the watershed.
- *Preventing future bacteria sources.* Restrictions on land development are a time-honored bacteria prevention strategy. Water utilities have long recognized that land use control is one of the most effective strategies to protect surface drinking water supplies, particularly if they are unfiltered. Numerous water utilities have acquired extensive lands within a contributing watershed and manage them in a forest condition, to reduce the potential for future human bacteria sources due to watershed development. Significant portions of contributing watershed land has been acquired to protect unfiltered water supplies for Boston, New York, Seattle and Portland.

Land acquisition was rated the most effective and reliable tool to protect the quality of surface drinking water supplies, according to a detailed national survey of water utilities and drinking water regulators (Gibbons *et al.*, 1991). Nearly a quarter of all water utility companies acquire watershed land as a prevention strategy. The survey respondents ranked land acquisition as the

most effective of 20 watershed management tools for protecting waters supplies.

Other highly rated watershed management tools were watershed entry restrictions, prohibition of certain types of development, and restrictions on impervious cover. It is interesting to note that the survey respondents were not very confident about urban stormwater practices as a watershed management tool, ranking them as the 15th most effective management tool.

Other common prevention strategies for very low density watersheds are more stringent septic system requirements (e.g., setbacks, reserve fields and soil suitability criteria) as well as the use of stream or shoreline buffers. Fencing may be advisable if livestock are present and an alternative water supply can be provided. In addition, recreational facilities such as marinas and campgrounds should be designed with sewage pumpout facilities to prevent illegal sewage discharges.

The primary goal of a monitoring program for a very low density watershed is to establish a network of surveillance stations to track trends in fecal coliform over time. These stations can provide watershed managers "early warning" about future bacteria problems.

*Managing Bacteria in Low Density Watersheds*

While portions of these watersheds remain undeveloped or in rural uses, they are primarily zoned for large lot residential development, which are serviced by individual septic systems. Lot sizes can range from one to five acres. Impervious cover typically ranges from



five to 15%, and the density of septic systems frequently is greater than 100 per square mile

- *Use attainment.* While the low density strategy can be an effective form of land use control, it does not necessarily prevent use impairment. The bacteria management model (Figure 1) assumes that low density subwatersheds exhibit a wide potential impairment curve during wet weather. The relatively wide range in the impairment curves indicates that frequent use attainment might be possible if effective watershed practices are widely implemented (e.g., stormwater treatment, buffers and source controls) and if septic systems exhibit a very low failure rate in the subwatershed. If, on the other hand, watershed practices are poorly implemented, or not implemented at all, then routine impairment can be expected during wet weather conditions. Dry weather contact uses, however, can be attained most of the time in low density watersheds. Disinfection and advanced filtration are generally needed to assure the purity of surface drinking water supplies in low density watersheds, primarily due to the risk of *Cryptosporidium* and *Giardia* which can be resistant to traditional forms of water treatment.

- *Preventing new bacteria sources.* The choice to limit development to large lot residential zones in low density watersheds is a form of land use control. Commercial and industrial land uses are excluded from these watersheds since they generally require sewer service to handle their higher wastewater flows. The key prevention strategy in low density watersheds is to prevent residential septic systems from failing (i.e., to maintain the failure rate as close to zero as current technology and management allow). Consequently, communities should consider imposing very stringent controls on new septic systems that cover their design, soil suitability, setbacks, inspection and maintenance provisions.

It is also advisable to set back development a fixed distance from shorelines and streams, to alter drainage patterns to direct runoff to less sensitive outfall locations (i.e., fixed distance from a water intake or beach, or to a zone of greater mixing or dilution) and implement conservation practices on hobby farms. Stormwater practices can also be an important treatment strategy for low density watersheds. Stormwater practices should emphasize those designs that can achieve a high rate of bacteria removal and do not create internal bacteria reservoirs in the drainage system.

The success of a low density strategy stands or falls on the ability to prevent septic system failure. Thus, from a monitoring standpoint, communities should augment their early warning stations at key water use

areas with routine monitoring of the performance of new and existing septic systems in the watershed. Several communities have found that a local or regional septic system authority is very helpful in assuring compliance for the thousands of individually owned and operated systems within a watershed. Such an authority has the financial resources to rehabilitate failed systems or connect them to sanitary sewers, particularly at clusters of failed systems located near riparian, lakefront or coastal locations that are closest to water uses.

#### *Managing Bacteria in Moderate Density Watersheds*

The land use in these watersheds is primarily suburban in nature. Residential and commercial development are serviced by sanitary sewers. Impervious cover ranges from 15 to 30%. The moderate density strategy seeks to prevent future bacteria sources caused by widespread septic system failure by connecting homes and businesses to a sanitary sewer collection system. This system is managed by a local wastewater authority that has the resources to effectively remove human sewage from the watershed equation, by providing more effective treatment and pumping it to a less sensitive discharge point. Most significantly, the wastewater authority is governed under the NPDES program so that operation and maintenance of the plant and its collection system can be monitored and enforced.

- *Use attainment.* The moderate density strategy supports a greater population density within a watershed, which in turn, increases the amount of impervious cover, pets, urban wildlife, and "improved drainage" that can become new and possibly uncontrollable bacteria sources. Consequently, moderate density often results in frequent impairments during wet weather, which leads to temporary closure of waters for swimming and water contact recreation. As might be expected, surface water supplies located in moderate density watersheds typically require more expensive treatment processes to assure the purity of drinking water. Stormwater outfalls to shellfish beds will inevitably result in permanent closure, unless unusual flushing or dilution are present.

- *Preventing new bacteria sources.* Urban stormwater becomes a major bacteria source in moderate density watersheds. Consequently, stormwater practices, engineered buffers, and source controls should be applied to all new development in order to reduce bacteria concentrations. As previously stated, however, these watershed practices are generally not sufficient to meet bacteria standards. Accordingly, in order to meet standards it may be necessary to also require new development to obtain bacteria reductions from existing watershed sources in the form of an offset. The offset could be a stormwater pond

retrofit or septic system rehabilitation at an existing development.

Lastly, the local sewer authority needs to be vigilant to prevent overflows and improper connections to any new sewer system that is constructed. This involves initial pressure testing, ongoing field inspection, faster spill response and hotline reporting procedures.

"Early warning" stations in a moderate density watershed will normally pick up violations of bacteria standards during dry-weather. More intensive bacteria monitoring is needed in these watersheds to alert managers when water uses can be reopened during dry weather. An excellent monitoring and public outreach program has been developed in the Charles River in Boston that combines rapid fecal coliform sampling and "red flags" to ensure that the users know when water contact recreation is permitted or prohibited. Other communities have resorted to automatic closure of urban waters during storms and for several days thereafter.

#### *Managing Bacteria in High Density Watersheds*

These watersheds are highly urban in character, and wastewater is collected by hundreds of miles of sanitary sewers. The sewer network often becomes a major source of bacteria through episodic discharges from combined sewer overflows, sanitary sewer overflows or illicit sewage flows. In addition, the high levels of impervious cover found in high density watersheds produce stormwater runoff that contains a spectrum of human and nonhuman bacteria sources. The urban drainage network is also very extensive and often contains internal bacteria "reservoirs."

- *Use impairment.* It can be presumed that all human water contact uses will be impaired by bacteria levels during wet and dry weather conditions in high density watersheds, unless very favorable dilution or mixing conditions are present in the receiving water. It is possible, however, to support some water non-contact recreation uses during dry weather, if bacteria sources are adequately managed within the extensive network of sanitary and storm sewers.
- *Preventing bacteria sources.* The primary bacteria management strategy in high density watersheds is to detect, eliminate or treat all potential bacteria sources within the extensive network of sanitary and storm sewers. Considerable detective work is needed to find out exactly where, when and how bacteria are getting into either collection system. In some situations, it may be desirable to construct end-of-pipe disinfection systems at key outfalls near important water uses. Source control is also an essential strategy for high density watersheds, particularly in regard to pet waste.

It is important to note that even though high density development greatly diminishes water uses, it is a critical element in a regional watershed approach. High density watersheds concentrate growth and related use impairment in a smaller geographic area than any other density strategy. Communities should implement extensive monitoring, posting and watershed education programs to limit the risk to public health in these watersheds.

#### **Detective Work to Find Existing Watershed Sources**

The sources and loads of most urban pollutants can be initially estimated for a watershed from a desktop or by a computer, given reasonably accurate land use and discharge permit information, requiring little in the way of additional watershed monitoring. This desktop analysis can be used to compare different pollutant sources, and ultimately be used to target watershed management practices.

In the case of bacteria, however, a desktop analysis is not particularly helpful, since actual bacteria sources must be discovered in the field. Watershed managers need to perform a lot of detective work to isolate existing bacteria sources and find exactly where, when and how bacteria are getting into surface waters. It is a lot like finding a whole bunch of needles in a haystack. Watershed managers must employ a variety of investigative techniques to discover the broken sewer pipe, the failed septic system, the hidden illicit connection, the concentration of wildlife, the overstocked hobby farm or the overflowing manhole.

This search requires at least two phases of watershed detective work. In the first phase, the lengthy list of possible bacteria suspects in each watershed must be whittled down to a manageable size. In the second, field investigations are needed to isolate the exact location of dozens or hundreds of individual bacteria sources so that they can be corrected.

Very few watersheds have been the target of such comprehensive detective work, given the enormous monitoring effort that it would entail. It is possible, however, to take some reasonable shortcuts when it comes to watershed detective work. With this in mind, we suggest a simplified six-step process to track down individual and controllable bacteria sources in a watershed.

#### *Step 1: Re-Analyze Historical Fecal Coliform Data*

Re-analyzing historical fecal coliform monitoring data sets is an excellent first step in any bacterial investigation. Historical coliform data from each monitoring station should be carefully segregated into dry and wet weather samples, and geometric means computed for both flow conditions. Samples from cold weather months should be excluded from the analysis.

Likewise, individual monitoring stations should be used to define bacteria conditions for subwatersheds within the watershed. Keep in mind that coliform bacteria data are notoriously variable and very hard to interpret, so at least a dozen samples are needed at each station. Once the geometric means are computed, they can be compared to dry and wet weather bacteria "benchmarks." It is also helpful to derive the 90% confidence intervals.

If fecal coliform samples have never been collected in the watershed, then new monitoring stations should be established at key subwatershed locations. For budgeting purposes, the cost of a year's grab sampling of fecal coliform will run about \$1,250 to \$2,500 per subwatershed station (Claytor and Brown, 1995).

*Step 2: Compare to Urban Watershed Benchmarks*

The bacteria benchmarks are not meant to be standards, but rather a comparative gauge to help watershed managers rank the severity of bacteria problem in different subwatersheds or flow conditions. Subwatersheds that consistently exceed the benchmark are prime candidates for more intensive screening and field investigations. The two suggested bacteria benchmarks for urban watersheds are as follows:

- *Dry weather:* Fecal coliform levels exceed a geometric mean 500 MPN/100 ml in baseflow
- *Wet weather:* Fecal coliform levels exceed a geometric mean of 5,000 MPN/100 ml during storms.

These benchmarks were derived based on the following rationale. First, bacteria levels below each

benchmark are consistently observed in urban streams, and are capable of being solely supported by nonhuman bacteria sources in the watershed (pets, wildlife, waterfowl, or the urban drainage system). Second, the wet weather benchmark generally corresponds to fecal coliform levels that are achieved by current stormwater treatment practices. Third, and most importantly, bacteria concentrations above either benchmark suggest (but do not prove) that *human* sources of bacteria could be present in the watershed, which are always the highest priority for detection and control.

The purpose of the benchmark analysis is to narrow the search to a manageable number of subwatersheds, and to determine whether dry weather and/or wet weather bacteria sources will be targeted.

*Step 3: Identify the Types and Locations of Water Uses*

In the third step, a watershed manager determines what kind of consumptive or contact uses are present in the subwatershed, and where they are located. While state water quality agencies are required to define permissible water uses for larger water bodies, and must periodically report on their status (i.e., 303(d) lists), they seldom have the monitoring resources to provide detailed information on actual water uses or impairment at the subwatershed level. Therefore, it is important to locate any water intakes, drinking water source areas, shellfish beds, beaches, public water access, or recreation areas that may be present in the watershed. This simple step helps identify the specific use areas that need to be protected in the future, but also existing use impairments in the subwatershed.

**Table 2: Characterizing Potential Bacteria Sources in a Watershed**

Low density watershed	Moderate and high density watersheds
What is the percentage of impervious cover in the subwatershed?	What is the age, condition and capacity of the sewer system?
How many septic systems are present in the watershed? How old are they?	What is the length of the sewer system?
Under what feasibility, setback, and design standards were they built?	What is the percentage of impervious cover for the subwatershed?
What proportion of the watershed is not suitable or marginal for septic treatment?	Have SSOs been reported in the subwatershed?
Are septic systems clustered near receiving waters (along shorelines or streams)?	Are CSOs present in the subwatershed?
Are livestock or hobby farms present?	Are pet densities unusually high?
Are wildlife populations dense in water or riparian areas (beaver, gulls, geese)?	Are urban wildlife populations unusually high or close to receiving waters?
	What is the level of "urban housekeeping" in the watershed?
	Are there any transient sewage sources?

R0079640

#### *Step 4: Screen Potential Bacteria Sources*

If bacteria levels exceed a benchmark, then the next step in the detective work is to get the best leads on the most likely bacterial sources in the watershed, based on its specific characteristics. Table 2 outlines a series of questions to characterize bacteria sources in a watershed depending on whether sewers or septic systems are the predominant method of wastewater disposal. Watershed managers may need to consult many different agencies to fully answer the questions (e.g., wastewater operators, public health authorities, extension agents, animal control and wildlife agencies). It may also be necessary to analyze land use and soil suitability maps, and to verify conditions through a "watershed windshield survey." The outcome of this step is a narrower and more focused list of potential bacteria sources to investigate further.

#### *Step 5: Confirm Bacteria Sources Through Field Investigation*

The final step in the detective work involves systematic monitoring to isolate individual bacteria sources in the subwatershed. This can be an expensive and time-consuming step, so the search should be conducted in a sequential manner. The search should focus on specific investigations during dry weather conditions or wet weather conditions, depending on which benchmark has been exceeded in the subwatershed (see Tables 3 and 4). The search is designed to test for human sources first, under the assumption that these sources are potentially more dangerous and controllable than nonhuman sources.

#### *Step 6: Correct Priority Sources*

The previous step creates an "inventory" of the location and magnitude of individual bacteria sources in a watershed. In this step, watershed managers choose which strategies to eliminate or treat these existing bacteria sources. Some common watershed practices that can be used to control bacteria are provided in Table 5.

#### **What Do Standard Violations Really Mean?**

By now, the astute reader will have noticed that we have avoided the only question that seems to matter to the public and the media: *Is the water really safe or not?* Every watershed manager is eventually asked this question and the answer is vitally important. A negative answer can inflame fears and create negative perceptions about urban waters. A positive answer may create false expectations about public health. The true answer is quite equivocal: water safety depends on how and where we are exposed, whether we are using water for wading, drinking, swimming or harvesting shellfish, the infective dose, incubation period, and our health con-

dition. The specific answer to the safety question will be different for every urban watershed.

Researchers and managers continue to debate the question of the actual health risk from bacterial exposure in urban waters. A full discussion of this important debate is outside the scope of this article. The reader is referred to Pitt (1998), Francy *et al.* (1993), SMBRP (1996), Calderon and Mood (1991), Field and O'Shea (1992) and Seyfried *et al.* (1985) for excellent historical perspectives and/or more recent epidemiological studies. Three points of consensus, however, have emerged over the last few years. First, urban stormwater has been directly associated with symptoms of disease in swimmers near stormwater outfalls (SMBRP, 1996). Second, for a number of reasons, *E. coli* is supplanting fecal coliform as the preferred bacteria indicator by many urban watershed researchers (Nuzzi and Barbarus, 1997; Francy *et al.*, 1993).

Lastly, if *E. coli* or some other indicator is eventually chosen to replace fecal coliform as the primary bacteria indicator, a mammoth research effort will be needed to understand the concentrations, sources and controllability of these new indicators in urban watersheds. It is perhaps because of these massive data gaps that so few states have shown any enthusiasm for switching away from fecal coliform in their water quality standards. As of last year, 44 states and territories still relied on fecal coliform in whole or in part for their recreational water quality standards (U.S. EPA, 1998).

The fact that regulators and scientists can't agree on exactly what fecal coliform violations signify in terms of public health doesn't answer the important safety question. What practical advice can a watershed manager give to those who use urban waters? Several common sense rules are provided below:

- Don't drink urban water unless you are confident that it has been suitably treated.
- Have your vet periodically test stool samples if your dog drinks from urban creeks.
- Don't consume any fish or shellfish that are harvested from urban waters unless you are certain that public health agencies have certified it as meeting standards. Even if the shellfish bed passes muster, it is still advisable to wait several days after storms.
- Wading and boating are usually safe if users take sensible precautions. In general, users should avoid urban streams during and shortly after storms, avoid head immersion, keep cuts and sores covered, wear shoes (to prevent contact with bacteria-rich bottom sediments) and rinse off after activity with an anti-bacterial soap.
- Swimmers should fully understand their watershed before taking the plunge. In particular, swimmers should refrain from swimming within

**Table 3: Dry Weather Detective Work for Different Watersheds**

Low density watershed	Moderate to high density watershed
<p>Dry weather channel survey (see article 125)</p> <p>Aerial survey of septic systems</p> <p>Conduct visual or tracer tests on suspected failing systems</p> <p>Investigate recreational and seasonal sewage dischargers (e.g., marinas, campgrounds, etc.)</p> <p>Do RNA testing to determine whether FC are of human or nonhuman origin</p> <p>Test ditch or channel sediments to see if they are a bacteria source or reservoir</p>	<p>Dry weather channel survey (see article 125)</p> <p>Test for illicit connections</p> <p>Check integrity of major trunk lines for cracks and leaks</p> <p>Check for historic and unconnected septic systems</p> <p>Do RNA testing to determine whether FC are of human or nonhuman origin</p> <p>Check ponds, lakes and impoundments for waterfowl concentrations</p>

**Table 4: Wet Weather Detective Work for Different Watersheds**

Low density watershed	Moderate to high density watershed
<p>Inspect septic systems for wet-weather failure</p> <p>Conduct extensive wet weather monitoring to isolate subwatershed hotspots</p> <p>Do RNA testing to determine whether FC are of human or nonhuman origin</p> <p>Sample runoff from suspected source areas (e.g., hobby farms and livestock areas)</p> <p>Test storm drain or channel sediments to see if they are a bacteria sink or source</p>	<p>Monitor any existing CSOs</p> <p>Check for chronic SSOs at specific manholes and/or pumping stations</p> <p>Conduct extensive wet weather monitoring to isolate watershed "hotspots"</p> <p>Do RNA testing to determine whether FC are of human or nonhuman origin</p> <p>Conduct intensive wet-weather monitoring to identify key source areas or subwatersheds</p>

**Table 5: Practices for Eliminating or Treating Existing Bacteria Sources**

Low density watershed	Moderate to high density watershed
<p>Rehabilitate failing septic systems</p> <p>Connect failing septic systems to sewer</p> <p>Increase septic system cleanouts</p> <p>Retrofit stormwater ponds</p> <p>Retrofit ditches as dry swales</p> <p>Waterfowl management</p> <p>Install recreational sewage pumpouts</p> <p>Implement conservation plans at hobby farms</p>	<p>Eliminate illicit connections to storm sewer</p> <p>Rehabilitate existing sewer system to eliminate SSOs</p> <p>Abate or disinfect CSOs if present</p> <p>Relocate storm outfalls</p> <p>Disinfect at the end-of-pipe</p> <p>Retrofit stormwater ponds</p> <p>Retrofit ditches as dry swales</p> <p>Waterfowl harassment</p> <p>Enforce pet waste disposal</p>

R0079642

two days of a large storm and avoid swimming near stormwater outfalls. Swimmers should consult a doctor if they experience rashes, ear itches, or gastrointestinal illness after swimming.

—TRS

### References

- Calderon, R. and E. Mood. 1991. "Health Effects of Swimmers and Nonpoint Sources of Contaminated Water." *International Journal of Environmental Health* 1:21-31.
- Clayton, R. and W. Brown. 1995. *Environmental Indicators to Assess the Effectiveness of Municipal and Industrial Stormwater Control Programs*. Center for Watershed Protection, Ellicott City, MD.
- Field, R. and M. O'Shea. 1992. "An Evaluation of the Bacterial Standards and Disinfection Practices Used for the Assessment and Treatment of Stormwater." *Advances in Applied Microbiology* 37: 21-40.
- Francy, D., D. Myers and K. Metzger. 1993. *Escherichia Coli and Fecal Coliform Bacteria as Indicators of Recreational Water Quality*. USGS Water Resources Investigation Report. 93-4083. Earth Science Information Center, Denver, CO.
- Gibbons, R., J. Gillicker, D. Bloem, and B. Niss. 1991. *Effective Watershed Management for Surface Water Supplies*. American Water Works Association and AWWA Research Foundation. Denver, CO. 402 pp.
- Nuzzi, A. and D. Barburus. 1997. "The Use of Enterococci and Coliform in Characterizing Bathing Beach Waters." *Journal of Environmental Health* 60(1): 16-27.
- Pitt, R. 1998. "Epidemiology and Stormwater Management." *Stormwater Quality Management*. CRC/Lewis publishers. New York, NY.
- SMBRP. 1996. *An Epidemiological Study of Possible Adverse Health Effects of Swimming in Santa Monica Bay. Final Report*. Santa Monica Bay Restoration Project. CA
- Seyfried, P., R. Tobin, N. Brown, and P. Hess. 1985. "A Prospective Study of Swimming Related Illness: Swimming Associated Health Risk." *American Journal of Public Health* 75(9): 1068-1070.
- U.S. EPA. 1998. *Bacteria Water Quality Standards for Recreational Waters (Freshwater and Marine): Status Report*. EPA-823-R-98-003. U.S. Environmental Protection Agency, Office of Water, Washington, D.C.

# Methods for Estimating the Effective Impervious Area of Urban Watersheds

by Roger C. Sutherland, P.E.

One of the most difficult and important parameters that must be estimated for accurate hydrologic analyses is the effective impervious area (EIA) of a watershed or basin of interest. EIA is the portion of the total impervious area (TIA) within a basin that is directly connected to the drainage collection system. EIA includes street surfaces, paved driveways connecting to the street, sidewalks adjacent to curbed streets, rooftops which are hydraulically connected to the curb or storm sewer system, and parking lots.

EIA is usually reported as a percentage of total basin or subbasin area. In traditional urban runoff modeling or hydrologic analysis, the EIA for a given basin is usually less than the TIA. However, in highly urbanized basins, EIA values can approach and equal TIA values.

The EIA of a basin is an important parameter in the rainfall/runoff process because it directly affects the volume of runoff. Many hydrological models assume all the precipitation that falls on impervious areas becomes direct runoff. In actuality, the precipitation falling on impervious areas which are not hydraulically connected to the drainage collection system does not always result in direct runoff. Impervious area that does not contribute directly to runoff should be subtracted from the total impervious area to obtain the *effective* impervious area, in order to get a more accurate estimate of runoff volumes.

## Determination of Effective Impervious Area

The methodology for determining EIA has been refined through three levels:

### 1. Direct measurement in the field

The direct measurement of EIA is a tedious exercise which is rarely undertaken since most consultants cannot afford its excessive labor cost. To actually measure the EIA of a basin, it is necessary to catalog and evaluate the effectiveness of the hydraulic connection between *each* of the impervious areas and the major collector systems. This extremely time consuming exercise is impractical for most drainage planning and design related activities.

### 2. Derivation from models run on gauging data

If a basin is gauged, the effective impervious area

can be estimated by employing a rainfall-to-runoff model like HEC-1 or SWMM to calibrate the EIA parameter. This calibration is performed by fixing reasonable estimates of the precipitation loss components for the pervious portions of the basin and impervious areas, then adjusting the value of EIA to correlate computed and observed runoff volumes. The calibration process should be undertaken for several observed rainfall events, with the final estimate of EIA representing the weighted average of those values calibrated for each individual storm.

### 3. Empirical equations derived from whole-basin or subbasin parameters

Empirical equations can be developed to compute realistic values of EIA based on physical basin parameters that are easy to estimate. For example, the United States geological Survey (USGS) developed estimates of EIA for over 40 watersheds throughout the metropolitan areas of Portland and Salem, Oregon (Laenen, 1980 and 1983). Working with this database, the USGS also developed an empirical equation to estimate EIA as a function of total impervious area.

It should be noted that the modeling technique used by the USGS lumped all of the precipitation excess into a single optimized percentage of the basin area that was assumed to be contributing runoff. This optimized value was defined as the effective impervious area. Working with these optimized values, the USGS (Laenen, 1983) developed the following equation:

$$EIA = 3.6 + 0.43(TIA) \quad (1)$$

Equation (1) has been found to work well for TIA values greater than 10% and less than 50% but provides unrealistic EIA values for TIA values outside of this range (i.e., more urbanized areas). In surface water management master planning, one commonly deals with *small subbasins* (i.e. 20 to 70 acres) in which the ultimate mapped impervious area can routinely exceed 50%, and may be as high as 90%.

Therefore, there is a need to develop a better relationship between TIA and EIA and several alternative equations based upon the USGS data have recently been developed to satisfy this need, known as the Sutherland Equations.

**R0079644**

The general form of the equation to describe the relationship between TIA and EIA is as follows:

$$EIA = A (TIA)^B \quad (2)$$

In Equation (2), A and B are a unique combination of numbers such that the following criteria are satisfied:

1. If TIA = 1 then EIA = 0%
2. If TIA = 100 then EIA = 100%

Based on the USGS calibrated values of EIA for all basins with TIA  $\geq$  4%, several empirical equations were developed to apply to various generalized conditions of subbasins which may be encountered in the drainage master planning process. The first equation presented below (Equation 3) provided the best fit for all of the TIA versus EIA data used in the analysis. The remaining equations were based primarily on engineering judgement and experience as related to the various subbasin conditions which affect EIA.

The Sutherland EIA Equations are as follows:

1. *Average basins* where the local drainage collector systems for the urban areas within the basin are predominantly storm sewered with curb and gutters, no dry wells or other drainage infiltration areas are known to exist, and the rooftops in the single family residential areas are not connected to the storm sewer or piped directly to the street curb.

$$EIA = 0.1 (TIA)^{1.5}, TIA \geq 1 \quad (3)$$

2. *Highly connected basins* where everything in Condition 1 applies except the residential rooftops are predominantly connected to the streets or storm sewer system.

$$EIA = 0.4 (TIA)^{1.2}, TIA \geq 1 \quad (4)$$

3. *Totally connected basins* where 100% of the urban area within the basin is storm-sewered, with all impervious surfaces appearing to be directly connected to the system.

$$EIA = TIA \quad (5)$$

4. *Somewhat disconnected basins* where at least 50% of the urban areas within the basin are not storm sewered, but are served by grassy swales or roadside ditches, and the residential rooftops are

not directly connected. Alternatively, Condition 1 may apply, but the basin is known to have a few dry wells or other infiltration areas.

$$EIA = 0.04 (TIA)^{1.7}, TIA \geq 1 \quad (6)$$

5. *Extremely disconnected basins* where only a small percentage of the urban area within the basin is storm sewered, or a large portion of the basin area (i.e. 70 percent or more) drains to dry wells or other infiltration areas.

$$EIA = 0.01 (TIA)^{2.0}, TIA \geq 1 \quad (7)$$

Figure 1 compares the Sutherland EIA Equations along with the original USGS Equation for the range of impervious data collected in Oregon. The variation in the 42 actual subbasin data presented in Figure 1 demonstrates the difficulty in accurately estimating the EIA of a drainage basin. It is imperative that the drainage planner or engineer performs some degree of on-site investigation of the basin to determine which EIA equation may apply to the given circumstance. The greatest strength of the Sutherland EIA Equations is their consistency in providing reasonable estimates of EIA over the entire range of TIA. Therefore, they can be used in the surface water management planning process to estimate the change in EIA which will occur as a basin becomes urbanized.

#### References

- Laenen, A. 1980. *Storm Runoff as Related to Urbanization in the Portland, Oregon - Vancouver, Washington Area*, U.S.G.S. Water Resource Investigations Open File Report 80-689.
- Laenen, A. 1983. *Storm Runoff as Related to Urbanization Based on Data Collected in Salem and Portland and Generalized for the Willamette Valley, Oregon*, U.S.G.S. Water Resources Investigations Open File Report 83-4143.

R0079645



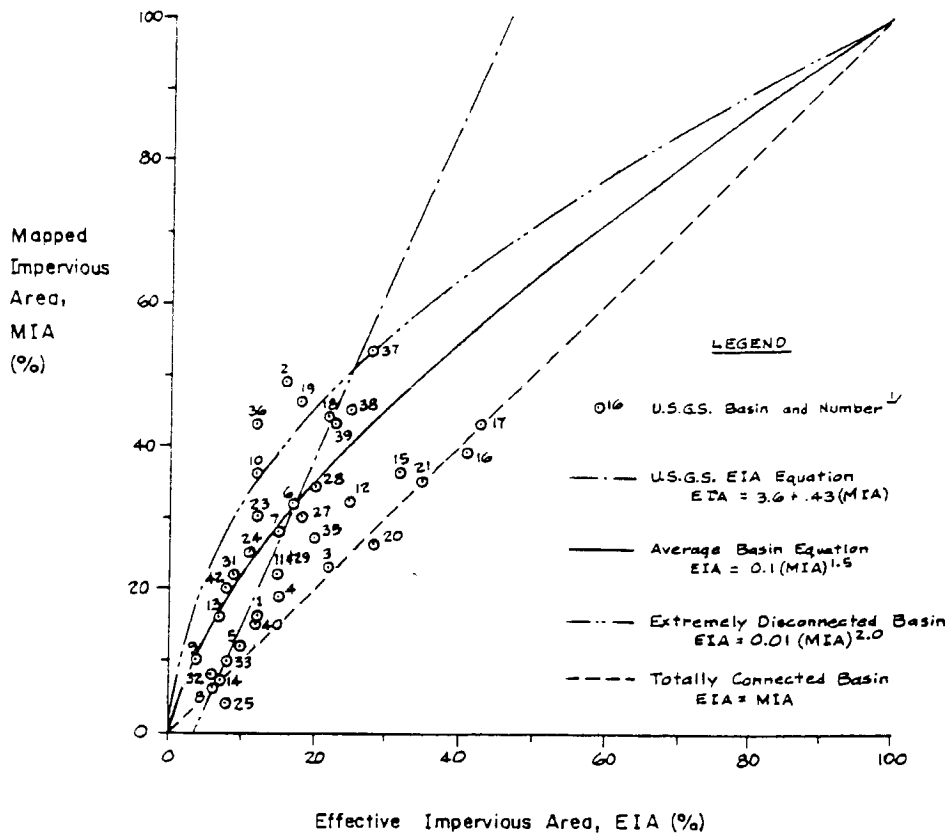

<sup>1/</sup> EIA values were based on a U.S.G.S. rainfall to runoff model study. Only points with MIA ≥ 4 were plotted (Laenen, 1980 and 1983).

**Figure 1: Plot of Sutherland Equations and USGS Equation That Illustrates Relationships Between Total and Effective Impervious Area for a Range of Watersheds**

3

R0079646

3

R0079647

# Section 4: Land Conservation

## Watershed Protection Tool #2

Conservation of natural areas is an integral element in the practice of watershed protection. Indeed, one of the first tasks in a watershed plan is to inventory key areas within the watershed that provide critical watershed services or functions, and then devise a way to protect them from future development through some combination of public or private sector land conservation. The range of potential areas that merit conservation in a watershed is staggering, depending on the ecoregion, terrain and human uses.

Consider for a moment the range of natural and cultural areas that watershed managers have sought to conserve in various parts of the country: tidal wetlands, prime farmlands, freshwater wetlands, old growth forest, springs, spawning areas in streams, rare or endangered species habitat, potential restoration areas, native vegetation areas, coves, inlets, pocosins, serpentine barrens, heron rookeries, flood plains, stream channels, seeps, steep slopes, littoral zones, caves, sinkholes, drinking water intake, well fields, shellfish beds, swimming beaches, recharge zones, archeological sites, trails, parkland, scenic view sheds, water access, old mills, bridges, green ways, and habitat corridors. Clearly, communities face hard choices not only in selecting which natural and cultural areas will be conserved in a watershed, but also the most appropriate land conservation tools with which to protect them (e.g., regulation, acquisition, conservation easements, education, etc.). Watershed managers typically look at five different types of conservation areas that may merit special management. These five types of conservation areas are described in considerable detail in article 27, and are outlined below:

*Critical Habitats* that provide essential habitat for plant and animal communities or populations.

*Aquatic Corridors* where land and water meet and whose interaction shapes the aquatic ecosystem.

*Hydrologic Reserves* that maintain the pre-development hydrologic response of a watershed by providing natural infiltration, interception, evapotranspiration and natural storage of rainfall. These reserves include forests, meadow, prairie or wetlands.

*Water Pollution Hazards*, which are particular land uses or activities in the watershed that pose a greater potential risk of pollution or contamination and must be therefore be set-back, restricted or even excluded from the watershed to reduce that risk.

*Cultural Areas* are those common areas that we use in the watershed, and which provide a sense of place in the landscape.

Regrettably, *Techniques* has paid little attention to land conservation over the years, with only a half dozen articles included for this volume, most of which are confined to research on the direct impacts urban stormwater on natural areas, or the compaction of urban soils. The reader is encouraged to consult the many excellent references and resources published in recent years on land conservation to learn how this important tool can be applied for watershed protection.

"The range of potential areas that merit conservation in a watershed is staggering."

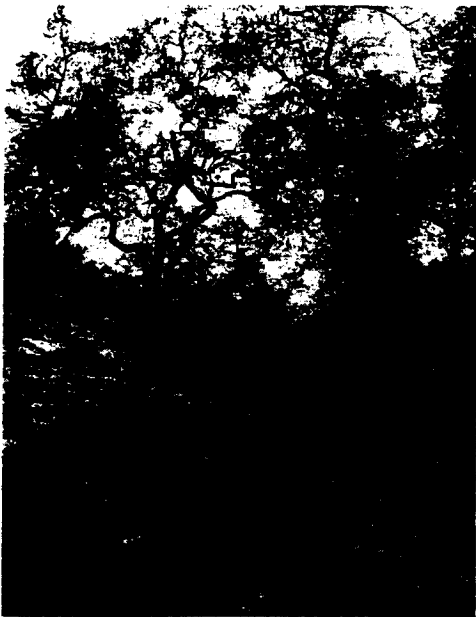

R0079648

cal habitats for plants and animals. National organizations, such as the Nature Conservancy and the Conservation Foundation, and their local counterparts have protected tens of millions of acres of key habitat. Early on, land trusts tended to protect smaller habitat parcels rather than larger watershed units. In recent years, however, land trusts have extended the scope of their land conservation efforts to encompass the larger watershed units that so strongly influence individual habitat parcels. It is clear that watershed managers should encourage this trend, and enlist the skills of land trusts to conserve the most important lands in the watershed.

Land conservation efforts have also been enhanced by better resource mapping and improved conservation area inventories, which are now available in most watersheds. In addition, the use and funding for conservation easements has become more widely accepted in recent years. Lastly, a number of communities have adopted local regulations to prevent or restrict development in their most important conservation areas, and these have generally withstood legal challenge.

#### *Research Needs in Land Conservation*

Several research efforts are needed to provide greater support for the land conservation tool. First, greater efforts are needed to define the nature and economic value of watershed services provided by individual conservation areas. Second, additional studies are needed to determine the impact of urban stormwater on the function and quality of individual conservation areas. As the articles in this section suggest, our watershed management strategies may need to incorporate these concerns in order to protect our most important conservation areas. Third, both landscape-level research and watershed models are needed to characterize and manage the conservation areas known as hydrologic reserves. In particular, we need to understand the hydrologic response of different pervious lands in the watershed, and whether it is indeed possible to improve watershed conditions by changing their vegetative cover (e.g., converting turf to forest). Better management of hydrologic reserve areas may well become a critical element of future watershed protection and restoration efforts.

### **Land Conservation Contents**

33.	Impact of Stormwater on Puget Sound Wetlands .....	199
34.	Loss of White Cedar in New Jersey Linked to Stormwater Runoff .....	205
35.	Wetter Is Not Always Better: Flood Tolerance of Woody Species .....	207
36.	The Compaction of Urban Soils .....	210
37.	Can Urban Soil Compaction Be Reversed .....	215
38.	Choosing Appropriate Vegetation for Salt-Impacted Roadways .....	219

# The Impact of Stormwater on Puget Sound Wetlands

**W**atershed managers have frequently questioned whether natural wetlands should be used for stormwater treatment. At the same time, wetland regulators have wondered whether upstream development and stormwater runoff might have a negative impact on the quality of natural wetlands. Until recently, these questions were largely theoretical, since very little research had been conducted on the influence of stormwater on wetlands. However, a series of recent research studies from the Pacific Northwest has shed new light on this topic.

A consortium of agencies and universities undertook an intensive eight-year study to investigate the consequences of watershed development and stormwater runoff on freshwater palustrine wetlands in the Puget Sound lowlands ecoregion. The consortium, formally known as the Puget Sound Wetlands and Stormwater Management Research Program (PSWSRP), evaluated how five major structural components of wetlands—hydrology, water quality, soils, plants, and animals—responded to watershed urbanization. Palustrine wetlands were selected because they have historically been altered more than other wetland types in the Puget Sound lowland ecoregion. Palustrine wetlands are freshwater systems that are in headwater areas or isolated from other water bodies and typically contain a mix of open water and other vegetation zones.

The 19 palustrine wetlands studied were relatively small (ranging from 1.5 to 31 acres in surface area) and had contributing watersheds that ranged from 87 to 886

acres in area. The wetland plant communities at the study sites were quite diverse. About 26% of the study wetlands were classified as scrub-shrub wetlands, 16% were forested wetlands, 13% were emergent and 5% were bogs or fens. The remaining 40% of wetlands studied were a mix of more than one of these wetland community types.

The study wetlands differed sharply in the amount of development that had occurred in their contributing watersheds, as defined by the indicator of total impervious cover. The wetlands were roughly split according to whether they were largely undeveloped (less than 4% impervious cover), moderately developed (four to 20%) and highly developed (more than 20%). The largely undeveloped wetlands were used as a reference to define the “best attainable” conditions for wetlands within the ecoregion. It should be noted that some of the wetlands experienced rapid growth during the eight years of study, while others remained relatively stable. A detailed summary of the study design and sampling methods used to investigate the wetlands can be found in Azous and Horner (1997).

### *Hydrology*

Wetland hydrology is often described in terms of its hydroperiod: the pattern of fluctuating water levels due to the complex interaction of flow, topography, soils, geology, and groundwater conditions in the wetlands. One of the key characteristics of the undeveloped reference wetlands was that they had relatively



**Table 1: Key Factors that Influence Water Level Fluctuation (WLF) in Puget Sound Wetlands**

Factor	Range	Mean WLF (feet)	No. of Observations
Forest Cover	No forest cover	1.15	97
	More than 15% cover	0.45	224
Impervious Cover	Less than 3.5%	0.32	105
	3.6 to 20%	0.53	143
	22 to 55%	1.43	73
Outlet Constriction	Low or moderate	0.44	198
	High	1.02	123
Wetland to Watershed Area Ratio	Less than 5%	0.91	169
	More than 5%	0.39	152

**R0079650**

**Table 2: Median Water Quality Concentrations in Wetlands with Different Levels of Urbanization**

Water Quality Parameter	Non-Urbanized Wetlands (N=206)	Moderately Urban Wetlands (N= 177)	Highly Urban Wetlands (N=66)
pH	6.4	6.7	6.9
Conductivity	46	160	132
TSS	2.0	2.8	4.0
NH3-N	21	43	32
NO3 + NO2	112	304	376
TP	29	70	69
Fecal Coliforms	9	46	61
Zinc	5	8	20

all units in ug/l, except conductivity (uS/cm), TSS (mg/l), and fecal coliform (cfu/100 ml)

low water fluctuations after storm events. Early work by Chin (1996) found that more developed wetlands had a higher water level fluctuation (WLF) after storms, and that this variable was an important overall indicator of the hydroperiod of a wetland. During the course of the study, the team frequently measured the WLF at each wetland site, defined as the average difference between maximum depth and the base depth on a crest stage gage.

Four watershed factors were found to strongly influence the WLF in a wetland (Table 1). The first two factors were strongly interrelated. When watershed forest cover was absent or total impervious cover was high, mean water level fluctuation frequently exceeded a foot or more in the wetland. More specifically, two impervious cover thresholds were identified. The first WLF threshold started at about 4% impervious cover, and corresponded to large lot rural development that began to clear forest cover and alter natural drainage patterns. The second and more significant WLF threshold occurred at about 20% impervious cover, at which point upstream development increased the peak and volume of stormwater runoff, and began to dominate the hydroperiods of downstream wetlands.

The third factor that contributed to a high WLF was the degree of constriction at a wetland's outlet. Wetlands that had constricted outlets (such as an undersized culvert or embankments) tended to have a greater WLF than wetlands with less constricted outlets (primarily due to backwater effects). The fourth key factor that influenced WLF was the wetland-to-watershed area. Wetlands that were small in relation to their contributing watershed had a greater WLF, and tended to be more dominated by surface inflow. Wetlands that were relatively large in comparison to their contributing

watersheds had a smaller WLF, and tended to be more influenced by groundwater.

The study team found that water levels tended to fluctuate by only a few inches in undeveloped wetlands, whereas developed wetlands frequently experienced water fluctuations of a foot or more. But how does a greater "bounce" in water levels actually alter or disturb a wetland's ecology? The major influence is that individual wetland plant species are generally adapted to a fairly narrow and stable range of water depths or soil saturation, and most species favor conditions where water levels rise or fall in a very gradual manner.

When water levels rise frequently, or stay high for extended periods of time, many plant species are stressed. The bounce effect is particularly acute during the early part of the growing season when the shoots and stems are still short, and the plants are fully inundated. Several invasive or aggressive wetland species, such as reed canary grass and cattail, thrive or at least tolerate the bounce effect, and tend to crowd out more sensitive species.

*Water Quality*

A large number of grab samples were taken from the largest open water pool in the study wetlands (or near the outlet if there was no open water) to characterize water quality conditions. As shown in Table 2, wetland water quality tended to decline slightly when contributing watersheds urbanized. Non-urbanized wetlands in the Pacific Northwest tend to be slightly acidic, but tended to become more neutral as watershed development increased.

Conductivity and nutrient levels also increased noticeably as upstream watersheds urbanized. The same pattern was also observed for zinc and fecal coliform levels. In most cases, the decline in water quality was relatively modest, particularly when these values are compared to typical stormwater runoff or stormwater pond concentrations. The decline in water quality, however, may be a significant factor for certain wetland types, such as bogs and fens, that are highly sensitive to changes in nutrient inputs and increases in pH levels.

#### Wetland Soils

Multiple sediment samples were collected in the study wetlands to evaluate how their sediment characteristics responded to upstream development. Perhaps the most noticeable difference was an increase in pH in the sediments of bog wetland types. In general, there was a strong tendency for redox to rise in the wetland sediments. Trends in nutrient, organic content and metals levels in wetland sediments were more ambiguous, leading the study team to conclude that, except for the modest increase in pH, there were no obvious signs

that the quality of wetland sediments had declined in response to recent watershed development.

#### Impacts of Urbanization on Palustrine Wetland Flora and Fauna

One of the hallmarks of the study was the long term investigation of how various flora and fauna responded to changes in urban wetlands over an eight-year time span. And indeed, the effect of watershed factors on the wetland flora was a major focus of the study. Some of the key findings are highlighted in Table 3.

The richness or number of plant species was used as an index of wetland diversity. Some 242 plant species were recorded in all of the wetlands studied, but the number of species found in any individual wetland ranged from 35 to 109. The number of species found was not related to the area of the wetland. Instead, the richer plant communities were associated with more complex hydrology and surface topography, which provided more surfaces at different gradients for individual plant species to exploit. More uniform wetlands with simple hydrological patterns had fewer wetland community types, and consequently, fewer species.



**Table 3: Influence of Urbanization on Flora and Fauna of Wetland Communities**

Wetland Community	Key Findings from the Wetland Study
<b>Wetland Plants</b>	Plant richness was negatively correlated with increasing watershed impervious cover and water level fluctuation (WLF) for emergent and scrub-shrub wetlands (but not forested wetlands). Impact of WLF was greatest when it occurred early in the growing season. Particular losses noted for thin-stemmed species. 62% of urbanizing wetlands lost plant species. Plant richness dropped sharply when water depths were greater than two feet. Plant richness not correlated with wetland area. Several invasive or aggressive plant species were favored when WLF was high (e.g., reed canary grass).
<b>Amphibians</b>	Species richness was inversely related to watershed impervious cover and mean water level fluctuation.
<b>Mammals</b>	Mammal richness was highly variable among and within study wetlands. Mammal richness was most strongly related to the width and complexity of adjacent forest land to the wetland. The presence of large woody debris in the forest land was important. Wetland area and wetland type were not strongly correlated with mammal richness.
<b>Birds</b>	No detectable change in overall bird richness as impervious cover increased. "Adapter" species flourished, some "avoider" species declined. Most resident bird species maintained their populations over the study. Richness in bird community more related to complexity of wetland habitat types within an individual wetland.
<b>Macro-invertebrates</b>	Some trend toward decreasing taxa richness with more impervious cover. Shredder and scraper functional species declined as well as odontates.

R0079652

**Table 4: Excerpts from Puget Sound Wetland and Stormwater Guidelines  
(Azous and Homer, 1997)**

Provide an extensive vegetated buffer around palustrine wetlands.

Measure existing wetland hydroperiods and estimate future hydroperiods as a result of future development. Based on this analysis, seek to restrict:

- Mean monthly water level fluctuation (WLF) of less than eight inches
- More than six excursions above six inches in the wetland an average year
- Duration of these excursions should not exceed three days in the wetland
- Total dry period in the wetland should not change by more than two weeks

More stringent criteria were set to protect bogs and fens. In these systems, WLF should not exceed 24 hours in duration and upstream nutrient controls are required.

Specific land use and stormwater management requirements are then evaluated to meet the WLF criteria.

4

Plant richness strongly correlated with both WLF and impervious cover. In general, the greater the WLF, the lower the richness of plants found in a wetland. The effect was greatest when a high water level fluctuation corresponded with the early growing season (February 1 to March 31). It was also noted that an increase in WLF from one year to the next saw a decrease in species richness and an increase in exotic invasive species in the succeeding years. The effect of WLF on plant richness was not observed for forested wetlands, but it is possible that several decades of study would be needed to detect any change in such a long-lived community.

Perhaps the greatest effect of watershed factors was observed for amphibians. While the amphibian fauna in the Pacific Northwest is not as rich as elsewhere in the country, up to seven species of salamanders, frogs, toads and newts are frequently found in undisturbed palustrine wetlands. Richter and Azous (1997), however, found that amphibian communities were less rich in wetlands located in urbanizing watersheds. Species richness was negatively correlated with watershed impervious cover, and in particular, with higher WLF.

Richter and Azous had previously discovered that most amphibians have very specialized breeding requirements, and tend to attach their egg masses to thin-stemmed emergent or submergent wetland plants. The direct effect of a high WLF is the stranding of egg masses: water levels are temporarily high when the egg masses are attached, and when they subsequently drop, the egg masses are stranded, leading to desiccation. The indirect effect of a high WLF is a gradual loss of the thin-stemmed species upon which amphibians depend, and eventual replacement with broader-stemmed species (such as the cattail).

The response of birds, mammals, and macro-invertebrate communities to watershed and wetland changes was less clear (Table 3). In the Puget Sound region, over 80% of bird species have been observed to use wetlands. No obvious trends in the richness of bird species were detected, and most resident bird species maintained their populations over the eight years. "Adapter" species that thrive in urban watersheds (crows, mallards, starlings, sparrows) tended to increase in population, whereas rarer residents (known as "avoiders") declined. Two factors were found to explain much of the pattern of bird richness: the number of wetland community types present in an individual wetland, and the presence of large forest areas close to the wetland. Impervious cover was not strongly correlated with bird richness.

Much the same response was seen for the mammal community. Nineteen native mammal species were observed in the 19 study wetlands, although only one to 13 were captured in any individual wetland. The mammal population was quite variable between and within individual sites. Watershed and wetland factors did not explain the distribution of mammal richness. Instead, this was tied to the width and structural complexity of the forest lands adjacent to the wetland, as well as the presence of large woody debris on the forest floor. Mammal richness appeared to be linked more to the quality of a wetland's forest buffer, than the complexity of wetland habitat itself.

#### *Strategies to Protect Palustrine Wetlands from Watershed Development*

The Puget Sound wetland study has several important implications for watershed managers. Taken together, its results provide a more scientific basis for designing watershed strategies to protect natural wetlands. Indeed, the study team concluded that palustrine wetlands could not be protected by simply regulating



development activity within wetland boundaries. Instead, managers must evaluate the changes in land use in upstream watersheds, and predict how this will influence the hydroperiod of a wetland. Other key elements of a watershed approach to protecting wetlands include retaining forest cover, minimizing impervious cover, and maintaining natural storage reservoirs, drainage corridors and forested buffers.

The study team developed a set of management guidelines to protect palustrine wetlands from upstream development (Azous and Horner, 1997). Excerpts from the guidelines can be found in Table 4. In general, they require that an analysis of current and future wetland hydrology be conducted to determine the magnitude, duration and frequency of changes to water level fluctuations in individual palustrine wetlands. This usually entails application of a continuous hydrologic simulation model for the watershed and wetland. The results of this analysis are compared to a set of four target criteria for most wetland types, which were derived from the wetland study (Table 4). Special criteria were developed for bogs and fens, given their sensitivity to changes in hydrology, pH and nutrient inputs.

Many of the protection guidelines are now being incorporated into local watershed and master drainage plans. A prominent example is the East Lake Sammamish Basin Plan, developed by the King County (Washington) Surface Water Management Division. This basin has faced rapid development since 1980, and is being transformed from forest and rural residential land uses to higher density residential and commercial land uses. This growth pressure has raised concerns about the threat to the 40 wetlands within the basin. Continuous simulation models were used to forecast WLF in watersheds that are experiencing rapid growth. Special small watershed plans were developed to protect nine wetlands that were designated as unique and outstanding. Major components of the wetland protection plans included the following:

- Capping total impervious area in the watersheds to 8%, where allowed by zoning
- Requiring that 50% of the existing forest cover be retained in some watersheds
- Encouraging development to be clustered away from hydrologic source areas
- Requiring construction of infiltration basins to decrease runoff volumes in one watershed
- Seasonal clearing limits for construction activities that prevent any clearing and grading during the wet season (October through April)

While the specific numerical targets for WLF developed in the Puget Sound ecoregion are probably not transferable to other regions of the country, the broader management concepts are a good starting point for managing

stormwater wetlands at the watershed level.

#### *Conditions for Using Natural Wetlands for Stormwater Treatment*

The study team developed guidance for a rather narrow set of conditions under which natural wetlands might be used for stormwater treatment. Potential treatment candidates must satisfy three broad criteria. First, the candidate wetland must already be highly altered by watershed development, and meet certain benchmarks for isolation, high WLF, low wetland plant richness, dominance of invasive or aggressive plants and altered hydrology. Second, it must be shown that the wetland site does not contain any unique wetland features (not a peat, forested or priority wetland, no rare or endangered species, no salmon rearing habitat, among other factors).

Lastly, any proposed modification must be designed to restore or enhance the existing wetland. Construction should disturb as little of the wetland as possible, and any stormwater storage provided should not greatly increase surface water elevations or cause permanent inundation. For a complete list of the criteria, please see Appendix A in Azous and Horner (1997).

#### *Implications for the Designer of Stormwater Wetlands*

This study also has some implications for engineers that are designing stormwater wetlands located outside of natural wetlands. Specifically, it helps set up some expectations about the level of plant and animal diversity that might be achieved in these systems. Stormwater wetlands, and particularly those that employ extended detention, can expect to have a mean WLF of several feet, and WLF durations that extend for several days. Consequently, wetland plant and animal richness within these constructed systems will probably always be much lower than their natural counterparts. The only technique that designers have to compensate for the ubiquitous WLF of stormwater wetlands is to create complex internal topography that creates a range of depth zones to be exploited.

#### **Summary**

The Puget Sound wetland study has produced a much greater understanding of how palustrine wetlands are linked to their watersheds, and how these watershed factors can influence them. The sobering news for watershed managers and wetland regulators is that a relatively small amount of watershed urbanization (>4%) can produce detectable changes in wetland quality, with more severe changes in wetland quality occurring when total impervious cover exceeds 20%. This trend is similar to the strong relationship between impervious cover and stream quality that was previously discovered in the same ecoregion by May *et al.* (1997). It provides yet another example of the fact that

R0079654

individual water resources cannot be effectively protected without managing land use in the watersheds in which they exist. —TRS

#### References

Azous, A. and R. Horner. 1997. *Wetlands and Urbanization: Implications for the Future. Final Report of the Puget Sound Wetlands and Stormwater Management Research Program*. Washington State Department of Ecology, Olympia, WA. King County Water and Land Resources Division and the University of Washington, Seattle, WA.

Cooke, S. and A. Azous. 1993. *Effects of Urban Stormwater Runoff and Urbanization on Palustrine Wetland Vegetation: A Report to the U.S. Environmental Protection Agency, Region 10*. Puget Sound Wetlands and Stormwater Management Research Program. Center for Urban Water Resources Management. University of Washington. Seattle, Washington.

Chin, N. 1996. *Watershed Urbanization Effects on Palustrine Wetlands: A Study of the Hydrologic, Vegetative, and Amphibian Community Response Over Eight Years*. Master of Science in Civil Engineering Thesis. University of Washington. Seattle, WA.

May, C., R. Horner, J. Karr, B. Mar, and E. Welch. 1997. "Effects of Urbanization on Small Streams in the Puget Sound Lowland Ecoregion." *Watershed Protection Techniques* 2(4): 483-494.

Richter, K. and A. Azous. 1997. "Amphibian Distribution, Abundance and Habitat Use." 1997. *In Wetlands and Urbanization: Implications for the Future. Final Report of the Puget Sound Wetlands and Stormwater Management Research Program*. A. Azous and R. Horner, editors. Washington State Department of Ecology, Olympia, WA. King County Water and Land Resources Division and the University of Washington, Seattle, WA.

# Loss of White Cedar in New Jersey Pinelands Linked to Stormwater Runoff

One of the impacts of suburban stormwater runoff in the New Jersey Pinelands is the conversion of classic Atlantic white cedar wetlands to swamps dominated by hardwoods. Researchers Ehrenfeld and Schneider (1990, 1991) documented the link between human disturbances and vegetative changes at a series of wetland sites defined by differing levels of suburban intrusion. Importantly, they found that cedar wetlands directly influenced by stormwater runoff were much more strongly altered than all other wetland sites.

The cedar swamp is a unique habitat and serves as home to many rare and endangered plants and animals. In New Jersey and other states in the mid-Atlantic region, this habitat is typified by a nearly monospecific canopy of Atlantic white cedar with perhaps small amounts of several deciduous species including red maple, black gum, and sweetbay magnolia. The understory usually contains a variety of shrub species and the undulating swamp floor is carpeted with *Sphagnum*. The cedar swamp is a stressful environment, combining extreme acidity with low nutrient availability. The conditions result in a sensitive plant community with low diversity structure.

Virtually all water entering these wetlands is derived from infiltration in the uplands. This tight hydraulic connection assures that upland development will impact the quantity and quality of the water. Constituents of concern include nutrients, chloride, heavy metals, and organic chemicals from sources such as septic systems, lawns, and road surfaces. In addition, imper-

vious surfaces reduce groundwater recharge and influence the seasonal dynamics of the water table. Drainage ditches, and stream channelization also can act to change wetland hydrology.

Ehrenfeld and Schneider defined four groups of sites within the Pinelands to represent a gradient of suburban impact:

- *Control sites* were located within undisturbed watersheds and completely isolated from engineering features associated with development.
- *Near sites* were proximate to, and upstream of, unpaved roads within undisturbed watersheds.
- *Developed sites* were located within suburban developments with septic systems present along the wetland edge.
- *Runoff sites* were located in developed areas, and had stormwater sewer outfalls directly to the wetland.

Each individual site chosen for the study (four to five sites within each group) had a closed canopy of white cedar and was sampled for hydrologic, water quality, species composition, and community structure. Table 1 presents water quality data from each of the groups.

Species composition in cedar wetlands is highly sensitive to development. As part of the study, the researchers classified all species observed into four habitat categories: *indigenous* to cedar swamps; found in other *Pineland* habitats; found in non-Pineland



**Table 1: Mean Water Quality Parameters Measured During the Growing Season at the Four Site Types - Sample Sizes in Parentheses (Ehrenfeld and Schneider, 1991)**

Parameter	Control	Near	Developed	Runoff
<b>Ammonia (µg/l)</b>				
Surface water	3.9 (38)	2.2 (46)	141.3 (18)	229.4 (54)
Ground water	42.1 (50)	98.4 (50)	506.2 (48)	583.3 (60)
<b>Orthophosphate (µg/l)</b>				
Surface water	14.4 (64)	12.5 (88)	7.6 (24)	55.0 (92)
Ground water	11.0 (80)	12.7 (100)	30.9 (72)	68.0 (98)
<b>Chloride (mg/l)</b>				
Surface water	4.71 (40)	6.25 (46)	6.93 (18)	12.99 (54)
Ground water	4.93 (50)	7.04 (50)	16.4 (50)	15.4 (60)

**Figure 1: Percentage of Plant Species From Different Habitats Within Each Site Type (Ehrenfeld and Schneider, 1991)**

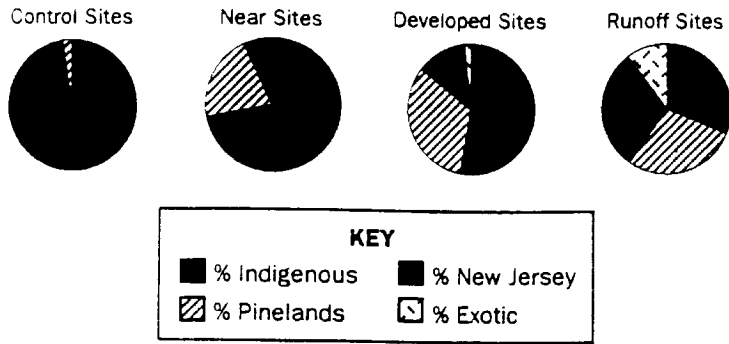

4

habitats in *New Jersey*; and *exotic* to the state. As shown in Figure 1, the control sites were highly dominated by species indigenous to cedar swamps. However, as development intensity increased, indigenous species were dramatically displaced by species not traditionally associated with cedar swamps. Thus, cedar swamps impacted by development gradually lost species that define their uniqueness.

Reproduction of white cedar itself proved especially sensitive to development stress. Cedar stands in the Pinelands are typically even-aged, reflecting establishment after a large-scale disturbance such as fire, extensive windthrow, or clearcutting. As seen in Figure 2, mean densities of white cedar seedlings were greatly reduced in the developed and runoff sites. The implication is that when the next large-scale disturbance occurs, the current stands will not be replaced by new cedar growth.

This decline in cedar seedlings may be directly related to the decline in *Sphagnum* in these sites.

*Sphagnum* is the most common substrate on which cedar reproduction is generally found and holds a large reservoir of buried viable seed. Unfortunately, the plant is especially sensitive to chloride, trampling, hydrological changes, elevated nitrogen concentrations, and other consequences of suburban development. Thus, the loss of the carpet of *Sphagnum* in a cedar swamp may foreshadow the eventual loss of the cedar trees themselves when a large-scale disturbance decimates the stand. The decline of *Sphagnum* cover as a result of increasing runoff is shown in Figure 3.

In summary, the study shows that protecting the integrity of white cedar wetlands requires careful planning to reduce suburban influences. Runoff must be diverted away from the cedar swamp and a buffer area maintained. The health of the *Sphagnum* in a particular swamp can potentially be used as an indicator of the future viability of white cedar wetlands.

—JS

### References

- Ehrenfeld, J.G. and J.P. Schneider. 1990. "The Response of Atlantic White Cedar Wetlands to Varying Levels of Disturbance from Suburban Development in the New Jersey Pinelands." *Wetland Ecology and Management: Case Studies* 63-77. (Ed. by D.F. Whigham, R.E. Good and J. Kvet). Junk, Dordrecht.
- Ehrenfeld, J.G. and J.P. Schneider. 1991. "*Chamaecyparis thyoides* Wetlands and Suburbanization: Effects on Hydrology, Water Quality and Plant Community Composition." *J. Applied Ecology*. 28:467-490.

**Figure 2: Mean Densities of White Cedar Seedlings per Square Meter for Each Site Type (Ehrenfeld and Schneider, 1991)**

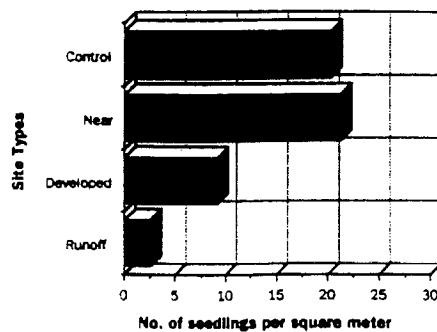

**Figure 3: Mean Percent Cover of Sphagnum for Each Site Type (Ehrenfeld and Schneider, 1991)**

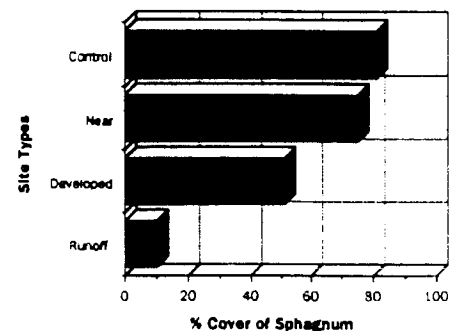

# Wetter Is Not Always Better: Flood Tolerance of Woody Species

**T**here is debate on the contribution of impervious cover to flood frequency and severity and the degree to which natural wetlands and riparian environments are affected. A related and controversial issue is whether natural wetlands should purposely be used to intercept stormwater runoff. Results of studies on the flood tolerance of herbaceous and woody plants would help in resolving this issue. Drawing on the separate literatures of flood tolerance and wastewater loading, Niering (1990) summarizes the multiple effects of submergence and pollutants on woody and herbaceous species of the Northeast US. The information can be used in assessing the impact of increased impervious cover on natural plant communities or in the design of vegetative buffers for intercepting stormwater runoff.

Studies of flood tolerance are also helpful for designers of constructed wetlands (either for water treatment or loss mitigation) in deciding whether and what woody species can be successfully established. Good choices cannot be made based simply on stereotypical examples of flood tolerant species, such as alder. "Obligate" wetland species do not necessarily have superior flood tolerance. To further complicate the decision, different ecotypes of a single species can respond very differently to flooding (Tiner, 1991 in McIninch *et al.*, 1994). Furthermore, "wet acclimation" of nursery trees and shrubs before planting does not really improve their chance of survival (McIninch *et al.*, 1994).

### *Multiple Aspects of Flooding*

An increase in paved surfaces and greater channelization of streams increases the rate and volume of runoff delivered to streams, thus altering the hydroperiod of wetlands and riparian environments. Groundwater recharge is affected and, typically, the frequency, duration, and depth of flooding in wetlands is increased to some degree. An excess of water—even unpolluted water—is deleterious to plant health and growth as it results in higher or sustained water levels in wetlands and increased soil saturation in upland zones. The severity of these effects depends on the species of plant and on various aspects of the flood: season, degree of soil saturation, flow, rainfall, water temperature, and most especially *frequency, duration, and water depth*.

### *Flood Sensitivity of Wetland Plants*

In riparian environments, flooding can cause the death of trees. The seedlings of trees are more vulnerable than adults and all are more vulnerable in the growing season. In bogs, floating mats of vegetation survive but the surrounding trees may die. Increased frequency of flooding can lower species diversity by eliminating the herbaceous species. An increase in duration of flooding results in leaf drop, chlorosis, and decreased growth—all not necessarily fatal.

An increase in water depth is significant if the root collar of a tree is covered, inhibiting respiration. This is more significant an impact to the tree than is saturation of the soil and is the reason for seedling sensitivity to flooding. Adults, seedlings, and seeds have different requirements. For example, adult cypress trees are very flood-tolerant; however, periodic fluctuations in water level in needed for the fruit to dry and germinate.

In examining these effects, Niering (1990) uses the forested swamps of New England as an example wetland. Different studies have made apparently contradictory observations on the survival of different woody species. The flood tolerance of species such as red maple, black gum, ash, alder, and buttonbush varies greatly depending on, among other factors, the age of



**Table 1: Survival of Adult Trees in Flooded Wetlands of New England (Whitlow and Harris, 1979)**

Flood-tolerant	Moderately tolerant	Intolerant
Black alder	American elm	American beech
Black willow	Basswood	Black cherry
Red maple	Bigtooth aspen	Chinquapin oak
Silver maple	Hop hornbeam	Eastern hemlock
	Ironwood	Paper birch
	Red oak	Quaking aspen
	White ash	Red spruce
		Sugar maple
		White birch
		White oak
		White pine
		Yellow birch

Flood-Tolerant: Survive season-long deep flooding  
 Moderately Tolerant: Survive flooding/saturated soil for 30 days in growing season  
 Intolerant: High mortality if flooded in growing season for more than a few days

**Table 2: Seedling Survival of Container-Grown Woody Species in Flooded and Non-Flooded Conditions (McIninch et al., 1994)**

Species, Natural range	1st Season: "acclimation"	2nd Season: seasonal or permanent flooding
<b>Red maple</b> All of Eastern US to E. Texas, SE Canada	Good survival in unflooded pots or saturation -5" but few survive (30%) in 10" saturation	Poor survival (50%) when saturated deeper than 2" seasonally; no seedlings survived permanent flooding
<b>Common alder</b> E. Canada, US; S. to FL; W. to TX	Poor survival when saturated 5"; very poor survival when satu- rated 10"	Moderate to poor survival (around 60%) in seasonal or permanent flooding
<b>Red chokeberry</b> E. Canada, US; S. to FL; W. to KY	Does well in unsaturated or 2"- saturated soil; but 50% survive 5" saturation, none survive 10"	Very poor survival (20-40%) in seasonal flooding. (Permanent flooding not tested)
<b>Buttonbush</b> * E. Canada, US, W. to MN, S. to Mexico	Good survival at all saturation depths	Good survival at all saturation depths, seasonal or permanent
<b>Atlantic white cedar</b> E/ SE US coast	Good survival at 5" saturation or less	Very poor survival (0-20%) in 2nd year
<b>Green ash</b> * All Eastern US, W to Dakotas, SE Canada, SW to Rockies	100% survival at all saturation depths	Excellent survival (80-100%) at all saturation depths.
<b>Winterberry</b> E. Canada, S. to MD, W. to MI	Poor survival at 5" saturation	None survived second season in flooded conditions
<b>Sweet bay magnolia</b> * Mid-SE US	100% survival at all saturation depths	Very good survival (80-100%) in seasonal or perm. flooding
<b>Swamp tupelo</b> * SE US, (N of Florida)	Excellent survival in all satura- tion depths	Good but somewhat inconsis- tent survival in 2nd year
<b>Bald cypress</b> * SE lowland US	100% survival in all saturation depths	100% survival of seedlings in all saturation depths (but dry periods are needed for seed germination)

\* = Good planting choice

the plants and the duration and depth of flooding (Table 1). Seedlings and saplings are most vulnerable; floods of short duration are not as damaging as prolonged saturation of the soil.

McIninch et al. (1994) and McIninch and Biggs (1993) tested 10 woody species common to wetlands in different hydric regimes and found that all the species survive in mesic or two-inch saturated soils—the big differences in survival occur when the soil saturation is five inches or more (Table 2). This seems to be the dividing line between plants that grow in wet soils and plants that are truly flood tolerant. Tolerant species

show changes in their structure (e.g., stem swelling, growth of lateral roots) in response to prolonged saturation (McIninch and Biggs, 1993).

#### *Changes in Community Composition*

In general, an increase in frequency, duration, and depth of floods in forested swamps suppresses herbaceous growth—diminishing species richness of the understory. However, a disturbance such as flooding or pollution often favors certain species over others. Opportunistic, flood- or pollutant-tolerant species such as cattails out compete other herbaceous species. The

planting of such pollutant-tolerant species is a good idea if you're a water quality manager but a worry if you're an ecologist charged with monitoring the spread of invasive species. Low-nutrient bogs are especially susceptible to species replacements when exposed to nutrients from stormwater runoff.

Niering concludes that because of the significant ecological impacts of flooding, existing natural wetlands should not be used for treating stormwater runoff—the quality and quantity of which is unpredictable. Other filtering systems can be used to intercept runoff before it reaches wetlands. Natural landscaping and natural buffer zones are also recommended.

McIninch found containerized stocks of bald cypress, buttonbush, green ash, swamp tupelo, and sweet bay magnolia to be good choices for plantings, whereas Atlantic white cedar, red maple and common alder were not. Wet acclimation did not improve the survival of "flood-tolerant" species and killed a good percentage of the "poor" species (Table 2).

There are two main points to draw from these kinds of studies:

- Shrubs and trees common to wetlands cannot automatically be assumed to have good flood tolerance in urban or altered wetlands, and
- The practice of growing seedlings in flooded containers before planting should be discontinued as it does not appear to have any real acclimating value.

—JMC

## References

- Niering, W. A. 1990 *Effects of Stormwater Runoff on Wetland Vegetation*. Review Paper Presented at New England Institute of Environmental Studies Conference at Southborough MA October 1989.
- McIninch, S. M., and D. R. Biggs. 1993. "Mechanisms of Tolerance to Saturation of Selected Woody Plants." *Wetland J.* 5(2): 25-27.
- McIninch, S., E. Garbisch, and D. Biggs. 1994. "The Benefits of Wet-Acclimating Woody Wetland Plant Species." *Wetland J.* 6(2): 19-23.
- Whitlow, T. H., and R. W. Harris. 1979. *Flood Tolerance in Plants: A State-of-the-Art Review*. US Army Corps of Engineers, Waterways Expt. Stn., Vicksburg, MI. Technical Report E-79-2. 257 pp.

R0079660

# The Compaction of Urban Soils

4

Many professionals have an interest in the compaction of urban soils. For example, a structural engineer may need to increase compaction to provide a stable foundation for a road or building. Conversely, an urban forester or landscaper may want to decrease or prevent compaction in order to improve root growth and plant survival. A stormwater engineer must understand soil compaction to accurately model the runoff from lawns and landscaped areas, to identify suitable locations for stormwater treatment practices, or to stabilize an embankment or slope. Soil compaction is also an important issue for managers involved in land conservation, erosion and sediment control, watershed education and watershed planning. In this article, we examine how soil compaction increases in response to watershed development and the implications it has for watershed professionals.

What distinguishes soil from dirt? One of the major factors is the amount of "fluff" within a soil. Undisturbed soils have a lot of pore space. Indeed, air comprises from 40 to 55% of the soil volume (unless it has recently rained, in which case the pore spaces are filled

up with water). Scientists and engineers frequently measure bulk density to indicate how much fluff is present in a particular soil. Bulk density is defined as the mass of dry soil divided by its volume, and is expressed in units of grams per cubic centimeter (gms/cc). Bulk density is a useful indicator of the structure of a soil, and can help predict its porosity, permeability, infiltration rate and water holding capacity. In general, as the bulk density of a given soil increases, it will produce more surface runoff and allow less infiltration.

The surface bulk density of most undisturbed soils ranges from 1.1 to 1.4 gms/cc, depending on the type of soil present (Table 1). Soils that are predominately sands or clays are on the lower end of the range, whereas silts and silt loams are on the high end of the range. Glacial tills, which were compressed by thousands of feet of ice in the last ice age, can have a bulk density ranging as high as 1.6 to 2.0 gms/cc, depending on how much they have weathered. Highly organic soils, like peat, can be as low as 0.3 gms/cc. In general, bulk density increases with soil depth, reflecting the compression by the overlying soil, and the decline in the abundance of soil fauna and organic matter.

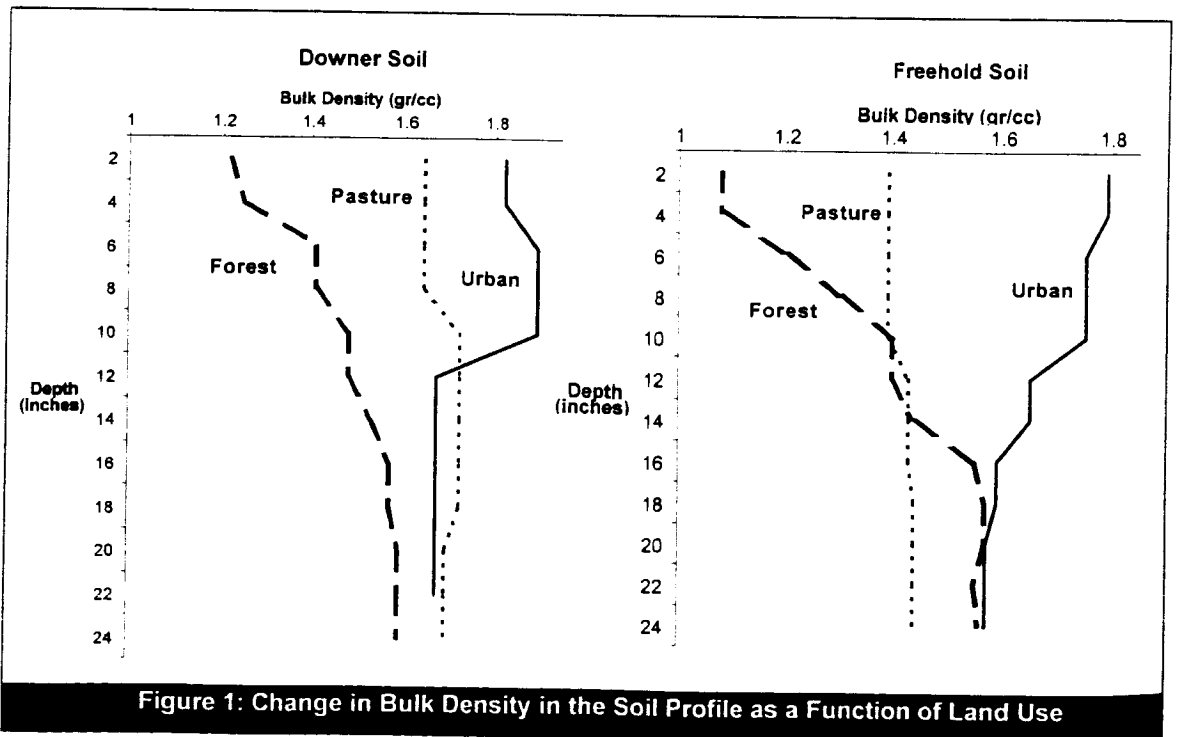

Figure 1: Change in Bulk Density in the Soil Profile as a Function of Land Use



Figure 1 shows a typical profile of how bulk density changes with depth for soils of different land use (Smith, 1999).

In contrast, many urban soils and surfaces have much higher bulk densities (Table 1). The highly disturbed soils of urban lawns range from 1.5 to 1.9 gms/cc, while athletic fields and fill soil typically range from 1.8 to 2.0 gms/cc. These bulk density values approach the density of concrete (2.2 gms/cc). Soils adjacent to building pads and along the road rights of way are intentionally compacted to meet engineering specifications, and can range from 1.5 to 2.1 gms/cc, depending on local compaction standards and the compressibility of the underlying soil.

#### The Consequences of Compaction

The extensive compaction of urban soils has many adverse hydrologic impacts on a watershed. The primary impact relates to the change of porosity within a soil. Figure 2 illustrates how soil porosity diminishes as bulk density increases. Porosity is important because it governs the soil's capacity to hold water, infiltrate runoff and allow roots to penetrate. As porosity declines, compacted urban soils can produce much more surface runoff than is normally expected for grass or meadow cover. While pervious areas are not generally thought to contribute much stormwater runoff, when urban soils become highly compacted, their runoff response more closely resembles that of an impervious surface, particularly during large storm events.

For example, Wignosta *et al.* (1994) found that compacted soils produced from 40 to 60% of the annual runoff for a small developed catchment, and that the soils had an effective runoff coefficient as high as 0.5. Other researchers have also noted that compacted urban soils can have effective runoff coefficients in the 0.2 to 0.45 range (Pitt, 1992, and Legg *et al.*, 1996). While these runoff coefficients are still lower than those commonly reported for completely paved areas (0.50 to 0.99), they are very significant since lawns can comprise as much as 50 to 70% of residential cover. Thus, from a practical standpoint, soil compaction increases watershed runoff and creates drainage problems such as surface ponding, since soils no longer have their water-holding capacity.

The second key concern with soil compaction relates to its impact on the roots of trees, shrubs and ground covers. Generally, once bulk density exceeds 1.6 gms/cc, roots are no longer able to penetrate through the soil, and growth is limited. The critical bulk density for root penetration for different kinds of soils is indicated in Table 2. The practical consequence of the lack of root growth is that trees, shrubs and grass cover are extremely difficult to establish without extensive soil preparation or planting pits. Since compacted soils hold little water, plants are more prone to drought, and may require supplemental irrigation to survive even in humid climates. Likewise,

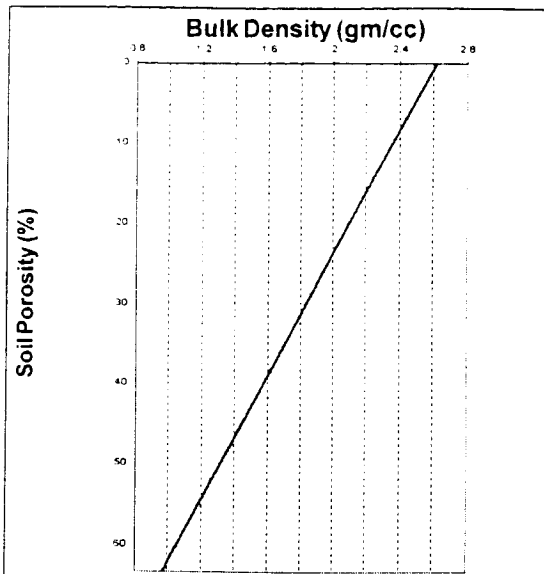

Figure 2: Relationship Between Soil Bulk Density and Soil Porosity

Table 1: Comparison of Bulk Density for Undisturbed Soils and Common Urban Conditions (Compiled from various sources)

Undisturbed Soil Type or Urban Condition	Surface Bulk Density (grams/cubic centimeter)
Peat	0.2 to 0.3
Compost	1.0
Sandy Soil	1.1 to 1.3
Silty Sands	1.4
Silt	1.3 to 1.4
Silt Loams	1.2 to 1.5
Organic Silts/Clays	1.0 to 1.2
Glacial Till	1.6 to 2.0
Urban Lawns	1.5 to 1.9
Crushed Rock Parking Lot	1.5 to 2.0
Urban Fill Soils	1.8 to 2.0
Athletic Fields	1.8 to 2.0
Rights of Way and Building Pads (85% Compaction)	1.5 to 1.8
Rights of Way and Building Pads (95% Compaction)	1.6 to 2.1
Concrete Pavement	2.2
Quartzite (Rock)	2.65

**Table 2: A Comparison of Root Limiting Bulk Density for Different Soil Types (Morris and Lowery, 1988)**

Soil Texture	Critical Root Limiting Bulk Density (grams/cubic centimeter)
Sand *	1.8
Fine Sand *	1.75
Sandy Loam	1.7
Fine Sandy Loam	1.65
Loam	1.55
Silt Loam	1.45
Clay Loam	1.5
Clay	1.4

\* only soil types which do not limit root growth after 85% compaction by proctor test

**Table 3: Comparison of Bulk Density in New Jersey Soils Average Bulk Density in First Foot of Soil (gms/cc) Computed From Database Provided by Smith (1999)**

NRCS Hydrologic Soil Group	No. of Samples	Forest Soils	Pasture Soils	Cultivated Soils
"A" Soils Very low runoff potential	17	1.35 gms/cc	1.48 gms/cc	1.61 gms/cc
"B" Soils Low runoff potential	92	1.30	1.45	1.53
"C" Soils Moderate runoff potential	73	1.27	1.39	1.55
"D" Soils High runoff potential	28	1.20	1.46	1.65

This table provides a comparison of the bulk density for different hydrologic soil groups (HSGs), as classified by the Natural Resources Conservation Service. Hydrologic soil groups are frequently used to define curve numbers to characterize runoff potential within various hydrologic models. The HSG classification is not strictly based on the porosity of the soil, but also includes other soil properties that govern runoff potential, such as the infiltration rate, depth to water table and the presence of confining layers such as hardpans and fragipans. More information on HSG can be found in the National Resources Conservation Service *National Engineering Handbook*, Chapter 2.

Notes: Pasture category includes grassland, hay and grazed lands.

compacted soils have lower oxygen transfer, extreme summer soil temperatures, less nutrient retention, less soil fauna (such as earthworms) and less mycorrhizal fungi compared to uncompacted soils (Bethenfalvay and Linderman, 1992; Craul, 1994). Consequently, urban trees and ground covers tend to be very sparse, short-lived, and disease-prone, unless they are provided with significant irrigation, soil amendments, fertilization and other inputs.

*Bulk Density Increases in Response to Watershed Development*

We do not walk very lightly on the earth. Nearly every kind of watershed development compacts the soil and increases bulk density. Soil compaction begins with grazing, as the weight of livestock tramples soils of the pasture. A modest increase in soil bulk density of 0.12 to 0.20 gms/cc has been observed in pasture soils, compared to forest ones (See Table 3). Soil compaction, however, is largely confined to the surface, and does not extend more than a few inches into the soil profile.

Compaction becomes much more severe when crops are cultivated. As heavy farm machinery passes over the field, soils are compressed up to two feet below the surface. In addition, as topsoil is eroded, more compacted subsoils are exposed. The common practice of tilling the fields does relieve compaction in the upper few inches of the soil profile, but the effect is seasonal and does not extend more than six inches to a foot below the surface. Overall, the effect of cropping is to increase bulk density by an average of 0.25 to 0.35 gms/cc, compared to forest soils, depending on the hydrologic soil group (Table 3).

Compaction becomes even more dramatic during the urbanization of a watershed. Soil structure is compacted in three different ways during the construction process. First, grading equipment works over the site to cut and fill and achieve the desired elevations for building. As a consequence, existing top soil is stripped, stockpiled or even removed from the site, and compacted subsoils are exposed at the surface. Second, as construction equipment and vehicles work the site, their tracks and tires compress the remaining soils several feet below the new surface.

Lastly, certain portions of the site are intentionally compacted with vibrators or rollers to meet soil engineering standards for bearing structures or traffic loads. This intentional compaction usually occurs along the right of ways for roads, a 10-foot envelope around building pads, and around stormwater ponds. Other areas of the site are also frequently compacted as the equipment moves from lot to lot. Local development standards typically require that soils be compacted to within 90 or 95% of their maximum bulk density within these zones.

**Table 4: Reported Land Use or Activities That Increase Soil Bulk Density**

Land Use or Activity	Increase in Bulk Density (gms/cc)	Source:
Grazing	0.12 to 0.20	Smith, 1999 (Table 2)
Crops	0.25 to 0.35	Smith, 1999 (Table 2)
Construction, mass grading	0.34	Randrup, 1998
Construction, mass grading	0.35	Lichter and Lindsey, 1994
Construction, no grading	0.20	Lichter and Lindsey, 1994
Construction traffic	0.17	Lichter and Lindsey, 1994
Construction traffic	0.25 to 0.40	Smith, 1999; Friedman, 1998
Athletic fields	0.38 to 0.54	Smith, 1999
Urban lawn and turf	0.30 to 0.40	Various sources

Taken together, construction increases the bulk density of surface soils on the order of 0.35 gm/cc over the pre-development land use, whether it is forest, pasture or crops (Table 4). The compaction can extend up to two feet down in the soil profile, according to Smith (1999). One of the best studies on the impact of construction on soil compaction was performed by Randrup (1998), who examined 47 Danish construction sites and adjacent undeveloped soils. He reported an average increase in bulk density from 1.60 gms/cc to 1.94 gms/cc, with the greatest compaction found more than a foot below the soil. Lichter and Lindsay (1994) found a similar increase in soil bulk density at several California construction sites. They also noted that bulk density increased by 0.2 gms/cc at a construction site whose soil was neither mass graded nor compacted to meet engineering standards. Clearly, mass grading and the passage of construction equipment are both important factors leading to soil compaction on most construction sites (see Table 4).

According to recent research, soil compaction continues after turf and landscaping are established at the site, at least for the first few years. Bulk density values typically remain about 0.30 to 0.40 gms/cc above pre-development levels after development (Table 4). A few urban areas continue to become more compacted. Most notable are athletic fields, park areas, pathways and unpaved parking lots that continue to experience extensive foot and/or vehicular traffic after development. Surface bulk densities for these compacted soils often range from 1.9 to 2.1 gms/cc, which is almost equivalent to the bulk density for impermeable concrete surfaces.

*Implications of Soil Compaction for the Watershed Manager*

The compaction of urban soils has many implications for the watershed manager. As soil compaction appears to be virtually unavoidable once clearing begins and the

site experiences construction traffic and activity, site planners must physically exclude any construction equipment from portions of the site where undisturbed soils are required or desired. Many stormwater practices utilize the soil to treat or infiltrate stormwater runoff, and are designed under the assumption that the underlying soil is uncompacted and relatively undisturbed (infiltration, filter strips, grass swales, disconnection of rooftop runoff, some forms of bioretention and even septic systems). As a result, these practices should be located outside the limits of construction disturbance. Otherwise, they may require extensive soil amendments to restore their intended function.

The second key implication of compaction relates to the objectives for local erosion and sediment control plans during construction. From a watershed standpoint, these plans should not only focus on preventing soil loss, but go further to prevent soil compaction. Any reduction in clearing, grading and construction access will provide a stormwater management benefit. Uncleared and ungraded portions of the site represent an important "hydrologic reserve area," and erosion and sediment control plans should clearly demarcate the limits of disturbance over as much of the site as possible to retain these. Hydrologic reserves can include wetlands, conservation areas, buffers, setbacks, open space, and even portions of individual lots. However, drawing the limits of disturbance on a plan is much easier than actually enforcing them in the field, so increased contractor training and fencing are essential. Communities should also carefully reevaluate their current compaction requirements and grading standards to ensure that they only compact those areas of the site that are absolutely necessary, and otherwise promote the retention of undisturbed soils.

The third implication of urban soil compaction is that severe soil compaction fundamentally alters the

hydrology of a site, and makes many pervious areas function more like impervious ones. This suggests that engineers will need to explicitly incorporate the effects of soil compaction into their models that predict the changes in runoff as a result of development. The challenge is that while it is relatively easy to predict the increase in bulk density caused by construction, it is much harder to predict precisely how much this increase in bulk density will increase the runoff coefficient or curve numbers for pervious areas. More research is urgently needed to characterize runoff from lawns and landscaped areas on compacted urban soils.

Until better data are available, it seems prudent to model the runoff from pervious areas differently. For example, it may be advisable to adjust runoff coefficients upwards for compacted pervious areas (by approximately 0.1 to 0.15) or, when using the NRCS TR-55 model, to automatically shift curve numbers (CN) upward by at least one hydrological soil group (HSG) when a site is cleared (i.e., if the original pervious area was a B soil, model it as if it were a C soil). An even larger shift is probably justified if the area is planned to be an athletic field or a new lawn.

In summary, watershed managers should bear in mind that the quality of soils is inextricably linked to the quality and quantity of water. Greater efforts to prevent or reduce the compaction of soil quality that results from construction are an important element of any urban watershed protection strategy. —TRS

#### References

- Bethlenfalvay, G. and R. Linderman. 1992. "Mycorrhizae in Sustainable Agriculture." *ASA Special Publication No. 54*. American Society of Agronomy, Madison, WI.
- Craul, P. 1994. "Urban Soils: An Overview and Their Future." pp 115-125 in *The Landscape Below Ground*. Proceedings of International Workshop on Tree Root Development in Urban Soils. International Society of Arboriculture, Champaign, Illinois.
- Friedman, D. 1998. Personal communication. District Director. Ocean County Soil Conservation District. Forked River, N.J.
- Legg, A. R. Bannerman, and J. Panuska. 1996. "Variation in the Relation of Rainfall to Runoff from Residential Lawns in Madison, Wisconsin, July and August, 1995." *U.S. Geological Survey Water Resources Investigation Report 96-4194*. With the Wisconsin Department of Natural Resources, Madison, WI.
- Lichter, J. and P. Lindsay. 1994. "Soil Compaction and Site Construction: Assessment and Case Studies." pp. 126-130 in *The Landscape Below Ground*. Proceedings of International Workshop on Tree Root Development in Urban Soils. International Society of Arboriculture, Champaign, Illinois.
- Morris, L. and R. Lowery. 1988. "Influence of Site Preparations on Soil Conditions Affecting Stand Establishment and Tree Growth." *Southern Journal of Applied Forestry*, 12(3): 170-178.
- Pitt, R. 1992. Small Storm Hydrology. SLAMM Documentation.
- Randrup, T. 1998. "Soil Compaction and Construction Sites." pp. 146-154 in *The Landscape Below Ground II*. Proceedings of International Workshop on Tree Root Development in Urban Soils. International Society of Arboriculture, Champaign, Illinois.
- Schueler, T. 1995. "The Peculiarities of Perviousness." *Watershed Protection Techniques*, 2(1): 233-238.
- Smith, C. 1999. *Soil Compaction Findings and Interpretation*. Natural Resources Conservation Service.
- Wignosta, M., S. Burges, and J. Meena. 1994. "Modeling and Monitoring to Predict Spatial and Temporal Hydrological Characteristics in Small Catchments." *Water Resources Series Technical Report #137*. University of Washington, Dept. of Civil Engineering, Seattle, WA.

R0079665

# Can Urban Soil Compaction Be Reversed?



Soil compaction appears to be an inevitable result of current construction practices (see article 36). The key question is whether it is possible to reverse soil compaction. Numerous soil scientists have evaluated practices that can avoid compaction during construction or reverse it after it occurs (Table 1). These practices include selective grading, special construction equipment, reforestation, mechanical loosening, and the use of soil amendments. This article reviews what is currently known about how well these practices work and evaluates their potential as a stormwater management strategy in urban watersheds. The consensus among soil scientists is that alleviating urban soil compaction is a very hard job. Indeed, Randrup (1998) notes that once a soil is compacted, it is extremely difficult to restore its original structure, particularly if the compaction extends several feet below the surface.

### *Techniques to Avoid Compaction During Construction*

The traditional remedy for soil compaction has been to require contractors to loosen soil by tillage, ripping or other techniques before lawns are established (much as a farmer plows a field). However, Randrup (1998) could find no significant difference in soil bulk density between Danish construction sites that had been loosened and those that had not. Similarly, Pater-

son and Bates (1994) found that tilling resulted in only a minor improvement in compaction in urban soils in Washington, D.C. (see Table 1).

Another common technique for avoiding soil compaction is the practice of selective grading, where only the most critical portions of the site are mass graded, and the remainder of the site is cleared but not graded. Again, neither Randrup (1998) nor Lichter and Lindsay (1994) were able to detect any improvement in soil bulk density in the selectively graded construction sites. These soils still experienced extensive compaction by construction equipment, stockpiling and vehicle traffic. The only soils where compaction was prevented were areas that were fenced to exclude all construction activity.

In the past several decades, specialized equipment has been developed to minimize compaction (e.g., terralifts, and subsoil excavators). Rolf (1994) detected a modest improvement in bulk density (0.05 to 0.15 gm/cc) when this specialized equipment was used at several Swedish construction sites, compared to traditional construction equipment. Even so, the specialized construction equipment still resulted in soil compaction at the site. Based on current research, it appears that the best construction techniques are only capable of preventing about a third of the expected increase in bulk density during construction.

**Table 1: Reported Activities That Restore or Decrease Soil Bulk Density**

Land Use or Activity	Decrease in Bulk Density (gm/cc)	Source:
Tilling of Soil	0.00 to 0.02	Randrup, 1998, Patterson and Bates, 1994
Specialized Soil Loosening	0.05 to 0.15	Rolf, 1998
Selective Grading	0.00	Randrup, 1998 and Lichter and Lindsey, 1994
Soil Amendments	0.17	Patterson and Bates, 1994
Compost Amendment	0.25 to 0.35	Kolsti <i>et al.</i> , 1995
Time	0.20	Legg <i>et al.</i> , 1996
Reforestation	0.25 to 0.35	Article 36

**R0079666**

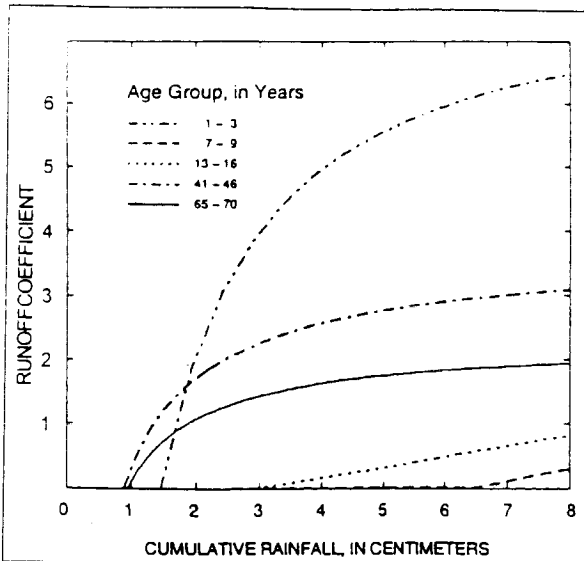

**Figure 1: Cumulative Rainfall Versus Runoff Coefficients for Different Lawn Age Groups**

Further, it is evident that the only truly effective technique for avoiding compaction is prevention, i.e., setting limits of disturbance that are capable of physically excluding all construction traffic from portions of a site.

*Techniques to Reverse Soil Compaction After Construction*

Once soil is compacted, is there anything that can be done to reverse the process? Many natural processes act to loosen up soil, such as freezing/thawing, particle sorting, earth worm activity, root penetration and the gradual buildup of organic matter. Often, however, these processes take decades to work, and operate primarily within the first foot or so of soil. In addition, many of these natural processes are effectively turned off when soil compaction becomes severe (i.e., bulk density greater than 1.7) because water, plant roots and soil fauna simply cannot penetrate the dense soil matrix and get to work.

There is some evidence that the bulk density of residential lawn soils does gradually recover over several decades. Legg *et al.* (1996) monitored the soil and runoff properties of 20 residential lawns in Madison, Wisconsin that ranged in age from one to 70 years. They found that newly established lawns (less than three years old) had the highest bulk density and lowest organic matter content of all the lawns sampled. Subsequent analysis indicated that these younger lawns produced significantly more runoff than their older counterparts (Figure 1). As lawns grew older, bulk density declined modestly and the amount of organic matter increased in the first foot of the soil profile. It was speculated that root penetration, earthworms, and general soil building created more macro pores, and contributed to the improvement in bulk density and soil quality over time.

Another long-term approach for restoring compacted urban soils is reforestation. Trees and shrubs gradually build soil structure through root penetration, leaf fall, macro pores and associated soil fauna. However, this process may take decades to occur, and usually requires a helping hand in urban watersheds. For example, establishing trees in compacted urban soils often requires the excavation of larger and deeper tree pits filled with special soil mixes to allow tree roots to flourish.

*Soil Restoration Through Soil Amendments*

A quicker technique for reducing soil compaction involves amending the soil with organic matter that has a low bulk density, such as compost, fly ash, or peat. Patterson and Bates (1994) found that amendments of sintered fly ash were able to decrease bulk density by 0.17 gms/cc over a 22-year period on soil test plots on the heavily used Mall in Washington, D.C. Other researchers have reported decreases in bulk density of as much as 0.30 gms/cc when compost was incorporated into glacial till soils in the Pacific Northwest (Kolsti *et al.*, 1995). Clearly, the compost amendment technique shows promise in reducing compaction in urban soils, and has recently received a great deal of attention as a potential practice for reducing stormwater runoff problems at the site level. Much of the work in this area has been conducted in the Pacific Northwest, and is focused on incorporating compost amendments for new or existing residential lawns.

The compost amendment practice is fairly simple, and is best started in the very early spring or early fall, during relative dry conditions. For an existing lawn, it begins with a soil test to determine existing bulk density for the yard. If the test indicates that soils are compacted, the next step involves deep tillage of at least the top foot of soil, using a rototiller or ripper. After the sod has had a few months to decompose, compost is incorporated into the soil at the volumetric ratio of one part compost to two parts loose soil (or three to four inches over the lawn). As a rule of thumb, about ten cubic yards of compost are needed per 1,000 square feet of lawn that is amended.

Helpful specifications on determining the proper amount of compost are provided in Chollak and Rosenfeld (1998), as well as guidance on selecting compost of the right source and age. It may also be necessary to add dolomitic lime at a rate 100 lbs/1,000 square feet to control acidity. After compost amendment, grass is then reestablished by seeding or sodding. The process for amending compost into new lawns is slightly different; more detailed information can be found in Chollak and Rosenfeld (1998) and McDonald (1999).

While compost amendment seems like an ideal practice, there are a number of situations where it is not

feasible. These include sites that have steep slopes, a high water table, wet saturated soils, or downhill slope toward the house foundation (these areas are usually poor candidates for a traditional lawn, as well). In addition, deep tillage within three feet of the drip line of trees and shrubs should be avoided.

The cost to install a compost amended lawn on a new residential lawn is about 72 cents per square foot, according to Chollak and Rosenfeld (1998), but can drop to 66 cents per square foot if applied across all the lawns in a new subdivision. For a typical quarter-acre lawn, the cost of installing a compost-amended lawn is about \$7,200, including labor, equipment rental, compost and hydro-seeding. This is about twice the cost of traditional methods to establish a new lawn (Chollak and Rosenfeld, 1998). However, the cost of compost amendment drops to about 20 cents per square foot if labor is excluded (assuming compost is available at \$12/cy, delivered, rental of tiller/spreader, soil test, lime and grass seed). Thus, if a homeowner were to do it himself, the cost of amending an existing quarter acre lawn might run about \$2,200, with the time investment of two or three weekends.

A faster and less costly compost amendment practice has been recently introduced in the Pacific Northwest. It involves aeration of existing soil (but not deep tillage), followed by the placement of about three inches of compost over the surface of the lawn in the fall. The lawn is then seeded in the spring. Initial results indicate that this simplified practice produces good turf, but the hydrologic benefits have yet to be quantified. If future monitoring indicates that this simplified practice works, it will sharply reduce the costs and effort for the individual homeowner to restore his or her yard.

#### *Benefits of Soil Compost Amendments*

A number of recent research studies have explored the potential hydrologic benefits of compost-amended soils. Kolsti *et al.* (1995) monitored test plots of amended and unamended soils over ten storm events in Seattle, and reported that compost-amended soils reduced surface runoff by 29 to 50%, depending on the amount and type of compost used. Even higher reductions in lawn runoff (53 to 74%) were predicted if compost amendments were implemented across a small watershed, according to a model developed by Hieliema (1999). Chollak and Rosenfeld (1998) estimated that stormwater detention basin volumes could be reduced by five to 15% if compost amendments were incorporated into new subdivisions in glacial tills soils near Seattle, Washington.

Compost amendment can also provide benefits for the lawn owner. For example, compost-amended lawns generally have a fraction of the summertime irrigation needs of a normal lawn. In addition, the organic matter in compost supplies meets all of the lawn's fertilization

needs, at least for the first year (Landschoot, 1996). Grass also appears to grow better on compost-amended soils. Indeed, researchers have reported that compost-amended lawns exhibit more rapid turf coverage, denser root networks, greater rooting depths, lower bulk density and higher organic matter (Harrison *et al.*, 1996 and Kolsti *et al.*, 1995).

#### *Compost Amendments as a Stormwater Management Strategy*

The compost amendment practice should be considered an element of better site design, and could be a useful technique to reduce stormwater at the residential lot level. It is likely that its benefits would be amplified in conjunction with lawns also designed to treat rooftop, driveway and sidewalk runoff. Several creative designs to integrate compost amendments with other on-site practices in residential areas are described in Konrad *et al.* (1995). Compost amendments could also be used to improve the performance of grass swales, biofilters and filter strips. Communities may want to encourage developers to install compost amendments during new lawn and landscape construction (possibly through stormwater credits).

Compost amendments might also prove to be an effective tool for watershed restoration, particularly in watersheds where other stormwater retrofit options are not feasible. The cumulative hydrological benefits of restoring soil quality on hundreds of lawns, athletic fields, and vacant lots could potentially be significant. The critical management issue is determining how to deliver lawn and landscape compost amendment services to homeowners in a cost-effective manner across an entire watershed. Communities may need to make free compost and technical assistance available to achieve wider restoration of compacted soils in the urban landscape.

#### **Summary**

While the initial research on compost amended soils is promising, more research and demonstration are needed to more precisely define the stormwater management benefits of the practice. In particular, paired monitoring of the runoff and pollutant load from amended and unamended lawns should be a high priority. Further long term research is also needed to determine how long the benefits of compost amendments persist. For example, are compost amendments only needed once, or must they be repeated as the compost decomposes? What kind of lawn maintenance practices are needed to maintain the benefits of amended lawns? How should the compost amendment practice be adapted to suit conditions in other climatic regions of the country?

Still, perhaps the greatest property of compost amendment is its potential to develop into a true homeowner management practice, particularly if a more sim-



R0079668

plified version can be developed. A homeowner gets the benefit of a better yard, and possibly a better watershed, for simply changing how he or she invests in lawn practices. —TRS

#### References

- Chollak, T. and Rosenfeld, R. 1998. *Guidelines for Landscaping with Compost-amended Soils*. Prepared for City of Redmond Public Works, Redmond, WA. 60 pp. available at <http://depts.washington.edu/cuwrn/>
- Harrison, B, C. Henry, M. Grey and D. Xue. 1996. *Field Test of Compost Amendment to Reduce Nutrient Runoff*. University of Washington. College of Forest Resources.
- Hielema, E. 1999. *Hydrologic Simulation of the Klahanie Catchment, King County, Washington, With and Without a Landscape Consisting of Soil Amended With Compost*. MS thesis. College of Engineering. University of Washington. Seattle, WA
- Kolsti, K, S. Burges, and B. Jensen. 1995. "Hydrologic Response of Residential-scale Lawns on Till Containing Various Amounts of Compost Amendment." *Water Resources Technical Report No. 147*. University of Washington, Dept of Civil Engineering. Seattle, WA.
- Konrad, C., B. Jensen, S. Burges, and L. Reinelt. 1995. *Onsite Residential Stormwater Management Alternatives*. Center for Urban Water Resources Management. University of Washington. Seattle, WA.
- Landschoot, P. 1996. *Using Compost to Improve Turf Performance*. Pennsylvania State University Cooperative Extension. University Park, PA.
- Legg, A. R. Bannerman, and J. Panuska. 1996. "Variation in the Relation of Rainfall to Runoff From Residential Lawns in Madison, Wisconsin, July and August, 1995." *U.S. Geological Survey Water Resources Investigation Report 96-4194*. With the Wisconsin Department of Natural Resources. Madison, WI.
- Lichter, J. and P. Lindsay. 1994. "Soil Compaction and Site Construction: Assessment and Case Studies." pp. 126-130 in *The Landscape Below Ground*. Proceedings of International Workshop on Tree Root Development in Urban Soils. International Society of Arboriculture. Champaign, Illinois.
- McDonald, D. 1999. *Ecologically Sound Lawn Care for the Pacific Northwest: Findings From Scientific Literature and Recommendations From Turf Professionals* (draft). City of Seattle Public Utilities.
- Patterson, J. and C. Bates. 1994. "Long-term, Lightweight Aggregate Performance as Soil Amendments." pp. 149-156. In *The Landscape Below Ground*. Proceedings of International Workshop on Tree Root Development in Urban Soils. International Society of Arboriculture. Champaign, Illinois.
- Randrup, T. 1998. "Soil Compaction and Construction Sites." pp. 146-154 in *The Landscape Below Ground. II*. Proceedings of International Workshop on Tree Root Development in Urban Soils. International Society of Arboriculture. Champaign, Illinois.
- Rolf, K. 1994. "Soil Compaction and Loosening Effects on Soil Physics and Tree Growth." pp. 131-146 in *The Landscape Below Ground*. Proceedings of International Workshop on Tree Root Development in Urban Soils. International Society of Arboriculture. Champaign, Illinois.

R0079669



# Choosing Appropriate Vegetation for Salt-Impacted Roadways

**M**any communities rely on the use of grassed swales or biofilters to filter out pollutants in road runoff. The performance of these vegetative practices along roadsides depends to a great degree on the vigor and density of the floral cover. Two recent studies in Minnesota and Ontario have found that winter use of road salt can exert a significant impact on roadside vegetative communities. Since most locations still rely on road salt as a primary deicing agent, designers need to consider the selection of salt-tolerant roadside vegetation.

In the Minnesota study, Biesboer and Jacobson (1994) studied the role of road salt in limiting germination in six warm season grasses and surveyed roadside soil salt concentrations during a one-year period. Salt levels were measured at prescribed intervals from roadsides. Soil chloride concentrations were highest in the winter (October-May), reaching 22,000 ppm and fell below 2,500 ppm in the summer and early fall after spring rains flushed away accumulated salts. Areas within six feet of busy roads were either largely devoid of vegetation or the originally planted grasses were replaced by undesirable, weedy non-grass species. This pattern was attributed to several factors, including salt accumulation in roadside soils due to winter salting operations.

Biesboer and Jacobson found that salt concentrations were highest within the first three feet from the road and then rapidly declined within 30 feet. They

concluded that most warm and cool season grasses could germinate and grow beyond 10 feet from a road without experiencing salt stress. Planting grasses within 10 feet of a road requires careful selection for salt tolerance. In particular, warm season grasses such as blue grama (*Bouteloua gracilis*) and buffalo grass (*Buchloe dactyloides*) are attractive choices due to their ability to withstand high salinities.

Traditionally, most road designers used cool season grass species along Minnesota roadways. Native warm season grasses, however, have several characteristics making them more attractive options for on-site planting (Table 1). Most importantly, warm season grasses typically germinate in early summer, well after spring rains reduce soil chloride concentrations. Biesboer and Jacobson investigated the salt tolerance of six native warm season grass species, based on their ability to germinate after being surface sterilized and exposed to various salinities (Figure 1). It was discovered that all germination was reduced when seeds were exposed to salt concentrations greater than 2,500 mg/l. Salt concentrations rarely approach this level in early summer, when warm season grasses typically germinate. Consequently, the authors concluded that most of the warm season species could germinate in roadside soils along Minnesota roads. Indeed, some species (blue grama and buffalo grass) exhibited particularly high salinity tolerances.

Two roadside sites were selected in 1993 to field test the survival of warm season grass species. Interestingly, while blue grama was planted, buffalo grass was not among those species included in the field study. Preliminary field data are still being collected and will be useful in evaluating several species' tolerances of road salt.

Germination of wetland plants can also be affected by roadside salt concentrations. Isabelle and his colleagues (1987) demonstrated that roadside snowmelt can alter both the species composition and biomass of wetland vegetation. Snow treated with salt was collected from Ontario roadsites. Scientists then sowed seeds of five wetland plant species in greenhouse plots and exposed them daily to snowmelt/tapwater mixtures containing 0, 20, and 100% snowmelt. Seedlings were harvested one month later.

The study found that the number of germinating seeds was inversely proportional to snowmelt salt

**Table 1: Characteristics of Native Minnesota Grass Species That Make Them Desirable for Roadside Use (Biesboer and Jacobson, 1994)**

- Germination of seedlings or an initial flush of growth from overwintering plants typically occurs in late May-June, after roadside salt accumulations and debris have been flushed from soils by spring rains
- Deep root systems enable them to reduce soil erosion and possibly draw water from the road bed
- Generally short structures may reduce or eliminate the need for mowing.



R0079670

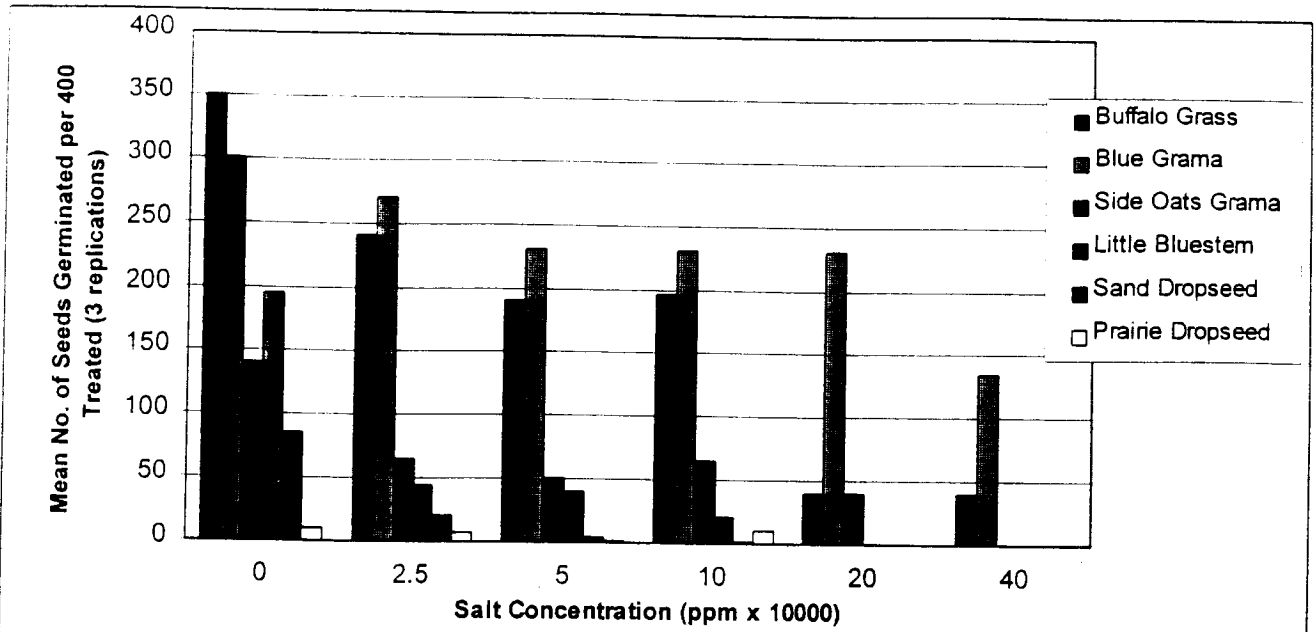

Figure 1: Salt Concentration vs. Germination

concentration and only two undesirable species, purple loosestrife (*Lythrum salicaria*) and common cattail (*Typha latifolia*), germinated when exposed to undiluted snowmelt (Table 2). This finding may explain why these two species often become dominant in urban wetlands in northern states. Overall, it was found that species diversity, evenness, and richness in the greenhouse plots decreased significantly with increased snowmelt concentration. Total biomass also declined. This information underscores the importance of excluding road salt from sensitive environments.

In addition to those evaluated by Biesboer and Jacobson, grass species that may be studied for roadside application in Midwestern areas include: inland saltgrass (*Distichlis stricta*) for alkaline soils that are poorly drained; plains lovegrass (*Eragrostis*

*intermedia*); James' galletta (*Hilaria jamesii*); and alkali sacaton (*Sporobolus airoides*). Other non-grass species should also be evaluated. In a study of plant succession and viability, Wilcox and Andrus (1987) showed that secondary *Sphagnum* succession in a road salt-impacted Indiana bog was dominated by a single species (*S. fimbriatum*) as chloride concentrations surpassed 300 mg/l. The study also illustrated the great sensitivity of *S. fimbriatum* to chloride compared with other salts (Table 3). Although grasses are generally more salt-tolerant than trees, there are several tree species that can withstand relatively high salinities (Table 4). This information may be helpful to practitioners in the selection of deicing agents. For regions outside the Midwest ecoregion, the tolerance of other desirable native species should be investigated.

The studies have important implications for the design of swales, filters and wetlands along roadways. The extensive use of road salt can reduce the biomass, diversity, or density of roadside vegetation communities. Consequently, steps should be taken to protect these resources from the impacts of salt. Plant species able to withstand the physiological stress imposed by road salts should be selected for areas where such stress is expected. Similarly, existing plant communities need to be assessed before adjacent roads are treated by deicing agents. This approach and the plants' natural filtering abilities will help to ensure that impervious area-associated pollutants are kept away from sensitive environments.

—RLO

Table 2: Number of Seeds (Mean and Standard Deviation) of Each Species Germinating When Exposed to Different Snowmelt Concentrations (Isabelle et al., 1987)

Species	Snowmelt concentration (%)		
	0	20	100
<i>Aster umbellatus</i>	5.8 (4.1)	2.0 (5.0)	0
<i>Dulichium arundinaceum</i>	11.6 (2.7)	3.4 (2.3)	0
<i>Scirpus cyperinus</i>	14.2 (4.1)	10.2 (4.5)	0
<i>Typha latifolia</i>	13.2 (4.8)	7.2 (3.9)	1.0 (0.7)
<i>Lythrum salicaria</i>	30.0 (4.6)	19.2 (2.3)	9.0 (5.1)

**Table 3: Changes in Length and Biomass of *Sphagnum fimbriatum* by Type of Salt (Wilcox and Andrus, 1987)**

Salt*	CaSO <sub>4</sub>	Control	Na <sub>2</sub> O <sub>4</sub>	CaCl <sub>2</sub>	NaCl
Mean increase in length (cm)	2.61	2.60	1.90	0.52	0.40
Mean increase in biomass (%)	499.1	337.1	207.3	88.7	42.4

\* Concentrations are equimolar to 1,500 mg/L Cl<sup>-</sup> treatment (42.3 mM Na<sup>+</sup>, 42.3 mM Cl<sup>-</sup>, 21.1 mM Ca<sup>2+</sup>, 21.1 mM SO<sub>4</sub><sup>2-</sup>).

**Table 4: Tree and Shrub Species Which Show High Tolerance to Road Salt (MDOT, 1993)**

Deciduous Plants		Evergreen Plants
Ash, European	Mountain ash, Showy	Adam's Needle
Ash, White	Mulberry, Red	Juniper, Creeping
Aspen, Quaking	Oak, English	Juniper, Eastern Redcedar
Bald cypress	Oak, White	Juniper, Pfitzer
Birch, Gray	Poplar, Bigtooth Aspen	Juniper, Rocky Mountain
Birch, Paper	Poplar, Cottonwood	Pine, Austrian
Buckthorn, Common	Poplar, Lombardy	Pine, Jack
Butternut	Poplar, Quaking Aspen	Spruce, Colorado
Elm, Siberian	Poplar, White or Silver	Spruce, Blue Colorado
Honeylocust, Thornless	Privet	
Honeysuckle	Russian-olive	
Horsechestnut, Common	Staghorn Sumac	
Larch, European	Tree of Heaven	
Lilac, Peking	Walnut, Black	
Locust, Black	Willow, Black	
Maple, Hedge	Willow, Corkscrew	
Maple, Norway	Willow, Pussy	
Maple, Silver		



**References**

Biesboer, D.D. and R. Jacobson. 1994. *Screening and Selection of Salt Tolerance in Native Warm Season Grasses*. Minnesota Department of Transportation. Report 94-11. 33 pp.

Isabelle, P.S., L.J. Fooks, and P.A. Keddy. 1987. "Effects of Roadside Snowmelt on Wetland Vegetation: An Experimental Study." *J. Environ. Mgmt.* 25: 57-60.

Michigan Department of Transportation. 1993. *The Use of Selected Deicing Materials on Michigan Roads: Environmental and Economic Impacts*. Lansing, MI. Prepared by Public Sector Consultants, Inc.

Wilcox, D.A. and R.E. Andrus. 1987. "The Role of *Sphagnum fimbriatum* in Secondary Succession in a Road Salt Impacted Bog." *Can. J. Bot.*, 65: 2270-2275.

R0079672

R0079673

# Section 5: Aquatic Buffers

## Watershed Protection Tool #3

**A**quatic corridors, where land and water meet, always deserve special attention in the practice of watershed protection. A simple buffer along a stream, shoreline, or around a wetland is essential to maintain watershed health. The primary purpose of a buffer is to put some distance between a stream, lake or wetland and any upland development. The second purpose of a buffer is to maintain natural vegetation along the riparian zone, which is an essential part of all aquatic ecosystems. The ability of an aquatic buffer to realize its many benefits depends, to a large degree, on how well it is planned, designed, and maintained. This section contains six articles that describe how communities can adopt effective buffer systems in their watersheds.

Aquatic buffers are perhaps the easiest watershed protection tool to implement at the local level, since they can be created simply by adopting a local ordinance and devoting more resources to plan review. A copy of an annotated model stream buffer ordinance can be easily downloaded from the Center's website ([www.cwp.org](http://www.cwp.org)). The hard part, of course, is convincing elected leaders that the ordinance will not unduly increase the cost of development nor infringe on private property rights. Thankfully, most of the economic and legal evidence (as noted in articles 30, 39 and 49) suggests that a well-crafted buffer program can fully satisfy these rather common objections to stream buffers.

### *Trends in Aquatic Buffers in the Last Decade*

While stream buffers were quite rare a decade ago, they are now relatively common in communities that actively engage in watershed protection. These communities struggled for years to define what the minimum width of a buffer should be, and looked in vain to the scientific community for a specific number. Lacking a precise number, they have generally resorted to a "hundred plus" approach, which extends the buffer at least one hundred feet from each streambank and possibly further, if adjacent wetlands, flood plains, steep slopes or critical habitats are present. In practice, this approach has proved to be reasonably workable, since it minimizes the loss of developable land, while at the same time it maximizes the impressive roster of environmental and economic benefits that a buffer provides.

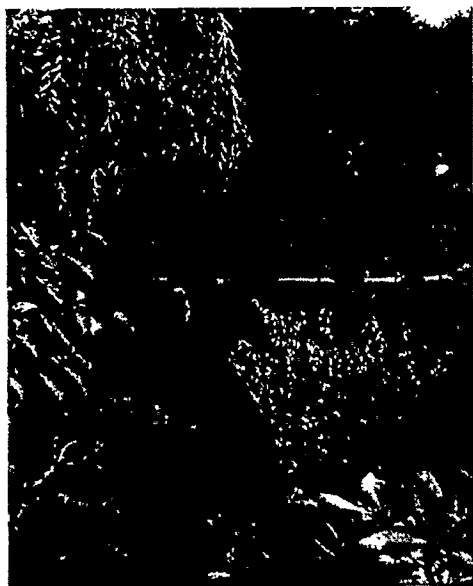

Buffers maintain stream ecology, stabilize stream banks, shade streams, remove pollutants, create wildlife habitats and protect wetlands. Buffers also act as the "right of way" for a stream, allowing them to move around the floodplain, and pass their flood waters safely downstream without damaging property or endangering lives. The land area devoted to stream buffers is roughly equal to the land area that would otherwise be needed for detention ponds that hold back upstream flood waters, and buffers are certainly much cheaper.

Toward the end of the decade, communities started to shift their attention to how stream buffers are managed. Key management issues emerged, such as how to cross the buffer, prevent encroachment, maintain natural vegetation, exclude incompatible uses, manage urban wildlife and effectively integrate stormwater treatment into buffers. Recently, wider use of buffers has been bolstered by early but encouraging research that revealed the valuable role that forest buffers play in maintaining the biological diversity within urban streams, and their potential to shift the impervious cover/stream quality curve upwards.

"Aquatic buffers are perhaps the easiest watershed protection tool to implement at the local level."

While urban stream buffers are not thought to remove pollutants as well as their agricultural counterparts, their capability could probably be vastly improved by "engineering" the outer boundaries of the buffer to more efficiently capture and treat stormwater runoff. In addition, the ability of urban stream buffers to reduce subsurface nutrient loadings from septic systems in more lightly developed watersheds warrants further investigation.

The ability of urban stream buffers to maintain stream biodiversity needs greater confirmation at the watershed scale. In particular, a systematic comparison of biological diversity in streams with and without riparian buffers (yet possessing a similar watershed impervious cover) may prove the best way to demonstrate this effect.

From a management standpoint, it is time to begin studying the condition of stream buffers that we have created over the last decade. Such research could answer some important management questions. For example, have buffers become more fragmented over time? What are the rates of encroachment in their outer boundary? What trends can be seen in buffer forest cover and succession? What is actually happening to stormwater as it crosses the buffer? What kind of wildlife movement is occurring in these corridors? Are deer, beaver or invasive species becoming a problem for the buffer or adjacent residents? The reader could probably come up with other interesting research questions, as well. The key point is that we can only begin to design better stream buffers in the future if we start carefully analyzing the population of stream buffers we have created in the past, and learn from our real world experience.

## **Aquatic Buffers Contents**

39.	The Architecture of Urban Stream Buffers .....	225
40.	Urbanization, Stream Buffers and Stewardship in Maryland .....	234
41.	Invisibility of Stream and Wetland Buffers in the Field .....	239
42.	Techniques for Improving the Survivorship of Riparian Plantings .....	242
43.	Impact of Riparian Forest Cover on Mid-Atlantic Stream Ecosystems .....	243
44.	The Return of the Beaver .....	244

# The Architecture of Urban Stream Buffers

**H**eadwater streams comprise as much as 75% of the total stream and river mileage in the contiguous United States (Leopold *et al.*, 1964). These critical headwater streams are often severely degraded by the urbanization process (Schueler, 1995a). As a consequence, many communities have adopted stream buffer requirements as one element of an overall urban watershed protection strategy. Up to now, buffer requirements have been relatively simplistic—the “design” of a stream buffer often consists of no more than drawing a line of uniform width on a site plan. As Heraty (1993) notes, buffers designed in this manner often become invisible to contractors, property owners, and even local governments. As a result, many stream buffers fail to perform their intended function, and are subject to disturbance and encroachment.

A buffer network acts as the “right-of-way” for a stream and functions as an integral part of the stream ecosystem. Stream buffers add to the quality of the stream and the community in many diverse ways, as summarized in Table 1. In many regions, these benefits are multiplied when the streamside zone is in a forested condition. While the benefits of urban stream buffers are impressive, their capability to remove pollutants borne in urban stormwater should not be overstated. Although communities frequently cite pollutant removal as the key benefit when justifying the establishment of stream buffers in urbanizing areas (Heraty,

1993), their capability to remove pollutants in urban stormwater is fairly limited. This is a surprising conclusion given the moderate to excellent sediment and nutrients removal reported for forested buffers in rural areas (Desbonnet *et al.*, 1994). Much of the pollutant removal observed in rural and agricultural buffers appears to be due to relatively slow transport of pollutants across the buffer in sheetflow or under it in shallow groundwater. In both cases, this relatively slow movement promotes greater removal by soils, roots, and microbes.

Ideal buffer conditions are rarely encountered in urban watersheds. In urban watersheds rainfall is rapidly converted into concentrated flow. Once flow concentrates, it forms a channel that effectively short-circuits a buffer. Unfortunately, stormwater flows quickly concentrate within a short distance in urban areas. It is doubtful, for example, whether sheetflow condition can be maintained over a distance of 150 feet for pervious areas and 75 feet for impervious areas (Figure 1). Consequently, as much as 90% of the surface runoff generated in an urban watershed concentrates before it reaches the buffer, and ultimately crosses it in an open channel or an enclosed stormdrain pipe. As a result, some kind of structural stormwater practice is often needed to remove pollutants from runoff before they enter the stream.



**Figure 1: Watershed Geometry and the Concentration of Flow: The Overland Flow Path to the Stream and the Distance Before Flow Concentrates**

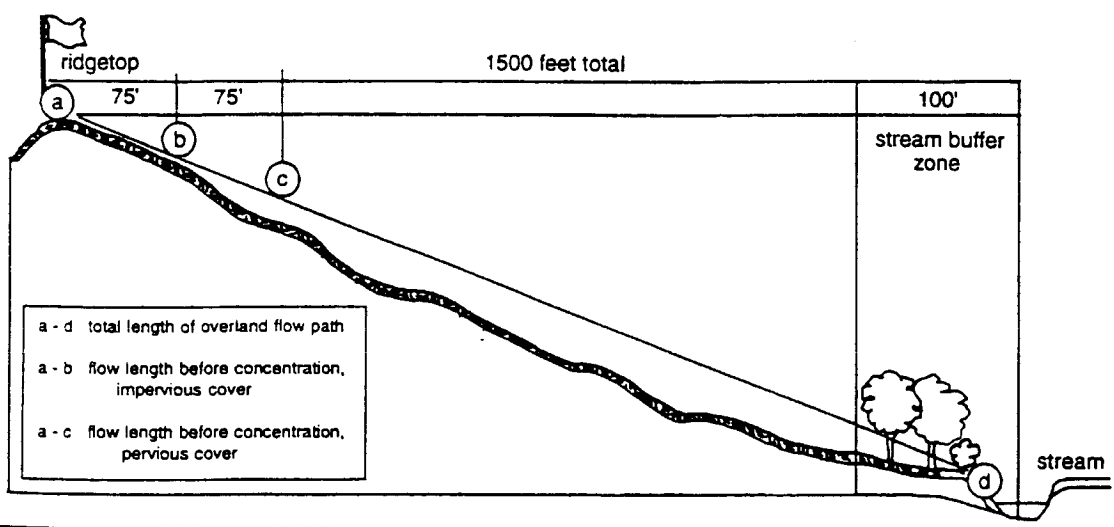

R0079676

**Table 1: Twenty Benefits of Urban Stream Buffers**  
*(f) = Benefit Amplified by or Requires Forest Cover*

1. **Reduces watershed imperviousness by 5%.** An average buffer width of 100 feet protects up to 5% of watershed area from future development.
2. **Distances areas of impervious cover from the stream.** More room is made available for placement of stormwater practices, and septic system performance is improved. *(f)*
3. **Reduces small drainage problems and complaints.** When properties are located too close to a stream, residents are likely to experience and complain about backyard flooding, standing water, and bank erosion. A buffer greatly reduces complaints.
4. **Stream "right of way" allows for lateral movement.** Most stream channels shift or widen over time; a buffer protects both the stream and nearby properties.
5. **Effective flood control.** Other, expensive flood controls are not necessary if buffer includes the 100-yr floodplain.
6. **Protection from streambank erosion.** Tree roots consolidate the soils of floodplain and stream banks, reducing the potential for severe bank erosion. *(f)*
7. **Increases property values.** Homebuyers perceive buffers as attractive amenities to the community. 90% of buffer administrators feel buffers have a neutral or positive impact on property values. *(f)*
8. **Increased pollutant removal.** Buffers can provide effective pollutant removal for development located within 150 feet of the buffer boundary, when designed properly.
9. **Foundation for present or future greenways.** Linear nature of the buffer provides for connected open space, allowing pedestrians and bikes to move more efficiently through a community. *(f)*
10. **Provides food and habitat for wildlife.** Leaf litter is the base food source for many stream ecosystems; forests also provide woody debris that creates cover and habitat structure for aquatic insects and fish. *(f)*
11. **Mitigates stream warming.** Shading by the forest canopy prevents further stream warming in urban watersheds. *(f)*
12. **Protection of associated wetlands.** A wide stream buffer can include riverine and palustrine wetlands that are frequently found along the stream corridor.
13. **Prevent disturbance to steep slopes.** Removing construction activity from these sensitive areas is the best way to prevent severe rates of soil erosion. *(f)*
14. **Preserves important terrestrial habitat.** Riparian corridors are important transition zones, rich in species. A mile of stream buffer can provide 25-40 acres of habitat area. *(f)*
15. **Corridors for conservation.** Unbroken stream buffers provide "highways" for migration of plant and animal populations. *(f)*
16. **Essential habitat for amphibians.** Amphibians require both aquatic and terrestrial habitats and are dependent on riparian environments to complete their life cycle. *(f)*
17. **Fewer barriers to fish migration.** Chances for migrating fish are improved when stream crossings are prevented or carefully planned.
18. **Discourages excessive storm drain enclosures/channel hardening.** Can protect headwater streams from extensive modification.
19. **Provides space for stormwater ponds.** Stream buffers can be an ideal location for properly placed stormwater practices that remove pollutants and control flows from urban areas.
20. **Allowance for future restoration.** Even a modest buffer provides space and access for future stream restoration, bank stabilization, or reforestation.



The ability of a particular buffer to actually realize its many benefits depends on how well the buffer is planned or designed. In this article, we present a more detailed scheme for stream buffer design, drawn from field research and local experience across the country. The suggested urban stream buffer criteria are based on 10 practical performance criteria that govern how a buffer will be sized, delineated, managed, and crossed (Table 2). In addition, the buffer design contains several provisions to respect the property rights of adjacent landowners.

### Criteria 1: Minimum Total Buffer Width

Most local buffer criteria are composed of a single requirement that the buffer be a fixed and uniform width from the stream channel. Urban stream buffers range from 20 to 200 feet in width on each side of the stream according to a national survey of 36 local buffer programs, with a median of 100 feet (Heraty, 1993). Most jurisdictions arrived at their buffer width requirement by borrowing other state and local criteria, local experience, and, finally, through political compromise during the buffer adoption process. Most communities require that the buffer fully incorporate all lands within the 100-year floodplain, and others may extend the buffer to pick up adjacent wetlands, steep slopes or critical habitat areas.

In general, a minimum base width of at least 100 feet is recommended to provide adequate stream protection. In most regions of the country, this requirement translates to a buffer that is perhaps three to five mature trees wide on each side of the channel.

### Criteria 2: Three-Zone Buffer System

Effective urban stream buffers are divided into three lateral zones: streamside, middle core, and outer zone. Each zone performs a different function, and has a different width, vegetative target and management scheme, as follows:

- The *streamside zone* protects the physical and ecological integrity of the stream ecosystem. The vegetative target is mature riparian forest that can provide shade, leaf litter, woody debris and erosion protection to the stream. The minimum width is 25 feet from each stream bank—about the distance of one or two mature trees from the stream bank. Land use is highly restricted and is limited to stormwater channels, footpaths, and a few utility or roadway crossings.
- The *middle zone* extends from the outward boundary of the streamside zone, and varies in width, depending on stream order, the extent of the 100-year floodplain, adjacent steep slopes and protected wetland areas. Its functions are to protect key components of the stream and provide

**Table 2: Nuts and Bolts of an Urban Stream Buffer**

- Minimum total width of 100 feet, including floodplain
- Zone-specific goals and restrictions for the outer, middle, and streamside zones
- Adopt a vegetative target based on predevelopment plant community
- Expand the width of the middle zone to pick up wetlands, slopes and larger streams
- Use clear and measurable criteria to delineate the origin and boundaries of the buffer
- The number and conditions for stream and buffer crossings should be limited
- The use of buffer for stormwater runoff treatment should be carefully prescribed
- Buffer boundaries should be visible before, during, and after construction
- Buffer education and enforcement are needed to protect buffer integrity

further distance between upland development and the stream. The vegetative target for this zone is also mature forest, but some clearing may be allowed for stormwater management, access, and recreational uses. A wider range of activities and uses are allowed within this zone, e.g., recreation, bike paths, and stormwater practices. The minimum width of the middle core is about 50 feet, but it is often expanded based on stream order, slope or the presence of critical habitats.

- The *outer zone* is the buffer's buffer, an additional 25-foot setback from the outward edge of the middle zone to the nearest permanent structure. In most instances, it is a residential backyard. The vegetative target for the outer zone is usually turf or lawn, although the property owner is encouraged to plant trees and shrubs, and thus increase the total width of the buffer. Very few uses are restricted in this zone. Indeed, gardening, compost piles, yard wastes, and other common residential activities are promoted within the zone. The only major restrictions are no septic systems and no new permanent structures.

### Criteria 3: Predevelopment Vegetative Target

The ultimate vegetative target for the streamside and middle zone of most urban stream buffers should be specified as the predevelopment riparian plant community—usually mature forest. Notable exceptions include prairie streams of the Midwest, or arroyos of the arid West, that may have a grass or shrub cover in the



R0079678

riparian zone. In general, the target should be based on the natural vegetative community present in the floodplain, as determined from reference riparian zones.

A vegetative target has several management implications. First, if the streamside zone does not currently meet its vegetative target, it should be managed to ultimately achieve it. For example, a grassy area should be allowed to grow into a forest over time. In some cases, active reforestation may be necessary to speed up the successional process. Second, a vegetative target implies that the buffer will contain mostly native species adapted to the floodplain. Thus, non-native or invasive tree, shrub and vine species should be avoided when revegetating the buffer. Removal of exotic shrubs and vines (e.g. multiflora rose or honeysuckle) that are often prevalent along the buffer edge should be encouraged.

#### Criteria 4. Buffer Expansion and Contraction

Many communities require that the minimum width of the buffer be expanded under certain conditions. Thus, while the streamside and outer zones of the buffer are fixed, the width of the middle zone may vary. Specifically, the average width of the middle zone can be expanded to include:

- The full extent of the 100-year floodplain
- All undevelopable steep slopes (> 25%)
- Steep slopes (five to 25% slope, at four additional feet of slope per 1% increment of slope above 5%)
- Adjacent delineated wetlands or critical habitats

The middle zone also expands to protect streams of higher order or quality in a downstream direction. For example, the width of the middle zone may increase from 75 feet (for first- and second-order streams) to 100 feet (for third- and fourth-order streams) and as much as 125 feet for fifth- or higher order streams/rivers. The width of the buffer can also be contracted in some circumstances to accommodate unusual or historical development patterns, shallow lots, stream crossings, or storm-water ponds (see Criteria 10).

#### Criteria 5: Buffer Delineation

Three key decisions must be made when delineating the boundaries of a buffer. At what mapping scale will streams be defined? Where does the stream begin and the buffer end? And from what point should the inner edge of the buffer be measured?

The *mapping unit*. The traditional mapping scale used to define the stream network are the bluelines present on USGS 7.5 minute quadrangle maps (1 inch = 2,000 feet). It should be kept in mind that bluelines are only a first approximation for delineating streams, as this scale does not always reveal all first order perennial streams or intermittent channels in the landscape or

precisely mark the transition between the two. Consequently, the actual location of the stream channel can only be confirmed in the field.

The *origin of a first order stream* is always a matter of contention. As a practical rule, the origin of the stream can be defined as the point where the intermittent stream forms a distinct channel, as indicated by the presence of an unvegetated streambed and high water marks. Other regions define the origin of a stream as the upper limit of running water during the wettest season of the year. Problems are frequently encountered when the stream network has been extensively modified by prior agricultural drainage practices.

The *inner edge* of the buffer can be defined from the centerline of small first- or second-order streams. The accuracy of this method is questionable in higher order streams with wider channels. Thus, the inner edge of the buffer is measured from the top of each streambank for third and higher order streams.

#### Criteria 6. Buffer Crossings

Two major goals of a stream buffer network are to maintain an unbroken corridor of riparian forest and maintain the upstream and downstream passage of fish in the stream channel. From a practical standpoint, it is not always possible to meet both goals everywhere along the stream buffer network. Some provision must be made for linear forms of development that must cross the stream or the buffer (Figure 2), such as roads, bridges, fairways, underground utilities, enclosed storm drains or outfall channels.

It is still possible to minimize the impact to the continuity of the buffer network and fish passage. Performance criteria should specifically describe the conditions under which the stream or its buffers can be crossed. Some performance criteria could include:

- *Crossing width*. Use the minimum width necessary to allow for maintenance access.
- *Crossing angle*. Direct right angles are preferred over oblique crossing angles, since they require less clearing in the buffer.
- *Crossing frequency*. Only one road crossing is allowed within each subdivision, and no more than one fairway crossing is allowed for every 1,000 feet of buffer.
- *Crossing elevation*. All direct outfall channels should discharge at the invert elevation of the stream. Underground utility and pipe crossings should be located at least three feet below the stream invert, so that future channel erosion does not expose them, creating unintentional fish barriers. All roadway crossings and culverts should be capable of passing the ultimate 100-year flood

**Figure 2: Crossing the Stream Buffer: Guidance on Minimizing Disruption to the Stream Network**

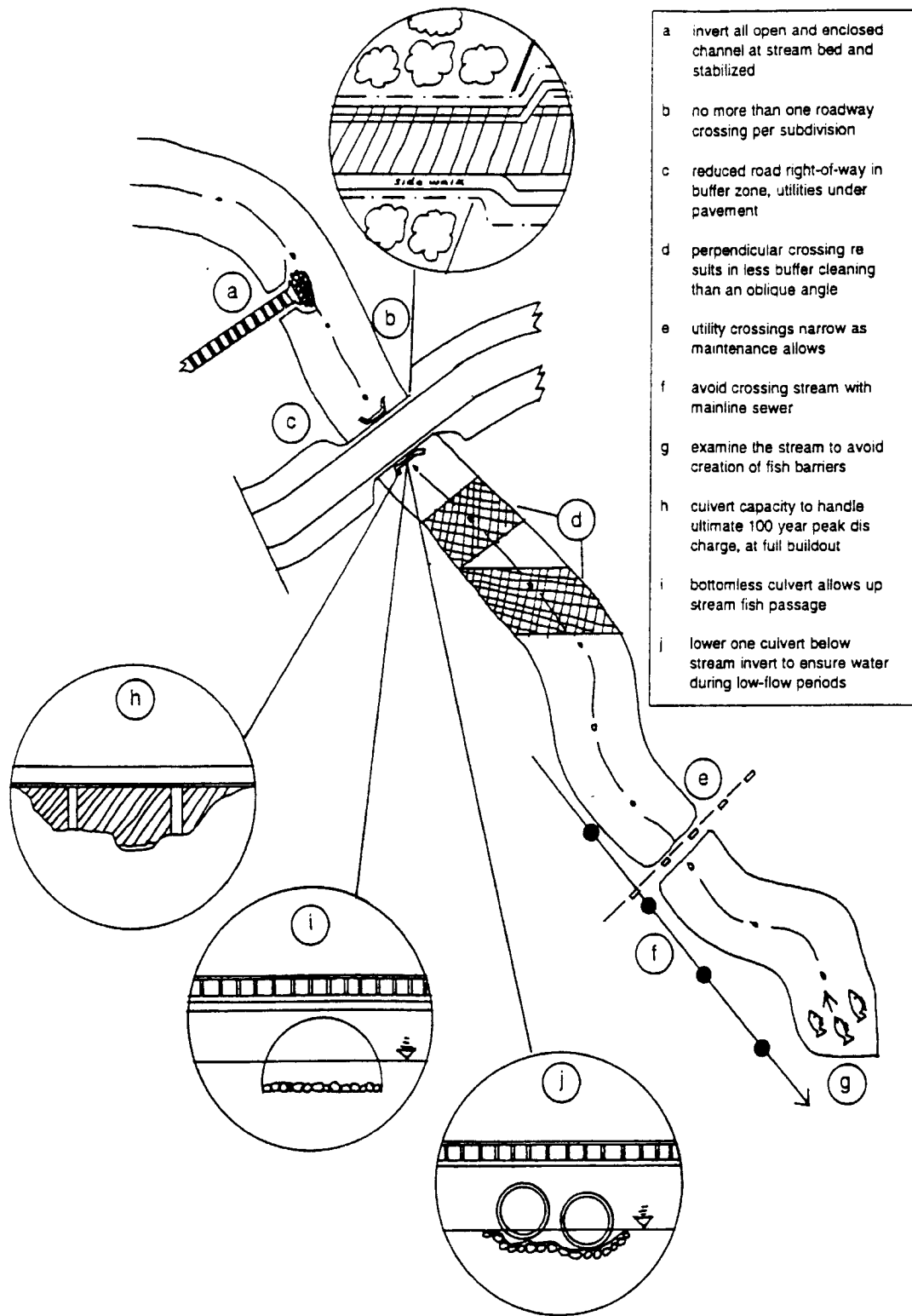

5

R0079680

event. Bridges should be used in lieu of culverts when crossings require a 72 inch or greater diameter pipe. The use of corrugated metal pipe for small stream crossings should be avoided, as they tend to create fish barriers. The use of slab, arch or box culverts are much better alternatives. Where possible, the culvert should be "bottomless" to ensure passage of water during dry weather periods (i.e., the natural channel bottom should not be hardened or otherwise encased).

#### Criteria 7: Stormwater Runoff

Buffers can be an important component of the stormwater treatment system at a development site. They cannot, however, treat all the stormwater runoff generated within a watershed (generally, a buffer system can only treat runoff from less than 10% of the contributing watershed to the stream). Therefore, some kind of structural stormwater practice must be installed to treat the quantity and quality of stormwater runoff from the remaining 90% of the watershed. More often than not, the most desirable location for the practices is within or adjacent to the stream buffer. The following guidance is recommended for integrating stormwater practices into the buffer.

##### A. The Use of Buffers for Stormwater Treatment

The outer and middle zone of the stream buffer may be used as a combination grass/forest filter strip under very limited circumstances (Figure 3). For example, if the buffer cannot treat more than 75 feet of overland flow from impervious areas and 150 feet of pervious areas (backyards or rooftop runoff discharged to the backyard), the designer should compute the maximum runoff velocity for both the six-month and two-year storm designs from each contributing overland flow path, based on the slope, soil, and vegetative cover present. If the computation indicates that velocities will be erosive under either condition (greater than 3 fps for six-month storm, 5 fps for two-year storm), the allowable length of contributing flow should be reduced.

When the buffer receives flow directly from an impervious area, the designer should include curb cuts or spacers so that runoff can be spread evenly over the filter strip. The filter strip should be located three to six inches below the pavement surface to prevent sediment deposits from blocking inflow to the filter strip. A narrow stone layer at the pavements edge often works well.

The stream buffer can only be accepted as a stormwater filtering system if basic maintenance can be assured, such as routine mowing of the grass filter and annual removal of accumulated sediments at the edge of the impervious areas and the grass filter. An enforceable maintenance agreement that allows for public maintenance inspection is also helpful.

##### B. Location of Stormwater Ponds and Wetlands Within the Buffer

A particularly difficult management issue involves the location of stormwater ponds and wetlands in relation to the buffer. Should they be located inside or outside of the buffer? If they are allowed within the buffer, where exactly should they be put? Some of the possible options are outlined in Figure 3.

A number of good arguments can be made for locating ponds and wetlands within the buffer or on the stream itself. Constructing ponds on or near the stream, for example, affords treatment of the greatest possible drainage area, making construction easier and cheaper. Second, ponds and wetlands require the dry weather flow of a stream to maintain water levels and prevent nuisance conditions. Lastly, ponds and wetlands add a greater diversity of habitat types and structure, and can add to the total buffer width in some cases. On the other hand, placing a pond or wetland in the buffer can create environmental problems, including the localized clearing of trees, the sacrifice of stream channels above the stormwater practice, the creation of a barrier to fish migration, modification of existing wetlands, and stream warming.

Locating ponds and wetlands in buffers will always be a balancing act. Given the effectiveness of stormwater ponds and wetlands in removing pollutants, it is generally not advisable to completely prohibit their use within the buffer. It does make sense, however, to choose pond and wetland sites carefully. In this respect, it is useful to consider possible performance criteria that restrict the use of ponds or wetlands:

- A maximum contributing area (e.g. 100 acres)
- The first 500 feet of stream channel
- Clearing of the streamside buffer zone only for the outflow channel (if the pond is discharging from the middle zone into the stream)
- Off-line locations within the middle or outer zone of the buffer
- Use ponds only to manage stormwater quantity within the buffer

#### Criteria 8: Buffers During Plan Review and Construction

The limits and uses of the stream buffer system should be well defined during each stage of the development process—from initial plan review through construction. The following steps are helpful during the planning stage:

- Require that the buffer be delineated on preliminary and final concept plans
- Verify the stream delineation in the field

R0079681

Figure 3: Options for Locating Stormwater Ponds Within the Stream Buffer Network

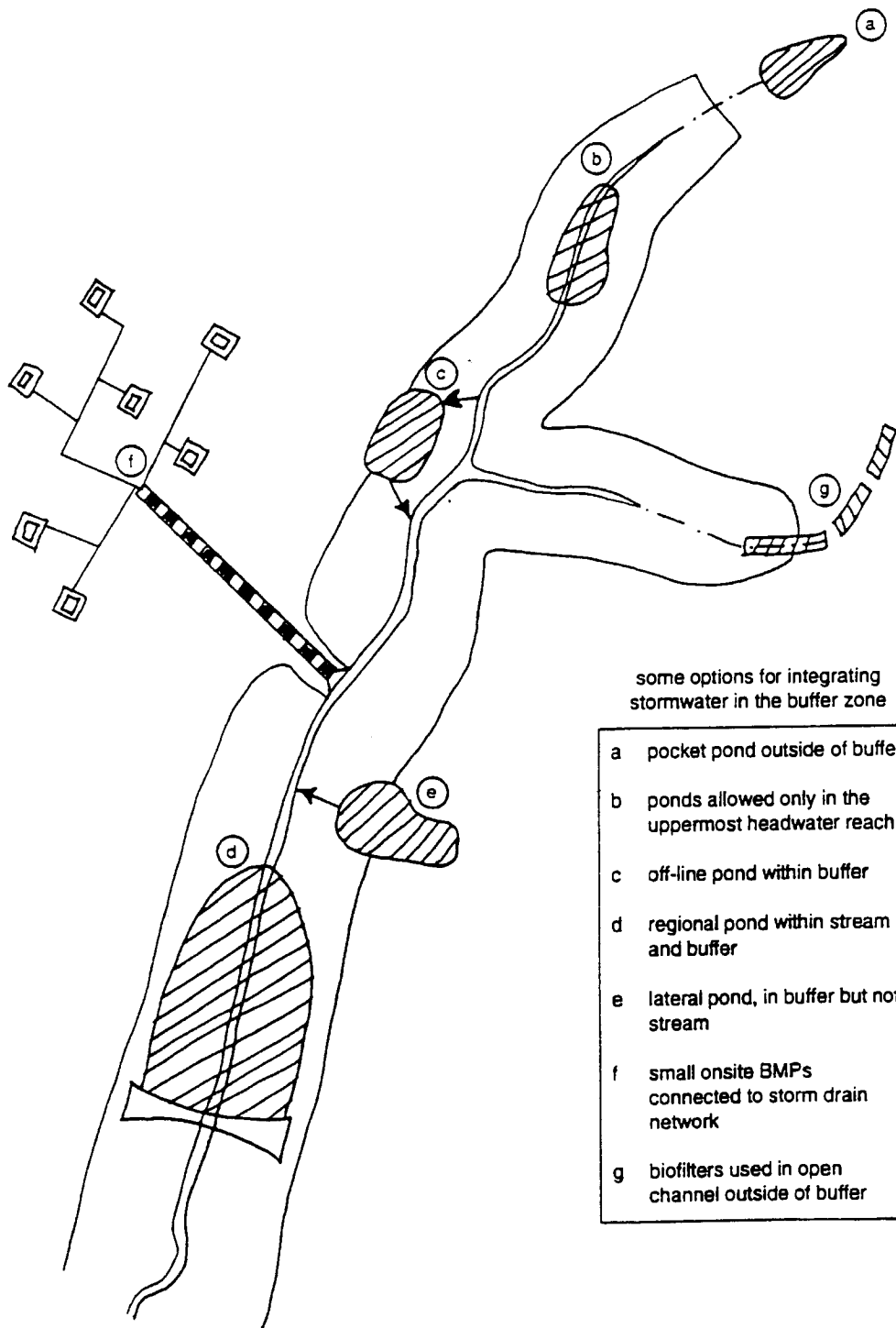

some options for integrating stormwater in the buffer zone

- a pocket pond outside of buffer
- b ponds allowed only in the uppermost headwater reach
- c off-line pond within buffer
- d regional pond within stream and buffer
- e lateral pond, in buffer but not stream
- f small onsite BMPs connected to storm drain network
- g biofilters used in open channel outside of buffer

5

R0079682

- Check that buffer expansions are computed and mapped properly
- Check suitability of use of buffer for stormwater treatment
- Ensure that the other stormwater practices are properly integrated in the buffer
- Examine any buffer crossings for problems

Stream buffers are vulnerable to disturbance during construction. Steps to prevent encroachment during this stage include:

- Mark buffer limits on all plans used during construction (i.e., clearing and grading plans, and erosion and sediment control plans)
- Conduct a preconstruction stakeout of buffers to define limits of disturbance
- Mark the limits of disturbance with silt or snow fence barriers, and signs to prevent the entry of construction equipment and stockpiling
- Familiarize contractors with the limits of disturbance during a preconstruction walk-through

#### **Criteria 9: Buffer Education and Enforcement**

Future integrity of the buffer system requires a strong education and enforcement program. Two primary goals are to make the buffer “visible” to the community, and to encourage greater buffer awareness and stewardship among adjacent residents. There are several simple steps that can accomplish these goals:

- Mark the buffer boundaries with permanent signs that describe allowable uses
- Educate buffer owners about the benefits and uses of the buffer with pamphlets, streamwalks and meetings with homeowners associations
- Ensure that new owners are fully informed about buffer limits/uses when property is sold or transferred
- Engage residents in a buffer stewardship program that includes reforestation and backyard “bufferscaping” programs
- Conduct annual bufferwalks to check on encroachment

The underlying theme of education is that most encroachment problems reflect ignorance rather than contempt for the buffer system. The awareness and education measures are intended to increase the recognition of the buffer within the community. Not all residents, however, will respond to this effort, and some kind of limited enforcement program may be necessary (Schueler, 1994). This usually involves a series of correction notices and site visits, with civil fines used as a last resort if compliance is not forthcoming. Some buffer

ordinances have a further enforcement option, whereby the full cost of buffer restoration is charged as a property lien (Schueler, 1994). A fair and full appeals process should accompany any such enforcement action.

#### **Criteria 10: Buffer Flexibility**

In most regions of the country, a 100-foot buffer will take about 5% of the total land area in any given watershed out of production (Schueler, 1995b). While this constitutes a relatively modest land reserve at the watershed scale, it can be a significant hardship for a landowner whose property is adjacent to a stream. Many communities are legitimately concerned that stream buffer requirements could represent an uncompensated taking of private property. These concerns can be eliminated if a community incorporates several simple measures to ensure fairness and flexibility when administering its buffer program. As a general rule, the intent of the buffer program is to modify the location of development in relation to the stream but not its overall intensity. Some flexible measures in the buffer ordinance include the following.

##### *Maintaining Buffers in Private Ownership*

Buffer ordinances that retain property in private ownership generally are considered by the courts to avoid the takings issue, as buffers provide compelling public safety, welfare and the environmental benefits to the community (Table 1) that justify partial restrictions on land use. Most buffer programs meet the “rough proportionality” test recently advanced by the Supreme Court for local land use regulation (Hornbach, 1993). Indeed stream buffers are generally perceived to have a neutral or positive impact on adjacent property value. The key point is that the reservation of the buffer cannot take away all economically beneficial use for the property. Four techniques—buffer averaging, density compensation, conservation easements, and variances—can ensure that the interests of the property owners are protected.

##### *Buffer Averaging*

In this scheme, a community provides some flexibility in the width of the buffer. The basic concept is to permit the buffer to become narrower at some points along the stream (e.g., to allow for an existing structure or to recover a lost lot), as long as the average width of the buffer meets the minimum requirement. In general, buffer narrowing is limited, such that the streamside zone is not disturbed, and no new structures are allowed within the 100-year floodplain (if this is a greater distance).

##### *Density Compensation*

This scheme grants a developer a credit for additional density elsewhere on the site, in compensation for developable land that has been lost due to the buffer

requirement. Developable land is defined as the portion of buffer area remaining after the 100-year floodplain, wetland, and steep slope areas have been subtracted. Credits are granted when more than 5% of developable land is consumed, using the scale shown in Table 2. The density credit is accommodated at the development site by allowing greater flexibility in setbacks, frontage distances or minimum lot sizes to squeeze in "lost lots." Cluster development also allows the developer to recover lots that are taken out of production due to buffers and other requirements. The intent of stream buffers is to modify the location but not the intensity of development. Buffer averaging, density compensation, and variances can all minimize the impact on property owners.

#### Conservation Easements

Landowners should be afforded the option of protecting lands within the buffer by means of a perpetual conservation easement. The easement conditions the use of the buffer, and can be donated to a land trust as a charitable contribution that can reduce an owner's income tax burden. Alternatively, the conservation easement can be donated to a local government, in exchange for a reduction or elimination of property tax on the parcel.

#### Variances

The buffer ordinance should have provisions that enable a existing property owner to be granted a variance or waiver, if the owner can demonstrate severe economic hardship or unique circumstances make it impossible to meet some or all of the buffer requirements. The owner should also have access to a defined appeals process should the request for a variance be denied.

—TRS

#### Summary

Urban stream buffers are an integral element of any local stream protection program. By adopting some of these rather simple performance criteria, communities can make their stream buffers more than just a line on a map. Better design and planning also ensure that communities realize the full environmental and social benefits of stream buffers.

#### References

- Burns, D. 1992. *Environmental Protection and Resource Conservation Plan*. City of Lacey, WA 169 pp.
- Desbonnet, A. P. Pogue, V. Lee and N. Wolff. 1994. *Vegetated Buffers in the Coastal Zone: A Summary Review and Bibliography*. Coastal Resources Center. University of Rhode Island. 72 pp.

**Table 2: Example of the Use of Density Credits to Compensate Developers for Excessive Land Consumption by Buffers (Burns, 1992)**

Percent of site lost to buffers	Density * credit
1 to 10 %	1.0
11 to 20%	1.1
21 to 30%	1.2
31 to 40%	1.3
41 to 50%	1.4
51 to 60% **	1.5
61 to 70% **	1.6
71 to 80% **	1.7
81 to 90% **	1.8
91 to 99% **	1.9

\* Additional dwelling units allowed over base density (1.0)

\*\* Credit may be transferred to a different parcel

Heraty, M. 1993. *Riparian Buffer Programs: A Guide to Developing and Implementing a Riparian Buffer Program as an Urban Stormwater Best Management Practice*. Metro. Wash. Council Gov. U.S. EPA Office of Oceans, Wetlands and Watersheds. 152 pp.

Hornbach, W. 1993. "Private Property and Community Rights—What Communities Can Still Do After Development." *Lucas* 3(1):14.

Leopold *et al.*, 1964. *Fluvial Processes in Geomorphology*. W.H. Freeman, San Francisco, CA 509 pp.

Schueler, T. 1994. *The Stream Protection Approach*. Center for Watershed Protection. Terrene Institute, Washington, DC 66 pp.

Schueler, T. 1995a. "The Importance of Imperviousness." *Watershed Protection Techniques*. 1(3): 100-111.

Schueler, T. 1995b. *Site Planning for Stream Protection*. Center for Watershed Protection/Metropolitan Washington Council of Governments. Silver Spring, MD 320 pp.



R0079684

# Urbanization, Stream Buffers, and Stewardship in Maryland

by Dr. Glenn E. Moglen, Department of Civil and Engineering, University of Maryland

**T**he stream buffer is the region immediately beyond the banks of a stream that serves to limit the entrance of sediment, pollutants, and nutrients to the stream itself. When forested, a stream buffer promotes bank stability and serves as a major control of water temperature (Leopold, 1997). From a biological perspective, the importance of a healthy, intact riparian zone has only been understood for the last 20 years (Rapp, 1997).

Most counties in Maryland have some kind of regulations in place to keep development away from perennial streams and tidal waters, whether through local stream buffer, steep slope, flood plain or critical area ordinances. However, the quality and extent of the buffer varies markedly across the state.

This note documents recent trends in land conversion in urban, suburban and rural counties in Maryland, with a strong emphasis on how these changes have affected land cover within the stream buffer zone. The study examines how the composition of land cover in

the buffer zone changes in response to development, with respect to forest, agricultural and urban cover within 100 feet of each streambank.

### *Methods and Data Sources*

This study was based on analyses performed with a Geographic Information System (GIS). The key data source for land use was the Generalized Land Use coverages produced by the Maryland Office of Planning (MOP) for 1990, 1994, and 1997. These data were derived and interpreted from high altitude aerial photography and satellite imagery (SPOT 1994 and 1997) with a 10 acre minimum mapping unit. Land use was classified by 24 different descriptors, but was more broadly reclassified as urban, agricultural, or forest for purposes of this study.

Stream locations within Maryland were determined from U.S. Environmental Protection Agency River Reach files (Dewald & Olsen, 1994). The modified GIS produced a digitized version of the Maryland

**5**

Figure 1: Map of Maryland Counties Analyzed in the Article



stream network at 1:100,000 scale. Past studies have shown that the extent of the drainage network is sensitively dependent on the map scale (Moglen and Beighley, in press). This same analysis undertaken at a finer 1:24,000 scale would have shown a greater number of first order streams. The 1:100,000 scale files used in this study were selected because of their general availability across the state of Maryland.

Although Schueler (1995) emphasizes that the stream buffer is not simply a "line on a map," this study characterizes buffers as precisely that. Polygons were generated for stream buffers extending exactly 100 and 200 feet to each side of the digitized tester streams. Figure 2 presents a typical segment of stream channel, illustrating the stream and a 200-foot buffer zone. The "buffered" area was compared to the land use coverages for 1990, 1994, and 1997. Statistics were compiled to document overall changes in land use distributions within each county, as well as changes in land cover within the stream buffer zone.

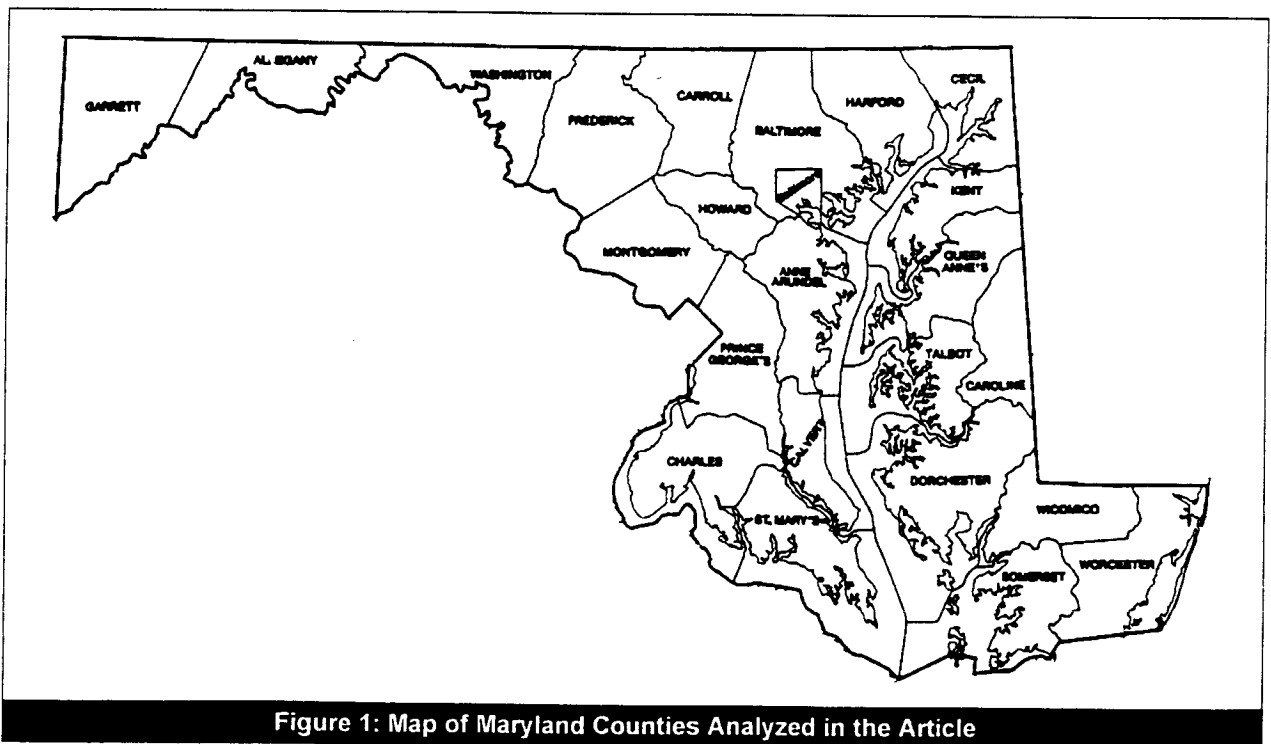
#### *Trends in Land Conversion by County*

Urban land use cover across the state of Maryland increased by 3.9% between 1990 to 1997, cumulatively representing the conversion of 390 square miles of land (see Table 1). Urban land conversion came at the expense of agricultural land (2.2% loss) and forest land (1.5% loss). The remaining 0.2% loss was spread across

the "water," "wetland," and "other" categories.

#### *Patterns of Urbanization by County*

While some trends were evident at the statewide scale, land use changes at the county scale were much more variable. Land and buffer conversion was even more striking when viewed on a county basis (see Figure 1).

For purposes of analysis, each county was classified as urban, suburban or rural, based on the fraction of urban land present in 1997. Five counties were considered "urban," as more than 35% of their land area was classified as urban. Urban counties grew at the fastest pace over the eight year period, with an average rate of growth of 6.5%. Nine counties were classified as suburban, with 12% to 25% of their land area in the urban category. These suburban counties experienced a moderate rate of growth (4.4%) in urban area during the study period. Finally, nine counties were considered rural, as urban land comprised less than 12% of their total area. These rural counties experienced the slowest rate of growth (2.5%) over the study period.

As might be expected, the urban growth occurred by converting forest and agricultural lands. The loss of forests for rural, suburban and urban counties was 0.8%, 2.1% and 2.5%, respectively, during this eight

**Table 1: Overall Land Use Distribution and Change in Land Use Distribution by County (Negative changes indicate loss of land cover in indicated category.)**

*County	1997				Changes: 1990 to 1997		
	Urban (%)	Agriculture (%)	Forest (%)	Other (%)	Urban (%)	Agriculture (%)	Forest (%)
Anne Arundel (U)	37.8	17.7	41.1	3.5	5.2	-1.1	-3.6
Baltimore (U)	35.0	27.2	33.7	4.1	3.6	-1.8	-1.6
Howard (U)	35.3	31.4	32.2	1.1	9.8	-3.8	-4.8
Montgomery (U)	41.7	26.3	29.4	2.6	6.1	-7.1	1.8
Prince Georges (U)	38.5	16.2	40.9	4.4	8.0	-2.4	-4.5
Calvert (S)	24.2	20.5	49.4	6.0	8.4	-1.7	-6.6
Carroll (S)	17.8	57.7	23.4	1.0	5.0	-4.6	-0.2
Cecil (S)	13.5	44.3	37.8	4.4	2.8	-1.8	-1.0
Charles (S)	16.0	20.3	58.8	5.0	3.4	-0.3	-3.0
Frederick (S)	12.2	57.5	29.7	0.6	3.6	-2.4	-1.0
Harford (S)	22.9	38.3	33.5	5.3	3.2	-2.0	-1.2
St. Marys (S)	15.6	27.2	53.3	3.8	4.2	-2.2	-1.8
Washington (S)	14.1	47.9	35.9	2.1	4.2	-2.4	-1.8
Wicomico (S)	12.4	35.7	43.5	8.4	4.9	-2.6	-2.1
Allegany (R)	10.5	12.3	76.1	1.2	2.5	-0.4	-2.1
Caroline (R)	7.5	57.5	31.4	3.6	2.3	-2.0	-0.3
Dorchester (R)	4.4	31.8	34.1	29.8	2.2	-1.3	-0.7
Garrett (R)	6.9	22.5	68.6	2.1	1.7	-1.5	-0.3
Kent (R)	5.5	61.6	24.6	8.3	1.8	-1.8	0.1
Queen Annes (R)	7.6	62.6	26.4	3.4	2.2	-0.4	-1.5
Somerset (R)	5.8	25.7	43.3	25.1	2.6	-1.6	-0.8
Talbot (R)	11.1	57.5	23.2	8.2	5.3	-3.0	-2.0
Worcester (R)	6.7	30.3	54.7	8.3	2.2	-2.5	0.6

\* U = Urban, S = Suburban, R = Rural

R0079686

year period. Conversion of agricultural lands was even greater, with losses of 1.6%, 2.2% and 3.2% respectively in the rural, suburban and urban counties, respectively. Individual statistics on the county-wide loss of forest and agricultural cover are provided in Table 1.

Urban land conversion has uniformly come at the expense of agricultural land for every county in the state. In general, forest land was also lost across the state — as much as 6.6% was lost in Calvert County. A few counties reported gains in forest cover, most notably Montgomery County, which gained 1.8%, and Worcester, which gained 0.6% over this period.

#### *Trends in Stream Buffer Cover*

The stream buffer zone was considered to be in a desirable condition if it was in a forested or wetland land use as indicated by the "Total Buffered" columns in Table 2. The trends in land conversion within the 100-foot stream buffers are somewhat different. While urban land use increased by 1.9% in the buffer zone (about 8.3 square miles) between 1990 to 1997, forest cover actually increased by a modest 0.6%. Once again, the loser in this exchange was agriculture, which lost 2.1% of its share of the stream buffer zone over this

period. Since tidal and non-tidal wetlands are protected and preserved by both state and federal law, it was not surprising that changes in overall wetland land cover were found to be small, if not negligible. Taken together, the 100-foot stream buffer zone occupies approximately 5.2% of the total land area in Maryland.

On a county basis, the amount of forest cover in buffer zones was as low as 24.1% in Dorchester County, and as great as 76.6% in Charles County. In several Eastern Shore counties, tidal and non-tidal wetlands comprise more than 10% of land within the stream buffer zone. Indeed, more than 50% of the buffer areas are designated as wetlands, so the low forestation value for Dorchester county should be taken with the understanding that "buffering" still exists, but in the form of a wetland rather than forest (again, see Table 2). Although one might expect the rural counties to have relatively high forestation in the buffer zones, this was not always the case. In counties with less than 50% forestation in the buffer zones, a large fraction of the buffer zone was generally designated as agricultural land use, presenting the opportunity for significant buffer zone reforestation in coming years.

**Table 2: 100-Foot Stream Buffer Land Use Distribution and Change in Land Use Distribution by County (Negative changes indicate loss of land cover in indicated category.)**

*County	1997					Changes: 1990 to 1997				
	Urban (%)	Agri-culture (%)	Forest (%)	Wet-land (%)	Total Buffered (%)	Urban (%)	Agri-culture (%)	Forest (%)	Wet-land (%)	Total Buffered (%)
Anne Arundel (U)	21.4	7.9	67.6	3.1	70.7	1.7	-0.3	-1.0	0.0	-1.0
Baltimore (U)	21.8	18.0	58.6	1.4	60.0	0.2	-0.8	0.8	0.0	0.8
Howard (U)	18.2	19.8	61.6	0.3	61.9	3.3	-2.4	-0.2	-0.0	-0.2
Montgomery (U)	17.0	12.3	70.3	0.4	70.6	-0.3	-12.5	13.5	0.0	13.5
Prince Georges (U)	20.1	7.2	69.8	2.7	72.5	2.5	-0.4	-1.1	-0.4	-1.5
Calvert (S)	13.9	7.9	67.7	10.5	78.1	4.8	-0.2	-3.4	-0.8	-4.2
Carroll (S)	7.2	46.9	45.8	0.0	45.9	2.0	-4.0	2.1	-0.1	2.0
Cecil (S)	9.2	17.7	68.5	3.8	72.4	1.6	-0.6	-0.8	-0.2	-1.0
Charles (S)	7.4	9.7	76.6	6.2	82.8	1.4	-0.2	-1.2	-0.1	-1.3
Frederick (S)	6.9	53.7	39.3	0.0	39.3	1.2	-0.9	-0.2	0.0	-0.2
Harford (S)	12.3	28.2	54.7	4.9	59.5	0.9	-0.2	-0.9	0.3	-0.6
St. Marys (S)	11.1	16.0	68.0	4.7	72.6	2.2	-1.8	-0.3	-0.0	-0.3
Washington (S)	9.4	47.8	42.8	0.0	42.8	2.5	-1.7	-0.8	-0.0	-0.8
Wicomico (S)	10.0	17.5	50.7	21.7	72.4	3.4	-0.6	-1.4	-1.2	-2.6
Allegany (R)	11.8	13.5	74.6	0.0	74.7	3.4	-1.2	-2.2	0.0	-2.2
Caroline (R)	7.2	32.3	53.6	6.8	60.4	3.1	-0.7	-2.0	-0.4	-2.4
Dorchester (R)	3.6	17.9	24.1	54.3	78.3	2.0	-1.6	-0.3	-0.2	-0.5
Garrett (R)	7.7	16.8	73.8	1.7	75.4	1.3	-1.2	-0.1	-0.0	-0.1
Kent (R)	6.0	28.8	56.6	8.5	65.1	2.2	-6.5	5.0	-0.7	4.4
Queen Annes (R)	6.1	34.0	54.5	5.4	59.8	1.1	0.2	-1.0	-0.3	-1.3
Somerset (R)	3.8	11.9	31.6	52.6	84.3	1.9	-0.8	-0.6	-0.6	-1.2
Talbot (R)	15.8	40.5	35.7	8.0	43.7	7.8	-10.0	2.4	-0.3	2.1
Worcester (R)	4.1	13.3	65.1	17.1	82.2	1.4	-3.2	2.1	-0.5	1.6

\* U = Urban, S = Suburban, R = Rural

Although one might expect that urban counties would have relatively low forest cover in the buffer zone compared to the less densely developed counties, this was not the case. The five most urban counties averaged about 66% forest and wetland cover in the buffer zone, compared to 63% for suburban counties and 69% for rural counties. The key differences was in the composition of the non-forest cover in the buffer. In urban counties, only 13% of the buffer zone was agricultural cover, whereas this figure was about 25% in the rural and suburban counties.

Disturbing trends were noted in suburban counties that continued to lose forest cover within the buffer zone. It appears that developing counties, not the urban counties, are experiencing the greatest loss of forest cover. For example, Calvert County, which exhibited the greatest rate of urban growth, also showed the greatest loss of forest cover within the buffer zone (about 1.1% per year).

The analysis did have some heartening news. There was strong evidence that many counties have recently begun to slow, stop and even reverse the loss of forest cover in the buffer zone. In the first four years of the study, 75% of the counties recorded forest loss in the buffer zone, and 25% indicated no change in forest cover. In the last four years of the study, however, only 48% of counties recorded a loss of forest cover, and 52% actually gained forest cover in the buffer zone. Seven counties added more than 3% forest cover to their existing buffer zones during the 1994 to 1997 period.

The gains in forest cover appeared to be due to several factors: gradual succession of agricultural lands into forest, riparian reforestation efforts, and stronger enforcement of stream buffer and flood plain regulations. Of these factors, it appears that succession was probably the greatest factor, since agricultural cover was lost at a rate of 2.5% in the buffer zone during the study period. Clearly, croplands are reverting to forest either because they are now protected by a stream buffer or because they have been abandoned as suburban growth advances into the countryside.

The nature of existing adjacent land use appears to play a role in the ability to reforest the buffer zone. Typical residential and commercial developments, for example, do not offer much flexibility for reforestation after development. And indeed, only 13.3% of the reclaimed 100-foot buffer zones in Montgomery County came from formerly urban sources, with the remainder coming from agricultural use. Agricultural land provides much greater flexibility for buffer re-conversion, and contributed a disproportionately larger share of reclaimed buffers relative to overall land use distributions within all counties. Figure 3 illustrates the spatial location of reforested 100-foot stream buffers in Montgomery county. Forested buffers are most sparse in the southeastern part of the county, where the most dense

development has historically occurred and thereby constrains buffer reclamation.

#### *Implications: Buffer Zones at Risk*

Efforts to reforest the buffer zone can be successful, even in urban counties. This is illustrated by the strides made by Baltimore City and Montgomery County, among others. Furthermore, the goal to protect and reserve the stream buffer zone from development is not necessarily at odds with future development. Twelve Maryland counties all managed to undergo further urbanization while actually enhancing the amount of forest cover in their buffer zones in the last four years of the study.

Several counties that had low forest cover in the buffer zone and a large agricultural land use component — Talbot, Frederick, Washington, and Carroll counties — have potential to reclaim significant percentages of forest cover within the buffer zone in future years. Should the buffer zone become reforested in these formerly agricultural settings, the reclaimed stream buffers would likely lead to significant enhancement of stream water quality.

Urban development in Calvert County is illustrative of the most discouraging activities going on in the state. From 1994-1997, Calvert County underwent the greatest percentage change in urban land use (7.6%) within the state, while simultaneously undergoing the greatest loss in forested buffer zones within the state (3.4%). Lost wetlands totaled another 0.8%, also the greatest in the state. Ten other counties across the state followed a similar urbanization/deforestation pattern in the buffer.

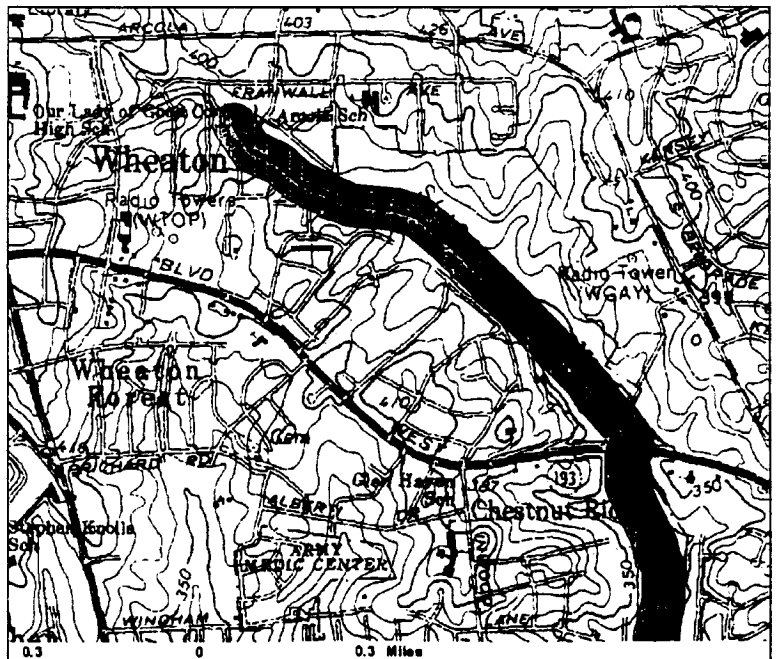
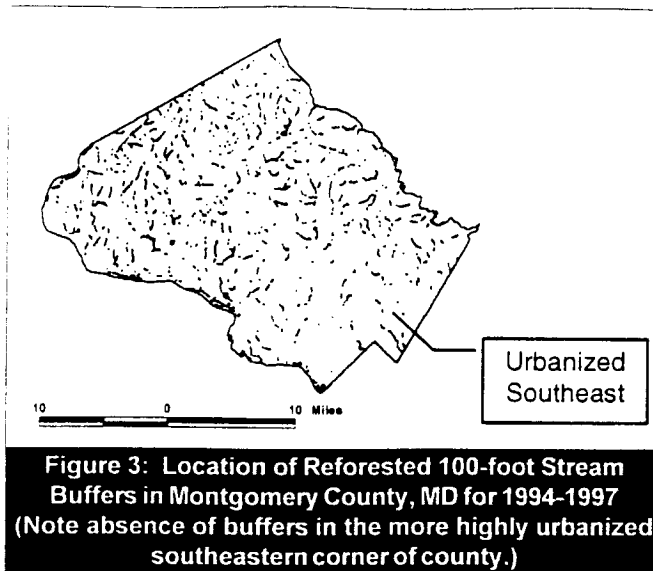

Figure 2: Sample Stream With 200-foot Buffer Identified (Background is U.S.G.S. 1:24,000 quadrangle map.)



These trends are unsettling not only because of their immediate negative impact on the stream buffer zone, but also because of the difficulty of reforestation after development. Better enforcement and more stringent stream buffer programs are most needed in these rural areas, but growing counties have the most to lose in terms of loss of potential development.

While the story told here is specific to Maryland, the general themes of the need for land use planning, conversion from agriculture to residential land, and reclamation of the stream buffer by forests in urban and agricultural settings surely extend to many other states. The data needed to perform similar studies in other states remains the same: digital land use coverage throughout the state for at least two different points in time, and a digitized stream network covering the same area. The existence and quality of the former (land use) may vary considerably depending on the state, while the availability of the latter (stream network) exists from the EPA (USEPA, 1999) if not from elsewhere.

The author has developed a sample ArcView program to facilitate the comparative analysis in other states. A planner possessing these two digital products may readily perform the same analyses presented here.

#### Summary

While continued urbanization has been a constant across the state, more than half of Maryland's counties have posted increases in forest cover in the stream buffer zone. Based on land use distributions in 1997, a number of counties were identified that have the potential to significantly enhance the amount of forest cover within their buffer zones. These counties have a large percentage of agricultural land use currently in this zone. It was observed that reforestation of the buffer zone after urban development has taken place is more difficult, and the

available width of the buffer zone is more limited. This highlights the need for sound environmental stewardship of the watershed as well as the necessity of crafting development plans that set aside stream buffers prior to development. Such planning is especially important in rural but rapidly growing counties that can quickly lose forest buffer zones over as short a span as a single decade.

#### Acknowledgments

The land use data used in preparation of this report was provided by the Maryland Office of Planning, Planning Data Services.

#### References

- Dewald, T., Olsen, M., 1994. *The EPA Reach File: A National Spatial Data Resource*. USEPA, Office of Research and Development.
- Leopold, L., 1997. *Water, Rivers, and Creeks*. University Science Books, Sausalito, CA.
- Moglen, G. and R. Beighley. (in press). "Using GIS to Determine the Extent of Gaged Streams in a Region." *Journal of Hydrologic Engineering*, ASCE.
- Rapp, V., 1997. *What the River Reveals: Understanding and Restoring Healthy Watersheds*. The Mountaineers, Seattle, WA.
- Schueler, T., 1995. "The Architecture of Urban Stream Buffers." *Wat. Prot. Techniques*. 1(4): 155-163.
- U.S. Environmental Protection Agency, 1999. *Office of Water, Basins Data Download*, <http://www.epa.gov/OST/BASINS/gisdata.html>.

# Invisibility of Stream and Wetland Buffers In the Field

**S**tream and wetland buffers are an increasingly popular watershed protection technique due to their apparent simplicity, low cost, ease of implementation, and presumed capability to protect resource areas (Figure 1). As a result, local governments across the country have incorporated stream and wetland buffer requirements into their development review process. Two recent studies, however, suggest that buffers might have limited usefulness as a watershed protection tool as they are currently enforced.

The key problem is that buffer boundaries are often invisible to property owners, contractors, and even the local governments themselves. Without defined boundaries, urban buffers face enormous pressure from encroachment, disturbance, and other incompatible uses.

The first study involved a survey of how buffer programs were administered in 36 jurisdictions around

the country (Heraty, 1993). In nearly every locale, developers were required to delineate a stream or wetland buffer on concept or final plans for purposes of development review. However, only half the jurisdictions required that buffer boundaries be clearly delimited on the plans for clearing/grading and sediment control.

This omission is significant as boundaries are needed on the plans to stake out the limits of disturbance around the buffer during construction. The absence of buffer limits on construction-stage plans increases the risk that contractors will encroach or disturb the buffer.

Local governments also contribute to the invisibility of buffers by not recording their boundaries on their own official maps. For example, Heraty found that only one-third of all survey respondents recorded buffer limits on their official property maps. Without buffer maps, local governments cannot systematically inspect

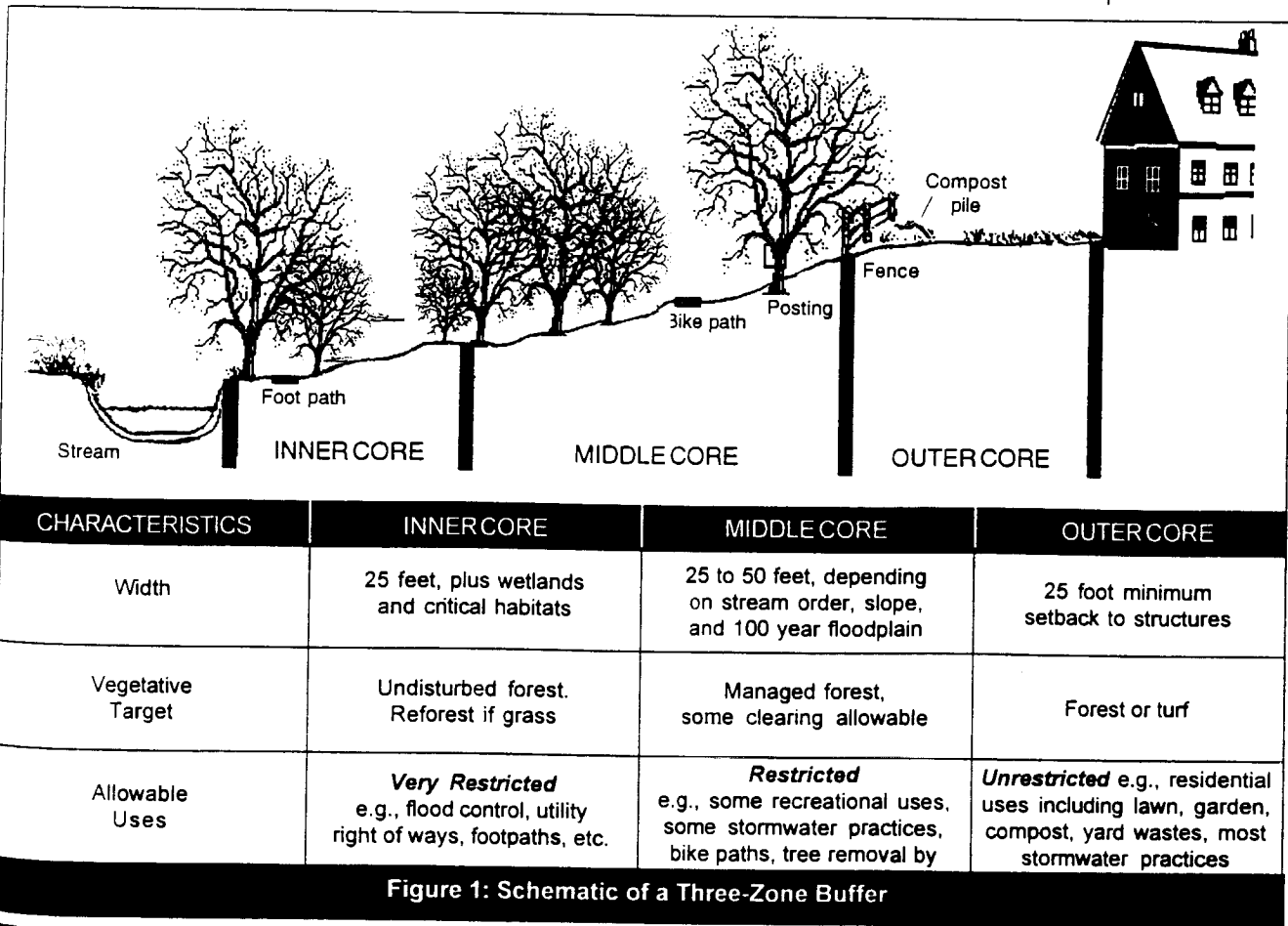

**Figure 1: Schematic of a Three-Zone Buffer**



**Table 1: Acceptable and Unacceptable Uses Within Stream and Wetland Buffers (Heraty, 1993)**

Use	Allowed (%)	Denied (%)
Footpaths	60	8
Utility line Crossings	52	5
Water Dependent Uses	45	10
Bike Paths	30	15
Stormwater Practices	28	10
Home Additions/Decks/Gazebos	10	55
Maintenance for Flood Control	Often Allowed	
Pumphouses	Restricted	
Sewage Treatment Plants	Restricted	
Golf Courses	Restricted	
Campgrounds	Restricted	
Timber Harvesting	Restricted	
Hydropower	Restricted	
Roads/Bridges	Restricted	
Athletic Fields	Restricted	
Playground Equipment	Restricted	
Compost/Yard Wastes	Unrestricted	
Landscaping	Unrestricted	
No Uses Permitted (30%)		
No Uses Denied (15%)		

*Percentages of Buffer Programs that specifically allow or deny a given use. The "Restricted" and "Unrestricted" entries refer to other stream buffer uses that are not commonly addressed in local ordinances.*

5

or manage their network of buffers, nor can they easily evaluate the impact of future development projects or proposed uses at individual locations in the buffer network.

Nearly 90% of all buffer areas are in private ownership. For most property owners, the boundaries of stream and wetland buffers are particularly invisible. Over 60% of the local governments surveyed indicated that most individual property owners were unaware of either the boundary or the purpose of a buffer. This is not surprising, given that a majority of local governments made little or no effort to inform property owners about buffer boundaries or maintenance requirements. Only 15% of all jurisdictions surveyed required that buffer boundaries be posted or fenced.

Usually, the only notification given to property owners about buffer limits were one-time legal disclosures, such as notes on the deed of sale, language in a homeowner association charter, and prescribed notice upon property resale. Few jurisdictions employed techniques to educate property owners about buffers such as pamphlets, postings, community association meetings, or individual maintenance agreements.

Heraty's survey also revealed that many community officials felt that their buffer programs could be

greatly strengthened. For example, many were of the opinion that consultants were not always accurately delineating buffer boundaries. However, they did not have enough staff resources for technical assistance or field verification. In nearly every jurisdiction, inspection was confined to a single and often cursory visit at the end of construction. Subsequent post-construction "bufferwalks" were rarely or never performed.

Over time, many local governments have found their buffer ordinances were too simplistic and lacked a clear vegetative goal. For example, Heraty found that two-thirds of all buffer programs required maintenance of the pre-development vegetative cover within the buffer, regardless of whether it was grass, weeds, or trees. About 10% of buffer programs specified retention of grass or meadow areas, and twenty percent had no vegetative cover at all. Given the importance of riparian forests in the ecology of streams in the more humid regions of the country, it would seem appropriate to clearly specify mature riparian forest cover as the ultimate vegetative goal for these buffer systems (see article 43).

As a commons area, buffers are subject to great pressure from property owners and adjacent users. In retrospect, planners have had considerable problems in defining what are acceptable, and what are unacceptable, uses of buffers in urban areas. A long list of the many proposed uses for buffers is provided in Table 1. As can be seen, planners must reconcile many different, competing, and very strong pressures in buffer areas (such as recreation, water-dependent use, utilities, and even stormwater management practices).

One possible model (loosely adapted from Welsch, 1991) involves a series of management zones within the buffer. Unique vegetation targets and permissible uses are established in each zone. The most natural vegetation target (and most restrictive use) is located on the interior boundary of the buffer. A schematic of a three zone buffer management scheme is shown in Figure 1.

Some idea of the many pressures placed on urban buffer systems was revealed in Cooke's 1991 study of 21 wetland buffers established in the suburbs of Seattle, Washington. Each of the buffers, which ranged from two to eight years in age, were surveyed in the field. This were then compared to the original buffer plans submitted during development review. Despite the fact that they were relatively young, 95% of the buffers showed visible signs of alteration.

Forty percent of the buffers had been so altered by human activity that their capability to protect the adjacent wetland had been severely compromised. Buffer disturbances included tree removal, conversion into lawns, trampling and foot trails, filling, encroachment, dumping of yard wastes, and erosion by stormwater runoff (Table 2). Cooke found that narrow buffers

located on residential lots were particularly susceptible to alteration. In 100% of those sites the natural vegetation had been cleared and replaced by lawns (often grown with high fertilizer inputs). Buffer encroachment has also been noted in other regions of the country. One recent survey in Montgomery County, Maryland found that 10% of the total area of a stream valley park/buffer system has been lost due to encroachment in a single decade.

The clear implication from both studies is that local governments must do more than merely require buffers during development review. They must also make the effort to manage buffers after they become established. An objective should be to render them *visible* to contractors, users, and property owners who may try to encroach on them in the future. A series of planning, educational and enforcement tools for managing buffers are shown in Table 3. By incorporating some of these low cost tools into their programs, they can "buffer" their buffers, and help ensure that they are actually protected from human activities.

—TRS

#### References

- Heraty, M. 1993. *Riparian Buffer Programs: A Guide to Developing and Implementing a Riparian Buffer Program as an Urban Best Management Practice*. Prepared for U.S. EPA, Office of Wetlands, Oceans and Watersheds. 118 pp.
- Cooke, S.S. 1991. *Wetland Buffers—A Field Evaluation of Buffer Effectiveness in Puget Sound*. Washington Department of Ecology. 150 pp.

Welsch, D. 1991. *Riparian Forest Buffers—Function and Design for Protection and Enhancement of Water Resources*. USDA Forest Service. NA-PR-07-91. 28 pp.

**Table 2: Types of Disturbance to Urban Wetland Buffers in King and Snohomish Counties, Washington (N=21) (Cooke, 1991)**

Category Of Disturbance	Percent of Buffer Disturbed
Dumping of Yard Wastes	76
Conversion of Natural Vegetation into Lawn or Turf	100
Tree Removal	50
Evidence of Fertilizer Impact	55
Evidence of Stormwater Short-Circuiting Buffer	28
Increased Dominance of Invasive/Exotic Plants	67
Evidence that Buffer had been Maintained	5
Trails Established in Buffer	29
Buffers Exhibiting Signs of Alteration	95
Severely Altered Buffers (Not Protecting Adjacent Wetland)	43
Severe Encroachment or Fill	20

**Table 3: Techniques to Maintain the Integrity of Stream and Wetland Buffers**

#### Planning Stage

- Require buffer limits to be present on all clearing/grading and erosion control plans.
- Record all buffer boundaries on official maps.
- Clearly establish acceptable and unacceptable uses for the buffer.
- Establish clear vegetation targets and management rules for different lateral zones of the buffer.
- Provide incentives for owners to protect buffers through perpetual conservation easements rather than deed restrictions.

#### Construction Stage

- Pre-construction stakeout of buffers to define Limits of Disturbance (LOD).
- Set LOD based on drip-line of the forested buffer.
- Conduct pre-construction meeting to familiarize contractors and foremen with LOD and buffer limit.
- Mark the LOD with silt fence barrier, signs or other methods to exclude construction equipment.

#### Post-Development Stage

- Mark buffer boundaries with permanent signs (or fences) describing allowable uses.
- Educate property owners/homeowner associations on the purpose, limits and allowable uses of the buffer.
- Conduct periodic "bufferwalks" to inspect the condition of the buffer network (using volunteers, where possible).
- Reforest grass or lawn buffers.



## Techniques for Improving the Survivorship of Riparian Plantings

The Stroud Water Research Center has recently completed a long-term research project on the best techniques to establish native riparian forest buffers along streams in the Piedmont watersheds of Pennsylvania. Sweeney (1993) indicates that poor survival can be expected for planted seedlings, due to competition from weeds, drought, and animal predation. He stresses that weed control (twice annual mowing or careful application of herbicides) was the major factor influencing the survival rates of seedlings.

After 11 years in a test plot, 73% of seedlings survived where weed control had been practiced, as compared to a mere 7% where it had not. Most of the mortality occurred in the first three years after planting.

The use of tree shelters (four foot tall plastic tubes enclosing the seedling) was found to sharply increase the growth rate and survivorship of seedlings. For example, the height of red oak and black walnut were 1.6 and 2.4 times greater for the sheltered versus unsheltered seedlings. Sweeney suggested that the higher growth rate for these relatively slow growing species afforded by tree shelters may help ensure that these species are adequately represented in the final riparian forest canopy.

Tree shelters increased survivorship by 70 to 85% for tulip poplar, red oak, and black walnut but had little impact on white ash. The tree shelters were thought to reduce animal predation, weed competition, and reduce water loss due to wind. Tree shelters were demonstrated to increase drought tolerance, particularly at drier up-land sites.

Sweeney recommends several measures to improve the success rate in establishing riparian forest cover in the Northeastern U.S. (Figure 1). They include the following:

- Site preparation should focus on the mechanical removal of exotic species such as honeysuckle and multiflora rose, if they are present;
- Tree species should be selected to match local soil and moisture conditions;
- A mix of successional species (weed control, no shelters) and climax species (tree shelters) on a three meter spacing should be used.

Sweeney suggests that a riparian forest can become established within seven to 10 years using techniques such as these.

—TRS

### Reference

Sweeney, B.W. 1993. *Effects of Streamside Vegetation on Macroinvertebrate Communities of White Clay Creek in Eastern North America*. Proceedings of the Academy of Natural Sciences of Philadelphia. (144): 291-340.

Figure 1: Techniques to Improve Seedling Survival in Riparian Reforestation Projects (Sweeney, 1993)

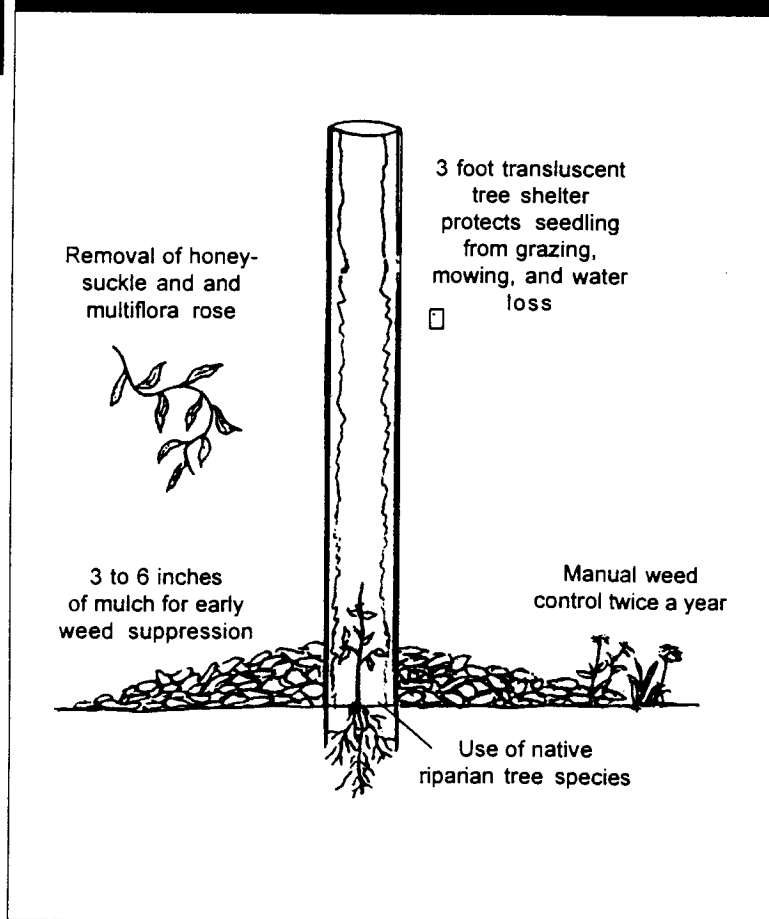



# Impact of Riparian Forest Cover on Mid-Atlantic Stream Ecosystems

**W**hat is the value of a forest buffer along small streams? Strong evidence about the critical role riparian forests play in stream ecosystems has emerged in a recent research study by Sweeney (1993). He compared the physical and ecological characteristics of headwater streams that had two different types of riparian cover: second growth forest and grassy meadows. The first and second order streams used in the study were located in the White Clay Creek watershed in the Piedmont of Pennsylvania.

Sweeney noted that the channels of headwater streams with forest cover were about 2.5 times wider than those with only grass cover. The "stream narrowing" associated with headwater streams without riparian forest cover was attributed to the formation and slumping of grass sod from the banks that gradually encroached into the channel. Thus, the channel gradually narrowed in width and became deeper.

Stream narrowing associated with the lack of riparian forests can have several serious ecological consequences. For example, 54% less surface area was present on the stream bottom to support the benthic habitat needed for aquatic organisms. In addition, forested streams had 7.5 times as much woody debris and 27 times as much total snag volume in their channels compared to streams without forest cover.

Woody debris and snags are extremely valuable habitat areas for many aquatic insects and help the stream retain more of its organic matter inputs. Sweeney found, for example, that 38 times more leaf litter and fine woody debris were present in forested streams, as compared to those with only grass or meadow cover. The greater retention of organic matter in forested streams is of critical significance because leaf litter serves as an important energy source in the aquatic food web.

The wider and shallower channels of forested streams had nearly 17 times more wetted rock area than the deeper and narrower meadow streams. While wetted rock area seems like a particularly obscure stream variable, it has a lot of meaning for aquatic insects. Submerged cobbles and rock surfaces are where they cling to avoid high water velocity. Exposed rocks, on the other hand, are sites where aquatic insects emerge to begin the aerial phase of their life cycle. Thus, the reduced wetted rock area in the narrower and deeper meadow streams results in poorer habitat for aquatic

insects.

Forest cover also shades the stream. For example, on sunny days, solar radiation inputs to the forested stream were reduced by 17% (summer) and 42% (winter), compared to meadow streams. Consequently, water temperatures in the forested streams were typically much cooler than meadow streams (an average of four degrees C).

Aquatic ecosystems in headwater streams without forested cover have reduced diversity and productivity. Sweeney notes major differences in the composition of the aquatic insect community between the two stream types. Notably, forested streams have "shredder" and "collector" feeding guilds while grassy meadow streams have "grazer" guilds. The major changes in stream habitat and temperature also affect individual species, each of which has its own tolerance limits for reproduction, emergence, larval development, and feeding environment.

Although Sweeney's study was conducted in a rural watershed, it has many implications for urban streams as well. Clearly, riparian forest cover is a key factor in maintaining the integrity of any headwater stream ecosystem. This finding suggests that efforts to preserve or reestablish riparian cover along urban streambanks should be a consistent element of a local stream protection approach. As a note, urban streams may well be widening and narrowing at the same time (due to the increased channel erosion from increased stormwater flows, and the encroachment by grass sod). Perhaps further research can shed light on the channel dynamics of urban headwater streams.

—TRS

## Reference

Sweeney, B.W. 1993. *Effects of Streamside Vegetation on Macroinvertebrate Communities of White Clay Creek in Eastern North America*. Proceedings of Academy of Natural Sciences of Philadelphia (144)-291-340.



R0079694

# The Return of the Beaver

**T**hey're back. Beavers were extirpated from many watersheds by the early 1900s due to heavy trapping pressures and habitat disturbance. Beaver populations, however, have soared in the past two decades in response to less trapping, fewer predators, and reintroduction efforts by state wildlife agencies.

Population statistics illuminate this remarkable recovery. By the early 1900s, the North American beaver population had dwindled to about 100,000. Since then, it has recovered to an estimated level of six to 20 million individuals. The recovery may not be fully complete. Some wildlife biologists estimate that some 60 to 400 million beavers were present in North America prior to the advent of the fur trade (Naiman *et al.*, 1986). During the recovery, beavers have expanded their range and returned to many watersheds where they had long been absent. Indeed, some wildlife biologists believe that due to relocation programs, the beaver currently has a greater range than before Europeans arrived on the continent (Clements, 1991).

This adaptable mammal can now be found across most of North America, and is a common sight in many urbanizing watersheds (Figure 1). It is no longer unusual to see beavers or their dams in such unlikely places as downtown Washington, D.C., suburban Detroit, or a new subdivision in Portland. Indeed, increased efforts to protect stream valleys, parks, creek buffers, greenways, wetlands, floodplains, riparian forests and other natural areas in urban watersheds also help to reserve prime beaver habitat.

While the return of the beaver is welcome, it has many implications for the urban watershed manager. First, the beaver is considered a "keystone species"

because it fundamentally influences the ecology of headwater streams and adjacent riparian areas. In natural areas, for example, researchers have found that beavers can directly alter up to 40% of the small streams and rivers in the landscape, and an impressive 15% of the forest cover (Hammerson, 1994; D'Eon *et al.*, 1995). Their activities increase the retention of sediment and organic matter. The network of dams and pools created by beavers also has a profound impact on the water quality and ecology of streams.

As a consequence, urban watershed managers are now faced with a series of questions about beavers after an absence of many generations. How will beavers alter the narrow belts of urban riparian forest? Will they play a positive or negative role in fishery habitat? In what manner will they change the water quality of urban streams?

On a more pragmatic level, the engineering works of the beaver often conflict with the plans of humans. Complaints about blocked culverts, flooding, inundation, and tree damage have sharply increased as beaver and human habitat overlap. What techniques can be applied to minimize beaver problems? Can a beaver problem ever be truly eliminated? Lastly, is it possible to reconcile the concerns of angry landowners, wildlife lovers and animal rights activists in an effective management plan?

In this article, we explore the implications of the return of the beaver, beginning with a review of its fascinating natural history and its impact on headwater streams. A range of management techniques for countering beaver problems are then assessed. In most cases, these techniques have had limited effectiveness, i.e., they can reduce beaver damages but seldom can

**Table 1: Beaver Biology and Life History**  
(Olson *et al.*, 1994)

Mating Behavior	Pair for Life
Size at Maturity	40-60 lbs
Territory	Approximately 1/2 square mile. Territorial marking with scent glands.
Living Arrangements	Family colonies
Dispersal	Leave to establish new territory within 5-10 miles at around age 2
Food Sources	Bark of trees and shrubs as well as softer vegetation
Litters	2-4 young per litter
Distribution	Not found in Arctic, arid Southwest, Florida, nor Atlantic Coastline

reduce beaver populations. As a result, watershed managers may need to educate residents on how to co-exist with this adaptive mammal.

### The Natural History of Beaver

The size of beavers makes them quite noticeable in an urban setting where large wildlife is often absent. In fact, beavers are the largest rodents in North America and can weigh as much as 60 pounds. The beaver's broad flat tail is used for both underwater maneuvering and to slap water to warn others of oncoming danger.

Like many rodents, beavers are quite fecund, reproducing at an average of three to four kits per litter. At two years of age, juvenile beaver leave the parental lodge just before the birth of a new litter, often migrating as far as five to 10 miles away. In some cases, tagged beavers have been recorded roaming as far as 100 miles to establish new territory.

The migration of the juvenile beavers is usually dictated by the availability of food and territory, and this dispersal is also known to be the leading cause of beaver mortality. New territories are established from May to July which coincides with the increased number of reported beaver problems.

Beavers chew trees for food and to provide themselves with the building materials for dams and lodges. Strictly vegetarian, the beaver diet consists of the bark from aspens, willows, alders, poplars, and birch trees, as well as softer aquatic vegetation such as sedges and grasses. Beavers must continually gnaw on trees, not only for food and building materials, but also to wear down their two huge front teeth.

Dam building is an instinctual reaction of beavers to the sight or sound of running water and provides the beavers a stable body of water, deep enough that it will not freeze to the bottom in winter (D'Eon *et al.*, 1995). Beaver dams also provide a handy conduit to transport downed trees.

The resulting pond from beaver dams also provides an effective refuge from predators. In larger streams and rivers where water fluctuations are not as drastic, beavers generally do not build dams.

### Beaver Influence on Stream and Riparian Ecology

The impact of a beaver pond on stream ecology is most strongly felt on second to fifth order streams, as shown in Table 2. Excellent reviews can be found in Hammerson (1994) and Olson and Hubert (1994), although it should be noted that nearly all the research has been drawn from rural and wilderness settings.

In general, a beaver pond tends to shift a stream from a running water ecosystem to more of a shallow lake environment. Locally, the beaver ponds trap sediments and organic matter, and increase algal productivity.

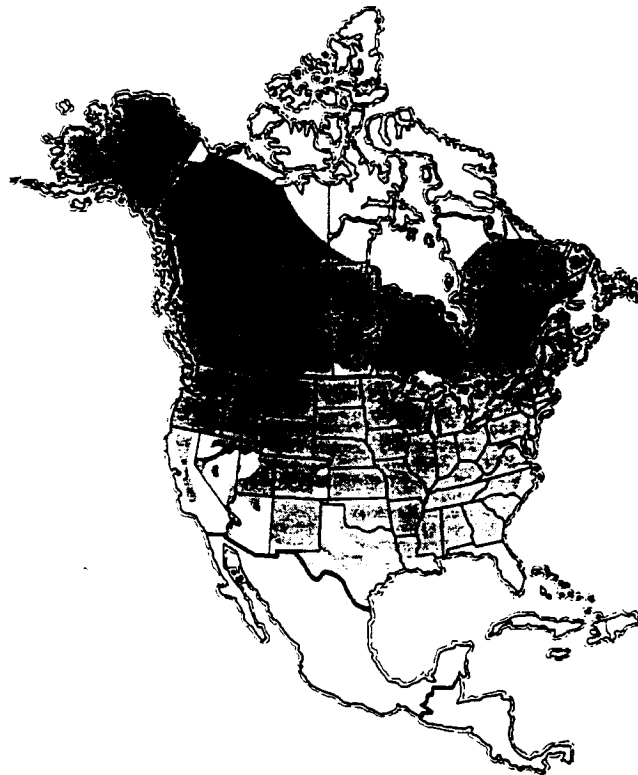

Figure 1: Distribution Map Showing Beaver Range in North America (Rue, 1981)

Beaver ponds help retain and store small floods, but the dams can washout during extreme floods and thereby increase downstream flood damage. The dams often raise the local water table, and create a greater connection with the floodplain. Beaver activity breaks the forest canopy, but the ponding water often kills other trees whose roots cannot tolerate inundation. These conditions, in turn, favor the growth of riparian tree species such as alders and willows, which are a preferred food source for the beaver. The patches, edges and dead standing trees can result in three-fold increase in songbird species (Medin and Cleary, 1990) and can dramatically enhance amphibian and mammal habitat as well (Olson and Hubert, 1994).

Beaver dams function very much like a stormwater pond, and exert a similar influence on downstream water quality. For example, Maret (1987) found that beaver pond complexes in one Wyoming stream sharply reduced total suspended solid concentrations, and reduced phosphorus and nitrogen by 20 to 50%. Beaver ponds are usually an effective buffer, and tend to increase the pH of water. At the same time, beaver ponds increase downstream water temperature which can adversely affect trout populations at lower elevations and latitudes. In addition, decomposition and



R0079696

**Table 2: Local or Downstream Changes Caused by Beaver Dams  
(Hammerson, 1994)**

1. Storage of precipitation, gradual release during dry weather
2. Reduced current velocity
3. Increase in wetted surface area of channel by several orders of magnitude
4. Increased water depth
5. Higher elevation of the local water table
6. Decrease in amount of forest canopy
7. Loss of habitat for species that depend on live deciduous trees
8. Enhanced or degraded fish habitat and fisheries
9. Creation of habitat for species that prefer ponds, edges, and dead trees
10. Shift of aquatic insect taxa within pond to collectors and predators, and away from shredders and scrapers
11. Increase in aquatic insect emergence, per unit length of "stream"
12. Increase in algal productivity
13. Increased trapping of sediment and decreased turbidity
14. Favorable conditions for willow and alder
15. Increased movement of carbon, nitrogen, and other nutrients into stream
16. Reduced stream acidity (i.e., higher pH)
17. Lower oxygen levels in the spring and early summer due to decomposition
18. Increased resistance to ecosystem perturbation

5

microbial action occurring within the beaver pond typically lowers the dissolved oxygen content downstream. The aquatic insect community often becomes less diverse both within and below beaver ponds, with running-water species being replaced by pond taxa (Smith *et al.*, 1991).

The effects of dams are not temporary. Even though the construction looks a little shoddy in comparison to a stormwater pond, a typical dam and lodge complex is maintained for about 10 years before it is typically abandoned (Hammerson, 1994). The beaver dams slow the flow of water, minimizing soil erosion and scouring. In some cases beaver dams help restore drought areas by raising the water table and creating lush meadows (Stuebner, 1994).

**Beaver Problems**

Beaver damage is not trivial. D'Eon *et al.* (1995) has estimated that beaver damage in North America exceeds 100 million dollars every year.

Beavers are fairly impressive loggers. It has been estimated that a single family of beavers can consume the equivalent of about an acre of dense trees each year (D'Eon *et al.*, 1995). This rate of consumption can have a major impact on any suburban stream buffer, landscape, park or open space. The impact is particularly acute in suburban areas since most forest areas consist of relatively small forest fragments.

Tree damage was only one of two frequently reported beaver problems from homeowners. A frustrated homeowner cited that the backyard of her residential area had become a wetland, attracting mosquitoes to the area. Beavers are also suspected of transmitting *Giardia*, a parasite that can be transplanted to humans by drinking water infested with it. One report even indicated a case of an attacking beaver in Fairfax County, Virginia. The beaver was accused of allegedly snapping at a woman's ankles and lurching at dogs.

But by far and away, the greatest damage associated with beavers is the ponding behind the dam, flooding when the dam is breached, or blockage of culverts. The 500 respondents in the North American beaver survey reported road flooding as the primary type of damage caused by beavers. Culvert blockage, damage to standing timber, and flooding of land were also rated highly by respondents (Table 3).

Like a stormwater engineer looking for an ideal retrofit site, beavers love road culverts. With relatively little work, the beaver can plug up the culvert, and quickly back water up to form a pond. The culvert can no longer convey runoff from large storm events, in-

**Table 3: Types & Percentages of Beaver Problems Reported  
(D'Eon *et al.*, 1995)**

Type of Damage	% of Repondents
Road Flooding/Damage	71%
Culvert Blockage/Damage	82%
Damage to Standing Timber	48%
Flooding of Land	57%

**Table 4: Beaver Management - Methods and Success Rates**  
(D'Eon *et al.* 1995)

	Always Successful	Sometimes Successful	Never Successful
Removal of Beavers by:			
Trapping	34%	65%	1%
Shooting	18%	78%	4%
Live-Trapping/Relocating	10%	62%	28%
Dam Destruction by:			
Explosives	22%	71%	7%
Manually	12%	69%	19%
Control Water Levels by:			
Barriers/Grills	5%	79%	16%
Syphons/Pipes	6%	82%	12%
Prevention by:			
Bridges vs. Culverts	12%	76%	12%
Oversized Culverts	4%	77%	19%
Road Design	6%	75%	18%

creasing the probability that the road will be flooded or the earthwork washed out.

#### Management Options

Wildlife biologists have employed kill-traps, live-traps, poison, guns, sterilization, electric fences, dynamite, drain pipes, fences and other contraptions to eliminate or discourage beavers. None of these methods, however, has proven to be completely effective, although some are clearly better than others. The North American Survey conducted by D'Eon *et al.* (1995) asked 500 beaver experts about their experience with these management techniques, and a condensed summary of the results are provided in Table 4. Some of the more effective methods are profiled below:

##### *Kill-Trapping*

The rules and regulations vary and consultation with your state wildlife agency is advisable before trapping. In some areas, licensed trappers are allowed to harvest if a nuisance becomes apparent and the problem is documented. Another advantage to trapping is that it is probably the cheapest management option. Many trappers are willing to do it for free if the price of pelts is high.

In addition, trapping was reported as the most frequently used method (94% of respondents) that had the highest effectiveness. Nearly all (99%) of respondents in the survey indicated it was sometimes or always effective (D'Eon *et al.*, 1995). One should keep in mind that since juvenile beavers disperse each year

to find prime sites, it is likely that a problem area will be recolonized frequently. Experts recommend that trapping be systematically done on an annual basis.

One additional issue to consider is that for every resident that wants to get rid of a beaver, there are many others that enjoy their presence or are ethically opposed to trapping. Thus, it is often difficult to obtain consensus to support a trapping program in many suburban communities.

##### *Live-Trapping*

While live-trapping and subsequent relocation of nuisance beavers is a more humane approach, this option is plagued with problems. One of its major flaws is that this approach requires considerable effort and cost. Additionally, beaver densities in many parts of the nation are already high. With acceptable habitats becoming saturated, few state wildlife agencies are willing to allow relocation.

As was the case with regular trapping, live-trapping must be performed repeatedly to solve the problem due to recolonization. A survey of the effectiveness of live-trapping found only 41% of beaver managers use the option, and only 10% rate it as "always successful" (D'Eon *et al.*, 1995).

##### *Tree Protection*

Individual trees can be effectively protected by placing a three-foot collar of hardware cloth or heavy wire mesh loosely around the base of the tree. A drawback of fencing is that it cannot prevent trees from



**R0079698**

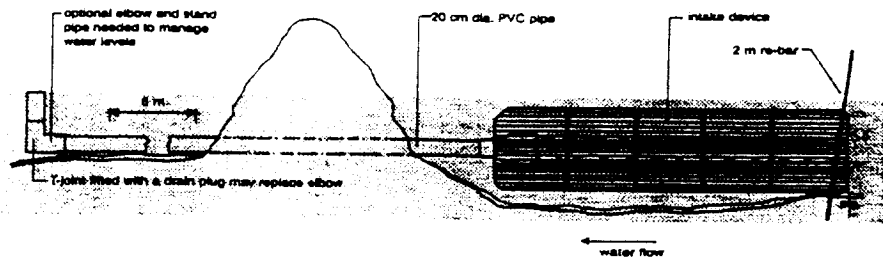

The Clemson Beaver Pond Levelers frustrate beavers by continually lowering the water level behind the dam. A key feature is the protective mesh near the intake that prevents beavers from plugging intakes.

Figure 2: Clemson Beaver Pond Leveler  
(D'Eon *et al.*, 1995)

dying due to rising water levels. Hammerson (1994) and D'Eon *et al.* (1995) report that deer repellents may also work in some conditions, but the odor may be objectionable for some landowners. This is probably the most effective strategy for the suburban homeowner that seeks to protect a landscaping investment, but is often too costly and impractical to do on a larger scale.

#### Water Level Control

The majority of beaver problems are created by rising water levels caused by the dam or plugging of a road culvert. The simple and cool approach of dynamiting the dam into smithereens seldom works, unless all beavers are trapped or removed. Beavers are quite industrious, and can repair the breach in a matter of days or weeks. The survey indicated only a modest success rate when dams were destroyed. Dynamite was found to be more effective than manual removal of beaver dams (Table 4).

An alternative approach is to drain the pond by installing a pipe under the dam (or through a clogged culvert). This approach is simple and can work fairly well if the intake is well protected. Otherwise, beavers will try to plug it up with mud and wood to restore water levels, so protective measures are essential. One reported incident involved an industrious beaver that outsmarted an engineer by plugging up every half-inch hole in a perforated pipe.

D'Eon *et al.* (1995) reviews a handful of pipe schemes to control water levels and the one of the most effective appears to be the Clemson Beaver Pond Leveler (see Figure 2). The idea behind the pond leveler is to keep the rise in water table at a minimum by using pipes to continually drain the pond. This simple mechanism requires the installation of 20 cm diameter PVC pipe through a dam with an attached multi-hole intake device guarded by fencing. This method requires little maintenance and is widely used. A step-by-step construction of another kind of pond leveler is listed in Table 5.

Table 5: Pond Leveler Assembly Instructions  
(Hammerson, 1994)

Step 1	Assemble perforated and unperforated PVC pipe, caps, steel fence posts.
Step 2	Inspect pond and dam to find the deepest and closest invert to the downstream channel for breachpoint.
Step 3	Breach the dam with two foot wide slot at breachpoint with fork.
Step 4	Extend perforated pipe into pond, connect to perforated pipe within the slot, connect to underwater flexible pipe within stream.
Step 5	Level PVC pipe to achieve positive drainage, secure to fence posts driven into pond and stream bottom.
Step 6	Allow beavers to repair the slot.
Step 7	Monthly inspection to clear any obstructions.

The Clemson pond leveier was tested at 50 beaver ponds in the southeastern United States and was never plugged by beavers. It is easy to fabricate and install, and costs less than \$400 per unit. It can be used for culvert protection as well. (The only down side may be frustrated beavers!).

#### *Other Management Methods*

Sterilization is a long-term management method and a more humane option. However, one should keep in mind that sterilization doesn't keep the beavers from chewing trees or creating water level problems. Sterilization can also be costly since most experiments have been done on individual beavers.

Although it may be too late in some cases, it is often wise to consider preventative planning measures. *The Beaver Handbook* also provides survey information on such practices. For example, almost 90% of respondents who built bridges rather than culverts reported high success levels. Again, cost may be a factor in selecting between options. Site selection, road design and larger culverts were also fairly effective, with success rates varying from 81 to 86%.

#### **Conclusion**

It looks like the beavers are here to stay. A realistic beaver management program should account for at least some beaver activity since you really can't keep the rodents from breeding. Consequently, population control is a necessity in all management programs. Harvesting and sterilization are two ways to control beaver populations. Tree protection and water level control devices should be employed along with population control methods.

Watershed management requirements should determine the appropriate choice between methods. Cost may also be an important factor. For example, fencing trees may be good for areas with a few trees, but this method would be too costly to utilize in a thick forest. Choosing the management option best suited to the beaver problem is essential for an effective program. As an example, the water control devices won't do any good if your beaver problem is tree loss.

Urban watershed managers should always consult state resource agencies on wildlife management laws. Most states have strict hunting regulations governing trapping and beaver dam demolition laws. Resources like *The Beaver Handbook* are also valuable sources of management guidance.

—HYK

#### **References**

- Clements, C. 1991. "Beavers and Riparian Ecosystems." *Rangelands* 13(6).
- D'Eon, R.G. *et al.* 1995. *The Beaver Handbook: A Guide to Understanding and Coping with Beaver Activity*. Northeast Science & Technology.
- Hammerson, G. 1994. "Beaver (*Castor canadensis*): Ecosystem Alterations, Management, and Monitoring." *Natural Areas Journal* 14(1):44-57.
- Maret, J.M., Parker, and Fanny, T. 1987. "The Effect of Beaver Ponds on the Nonpoint Source Quality of a Stream in Southwestern Wyoming." *Water Resources* 21(3):263-268.
- Medin, D., and W. Cleary. 1990. *Bird Populations in and Adjacent to a Beaver Pond Ecosystem and Adjacent Riparian Habitat in Idaho*. Intermountain Forest and Range Experiment Station. USDA Forest Service. Ogden, UT.
- Naiman, R., J. Melello and J. Hobbie. 1986. "Ecosystem Alteration of Boreal Forest Streams by Beaver. (*Castor canadensis*)." *Ecology* 67:1254-1269.
- Olson, R., and W.A. Hubert. 1994. *Beaver: Water Resources and Riparian Habitat Manager*. University of Wyoming. Laramie, WY. 48 pp.
- Rue, L. 1981. *Furbearing Animals of North America*. Crown Publishers. New York, NY. 336 pp.
- Smith, B. *et al.* 1991. "Modification of Stream Ecosystem Structure and Function by Beaver." *Canadian Journal of Zoology* 69:55-61.
- Stuebner, S. 1994. "Bullish on Beaver." *National Wildlife*. April-May. Vienna, Virginia.



R0079700

5

R0079701



# Section 6: Better Site Design

## Watershed Protection Tool #4

New development can be designed to greatly reduce its impact on watersheds, when careful efforts are made to reduce impervious cover, conserve natural areas, and better integrate stormwater treatment. These practices, collectively known as better site design, are reviewed in detail in article 45. Better site design can be applied to both residential subdivisions (article 46) or commercial developments (article 47). Recent research profiled in these articles documents the impressive reductions in impervious cover, runoff, pollutant loadings and development costs that better site design can attain when compared to traditional developments. However, despite its great promise, better site design is not a widely used watershed protection tool. Indeed, many communities practice rather poor site design, at least from a watershed perspective. Their own development rules mandate wide streets, long driveways, expansive parking lots and large-lot subdivisions that create needless impervious cover and crowd out natural areas and open space.

The management of impervious cover is at the heart of the practice of watershed protection. Given that more than 1.5 million acres of land are developed each year in the United States, it is critical that these each new development in the watershed creates the smallest possible amount of impervious cover and conserves the largest possible amount of natural areas and open space.

While the concepts of better site design have been around for decades, they have not been widely implemented for two basic reasons. First, the many different elements of better site design were never organized into a comprehensive package that was specifically targeted for watershed protection. Second, many communities still have development rules that work against better site design, and in fact, often create needless impervious cover. These local development rules are an often bewildering mix of subdivision codes, zoning regulations, parking and street standards and other local regulations that collectively shape how development happens in a community. The complexity and inflexibility of these rules make it difficult or even impossible to practice better site design. Developers find that innovative developments cannot be approved in some communities, or find that they require a greater investment of time, money and perseverance in others. As communities struggle to protect watersheds, they soon realize that they must manage impervious cover, and they find that this cannot be done until they systematically reform the local development rules that are responsible for creating it.

### *Trends in Better Site Design in the Last Decade*

Several recent initiatives are making it easier to implement better site design at the local level. The first was a landmark agreement on a series of better site design principles by a diverse coalition of development interests

that was adopted in 1997. This rare alliance, which included bankers, road engineers, fire chiefs, homebuilders, and watershed advocates among its members, concluded that better site design made both economic and environmental sense. In addition, the coalition examined the impediments and barriers to practicing better site design, and dispelled many of the corresponding myths and misconceptions. Perhaps the greatest benefit of the agreement, however, was that it established a national benchmark against which communities could compare their own local development rules. A small but growing number of communities are now beginning to review and reform their development rules in a process known as a local site planning roundtable, which is detailed in article 48. Early results from these communities are very en-

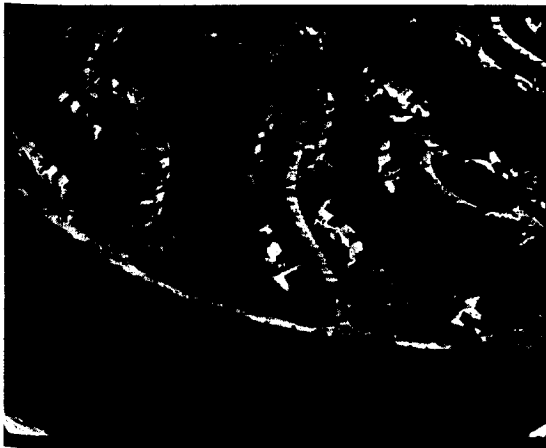

"The management of impervious cover is at the heart of watershed protection"

couraging, and hold forth the promise that better site design will be the rule, rather than the exception, in the decade to come. A good source to start learning about better site design is the Center's handbook, *Better Site Design: Changing Development Rules in Your Community*.

#### *Research Needs for Better Site Design*

Much of the research needed to demonstrate the economic and environmental benefits of better site design has already been conducted, and the major focus at this time is on the tedious but important job of local implementation through some sort of local roundtable process. Still, a few research gaps need to be filled. First, more intensive research is needed to precisely define the real-world parking demand for a wide range of retail, office and other uses in order to confidently establish ideal minimum parking lot sizes. Second, there are still many unknowns in regard to the performance, longevity and cost of alternative pavers, and further experiments and demonstration projects are warranted. Third, it would be useful to monitor the comparative runoff and pollutant loads of residential subdivisions that are designed in the traditional manner versus those using better site design practices. Lastly, it is important to emphasize that the better site design principles are not always applicable to many redevelopment and infill situations, or for highly urban watersheds in general. Planners will need to adapt and reinterpret better site design practices to address the different challenges, constraints, and competing interests that are routinely encountered in these high-density areas.

### **Better Site Design Contents**

45.	An Introduction to Better Site Design .....	253
46.	The Benefits of Better Site Design in Residential Subdivisions .....	263
47.	The Benefits of Better Site Design in Commercial Development .....	277
48.	Changing Development Rules in Your Community .....	287
49.	The Economics of Urban Sprawl .....	290
50.	Skinny Streets and One-Sided Sidewalks: A Strategy for Not Paving Paradise .....	296
51.	Use of Open Space Design to Protect Watersheds .....	299

**R0079703**

## An Introduction to Better Site Design

Few watershed management practices simultaneously reduce pollutant loads, conserve natural areas, save money, and increase property values. Indeed, if such “wonder practices” were ever developed, they would certainly spread quickly across the nation. As it turns out, these practices have existed for years. Collectively called “better site design,” the techniques employ a variety of methods to reduce total paved area, distribute and diffuse stormwater, and conserve natural habitats. Despite their proven benefits and successful local application, better site design techniques often fail to earn the endorsement of local communities. In fact, many communities simply prohibit their use.

“Better site design” is a fundamentally different approach to residential and commercial development. It seeks to accomplish three goals at every development site: to reduce the amount of impervious cover, to increase natural lands set aside for conservation, and to use pervious areas for more effective stormwater treatment. To meet these goals, designers must scrutinize every aspect of a site plan—its streets, parking spaces, setbacks, lot sizes, driveways, and sidewalks—to see if any of these elements can be reduced in scale. At the same time, creative grading and drainage techniques reduce stormwater runoff and encourage more infiltration.

Why is it so difficult to implement better site design in so many communities? The primary reason is the outdated development rules that collectively govern the development process: a bewildering mix of subdivision codes, zoning regulations, parking and street standards, and drainage regulations that often work at cross-purposes with better site design. Few developers are willing to take risks to bend these rules with site plans that may take years to approve or that may never be approved at all.

In 1997, a national site planning roundtable was convened to address ways to encourage better site design techniques in more communities. The participants represented the diverse mix of organizations that affect the development process (listed in Table 1) and provided the technical and real world experience to make better site design happen. After two years of discussion, the roundtable endorsed 22 better site design techniques that offer specific guidance that can help achieve the basic better site

design goals. These techniques are organized into three areas:

1. Residential Streets and Parking Lots
2. Lot Development
3. Conservation of Natural Areas

These techniques are not intended to be strict guidelines, and their actual application should be based on local conditions. The remainder of this article introduces each of the better site design techniques, describes some of the barriers to their wider use, and suggests ways to overcome these impediments.

### Residential Streets and Parking Lots

As much as 65% of the total impervious cover in the landscape can be classified as “habitat for cars,” which includes streets, parking lots, driveways, and other surfaces designed for the car. Consequently, 10 better site design techniques address ways to reduce car habitat in new developments.



**Figure 1: A Neotraditional Community in Gaithersburg, MD**  
Better site design techniques have been successfully applied in a growing number of communities like the Kentlands.

**Table 1: Organizations Represented at the National Site Planning Roundtable (CWP, 1998b)**

The following organizations participated in a two-year long process to craft and refine the 22 model development principles. For a full look at the national consensus agreement, consult our web site at [www.cwp.org](http://www.cwp.org).

American Association of State Highway Transportation Officials	Land Trust Alliance
American Forest Association	Linowes & Blocher
American Institute of Architects	Loiederman Associates, Inc.
American Planning Association	Michael T. Rose Company
American Public Works Association	Montgomery County Council
American Rivers	Natelli Communities
American Society of Civil Engineers	National Association of Home Builders
American Society of Landscape Architects	National Realty Committee
Chesapeake Bay Program	Natural Resources Defense Council
Community Associations Inc.	Prince Georges County
The Conservation Fund	Department of Environmental Resources
Office of Comprehensive Planning, County of Fairfax, VA	U.S. EPA
Howard Research and Development Corporation an affiliate of the Rouse Company	Office of Sustainable Ecosystems and Communities
Institute of Transportation Engineers	U.S. Fire Administration
International City/ County Management Association	Urban Land Institute
	Urban Wildlife Resources

*Design residential streets for the minimum required pavement width needed to support travel lanes, on-street parking, and emergency, maintenance, and service vehicle access. Street widths should be based on traffic volume.*

In some communities, residential streets can be 32, 36, and even 40 feet wide, despite the fact that they only serve a few dozen homes. These wide streets are the greatest source of impervious cover in most subdivisions. Wide residential streets are created by blanket applications of high volume and high speed design criteria, the perception that on-street parking is needed on both sides of the street, and the perception that they provide unobstructed access for emergency vehicles.

Communities have a significant opportunity to reduce impervious cover by revising their street standards to widths of smaller residential access streets. Residential streets widths should be designed to handle expected traffic volumes, provide adequate parking, and ensure access for service, maintenance, and emergency vehicles. Two strategies can help to narrow streets: using queuing streets (see Figure 2) and critically evaluating the need for on-street parking on both sides of the street. Several national engineering organizations have recommended residential streets as narrow as 22 feet in width (ASSHTO, 1994 and ASCE, 1990).

*Reduce the total length of residential streets by examining alternative street layouts to determine the best option for increasing the number of homes per unit length.*

Conventional Street

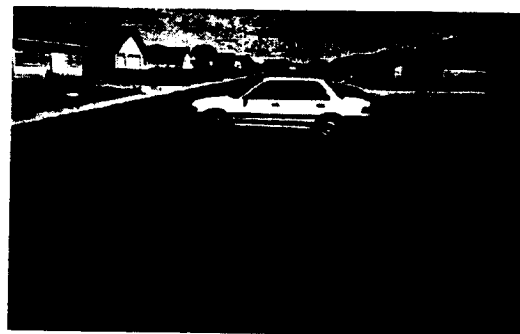

Queuing Street



(photos by Randall Arendt)

**Figure 2: Queuing Streets as a Technique for Minimizing Street Width**

While traditional streets are composed of two travel lanes and parking on either side of the road, queuing streets have one designated travel lane and two queuing lanes that can be used for travel or parking.

It stands to reason that a longer street network produces more impervious cover and greater development costs than a shorter one, yet most communities do not even consider whether a shorter street network can serve individual lots on residential streets. It is generally assumed that the cost of constructing roads is sufficient incentive to assure short street networks. Streets are designed to accommodate rapid, smooth traffic flow, and consequently, total street length is rarely the most important design consideration.

There is no one street layout guaranteed to minimize total street length in residential developments. Instead, site designers are encouraged to analyze different layouts to see if they can reduce street length.

*Wherever possible, residential street right-of-way widths should reflect the minimum required to accommodate the travel-way, the sidewalk, and vegetated open channels. Utilities and storm drains should be located within the pavement section of the right-of-way wherever feasible.*

In many communities, a single right-of-way width of 50 feet or more is applied to all residential street categories. While a wide right-of-way does not necessarily create more impervious cover, it requires more clearing and consumes land that could be used to achieve a more compact site design. By redesigning each of the main components of the right-of-way (ROW), the total width of the ROW can be sharply reduced. Techniques include reducing street width, narrowing sidewalks or restricting them to one side, narrowing the distance between street and sidewalk, and installing utilities beneath street pavement. Combined, these techniques narrow the ROW by 10 to 25 feet.

*Minimize the number of residential street cul-de-sacs and incorporate landscaped areas to reduce their impervious cover. The radius of cul-de-sacs should be the minimum required to accommodate emergency and maintenance vehicles. Alternative turnarounds should be considered.*

Many communities require the end of cul-de-sacs to be 50 to 60 feet in radius, creating large circles of needless impervious cover. There are several different options to reduce the impervious cover created by traditional cul-de-sacs. One option is to reduce the radius of the turnaround bulb. Several communities have implemented this successfully and the smaller radii can range from 33 to 45 feet. Since vehicles only use the outside of a cul-de-sac when turning, a second option is to create a pervious island in the middle of

the cul-de-sac, creating a donut-like effect. A third option is to replace cul-de-sacs with loop roads and hammerheads (see Figure 3).

*Where density, topography, soils, and slope permit, vegetated open channels should be used in the street right-of-way to convey and treat stormwater runoff.*

Communities often require that curbs and gutters be installed along residential streets, which quickly convey stormwater runoff and associated pollutant loads directly into the stream. In contrast, open channels can remove pollutants by infiltration and filtering, and are also often less expensive than curb and gutter systems.

New engineering techniques have greatly improved the performance of conventional roadside ditches, which have traditionally suffered from erosion, standing water and increased pavement maintenance. One alternative is dry swales, which are designed both to convey the 10 year storm and treat a water quality stream through a sandy loam filter along the roadway (see Figure 4).

*The required parking ratio governing a particular land use or activity should be enforced as both a maximum and a minimum in order to curb excess parking space construction. Existing parking ratios should be reviewed for conformance, taking into account local and national experience to see if lower ratios are warranted and feasible.*

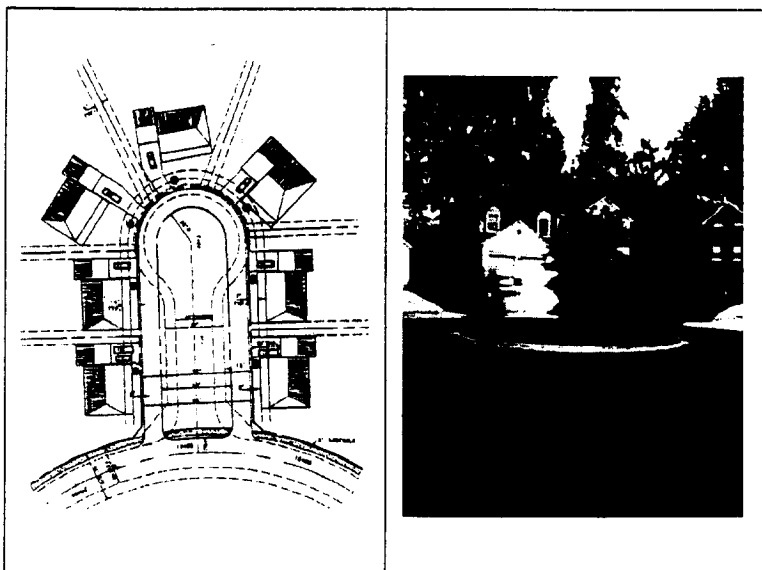

**Figure 3: Two Alternatives to the Traditional Cul-de-Sac**  
A loop road or a pervious island in the middle are two alternatives that can significantly reduce impervious cover.



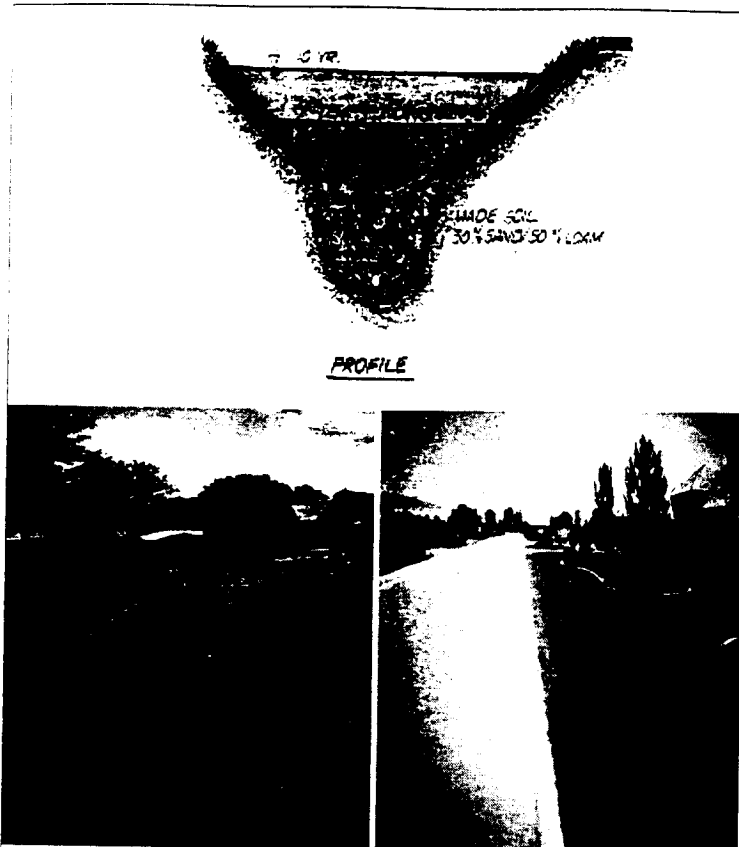

**Figure 4: Profile and Two Examples of Open Vegetated Channels**

Open vegetated channels allow for infiltration and treatment of stormwater on-site. A dry swale is typically designed to convey the 10 year storm, while treating smaller events with a subsurface composed of a sand and loam filler that treats the runoff before it enters a stream.

*Parking codes should be revised to lower parking requirements where mass transit is available or enforceable shared parking arrangements are made.*

Despite the fact that parking lot size can shrink dramatically if credits for shared parking or mass transit are provided, only a handful of communities require or encourage developers to use these tools. Shared parking allows adjacent land uses to share parking lots if peak parking demands occur during different times of the week. Mass transit can reduce the number of vehicle trips, which translates directly into smaller parking lots.

Despite challenges, several communities have successfully provided parking credits for shared parking and reducing the total number of parking spaces created. One such example is Oakland, California, where a thorough study of short and long term parking demand was conducted. By taking an inventory of existing land uses, parking, and occupancy; and by considering vacancy factors, mass transit access, low auto ownership, and operations of special use facilities, the study concluded that parking rate for office space could be reduced from three spaces to 1.44 spaces per 1,000 gross square feet (ITE, 1995).

*Reduce the overall imperviousness associated with parking lots by providing compact car spaces, minimizing stall dimensions, incorporating efficient parking lanes, and using pervious materials in the spillover parking areas where possible.*

Reducing the size of parking stall dimensions represents another opportunity to reduce impervious cover. The length and often the width of a typical parking stall can often be reduced by a foot or more. Parking codes can also be amended to require a fixed percentage of smaller stalls for compact cars. Lastly, while permeable parking surfaces can be more expensive to install and maintain, the use of these materials in the 10 to 20% of the lot that will be used for spillover parking can reduce stormwater treatment costs.

Many communities routinely build more parking spaces than are needed to meet actual parking demands. This is a result of using outdated or overly generous local parking codes to determine minimum parking ratios.

Communities should check their local codes to ensure that both a minimum and a maximum number of parking spaces are set for each building project (see Table 2 for recommended maximum parking spaces). By referring to national, regional and/or local studies, communities can evaluate their parking needs more accurately, thereby reducing the creation of unnecessary parking spaces. Even small reductions in parking can reduce construction and stormwater management costs. As it turns out, shrinking parking lots is critical in reducing the impact of commercial development (see article 46).

**Table 2: Recommended Parking Demand Ratios for Selected Land Uses (CWP, 1998b)**

Land Use	Better Site Design Parking Ratios
Single Family Homes	2 spaces or less per dwelling unit*
Professional Offices	3.0 spaces or less per 1000 ft <sup>2</sup>
Retail	4.0 to 4.5 spaces or less per 1000 ft <sup>2</sup>
* can be accommodated in driveway	

*Provide meaningful incentives to encourage structured and shared parking to make it more economically viable.*

The type of parking facility in a development site is usually determined by the cost of land balanced against the cost of constructing parking. In suburban and rural areas, the low cost of land makes surface parking more cost-effective than building a garage. In highly urban areas, garages may be a more economical option, since land costs are at a premium.

Vertical parking structures can significantly reduce impervious cover by reducing acreage converted to parking. However, given the economics of surface parking versus garages, it is unlikely that garages will become the norm without incentives. Incentives for defraying some of the costs of parking garages could include tax credits, stormwater waivers or bonuses for density, floor area or building height. A simple way to save on the cost of garages is to incorporate them below or on the first floor of buildings, thereby reducing the structural cost for parking.

*Wherever possible, provide stormwater treatment for parking lot runoff using bioretention areas, filter strips, and/or other practices that can be integrated into required landscaping areas and traffic islands.*

Although parking lots are a significant source of stormwater pollution, many communities do not require developers to provide stormwater quality control. In other communities, opportunities to minimize and treat stormwater runoff at the parking lot are often overlooked. Parking lots can be made more attractive at the same time they treat stormwater. Bioretention areas, dry swales, perimeter sand filters, and filter strips are all effective at treating stormwater within the parking lot. Figure 5 provides a schematic diagram and example of a bioretention facility.

### Lot Development

Many opportunities exist to reduce impervious cover in residential developments by modifying the shape, size, and layout of residential lots. Perhaps the greatest opportunity is to shift from conventional subdivisions to open space or cluster subdivisions.

*Advocate open space design subdivisions incorporating smaller lot sizes to minimize total impervious area, reduce total construction costs, conserve natural areas, provide community recreational space, and promote watershed protection.*

Open space subdivisions cluster houses into a smaller portion of the development site, leaving more of the site as natural open space. Figure 6 illustrates the

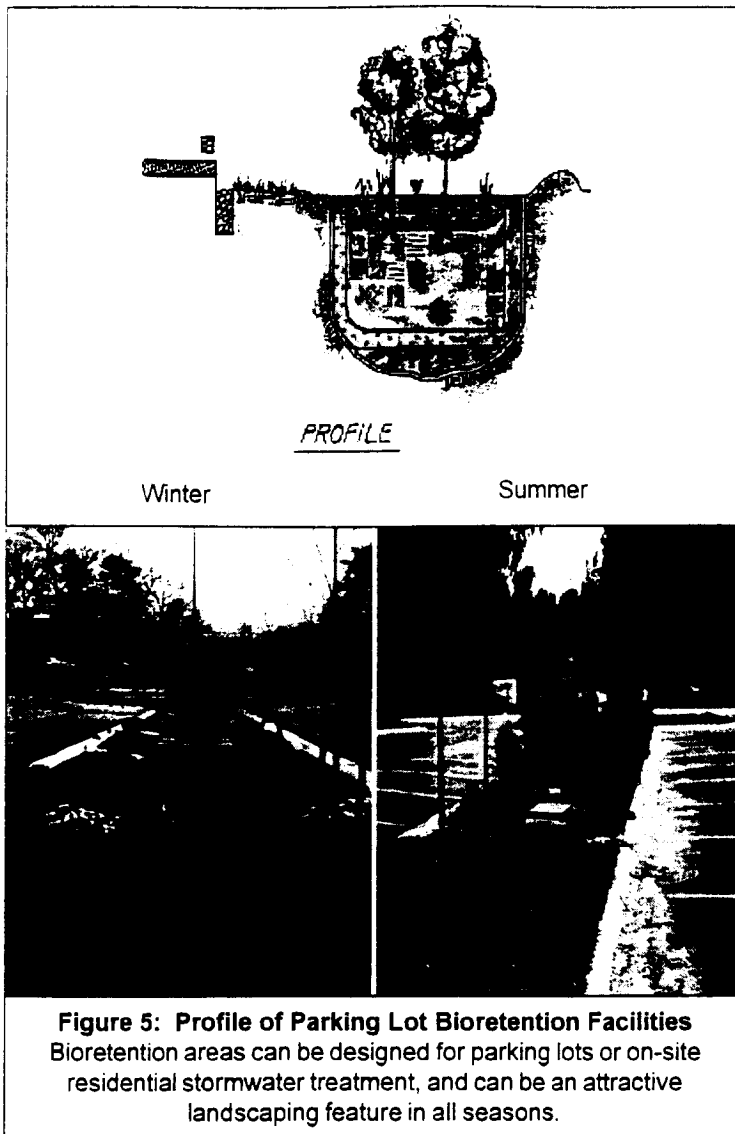

**Figure 5: Profile of Parking Lot Bioretention Facilities**  
Bioretention areas can be designed for parking lots or on-site residential stormwater treatment, and can be an attractive landscaping feature in all seasons.

differences between a conventional and an open space subdivision. Open space subdivisions have been documented to reduce impervious cover, stormwater runoff, and construction costs (see the second feature article in this issue for more details). While open space subdivisions are not always feasible in dense residential zones (more than six dwelling units per acre), communities that can utilize this technique should consider making open space subdivisions a by-right development option.

Although open space subdivisions (also known as cluster design) have been advocated by planners for many years, they are often prohibited or severely restricted by local zoning regulations. In 95% of communities surveyed by Heraty (1992), clustering is a voluntary, rather than a mandatory, development option. In addition, open space subdivisions often require a special exception or zoning variance (i.e. they are not a by-

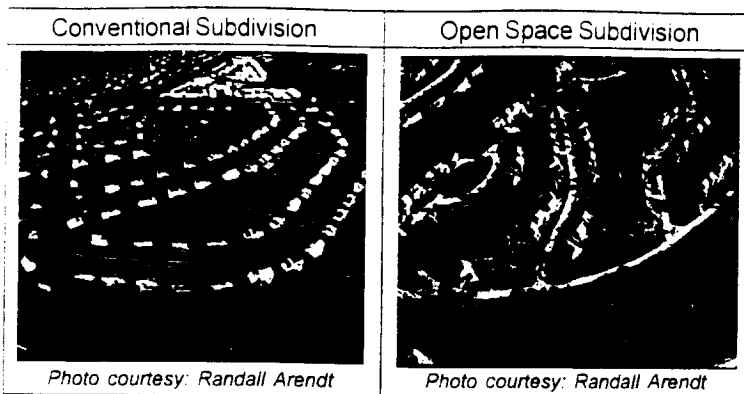

**Figure 6: Examples of Conventional and Open Space Site Designs**

Many conventional developments are designed using a cookie-cutter approach. Open space site designs preserve more of the existing vegetation and reduce the amount of land that is cleared and graded for individual lots.

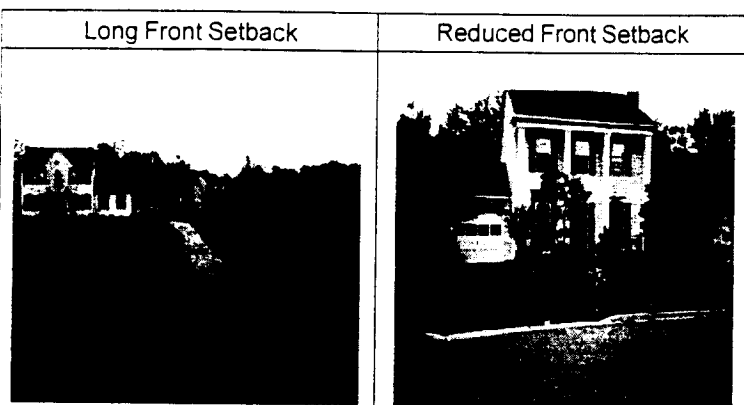

**Figure 7: Examples of Long and Reduced Front Setbacks**  
Smaller front setbacks can reduce site impervious cover, but many current subdivision codes have strict requirements that govern

right form of development) which requires more review time. Consequently, open space designs are not always widely exercised by developers.

*Relax side yard setbacks and allow narrower frontages to reduce total road length in the community and overall site imperviousness. Relax front setback requirements to minimize driveway lengths and reduce overall lot imperviousness.*

Many current subdivision codes have very strict requirements that govern lot geometry, including setbacks and lot shape. These criteria constrain site planners from designing open space or cluster developments that can reduce impervious cover. Smaller front and side setbacks, often essential for open space designs, are typically not allowed or require a zoning variance that may be difficult to obtain.

Relaxing setback requirements allows developers to create attractive, compact lots that are marketable and livable (see Figure 7). For example, side yard setbacks can be as close as five feet from detached housing without specific fire protection measures. Often, fears about fire safety, noise, parking capacity and sight distance impairment are cited as impediments to shorter setbacks, but the reality is that these concerns can be overcome with careful design.

*Promote more flexible design standards for residential subdivision sidewalks. Where practical, consider locating sidewalks on only one side of the street and providing common walkways linking pedestrian areas.*

Most subdivision codes require sidewalks on both sides of residential streets, constructed of impervious concrete or asphalt, four to six feet wide, and two to 10 feet from the street. While these codes are intended to promote pedestrian safety, sidewalks should not be designed so rigidly. Instead, the general goal should be to improve pedestrian movement by diverting it away from street traffic. Often, a sidewalk on one side of the street is sufficient. In fact, in a study of pedestrian accidents associated with sidewalks, there was a negligible difference in accident rates when sidewalks were reported on just one side of the street versus sidewalks on both sides of the street (NHI, 1996).

Communities should also consider reducing the sidewalk width of sidewalks to three to four feet and placing them further from the street. Sidewalk design should emphasize the connections between neighborhoods, schools, and shops, instead of merely following the road layout (Figure 8). In addition, sidewalks should be graded to drain to front yards rather than the street. These alternatives reduce impervious cover and provide practical, safe, and attractive travel paths.

*Reduce overall lot imperviousness by promoting alternative driveway surfaces and shared driveways that connect two or more homes together.*

Most local subdivision codes are not very explicit as to how driveways should be designed. Most simply require a standard apron to connect the street to the driveway but do not specify width or surface material for driveways. Typical residential driveways are 12 feet wide for one car driveways and 20 feet wide for two. Shared driveways are discouraged or prohibited by many communities.

Shared driveways can reduce impervious cover, and can work when maintenance agreements and easements can be enforced. By specifying narrower driveways, promoting permeable paving materials, and allowing two-track driveways or gravel and grass



surfaces. communities can sharply reduce the typical 400 to 800 square feet of impervious cover created by each driveway (see Figure 9).

*Clearly specify how community open space will be managed and designate a sustainable legal entity responsible for managing both natural and recreational open space.*

Open space subdivisions encourage the preservation of common areas that must be effectively managed. Surveys of local open space regulations, however, revealed that open space was poorly defined in most communities (Heraty, 1992). Less than a third required that open space be consolidated. Only 10% required that a portion of open space be maintained as natural cover, and few specified which uses were allowed or excluded in the open space areas. Some communities are wary of open space because they feel that community associations may lack financial, legal, or technical resources to effectively maintain their common areas.

In reality, open space maintained in a natural condition costs up to five times less to maintain than lawns. Communities should explore more reliable methods to ensure that responsibility is taken for open space management. Effective methods include creating a community association, or shifting responsibility to a land trust or park through a conservation easement.

*Direct rooftop runoff to pervious areas such as yards, open channels, or vegetated areas and avoid routing rooftop runoff to the roadway and the stormwater conveyance system.*

Often, local codes discourage the storage and treatment of rooftop runoff on individual lots, thus bypassing opportunities to promote filtering or infiltration in the front or back yard. Most subdivision codes require that yards have a minimum slope to ensure drainage away from homes. The slope helps move runoff away from the home to prevent nuisance ponding, basement flooding, or ice formation on driveways or sidewalks. However, these concerns are only significant within 10 or 15 feet from the home foundation.

Sending rooftop runoff over a pervious surface before it reaches an impervious one can decrease the annual runoff volume from residential development sites by as much as 50%. Techniques to treat rooftop runoff in the yard include directing flow into small bioretention areas that encourage sheet flow across vegetated areas (see Figure 10) or infiltrate runoff in trenches, dry wells, or french drains.

## Conservation of Natural Areas

Conservation of natural areas is integral to better site design, and the last six techniques deal with conserving and managing natural areas at the development site. These techniques include stream buffers, clearing and grading, tree conservation and stormwater treatment. To fully utilize these techniques, communities may need to offer developers both flexibility and incentives.

*Create a variable width, naturally vegetated buffer system along all perennial streams that also encompasses critical environmental features such as the 100-year floodplain, steep slopes and freshwater wetlands.*

This technique establishes a three-zone buffer system to protect streams, shorelines and wetlands at the development site (Figure 11). These three zones are distinguished by the types of allowable uses unique to each zone. In addition, the buffer should incorporate the 100-year floodplain, steep slopes, and freshwater wetlands to fully protect the water quality of streams, help treat stormwater, and enhance the quality of life for residents (Schueler, 1995).



**Figure 8: Using Flexible Design Standards for Sidewalks**  
Creating sensible pathways can produce safe, pedestrian friendly communities.



**Figure 9: Examples of Different Types of Shared Driveways**  
Shared driveways can help reduce the amount of impervious cover created for parking.



**Figure 10: Alternative Runoff Management**  
Two alternatives for managing rooftop runoff are bioretention areas and rain barrels.

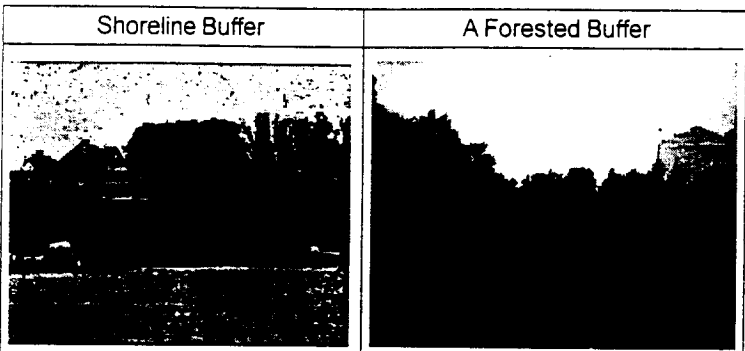

**Figure 11: Development vs. Buffer**  
A buffer is more than a setback from the stream or shoreline. Native vegetation cover should be retained within part of the buffer to protect the water quality, treat stormwater, and enhance natural beauty.

Buffers are noted for their economic benefits as well, including increased property values, reduced flood damages, and sediment removal costs savings. A model stream buffer ordinance and regional samples can be downloaded from our website at [www.cwp.org](http://www.cwp.org).

*The riparian stream buffer should be preserved or restored with native vegetation. The buffer system should be maintained through the plan review delineation, construction, and post-development stages.*

While establishing a buffer is paramount to better site design, assuring that the forest buffer is safeguarded from clear cutting is just as essential. Many communities have stream buffer ordinances, but a line drawn on a map is virtually invisible to contractors and landowners. Few communities require that buffer lines be marked. A strong buffer ordinance should outline the legal rights and responsibilities for management and maintenance during construction and for the long term. An effective buffer program should also indicate who is

responsible for these issues and address measures to reestablish buffers using native vegetation. Figure 12 illustrates two techniques for preserving and maintaining natural areas and buffers.

*Clearing and grading of forests and native vegetation at a site should be limited to the minimum amount needed to build lots, allow access, and provide fire protection. A fixed portion of any community open space should be managed as protected green space in a consolidated manner.*

Most communities allow the entire development site to be cleared and graded, with a few exceptions in specially regulated areas such as jurisdictional wetlands, steep slopes, and floodplains. Since areas that are conserved in their natural state retain their natural hydrology and are not exposed to erosion during construction, it is desirable to conserve as much original soil at the site as possible. Clearing should be limited to the minimum area required for building footprints, construction access, and safety setbacks. Existing tools that could be adapted to limit clearing include erosion and sediment control ordinances, grading ordinances, forest conservation or tree protection ordinances, and open space development. One study has shown that providing grassed lots can add \$750 to the value of a lot as compared to bare lots (Harbor and Herzog, 1999). For more information on clearing and grading, see articles 36, 37, 53 and 54.

*Conserve trees and other vegetation at each site by planting additional vegetation, clustering tree areas, and conserving native vegetation. Wherever practical, incorporate trees into community open space, street rights-of-way, parking lot islands, and other landscaped areas.*

Few communities require that a percentage of trees and native vegetation be conserved during the development process. In fact, many communities promote the use of lawns instead of native vegetation. However, native trees, shrubs, and grasses contribute to the quality of the environment, create a sense of place, and increase property values. Tools that can be used for tree conservation include adopting forest conservation ordinances, encouraging open space design, planting street trees in the rights-of-way, adopting clearing and grading restrictions to preserve trees and native vegetation, and adding landscaping requirements for parking lots.

R0079711

*Incentives and flexibility should be encouraged to promote conservation of stream buffers, forests, meadows, and other areas of environmental value. In addition, off-site mitigation should be encouraged where it is consistent with locally adopted watershed plans.*

A small number of communities require conservation of non-regulated areas such as stream buffers, forests, and meadows. Even fewer provide meaningful incentives for developers to conserve more natural areas than they are required to. To combat this problem, communities may want to offer increased flexibility and incentives to reward developers for conserving natural areas.

Methods to encourage conservation include by-right open space development, buffer flexibility, property tax credits, density bonuses, transferrable development rights, and providing credits for reduced stormwater management requirements. Stormwater credits exist for natural area conservation, disconnecting rooftop runoff, and routing sheetflow to buffers (MDE, 2000).

***New stormwater outfalls should not discharge unmanaged stormwater into jurisdictional wetlands, sole-source aquifers, or sensitive areas.***

Stormwater runoff generated from impervious cover can represent a significant threat to the quality of wetlands, surface water and groundwater. While many communities are beginning to require stormwater quality practices, they are often poorly matched to site conditions and watershed objectives.

Stormwater practices can be designed to be effective, attractive and relatively easy to maintain. A well-designed stormwater practice should add value to a community while meeting stormwater management objectives. For new criteria on the design of stormwater practices, refer to the *Maryland Stormwater Manual* available online: <http://www.mde.state.md.us/environment/wma/>

**Summary**

For many communities, implementing better site design may require that development rules be changed, and this process is not an easy one. Advocates of better site design are likely to have to answer some difficult questions from fire chiefs, lawyers, traffic engineers, developers, and many others in the community. Will a proposed change make it more difficult to park? Lengthen response times for emergency vehicles? Increase risks to community residents and children? Progress toward better site design will require more local governments to examine their current practices in the context of a broad range of concerns, such as how the changes

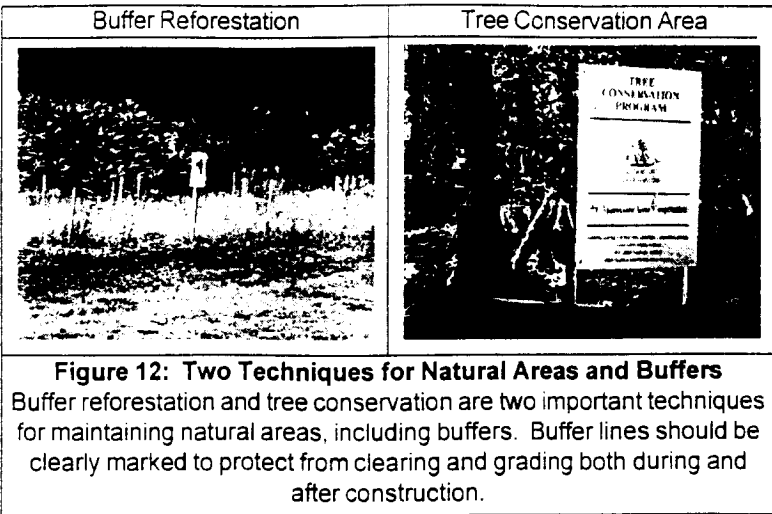

will affect development costs, local liability, property values, public safety, and a host of other factors.

Better site design has considerable potential to reduce the environmental impacts of new development sites, and when adapted properly, of redevelopment sites as well. Better site design is a particularly useful strategy in watersheds where future development is projected to approach or slightly exceed impervious cover thresholds. It should be kept in mind, however, that better site design alone cannot adequately protect most watersheds. It must be combined and integrated with other watershed protection tools, such as watershed planning, land conservation, erosion and sediment control and the rest. These caveats notwithstanding, better site design is the one of the few watershed protection tools that simultaneously provides dividends for watershed advocates, developers and the community as a whole. Consequently, communities are encouraged to invest in the local site planning roundtable process that can make it happen. **-HYK**



**R0079712**

## References

- American Association of State Highway and Transportation Officials (AASHTO). 1994. *A Policy on Geometric Design of Highways and Streets*. AASHTO, Washington, DC. No. 33.
- American Society of Civil Engineers (ASCE). 1990. *Residential Streets*, 2<sup>nd</sup> edition. Coauthors: National Association of Home Builders and Urban Land Institute. Published by the Urban Land Institute, Washington, D.C.
- Center for Watershed Protection (CWP). 1998a. *A Consensus Agreement on Model Development Principles*. Ellicott City, MD.
- Center for Watershed Protection (CWP). 1998b. *Better Site Design: A Handbook for Changing Development Rules in Your Community*. Ellicott City, MD.
- Harbor, Jon and Herzog, Martha. 1999. *Green Subdivision Lots Put Green in Developers' Pockets*. Earth and Atmospheric Sciences, Purdue University. West Lafayette, IN.
- Heraty, Maureen. 1992. *An Assessment of the Applicability of Cluster Development Regulations as a Nonpoint Source Pollution Best Management Practice*. Metropolitan Washington Council of Governments. Produced for U.S. EPA Office of Wetlands, Oceans and Watersheds. Washington, D.C.
- Institute of Transportation Engineers (ITE). 1995. *Shared Parking Guidelines*. Institute of Transportation Engineers. Washington D.C.
- Maryland Department of Environment (MDE). 2000. *Maryland Stormwater Design Manual*, Vol. 1. Center for Watershed Protection. Baltimore, MD.
- National Highway Institute (NHI). 1996. *Pedestrian and Bicycle Safety and Accommodations*. U.S. Department of Transportation, Federal Highway Administration, National Highway Traffic Safety Administration, McLean, VA. Publication #HWA-HI96-029. NHI Course No. 38061.
- Schueler, Thomas, R. 1995. *Site Planning for Urban Stream Protection*. Center for Watershed Protection, Ellicott City, MD. Prepared for the Metropolitan Washington Council of Governments, Washington, D.C.

# The Benefits of Better Site Design in Residential Subdivisions

**T**hough they may not realize it, site planners have an excellent opportunity to reduce storm water runoff and pollutant export simply by changing the way they lay out new residential subdivisions. Planners that employ open space design techniques can collectively reduce the amount of impervious cover, increase the amount of natural land conserved, and improve the performance of stormwater treatment practices at new residential developments.

Simply put, open space designs concentrate density on one portion of a site in order to conserve open space elsewhere by relaxing lot sizes, frontages, road sections, and other subdivision geometry. While site designs that employ these techniques go by many different names, such as clustering or conservation design, they all incorporate some or all of the following better site design techniques:

- Using narrower, shorter streets and rights-of-way
- Applying smaller lots and setbacks and narrow frontages to preserve significant open space
- Reducing the amount of site area devoted to residential lawns
- Spreading stormwater runoff over pervious surfaces
- Using open channels rather than curb and gutters
- Protecting stream buffers
- Enhancing the performance of septic systems, when applicable

In this article, we examine some of the benefits of employing better site design techniques as they apply to residential subdivisions. The analysis utilizes a simple spreadsheet computer model to compare actual residential sites constructed in the 1990s using conventional design techniques with the same sites "re-designed" utilizing better site design techniques. For each development scenario, site characteristics such as total impervious and vegetative cover, infrastructure quantities, and type of stormwater management practice are estimated.

The Simplified Urban Nutrient Output Model (SUNOM) was used to perform a comparative analysis for two subdivisions. The first is a large-lot subdivision known as Duck Crossing, and the second is a medium-density subdivision known as Stonehill Estates. In

each case, the model was used to simulate five different development scenarios:

- Pre-developed conditions
- Conventional design without stormwater practices
- Conventional design with stormwater practices
- Open space design without stormwater practices
- Open space design with stormwater practices

This article compares the hydrology, nutrient export, and development cost for these sites under both conventional and open space design, and with and without stormwater treatment. The article also summarizes other research on the benefits of open space design and discusses the implications it can have for the watershed manager.

**R0079714**

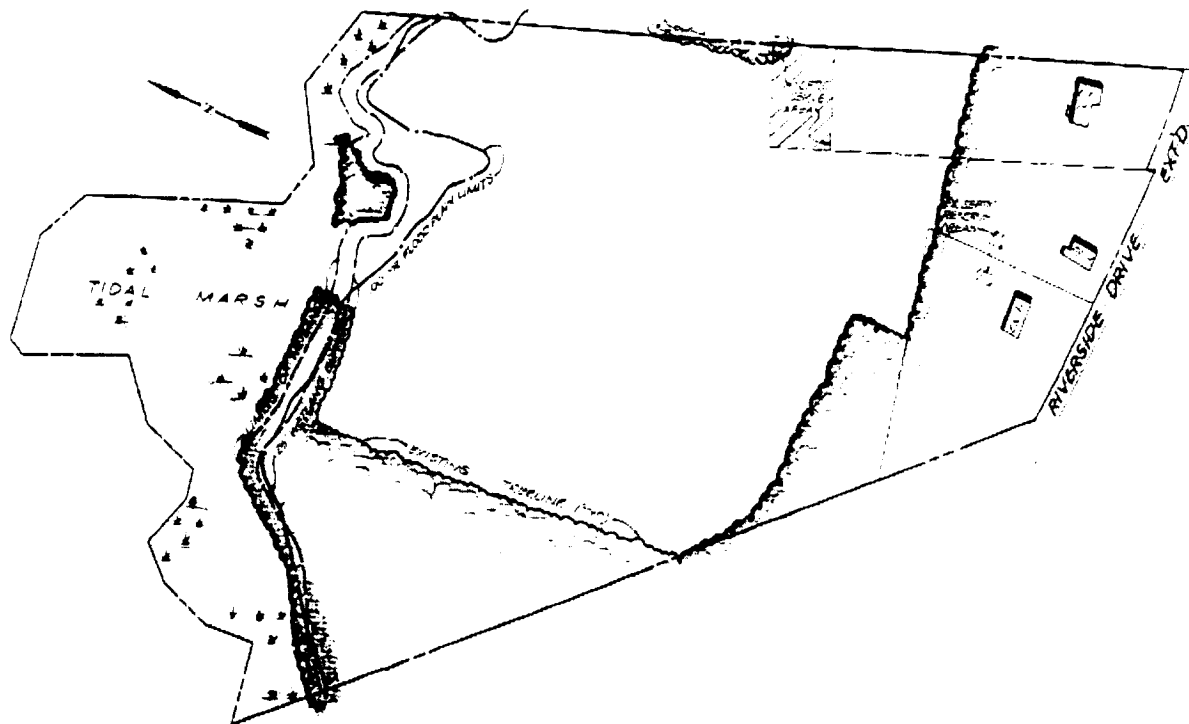

Figure 1: Predevelopment Conditions at the Duck Crossing Site

**Duck Crossing - A Low-Density Residential Subdivision**

Duck Crossing is a large-lot residential development located in Wicomico County on Maryland's Eastern Shore. Prior to development, the low gradient coastal plain site contained a mix of tidal and non-tidal wetlands, natural forest, and meadow (Figure 1). Its sandy soils were highly permeable (hydrologic soil group A). Three existing homes were located on the parcel, which relied on septic systems for on-site sewage disposal. The existing septic systems discharged a considerable nutrient load to shallow groundwater.

A conventional large-lot subdivision of eight single family homes was constructed on the 24-acre site in the early 1990s. The subdivision is reasonably typical of rural residential development along the Chesapeake Bay waterfront during this era (Figure 2). Each new lot ranged from three to five acres in size, and was set back several hundred feet from an access road. The access road was 30 feet wide and terminated in a large diameter cul-de-sac. Sidewalks were located on both sides of the street. Each lot was served by a conventional septic system with a primary and reserve field of about 10,000 square feet. Stormwater management consisted of curb and gutters that conveyed runoff into a storm drain system that, in turn, discharged to a small dry pond (designed for the water quality volume, only).

The entire site was privately owned, with the exception of the tidal marsh, which was protected under state and federal wetland laws and represented the only common open space on the site. As a result of construction, the existing meadow was entirely converted to lawn, and the impervious cover for the site increased to slightly over 8%.

*Open Space Design for Duck Crossing*

The critical ingredient of the open space redesign was a reduction in lot size from several acres to about 30,000 square feet. This enabled about 74% of the site to be protected and managed as common open space, which included most of the existing forest, wetlands and meadow (Figure 3). Consequently, only 19% of the site was managed as turf, nearly all of which was located on the private lots.

The open space redesign at Duck Crossing also incorporated a narrower access road (20 feet wide) along with shorter, shared driveways that served six of the eight lots. The road turnaround was designed as a loop rather than a cul-de-sac bulb. Also, a wood chip trail system was provided through the open space instead of sidewalks along the road. Each home site was carefully located away from sensitive natural areas and the 100-year flood plain. Taken together, these better site design techniques reduced impervious cover for

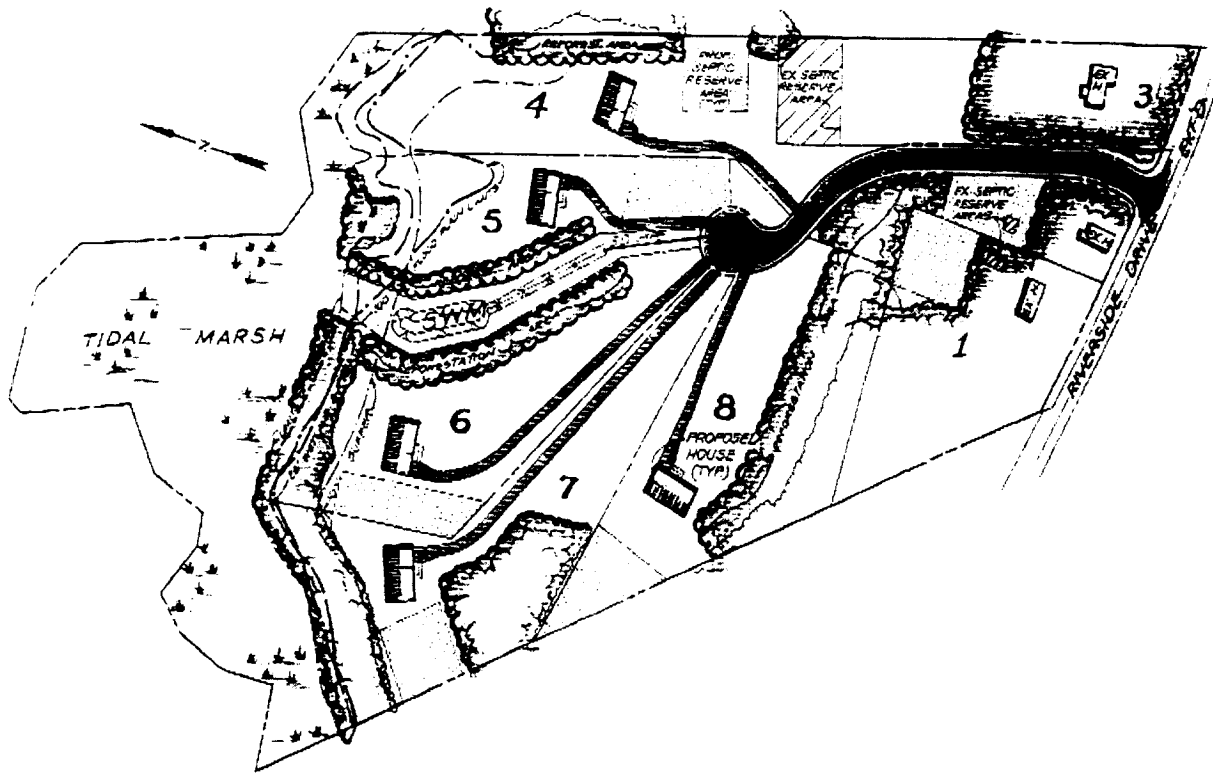

Figure 2: The Low-Density Conventional Subdivision Built at Duck Crossing (eight lots)

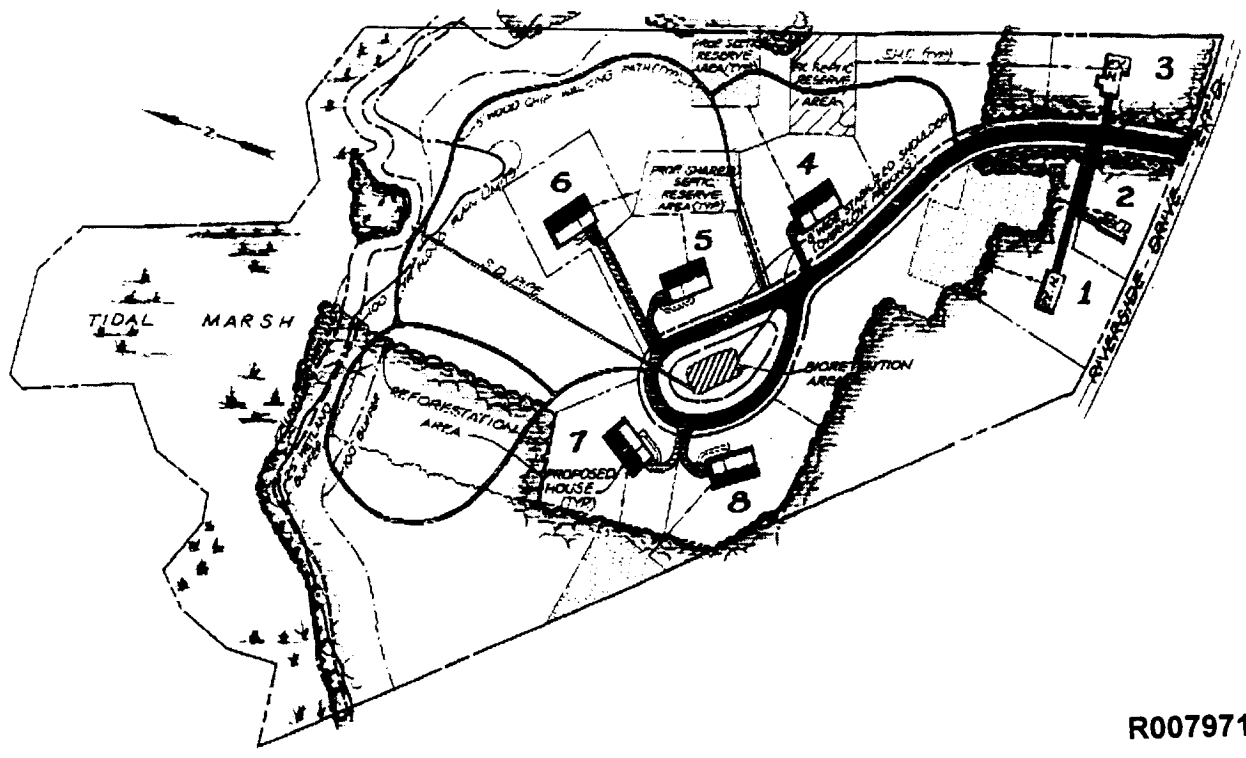

Figure 3: The Open Space Subdivision That Could Have Been Built at Duck Crossing (eight lots)

6

R0079716

the site by about a third compared to the conventional design (from 8% to 5%).

The redesigned stormwater conveyance system utilized dry swales rather than a curb and gutter system, and featured the use of bioretention areas in the roadway loop to treat stormwater quality. This combination of stormwater practices provided greater pollutant removal through filtering and infiltration.

One of the most important objectives in the redesign strategy was to improve the location and performance of the septic systems that dispose of wastewater at the site. Home sites were oriented to be near soils that were most suitable for septic system treatment. In addition, six homes shared three common septic fields located within open space rather than on individual private lots. Lastly, given the permeability of the soils, advanced re-circulating sand filters were installed to provide better nutrient removal than could be achieved by conventional septic systems.

#### Comparative Hydrology for Duck Crossing

Given its low impervious cover and permeable soils, the water balance at Duck Crossing was dominated by infiltration, even after development. The comparative hydrology under the five development scenarios is presented in Table 1. As might be expected, the conventional design yielded the greatest volume of surface runoff and the least amount of infiltration. The open space design produced about 25% less annual surface runoff and 12% more infiltration than the conventional design, but did not come close to replicating pre-development conditions. The use of stormwater practices did not materially change the water balance under either the conventional or open space design at Duck Crossing (see Table 1).

#### Comparative Nutrient Output at Duck Crossing

Nutrient export at Duck Crossing was dominated more by subsurface water movement than by surface runoff. Indeed, stormwater runoff seldom comprised more than 15% of the annual nitrogen or phosphorus load from this lightly developed site. The SUNOM model indicated that the major source of nutrients was subsurface discharges from septic systems, which typically accounted

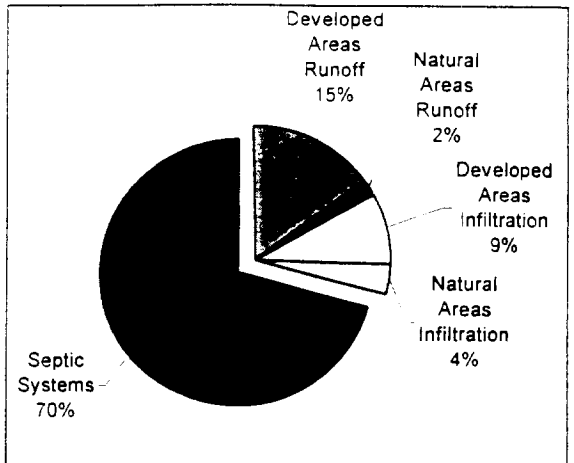

**Figure 4: Nitrogen Load Distribution From the Conventional Design of Duck Crossing, Without Stormwater Practices**

for 60 to 80% of the total load in every development scenario (see Figure 4).

The open space design sharply reduced nutrient export, primarily because re-circulating sand filters were used in the shared septic systems and helped to reduce (but not eliminate) subsurface nutrient discharge. The other elements of the open space design (reduced impervious cover, reduced lawn cover, and multiple stormwater practices) also helped to reduce nutrient export, but by a much smaller amount. The comparative nutrient export from each Duck Crossing development scenario is detailed in Figure 5.

#### Comparative Cost of Development

The cost to build infrastructure for the open space design was estimated to be 25% less than the conventional design at Duck Crossing, due primarily to the necessity for less road paving, sidewalks, and curbs and gutters. Even when higher costs were factored in for the more sophisticated stormwater and on-site wastewater treatment used in the open space design, the total cost was still 12% lower than the conventional design. In addition, the open space design had seven fewer

**Table 1: Annual Water Budget of Duck Crossing**

		Pre-Developed	Conventional Design	Open Space Design
Runoff (inches/year)	no practice	2.3	4.8	3.9
	practices	--	4.8	3.7
Infiltration (inches/year)	no practice	18.2	15.3	17.0
	practices	--	15.3	17.2



acres that needed to be cleared and graded, or served by erosion and sediment controls, compared to the conventional design (these costs are not currently evaluated by the SUNOM model). Overall, the SUNOM model estimated that the conventional design at Duck Crossing had a total infrastructure cost of \$143,600, compared to \$126,400 for the open space design.

**Summary**

The comparative results for the Duck Crossing redesign analysis are summarized in Figure 6. The open space design increased natural area conservation and reduced impervious cover, stormwater runoff, nutrient export, and infrastructure costs compared to the conventional subdivision design.

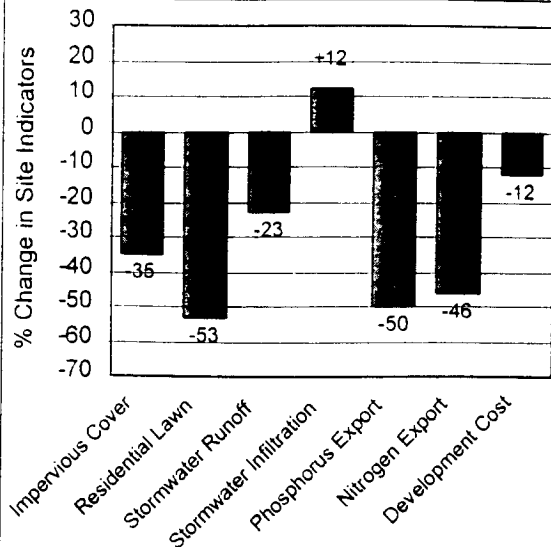

**Figure 6: Percentage Change in Key Site Conditions From a Conventional Design to an Open Space Design, Both With Stormwater Practices**

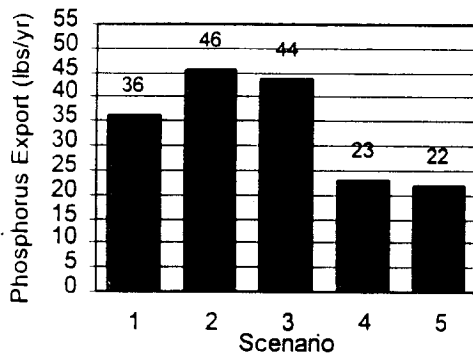
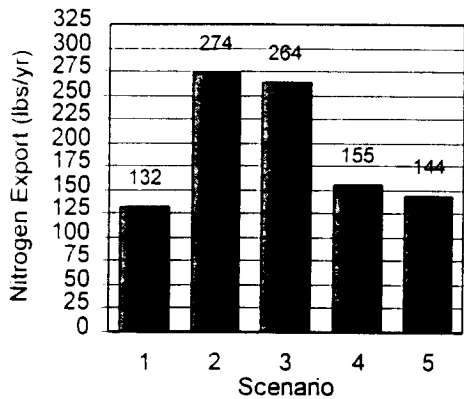

- 1 - Pre-Developed Conditions
- 2 - Conventional Design (no practices)
- 3 - Conventional Design (with practices)
- 4 - Open Space Design (no practices)
- 5 - Open Space Design (with practices)

**Figure 5: Annual Nitrogen and Phosphorus Loads for Each Development Scenario at Duck Crossing**



R0079718

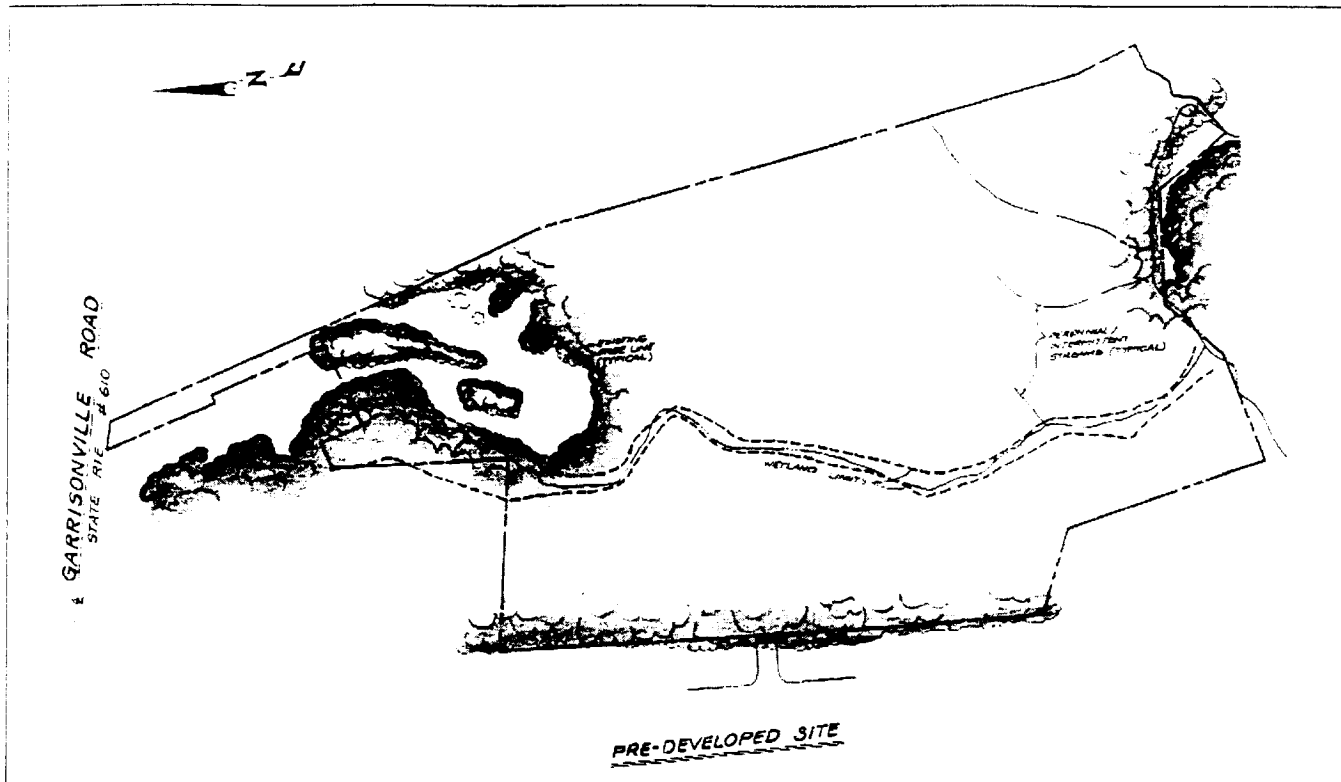

Figure 7: Predevelopment Conditions at the Stonehill Estates Site

**Stonehill Estates - A Medium-Density Residential Subdivision**

Stonehill Estates, located near Fredericksburg, Virginia, is situated in the rolling terrain of the Piedmont. The undeveloped parcel was 45 acres in size, nearly all of which was mature hardwood forest (Figure 7). An intermittent stream bisected the site, discharging into a perennial stream near the southern edge of the parcel. Roughly 3.6 acres of forested wetlands were found along the stream corridors, and an extensive floodplain was located along the perennial stream. Soils at the site were primarily silt loams and were moderately permeable (hydrologic soil groups C and D).

The site was highly attractive for development, given the excellent access provided by two existing roads, both of which had public water and sewer lines that could be easily tapped to serve the new subdivision. The conventional design was zoned for three dwelling units per acre. After unbuildable lands were excluded, the parcel yielded a total of 108 house lots, each of which was about 9,000 square feet in size (Figure 8). The subdivision design typifies medium-density residential subdivisions developed in the last two decades in the Mid-Atlantic region, where lots sizes were uniform in size and shape and homes were set back a generous and fixed distance from the street. The design utilized a mix of wide and moderate street sections (34 feet and 26 feet), and included six large

diameter cul-de-sacs for turnarounds. Sidewalks were generally installed on both sides of the street.

The stormwater management system for the conventional design represents the typical “pipe and pond” approach utilized in many medium-density residential subdivisions. Street runoff was conveyed by curbs and gutters into a storm drain system that discharged into the intermittent stream channel, and then traveled downstream to a dry extended detention pond. The pond was primarily designed to control flooding, but also provided some limited removal of stormwater pollutants.

Interestingly, about 25% of the site was reserved as open space in the conventional design at Stonehill Estates. Nearly all of these lands were unbuildable because of environmental and site constraints (e.g., floodplains, steep slopes, wetlands, and stormwater facilities), and the resulting open space was highly fragmented. Even so, about a fourth of the forested wetlands were impacted by two roads crossing over the intermittent stream. Almost 90% of the original forest cover was cleared as a result of the conventional design, and was replaced by lawns and impervious cover. Overall, about 60% of the site was converted to lawns, and another 27% was converted to impervious cover.

R0079719

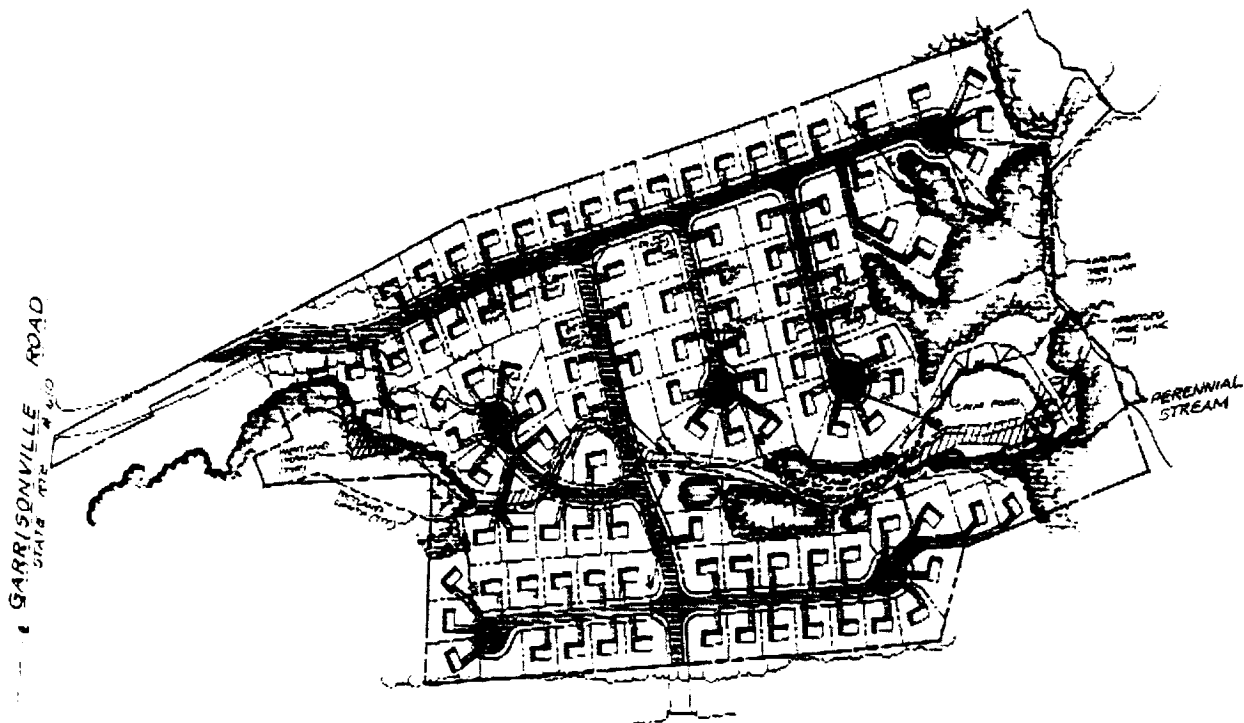

Figure 8: The Conventional Subdivision Design That Was Built at Stonehill Estates (108 lots)

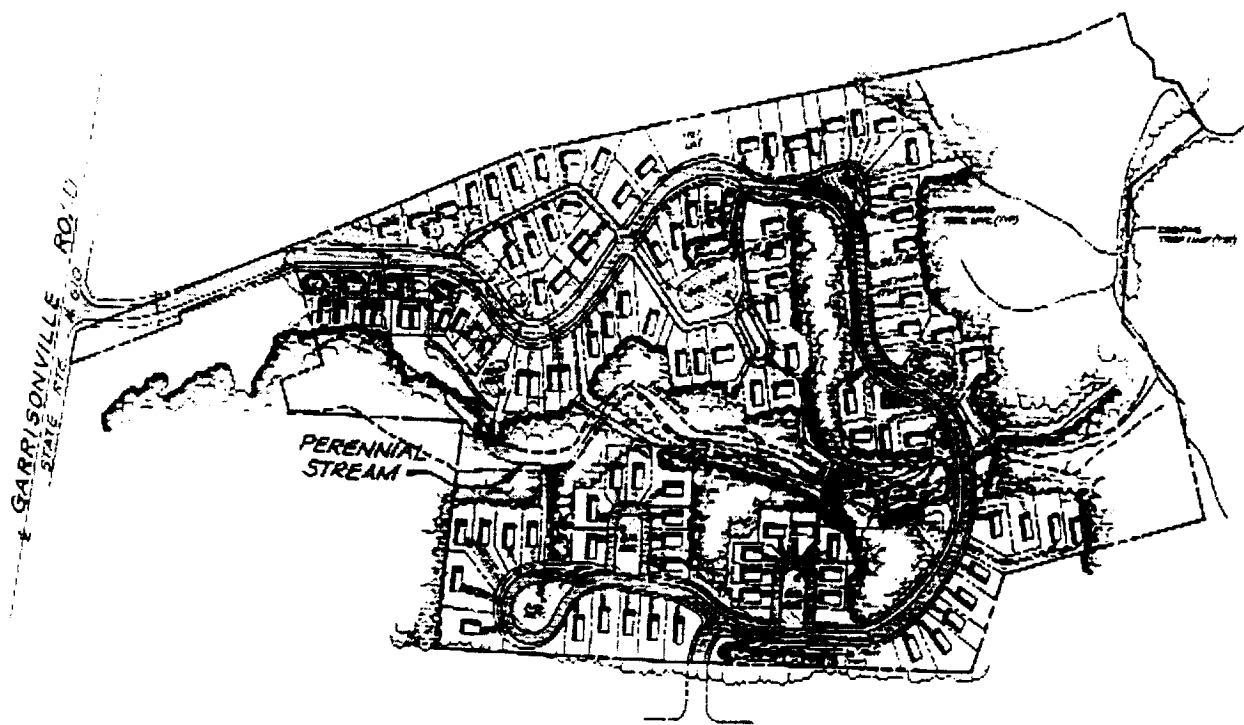

Figure 9: The Open Space Subdivision That Could Have Been Built at Stonehill Estates (108 lots)

6

*Open Space Design for Stonehill Estates*

In the redesign analysis, Stonehill Estates was designed to incorporate many of the open space design techniques advocated by Arendt (1994). The resulting design retained the same number of lots as the conventional design, but had a much different layout (Figure 9).

The average lot size declined from about 9,000 square feet in the conventional design to 6,300 square feet in the open space design. This reduced lot size allowed about 44% of the site to be protected as open space, most of which was managed as a single unit that included an extensive natural buffer along the perennial and intermittent stream corridor.

The basic open space layout was augmented by several other better site design practices, including narrower streets, shorter driveways, and fewer sidewalks. Loop roads were used as an alternative to cul-de-sacs. In some portions of the site, irregularly shaped lots and shared driveways were used to reduce overall road length. Each individual lot was located adjacent to open space, so that the more compact open space lots would not feel as crowded. As a result of these techniques, the open space design for Stonehill Estates reduced impervious cover from 27% to 20%. In addition, lawn cover declined from 60% to 30% of the total site area.

The innovative stormwater collection system utilized dry swales rather than storm drains in gently sloping portions of the site. The dry swales and several bioretention areas located in loop turnarounds were used to initially treat stormwater quality. Each of these practices then discharged to a small micro-pool detention pond, whose embankment was created by the single road crossing over the intermittent stream.

*Comparative Hydrology*

Prior to its development, the highly wooded site produced very little surface runoff, but because of relatively tight soils, generated only a modest amount of infiltration. However, after the site was converted into the conventional subdivision, surface runoff increased by a factor of five, and infiltration was reduced by about 40% (Table 2). In contrast, the open space design worked to reduce stormwater runoff and increase stormwater infiltration compared to the conventional design, although it did not come close to replicating the original hydrology of the forested site (Table 2).

*Comparative Nutrient Output*

As might be expected, the conversion of the forest into a conventional subdivision greatly increased nutrient export from the site; the model indicated that annual phosphorus and nitrogen export would increase by a factor of seven and nine, respectively, after development (see Figure 10). Unlike Duck Crossing, nutrient export at Stonehill Estates was dominated by stormwater runoff after development. The SUNOM model indicated that stormwater runoff contributed about 94% of the annual nutrient export from the site, with subsurface water movement adding only 6% to the total export. Nutrient loads were not greatly reduced by the dry extended detention pond installed at the conventional subdivision; the model indicated that nutrient

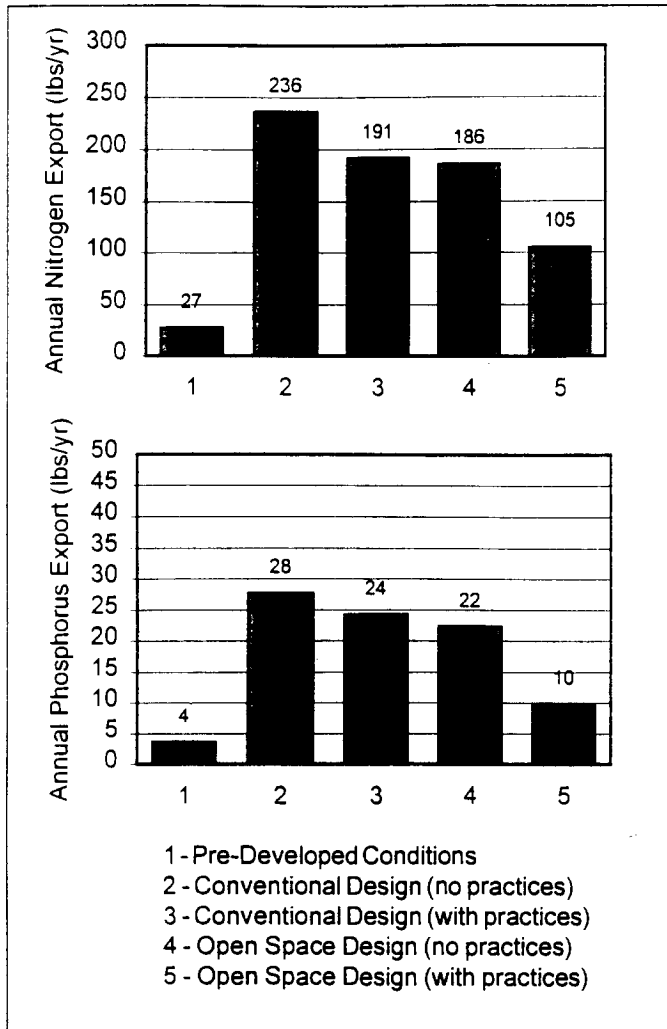

Figure 10: Annual Nitrogen and Phosphorus Loads for Each Stonehill Estates Development Scenario

Table 2: Comparative Hydrology of Stonehill Estates

		Pre-Developed	Conventional Design	Open Space Design
Runoff (inches/year)	no practice	2.1	10.6	8.8
	practices	n/a	10.6	8.0
Infiltration (inches/year)	no practice	4.9	3.1	4.0
	practices	n/a	3.1	4.8

**Table 3: Redesign Analyses Comparing Impervious Cover and Stormwater Runoff from Conventional and Open Space Subdivisions**

Residential Subdivision	Original Zoning for Subdivision	Impervious Cover at the Site			Reduction in Stormwater Runoff (%)
		Conventional Design	Open Space Design	Net Change	
Remlik Hall <sup>1</sup>	5 acre lots	5.4 %	3.7%	- 31%	20%
Tharpe Knoll <sup>2</sup>	1 acre lots	13%	7%	- 46%	44%
Chapel Run <sup>2</sup>	½ acre lots	29%	17%	- 41%	31%
Pleasant Hill <sup>2</sup>	½ acre lots	26%	11%	- 58%	54%
Prairie Crossing <sup>3</sup>	½ to 1/3 acre lots	20%	18%	- 20%	66%
Buckingham Greene <sup>2</sup>	1/8 acre lots	23%	21%	- 7%	8%
Belle-Hall <sup>4</sup>	High Density	35%	20%	- 43%	31%

Sources: <sup>1</sup> Maurer, 1996; <sup>2</sup> DE DNREC, 1997; <sup>3</sup> Dreher, 1994; and <sup>4</sup> SCCCL, 1995.

export from the conventional design would still be six to seven times greater than the pre-development condition even with this stormwater treatment practice.

In contrast, the open space design resulted in greater nutrient reduction (Figure 10). For example, the open space design scenario *without* stormwater practices produced a lower nutrient load than the conventional design scenario *with* stormwater practices. This was primarily due to lower impervious cover associated with the open space design. When the open space design was combined with more sophisticated stormwater practices (i.e., bioretention, dry swales and wet ponds), nutrient export was half that of the conventional design. It is interesting to note, however, that even when the most innovative site design and stormwater techniques were applied to the site, nutrient export was still three to four times greater than that produced by the forest prior to development.

**Infrastructure Costs**

The total cost to build infrastructure at Stonehill Estates was about 20% less for the open space design than for the conventional design. Considerable savings were realized in the form of less road paving and shorter lengths of sidewalks, water and sewer lines and curbs and gutters. The cost difference between the open space and conventional designs would have been greater were it not for the fact that higher costs were incurred for the more sophisticated stormwater practices used in the open space design. It was estimated that the infrastructure cost for the conventional design was \$1.54 million, compared to \$1.24 million for the open space design.

**Summary**

The comparative results for the Stonehill Estates redesign analysis are summarized in Figure 11. The open space design reduced impervious cover, natural area conversion, stormwater runoff, nutrient export and development costs compared to the conventional subdivision design.

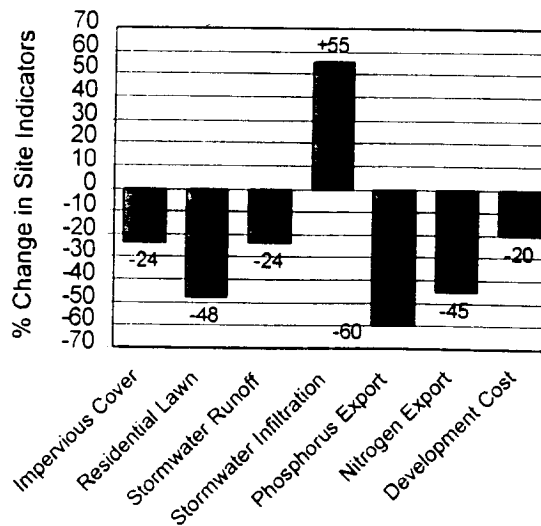

**Figure 11: Change in Site From a Conventional Design to an Open Space Design, Both With Stormwater Practices**

R0079722

**Table 4: Projected Construction Cost Savings for Open Space Designs from Redesign Analyses**

Residential Development	Construction Savings	Notes
Remlik Hall <sup>1</sup>	52%	Includes costs for engineering, road construction, and obtaining water and sewer permits
Tharpe Knoll <sup>2</sup>	56%	Includes roads and stormwater management
Chapel Run <sup>2</sup>	64%	Includes roads, stormwater management, and reforestation
Pleasant Hill <sup>2</sup>	43%	Includes roads, stormwater management, and reforestation
Buckingham Greene <sup>2</sup>	63%	Includes roads and stormwater management

Sources:<sup>1</sup> Maurer, 1996; <sup>2</sup> DE DNREC, 1997

**Other Redesign Research**

Several other researchers have employed redesign comparisons to demonstrate the benefits of open space subdivisions, over a wide range of base lot sizes. The results are shown in Table 3. It should be recognized that each study used slightly different models and assumptions, and as such, strict comparisons should be avoided. The redesign comparisons clearly show that open space designs can sharply reduce impervious cover and stormwater runoff while accommodating the same number of dwelling units, at least to base lot sizes of an eighth of an acre. The reductions in impervious cover and runoff range from seven to 65%. The ability of open space design to reduce impervious cover starts to diminish for residential zones that exceed densities of four dwelling units per acre.

These studies reinforce the conclusion that open space designs are usually less expensive to build than conventional subdivisions. The projected construction cost savings associated with open space designs ranged from 40 to 66% (Table 4). Most of the cost savings were due to reduced need for road building and stormwater conveyance. In another study, Liptan and Brown (1996) reported that open space design produced infrastructure construction costs savings of \$800 per home in a California subdivision.

Numerous economic studies have shown that well-designed and marketed open space designs are very desirable to home buyers and very profitable for developers. Strong evidence indicates that open space subdivisions sell faster, produce better cashflow, yield a higher return on investment and appreciate faster than their traditional counterparts (Arendt *et al.*, 1994, Ewing, 1996, NAHB, 1997, ULI, 1988, CWP, 1998a, and Porter, 1988). While open space designs are often perceived as applying only to upscale and affluent consumers, several successful open space subdivisions have been

built for moderate to lower income buyers. Both ULI (1988) and Ewing (1996) report that open space designs can be an effective tool to promote affordable housing within local communities.

The relatively high demand for open space designs reflects two important economic trends. The first trend is that the tastes and preferences of many new home buyers are gradually changing. Recent market surveys indicate that home buyers increasingly desire natural areas, smaller lawns, better pedestrian access, wildlife habitat and open space in the communities they choose to live in. The second trend is that open space developments that can provide these amenities seldom comprise more than 5% of the new housing offered in most communities. Consequently, there appears to be a large and relatively untapped potential demand for more open space developments. Other compelling benefits of open space design are detailed in CWP (1998a) and Schueler (1995).

**Evaluating the Quality of Individual Open Space Developments**

In the real world, site designers must satisfy a wide range of economic objectives, and water quality or resource protection is usually not on the top of the list. It is certainly possible to design a lousy open space design, and communities should expect a wide range in the quality of open space designs they review. How can a community objectively evaluate the quality of individual open space design proposals, and differentiate poor or mediocre projects from the good and outstanding ones?

**R0079723**



**Table 5: Sample Evaluation Criteria for the Quantity and Quality of Open Space Development (Conservation Fund, 1999)**

Points Achieved by the Development	Percent of Open Space Achieved for Different Residential Zones				
	More than 4 units per acre	From 2 to 4 units per acre	From 1 to 2 units per acre	From 0.5 to 1 unit per acre	less than ½ unit per acre
-2	0 to 9%	less than 15%	15 to 24%	25 to 34%	less than 40%
-1	10 to 14%	15 to 24%	25 to 34%	35 to 49%	less than 50%
0	15 to 24%	25 to 34%	35 to 49%	50 to 59%	less than 60%
+1	25 to 30%	35 to 40%	50 to 55%	60 to 70%	less than 70%
+2	more than 30%	more than 40%	more than 55%	more than 70%	more than 80%

The total open space achieved by the site is computed using the following formula:

$$\frac{A(0.2) + B(0.2) + C(0.5) + D}{E} \times 100$$

A = open space acres in managed landscape

B = open space acres in annual crops

C = open space acres in perennial crops

D = open space acres in native vegetation

E = total undeveloped acres in open space

Nerenberg and Freil (1999) have recently developed a simple rating system to evaluate the quality of individual open space design proposals. The rating system, known as the Conservation Development Evaluation System (CeDES), was developed in consultation with a host of planning agencies and organizations. The CeDES employs 10 core criteria to test how well a proposed open space design reduces impervious cover, minimizes grading, prevents soil loss, reduces and treats stormwater, manages open space, protects sensitive areas, and conserves trees or native vegetation. Each of the 10 core criteria has a quantitative benchmark for comparison. An example of one benchmark that rates the quantity and quality of open space is provided in Table 5. A full description of the CeDES rating can be found in Conservation Fund (1999).

Based on the total score achieved under the 10 core criteria, an open space design project can earn anywhere from zero "oak leaves" up to four "oak leaves." The more oak leaves earned, the better the quality of the proposed project. Based on initial testing, the CeDES seems to do a good job of sorting the poor projects from the outstanding ones. While the CeDES is intended for use as a tool for local development review, it can also be used as a marketing tool to let home buyers know how green their new subdivision actually is.

#### Implications for the Watershed Manager

The redesign comparisons have several implications for the watershed manager. First, they offer compelling quantitative evidence that open space design can sharply reduce stormwater and nutrient export from new development, and as such, can serve as an effective tool for watershed protection. It is interesting to note

that open space design, by itself, produced nutrient reductions roughly equivalent to those achieved by structural stormwater practices. In other words, nutrient export from open space designs *without* stormwater treatment was comparable to the conventional designs *with* stormwater treatment. When open space design were combined with effective stormwater treatment, nutrient loads were sharply reduced, but were still greater than pre-development conditions.

A second, more troubling implication is that it may well be impossible to achieve a strict goal of no increase in nutrient load for new development, even when the best site design and most sophisticated stormwater practices are applied. A handful of communities have adopted stormwater criteria that mandate that no net increase in phosphorus load occur as a result of development, but as the redesign comparisons in this article show, such criteria are not likely to be actually achieved. Thus, if nutrient loads are capped in a watershed, managers may need to remove pollutants at existing developments with stormwater retrofits in order to offset increases in nutrient loads produced by new development.

The redesign research also has some implications for watershed-based zoning. Quite simply, a shift from conventional to open space design can reduce the impervious cover of many residential zoning categories by as much as 30 to 40%. In some watersheds, an aggressive shift to open space design in new residential zones is an essential strategy to meet an impervious cover cap for protecting sensitive or impacted streams.

Another notable finding is that large lot subdivisions have the potential to generate the same unit area nutrient export as higher density subdivisions. The



R0079724

high nutrient loading from large lot developments in unsewered areas is attributed to subsurface discharges from septic systems. From a nutrient management standpoint, it may be more cost effective to regulate septic system performance than stormwater performance in very low density residential subdivisions located on permeable soils.

Lastly, watershed managers have only a few tools at their disposal that offer developers a real chance to save money. The economic evidence clearly suggests that open space design is such a tool, and has potential to either reduce the cost of development, or at least offset the cost of other watershed protection measures. However, despite its economic and environmental benefits, open space design is not a development option in many communities, nor is it widely used by most developers even when available. Many communities will need to fundamentally change their local development rules in order to make open space design an attractive development option.

Site planning roundtables that involve the local players that shape new residential development, described later in this issue, are an effective way to bring this change about. The ultimate goal is to make open space design a "by-right" form of development, so that its design, review and approval are just as easy and certain as a conventional subdivision. Who knows, the day may come when a special exception or permit is needed to build a conventional subdivision. - JAZ

#### References

- Arendt, Randall. 1994. *Designing Open Space Subdivisions: A Practical Step-by-Step Approach*. Natural Lands Trust. Media, PA. 96 pp.
- Center for Watershed Protection (CWP). 1998a. *Better Site Design: A Handbook for Changing Development Rules in Your Community*. Ellicott City, Maryland. 202 pp.
- CWP, 1998b. *Nutrient Loading From Conventional and Innovative Site Development*. Prepared for Chesapeake Research Consortium. Ellicott City, Maryland. 96 pp.
- Conservation Fund. 1999. *Pilot Conservation Development Evaluation System*. Great Lakes Office. [available at [www.conservationfund.org/conservation/sustain/gloindex.html](http://www.conservationfund.org/conservation/sustain/gloindex.html)].
- Delaware Dept. of Natural Resources and Environmental Conservation (DE DNREC). 1997. *Conservation Design for Stormwater Management*. Dover, DE.
- Dreher, D, and T. Price. 1994. *Reducing the Impact of Urban Runoff: The Advantages of Alternative Site Design Approaches*. Northeastern Illinois Planning Commission. Chicago, IL.
- Ewing, R. 1996. *Best Development Practices: Doing the Right Thing and Making Money at the Same Time*. American Planning Association, Chicago, IL.

- Liptan, T. and C. Brown. 1996. *A Cost Comparison of Conventional and Water Quality-based Stormwater Designs*. City of Portland. Portland OR.
- Maurer, G. 1996. *A Better Way to Grow: For More Livable Communities and a Healthier Chesapeake Bay*. Chesapeake Bay Foundation. Annapolis, MD. 24 pp.
- National Association of Homebuilders. 1986. *Cost Effective Site Planning*. Washington DC.
- Nerenberg, S. and K. Freil. 1999. *The Conservation Development Evaluation System (CeDES): Evaluating Environmentally Friendly Developments*. Land Development. Fall, 1999. pp. 22-28
- Porter, D., P. Phillips, and T. Lassar. 1988. *Flexible Zoning: How it Works*. Urban Land Institute, Washington, DC. 200 pp.
- Schueler, T. 1995. *Site Planning for Stream Protection*. Center for Watershed Protection. Ellicott City, MD. 220 pp.
- Urban Land Institute. 1988. *Density by Design*. J. Wetling and L. Bookout, editors. Urban Land Institute, Washington, D.C.

R0079725



## Description of the Simplified Urban Nutrient Output Model

The basic tool used in the redesign analysis was a spreadsheet model known as the Simplified Urban Nutrient Output Model (SUNOM). The SUNOM model computes the annual hydrologic budget, nutrient export and infrastructure cost for individual development sites, using simple input variables that can be easily derived or measured from any site engineering plan.

The first step in applying the SUNOM model is to measure the fraction of the site in each of six categories of surface cover: impervious surfaces, lawns, forests/wetlands, meadow, open water, and stormwater treatment areas. In the next step, the user measures key infrastructure variables from the site plan including the length of roads, sidewalks, water and sewer utilities, curb and gutter, and storm drain pipes (in some cases, widths or diameters are needed as well). Basic soil type data is then collected, in order to classify soils according to the hydrologic soil group(s) present on the pervious surfaces of the site. Lastly, basic data is assembled on the size and type of stormwater practices and septic systems, when present. Depending on the size and complexity of the plan, it typically takes about a day to derive all the necessary inputs to operate the model.

### *Estimating Hydrology for the Site*

SUNOM operates based on a simplified water balance. Rainfall can take several different pathways once it reaches the ground surface. A fraction of the rainfall leaves the site directly as stormwater runoff, while the remainder infiltrates into the subsurface soils (storage in surface depressions or interception by the tree canopy interception is ignored in the model, since they are a small and often temporary component of the annual water balance). Once water infiltrates into the soil, much of it returns to the atmosphere through evapotranspiration. The remainder moves to shallow ground water, is transported as interflow, or recharges deeper groundwater. The SUNOM model does not differentiate between these three final destinations, but simply computes the total volume of subsurface infiltration. The water budget can be adjusted further if lawn irrigation or septic system effluent is expected to contribute "outside" water to the development site.

Surface runoff from all surfaces is calculated using a volumetric runoff coefficient that is closely related to impervious cover. Resulting runoff quantities are normalized to runoff inches over the entire site (Schueler, 1987). Surface runoff from natural cover and turf are computed assuming that these areas are one percent impervious (NVPDC, 1980), but these values can be changed to reflect the prevailing soil type or soil compaction (see article 36).

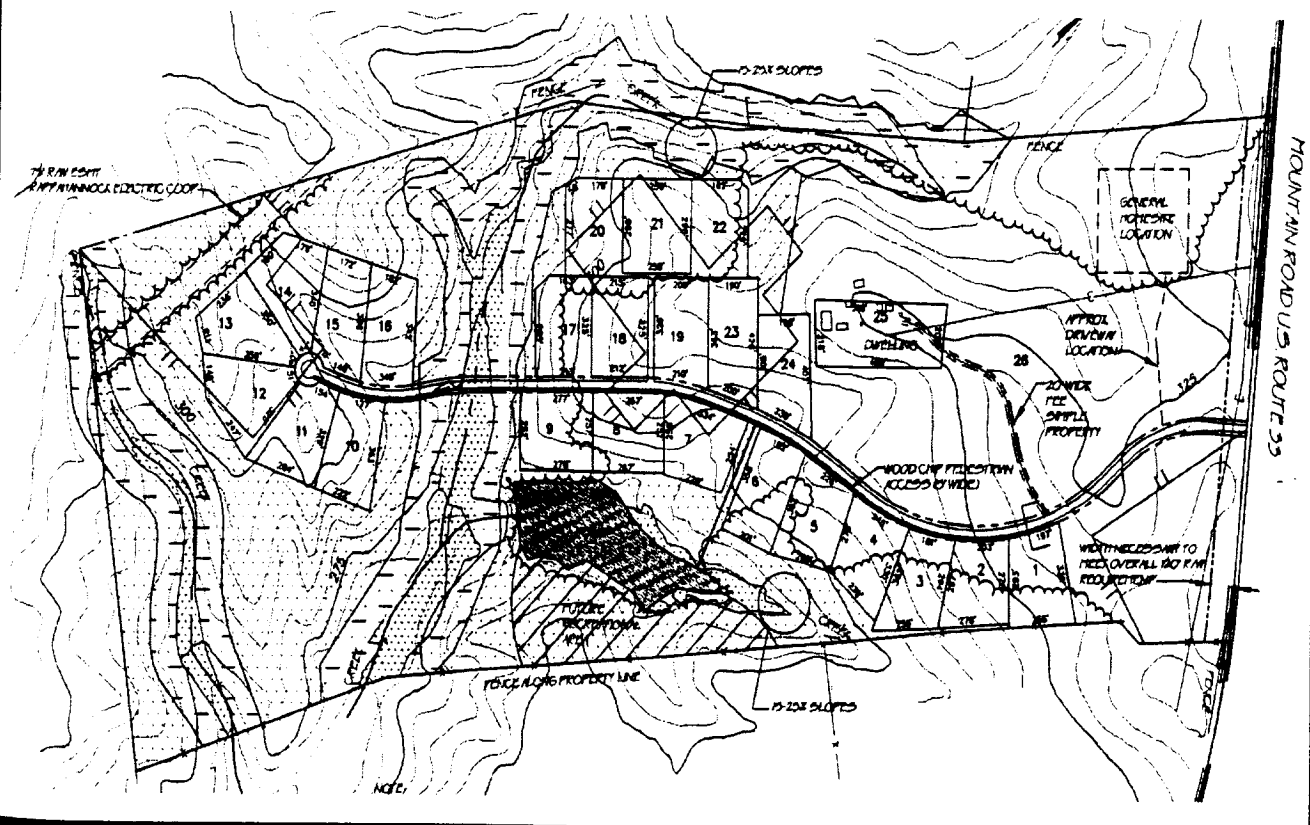

Figure 1: The SUNOM Model Operates Using Basic Site Variables That Can Be Easily Derived From Most Site Plan Submittals

Estimating infiltration is a somewhat trickier affair. For the purposes of the model, total infiltration is defined as the sum of subsurface infiltration plus septic infiltration. Subsurface infiltration is estimated based on annual infiltration volume for the prevailing hydrologic soil group of the pervious area, which can be adjusted for soil compaction. The annual volume of subsurface infiltration is calculated without estimating its final destination (i.e., quick interflow, deep recharge, shallow groundwater). Once annual stormwater runoff and subsurface infiltration volumes are calculated, they can be checked against an annual evapotranspiration volume to ensure that the overall water balance is reasonable.

Annual septic system infiltration is calculated under the assumption that entire wastewater flow into a septic system infiltrates to the subsurface. The volume of this wastewater flow, in site-inches, is derived as a function of the number of individuals using each septic system multiplied by their per capita annual water use. Some stormwater practices can take surface runoff and convert it into subsurface infiltration. The model accounts for this by deducting the fraction of treated runoff volume that is infiltrated back into the soil from the annual stormwater runoff volume and adding it to the infiltration volume.

#### *Calculation of Nutrient Loads*

This module computes nutrient loads for each of the types of surface cover present at a site by multiplying its computed stormwater runoff and subsurface infiltration volume by a median nutrient concentration. For stormwater flows, the mean concentrations are derived based on national stormwater monitoring data or single land use or source area marketing data. Subsurface nutrient concentrations for natural areas are estimated based on measured baseflow concentrations from adjacent undeveloped receiving waters. Median nutrient concentrations from published sources were used to characterize the subsurface concentrations from turf areas. In the case of septic systems, typical per capita septic loads, along with septic efficiencies, were used to characterize this nutrient loading source.

The total annual nutrient load for a development site is then computed as the sum of the stormwater runoff load, and the subsurface infiltration load from natural areas, turf, and septic systems. Surface stormwater loads are adjusted to reflect pollutant reduction by stormwater practices if they are present. The spreadsheet contains typical nutrient removal rates for many common stormwater practices (see article 64). Subsurface infiltration loads can also be adjusted to reflect the use of innovative septic system technology with higher nutrient removal capability. Default data are provided in the SUNOM model for all nutrient concentration and removal parameters, but the user can also supply their own estimates if better local or regional data are available.

#### *Development Cost*

The SUNOM modules computes the cost of building the infrastructure to serve a new development. The module calculates these costs based on the dimensions of the infrastructure that are specified in the development plan, and supplied as model input (e.g., length and area of roads, length and diameter of pipe). These units of infrastructure are then multiplied by unit costs that were derived for the mid-Atlantic region. The SUNOM model can estimate the following component costs: paving for roads or parking lots, curb and gutter, sidewalks, stormwater conveyance, utilities, landscaping, reforestation, septic systems and other necessary elements for site construction. Stormwater treatment costs are calculated as a function of the volume of stormwater runoff treated by the practice using predictive equations developed by the Center (see article 68). At this time, the SUNOM model does not estimate engineering or permitting costs, nor does it itemize costs related to clearing, grading and erosion and sediment control, but these enhancements can be added by the user.

#### *Appropriate Use of the SUNOM Model*

The SUNOM model is basically a simple accounting tool to track the annual runoff, nutrient loads, and total infrastructure costs from four kinds of surface cover in a development plan. The model is most appropriately used as a tool to compare how these factors change in response to different development scenarios. These "redesign" scenarios help demonstrate the costs and benefits of better site design. As with any empirical model, it is very important to make sure that parameter values are sensible and regionally appropriate. The user should always check whether default infiltration rates, nutrient concentrations, removal rates and unit costs make sense given local conditions. The SUNOM model is intended to serve as a planning model rather than an engineering model. More detailed simulation models or monitoring may be required to give the precise and accurate predictions needed for actual engineering design at a given development site. More extensive documentation on the model is contained in Appendix A of CWP, 1998. We are continually improving the SUNOM model, and the most recent version, which utilizes a Microsoft Excel spreadsheet, is available through the Center at a nominal charge.

#### **References**

- Center for Watershed Protection (CWP). 1998. *Nutrient Loading From Conventional and Innovative Site Development*. Ellicott City, MD.
- Northern Virginia Planning District Commission (NVPDC). 1980. *Guidebook for Screening Urban Nonpoint Pollution Management Strategies*. Metropolitan Washington Council of Governments. Falls Church, VA.
- Schueler, T. 1987. *Controlling Urban Runoff: A Practical Manual for Planning and Designing Urban BMPs*. Metropolitan Washington Council of Governments. Washington, DC.

**R0079727**

# The Benefits of Better Site Design in Commercial Development

**M**odern commercial development is dominated by the parking lot. Indeed, as much as half of the entire surface area of a typical office park or shopping center is devoted to parking. No one has ever stepped up to claim that they invented the parking lot, and their reluctance is understandable: the parking lot is a prime habitat for the car and not much else.

From an environmental standpoint, parking lots rank among the most harmful land uses in any watershed. Parking lots not only collect pollutants that are deposited from the atmosphere, but also accumulate pollutants that leak, drip or wear off cars. Researchers have found that parking lot runoff can have extremely high concentrations of nutrients, trace metals and hydrocarbons. Parking lots also influence the local air and stream temperatures. In the summer months, pavement temperatures can exceed 120 degrees Fahrenheit, which in turn increases local air temperatures five to 10 degrees compared to a shaded forest. Parking lots can also exacerbate smog problems, as parked cars emit greater levels of smog precursors under extreme heat island conditions (Scott *et al.*, 1999).

Perhaps the greatest environmental impact of parking lots is hydrological in nature. Simply put, there is no other kind of surface in a watershed that produces more runoff and delivers it faster than a parking lot. When this runoff is discharged into a headwater stream, its great erosive power steadily degrades the quality of downstream habitats, unless exceptionally sophisticated stormwater practices are installed.

Is it possible to design a better parking lot? At first glance, there seems to be little opportunity to incorporate better site design into parking lots. However, the better site design techniques described in article 45 suggest a key design strategy: *work to incrementally shrink the surface area of the parking lots and then use the space saved to integrate functional landscaping and better stormwater treatment within the parking lot.* Through a series of relatively minor design adjustments, it is possible to reduce the surface area of parking lots by five to 20%. These design adjustments include curbing excess parking, incrementally reducing parking demand ratios, providing credits for mass transit, shrinking stall sizes, narrowing drive aisles, and using grid pavers for spillover parking areas.

In this article, we examine some of the benefits of employing better site design as they apply to commercial development. As with the residential redesign, this analysis also uses the Simplified Urban Nutrient Output Model (SUNOM) to compare actual commercial development sites constructed in the 1990s with the same sites redesigned utilizing better site design techniques. The two commercial developments analyzed include a retail shopping center and a commercial office park.

Our fairly conservative approach to parking lot redesign is intended to reflect realistic opportunities in a suburban setting. For example, we did not utilize shared parking, porous pavement, or structured parking in any of the redesigns, although each of these techniques is very effective. Nor did we reduce the basic footprint or size of the buildings in either scenario, although smaller "boxes" may well have been more appropriate for the zoning. Instead, our basic approach was to make a series of relatively modest changes in parking lot design to shrink parking lot area, and then implement better landscaping and stormwater treatment measures within the saved space.

This article reports on the potential benefits of parking lot redesign in terms of reduced runoff, pollutant export and development costs. It also reviews the initial experience of communities that are experimenting with new and innovative parking lot designs, and concludes with some implications for both the engineer and watershed manager.

R0079728

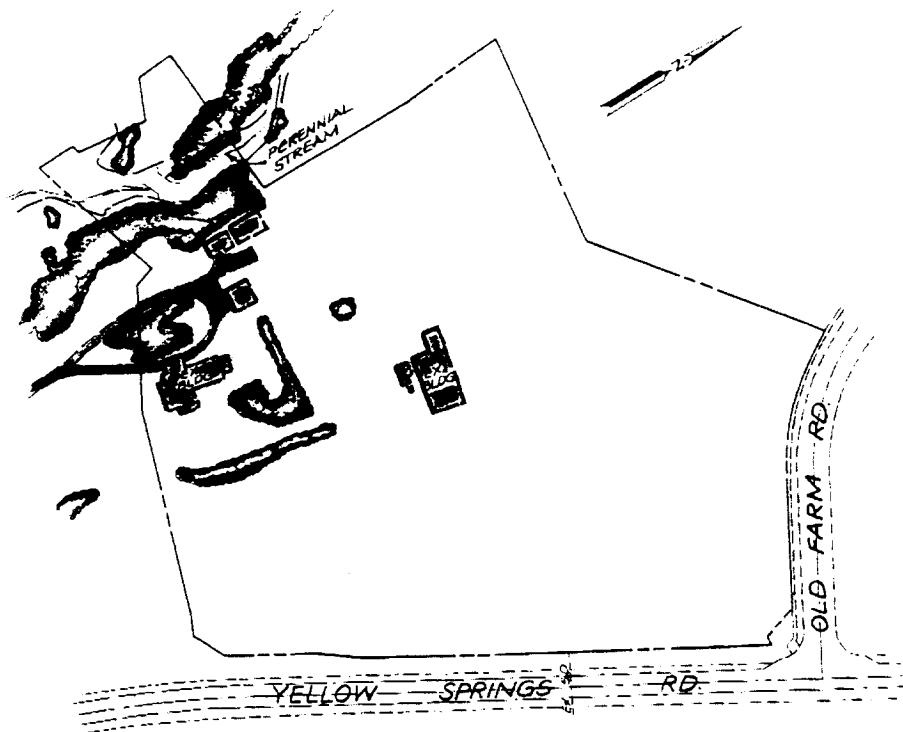

Figure 1: Predevelopment Conditions at the Old Farm Shopping Center Site

#### Redesign of the Old Farm Shopping Center

The undeveloped Old Farm shopping center, located in the City of Frederick, Maryland, was primarily meadow, with some shrubby forest and a few farm buildings. Bordered by two major arterial roads and served by existing public water and sewer, the site was a prime candidate for commercial development (Figure 1).

Construction of the shopping center site parcel commenced in 1992. The 9.3 acre site is a typical suburban "strip" shopping center with two large retail stores, other retail space, a gas station and a drive-in bank (Figure 2). In terms of surface cover, the shopping center devoted 50% of its total area for parking, as compared to 16% for the actual footprint of the retail buildings. Another 24% of the surface area was devoted to landscaping or stormwater treatment. Less than 10% natural cover was retained on the site, and part of the project encroached on the 100-year floodplain and the stream buffer. The entire site was mass graded during construction. The basic layout was designed to accommodate the car, with generous parking located in front of the stores. The parking lot design provided 5.2 full-size stalls per 1,000 square feet (sf) of retail space, which exceeded the already generous local parking requirement of five spaces per 1,000 sf. According to the most recent national parking research, only 4.0 to 4.5 spaces are needed to serve shopping centers (ULI, 1999).

The stormwater treatment system at Old Farm consisted of an infiltration basin located near the rear of the shopping center that captured runoff from about a third of the site, and three oil/grit separators that provide some treatment for the remaining two-thirds of the site. After discharging from the oil/grit separators, runoff traveled through a series of storm drains that extended along the road and eventually discharged to the stream (albeit without detention of any kind). It should be noted that recent performance monitoring has shown that oil/grit separators have little or no pollutant removal capability (see articles 119 and 120).

#### The Redesigned Old Farm Shopping Center

The Old Farm shopping center was redesigned using a "U-shaped" layout that maintained the same amount of gross floor area, but sharply reduced the site area devoted to parking (Figure 3). The new design reduced walking distances, encouraged pedestrian use, and created a more intimate shopping experience. Parking dropped from 50% of the total site area to 38%, primarily because the parking demand ratio was reduced from 5.2 spaces to 4.4 spaces per 1,000 sf of retail area.

The rationale for the lower parking demand was justified in two ways. First, no extra parking spaces were allowed beyond those required by the locality. Second,

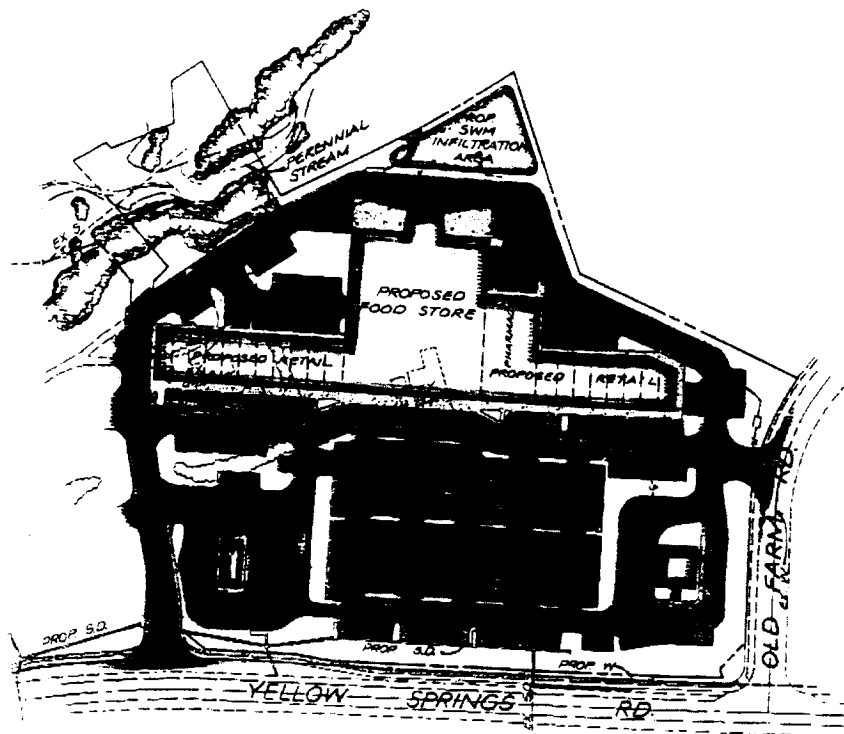

Figure 2: The Conventional Design of the Old Farm Shopping Center

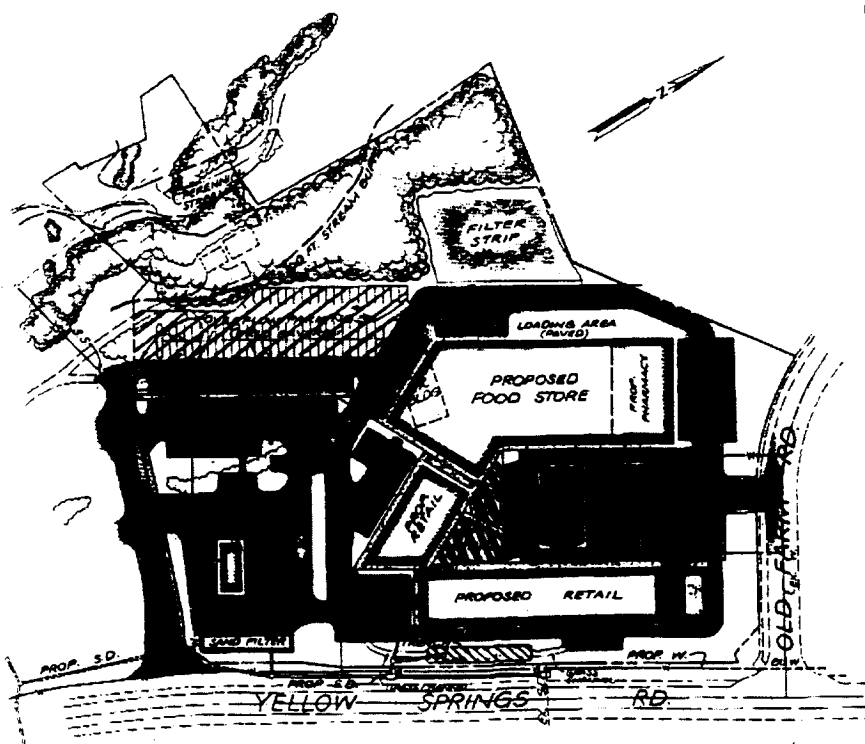

Figure 3: The Innovative Design of the Old Farm Shopping Center

**Table 1: Hydrology of the Old Farm Shopping Center Case Study**

		Pre-Developed	Conventional Parking Lot	Innovative Parking Lot
Runoff (inches/yr)	no practice	2.6	24.5	20.6
	practices		18.1	15.1
Infiltration (inches/yr)	no practice	11.8	2.7	3.4
	Practices		9.1	8.9

the existing parking demand ratio was reduced by about 15% to reflect actual parking demand more accurately. As a result, the total number of parking spaces dropped from 343 to 291. In addition, 17% of the parking stalls were designed for compact cars, which require slightly smaller stalls than standard full-sized spaces. Taken together, these changes eliminated slightly more than one acre of parking area, which provided enough space to design a more effective landscaping and stormwater treatment system.

Several parking lot islands were increased in size and converted into bioretention areas to treat stormwater. Other elements of the stormwater treatment system included a sand filter, an infiltration trench, and a filter strip. Furthermore, 25% of the entire parking area was designated for "spillover parking," and grid pavers were used rather than normal paving materials. The grid pavers helped store the first few tenths of an inch of rainfall that would have otherwise run off the parking lot (ICPI, 2000). Lastly, the redesign enabled reforestation and greater protection of the buffer along the stream that runs along the edge of the property. As a result, the proportion of natural cover at the site climbed from 7% to 19% as a result of the parking lot redesign.

*Comparative Hydrology at the Old Farm Shopping Center*

As expected, the construction of the original shopping center dramatically changed the hydrology of the site (Table 1). The increase in impervious cover from 1% to more than 70% increased annual runoff volume by a factor of nine. The infiltration basin used in the original design helped put some runoff back into the ground, but even so, annual runoff was seven times greater than the pre-development condition. The redesigned parking lot, by virtue of its lower impervious cover and improved stormwater practices, produced about 20% less runoff than the original design. Nevertheless, the stormwater practices at the redesigned parking lot were not able to match the pre-development hydrology.

*Comparative Nutrient Output from the Old Farm Shopping Center*

The conversion of the meadow into a shopping center greatly increased nutrient export from the site; the SUNOM model indicated that annual phosphorus and nitrogen export would increase tenfold as a result of the development (see Figure 4). Nutrient export from the shopping center was dominated by stormwater runoff, as the model indicated that stormwater runoff contributed about 95% of the annual nutrient export from the site. Nutrient loads were not greatly reduced by the infiltration basin or oil/grit separators that were installed at the conventional parking lot. Nutrient export was still projected to be eight to 10 times higher than pre-development conditions, even after these stormwater treatment practices were installed.

In contrast, the redesigned parking lot sharply reduced nutrient export (Figure 4). In fact, the redesigned parking lot *without* stormwater practices produced about the same nutrient load as the conventional parking lot *with* stormwater practices. This reduction was a direct result of the lower impervious cover associated with the redesigned parking lot. When the redesigned parking lot was combined with more sophisticated stormwater practices (i.e., bioretention, sand filter, infiltration trench and filter strip), the total nutrient export was half that of the conventional parking lot with stormwater practices. It is interesting to note, however, that this load was still about five times higher than that produced by the meadow prior to development.

*Comparative Cost to Develop the Old Farm Shopping Center*

The cost to develop the redesigned parking lot was marginally lower than the cost for the conventional parking lot — about 5%. Considerable cost savings were realized due to less paving, shorter sidewalks, and fewer curbs and gutters, but these savings were largely offset by added costs for improved stormwater practices, landscaping and grid pavers. Overall, the estimated cost to build the conventional parking lot was \$782,500, compared to \$746,270 for the redesigned parking lot. The extent of potential cost savings depends

heavily on the level of sophistication of the original stormwater treatment system. In this case, the unsophisticated stormwater practices used in the conventional parking design were fairly inexpensive, but were also not effective in removing nutrients.

**Summary**

Figure 5 summarizes the redesign analysis of the Old Farm Shopping Center. The redesigned parking lot resulted in less impervious cover, stormwater runoff, and nutrient export for a slightly lower development cost than the conventional design.

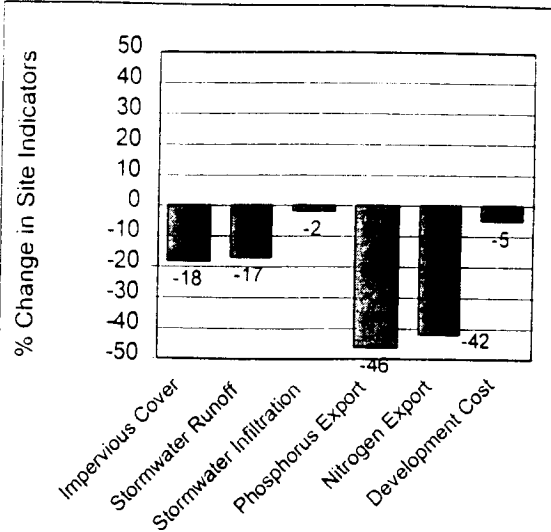

**Figure 5: Percentage Change in Key Site Indicators From a Conventional Design of the Old Farm Shopping Center to an Innovative Design, Both With Stormwater Practices**

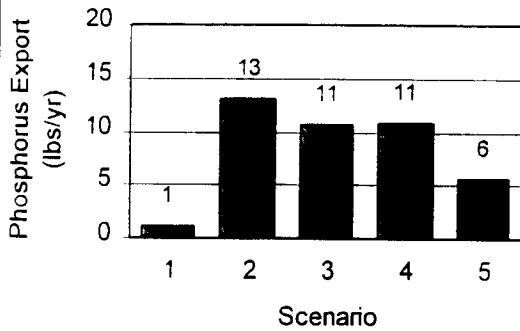
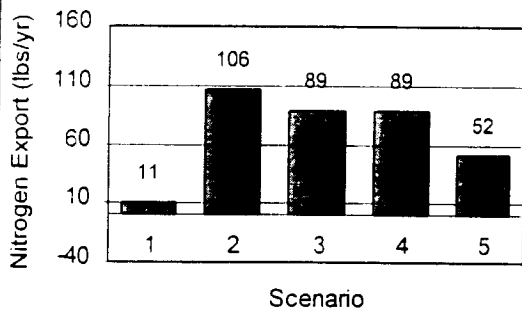

- 1 - Pre-Developed
- 2 - Conventional Design (no practices)
- 3 - Conventional Design (with practices)
- 4 - Open Space Design (no practices)
- 5 - Open Space Design (with practices)

**Figure 4: Annual Nitrogen and Phosphorus Export in Each Old Farm Shopping Center Development Scenario**



R0079732

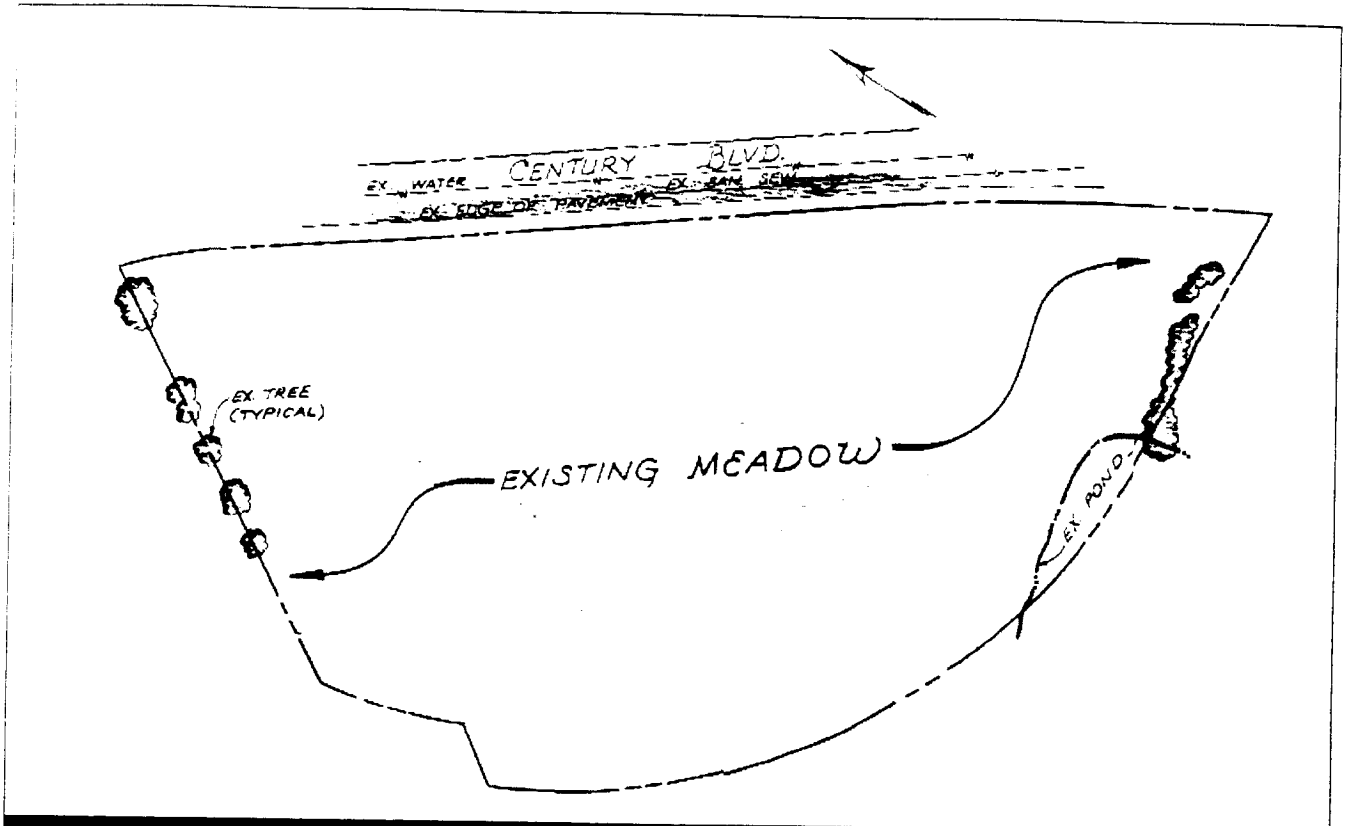

Figure 6: Predevelopment Conditions at the 270 Corporate Office Park Site

6

**Redesigning the 270 Corporate Office Park**

The second case study involved the redesign of a typical suburban office park. The 12.8 acre parcel is located in Germantown, Maryland in the mildly sloping terrain of the Piedmont (Figure 6). The existing cover at the site was almost entirely meadow, except for a few trees and an old farm pond that bisected the property boundary. No wetlands or other sensitive natural features were evident on the site. The site was zoned for office development, and existing infrastructure made it an attractive candidate for development. An existing network of public water and sewer, electric, gas, and other utilities ran along the frontage of a large arterial road.

The layout of the conventional suburban office park design is depicted in Figure 7. The project included a pair of five-story office buildings, surrounded by a sea of parking. Over half (52%) of the surface cover at the office park was devoted to parking, as compared to only 11% for actual footprint of the office building. Most of the remainder of the site was utilized for landscaping, stormwater treatment or turf. Only 2% of the natural cover was retained on the site, and nearly all of the parcel was mass graded during construction.

As with many suburban office parks, the location of the building and parking were primarily oriented toward the car. The parking lot was sized using a parking demand ratio of 3.1 spaces per 1,000 sf of building, which slightly exceeded the minimum parking requirements of the locality. As a result, the parking lot created room for 745 standard stalls, along with 33 larger stalls for vans and disabled access. The parking bays also featured roomy aisles between the stalls (24 feet wide). The design was intended to provide some amenities for the office workers, including a short path system between buildings, an ornamental stormwater pond, and some landscaping in required setbacks and parking islands.

The conventional design featured the classic "pipe and pond" approach to stormwater management. Parking lot runoff was initially collected by a curb and gutter system that sent runoff into underground storm drain pipes that, in turn, discharged into two very small wet ponds. Each pond served roughly half of the site and was expected to have a reasonably good capability to remove nutrients.

R0079733



R0079734

Figure 8: The Innovative Design of the 270 Corporate Office Park

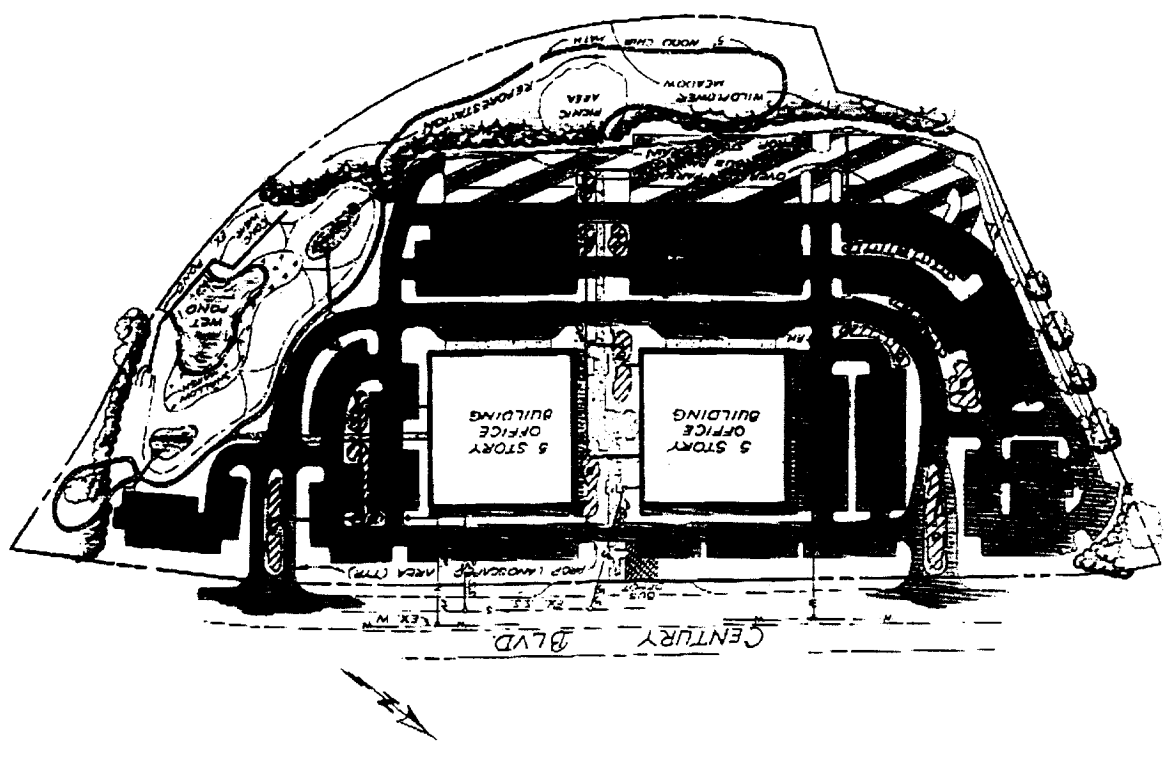
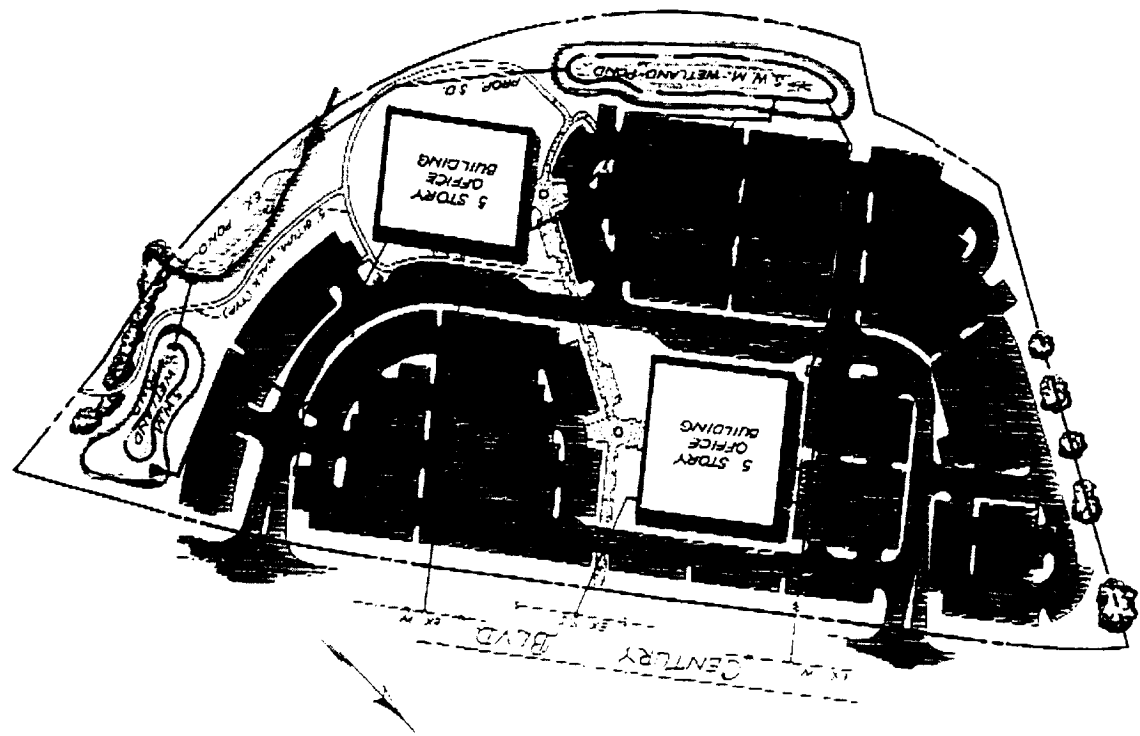

Figure 7: The Conventional Design of the 270 Corporate Office Park



6

### *The Redesigned 270 Corporate Office Park*

The redesigned site employed a number of techniques to minimize impervious cover and improve stormwater treatment (Figure 8). The office park featured the same amount of office space, but the two office towers were situated closer to the road to shorten utility extensions, and pedestrian access to a bus stop was provided to encourage the use of public transportation.

The key strategy employed in the redesign was to incrementally reduce the size of the parking lot, and this was achieved in five ways. First, no excess parking spaces were allowed over those required by the local parking demand ratio. Second, the local parking demand ratio was reduced by 8% to reflect actual parking demand. Third, the parking demand ratio was reduced by another 10% to reflect the proximity to the bus stop. Fourth, the size of approximately 20% of all parking stalls was downsized to accommodate compact cars. Lastly, drive aisles in many parking bays were reduced from 24 feet in width to 20 feet. Combined, these measures reduced the total parking lot area by nearly 30%, or about two acres. Once again, the savings in paving gave the designer more room to integrate landscaping with more effective stormwater treatment.

For example, larger landscaping islands were installed in the parking lot to plant shade trees, and some of these areas were also converted into bioretention areas to treat stormwater. A dry swale was used to treat stormwater within a landscaped setback area in another part of the site. About 15% of the lot was designated for spillover parking, and grid pavers were used to attenuate runoff in this area. The basic stormwater management goal was to attenuate, treat, or recharge as much runoff from smaller storms as possible in the parking lot itself. Runoff from larger storms was treated in a wet detention pond near the outlet of the property.

As a result of the redesign, roughly 14% of the office park was either retained as natural land cover or reforested (compared to 2% under the conventional design). This green space, combined with the water features and a walking path, created a more tranquil environment for office workers. Overall, the total impervious area associated with the redesigned office park dropped from 68% to 53%.

### *Comparative Hydrology for the 270 Corporate Center Office Park*

The hydrological story was much the same for the 270 Corporate Center as for the shopping center. Construction of the conventional design sharply increased annual runoff volumes and decreased infiltration (Table 2). Runoff did not increase as much in the redesigned parking lot, primarily because its impervious cover was much lower. Annual runoff volumes were 21% lower in the redesigned parking lot compared to the conventional design, and infiltration volumes were 42% higher. Despite these improvements, the redesigned parking lot was unable to mimic the hydrologic conditions prior to development.

### *Nutrient Output at the 270 Corporate Center Office Park*

As expected, the conversion of the meadow into an office park greatly increased nutrient export. Annual phosphorus and nitrogen export increased roughly tenfold, according to the SUNOM model (Figure 9). As with the shopping center, stormwater runoff was found to generate about 95% of the annual nutrient export from the site. The two wet ponds were reasonably effective in removing nutrients at the conventional office park, but still resulted in nutrient export that was seven to eight times higher than pre-development conditions. In contrast, the redesigned parking lot sharply reduced nutrient export (Figure 9). The combination of lower impervious cover and more effective stormwater practices reduced nutrient export by about 40 to 50%, when compared to the conventional parking lot design with stormwater practices.

Table 2: Hydrology of the 270 Corporate Office Park Case Study

Hydrologic Factor	Pre-Developed	Conventional Parking Lot	Redesigned Parking Lot
Runoff (inches/yr)	2.7	23.9	18.9
Infiltration (inches/yr)	11.8	2.6	3.7

Note: no change in the annual volume of runoff or infiltration was calculated as a result of the stormwater practices installed at either the conventional or redesigned parking lot.

*Comparative Cost to Develop the 270 Corporate Office Park*

The cost to develop the redesigned office park was approximately the same as the cost to develop the conventional office park, although the component costs were somewhat different. Less was spent on paving, sidewalks and utility pipes, but these savings were largely offset by higher costs for improved stormwater treatment practices, landscaping, grid pavers and curbs and gutters (the higher cost for this last item was due to the wider parking islands used for bioretention areas). Overall, the estimated cost to build the conventional parking lot was \$948,900, compared to \$921,200 for the redesigned parking lot.

**Overall Summary: Office Park Redesign**

The redesigned parking lot at the 270 Corporate Office Park resulted in less impervious cover, stormwater runoff, and nutrient export for about the same development cost as the conventional design. The results are summarized in Figure 10.

**The Limits and Potential of Parking Lot Redesign**

To our knowledge, no one has yet tried to quantify the potential economic and environmental benefits of better parking lot design at new commercial developments. This initial analysis provides compelling evidence that better site design is an important, if not indispensable, tool for managing the quantity and quality of stormwater runoff from parking lots.

In each of the case studies, the redesigned parking lot resulted in less impervious cover, stormwater runoff, and nutrient export for about the same or even slightly lower cost than the conventional design. Taken together, better site design techniques reduced impervious cover by at least 15% in each case. While this is an impressive reduction, about half of each site remained impervious after the redesign. Perhaps the most critical benefit of each redesign was that it created more room to locate more effective stormwater treatment practices. When smaller parking lots were combined with better stormwater practices, the resulting nutrient export was almost half that of a conventional parking lot.

In each case study, the critical ingredient was an incremental reduction in the local parking demand ratio. Without this capability to shrink the surface area devoted to parking, designers have little ability to devise the more sophisticated stormwater treatment and landscaping systems that can help mitigate the impact of the parking lot. Therefore, the first and most important step in implementing better site design for commercial developments is to reduce local parking demand ratios, even if only by

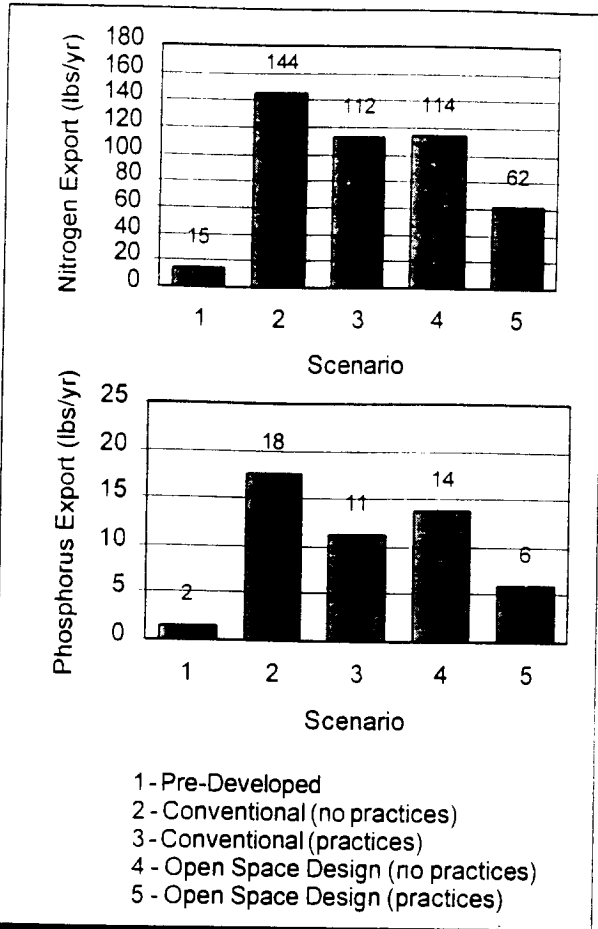

**Figure 9: Annual Nitrogen and Phosphorus Load in Each 270 Corporate Office Park Development Scenario**

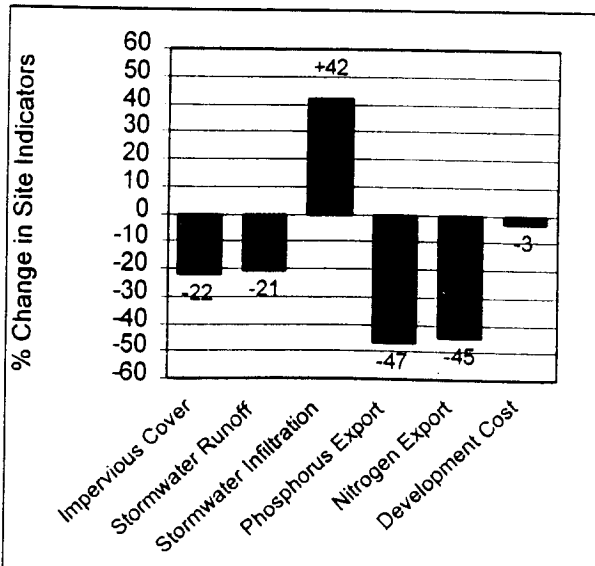

**Figure 10: Percentage Change in Key Site Conditions from a Conventional Design to a Redesigned Parking lot at the 270 Corporate Office Park, Both With Stormwater Practices**



five or ten percent. For many communities, however, this modest step may seem like a terrifying leap, possibly off a cliff.

Developers, bankers, retailers and drivers all have a shared interest in abundant and convenient parking, and it is hard to convince them that any attempt to downsize parking lots, however modest, will not work against this goal. This kind of thinking is quite understandable. Most people can easily recall the rare situation where parking was hard to find, but the more common situation where parking is plentiful generally escapes our everyday notice.

Small wonder, then, that so many communities are prone to inertia when it comes to changing parking codes. Perhaps the only way watershed advocates can overcome this inertia is to document the existence of excess parking capacity in each community. Indeed, it is a rather simple step for volunteers to count cars and photograph empty stalls during peak times at similar commercial land uses to demonstrate how generous local parking requirements actually are.

A small but growing list of communities are now experimenting with their parking standards and parking lot designs, including cities like Scarborough, Ontario; Oakland, CA; Olympia, WA; Sacramento, CA; Bellevue, WA; Davis, CA and Prince George's County, MD. Each community has worked in different ways to redesign their parking lots, and many of their successful experiences are recounted in *Better Site Design: A Handbook for Changing Development Rules in Your Community* (CWP, 1998a).

Given the prevalence of parking lots in our urban landscape and the environmental harm they cause, we need to fundamentally change the way that parking lots are sized and designed. The modest ideas presented in this article are merely an initial step in this direction. A wide range of professions collectively influence the form and function of parking lots, including engineers, hydrologists, landscape architects, urban foresters, soil scientists, developers, leasing agents, plan reviewers, transportation researchers and many, many others. Working together, these groups can move us closer toward the goal of a truly sustainable parking lot, i.e., one that not only provides car habitat, but also prevents damage to other habitats, as well. - JAZ

## References

- Center for Watershed Protection. 1998a. *Better Site Design: A Handbook for Changing Development Rules in Your Community*. Site Planning Roundtable. Ellicott City, MD. 176 pp.
- Center for Watershed Protection. 1998b. *Nutrient Loading From Conventional and Innovative Site Development*. Chesapeake Research Consortium. Ellicott City, MD. 56 pp.
- Interlocking Concrete Pavement Institute. 2000. *Permeable Interlocking Concrete Pavements: Selection, Design, Construction and Maintenance*. Washington, DC.
- Scott, Klaus I., James R. Simpson, and E. Gregory McPherson. 1999. "Effects of Tree Cover on Parking Lot Microclimate and Vehicle Emissions." *Journal of Arboriculture* 25(3):129-142.
- Urban Land Institute. 1999. *Parking Requirements for Shopping Centers: Summary Recommendations and Research Study Reports*. 2nd Edition. Washington, DC. 81 pp.

R0079737

# Changing Development Rules in Your Community

**W**ith urbanization, the composition of the landscape dramatically shifts away from forests, meadows, pastures, crop lands, and wetlands to hard, impervious surfaces such as roads, roofs, parking lots, sidewalks, and driveways. Numerous watershed studies have documented the negative impact that impervious cover has on the quality of aquatic systems. Consequently, communities striving for sustainable development (i.e., economic growth that also protects local streams and habitat) are faced with a difficult challenge.

Communities often find that their existing development codes and ordinances conflict with the goal of sustainable development. Many local codes and ordinances require excessive impervious cover in the form of wide streets, expansive parking lots, and large-lot subdivisions, making preservation of the natural environment difficult. In addition, the economic incentives for developers to conserve natural areas are generally few and far between.

Many communities are choosing to reevaluate their local codes and ordinances with the goal of sustainable development in mind. One of the most effective ways of reforming development rules is through a local site planning roundtable. A local site planning roundtable brings together a diverse cross-section of key players from the local government, development, and environmental communities. Though a consensus process, these stakeholders can hammer out the development rules best suited to achieving sustainable development in the context of local conditions.

When assembling the roundtable membership, it is particularly important to get every local agency with development review authority to actively participate in the roundtable process. It is equally important to involve elected officials in the process, as they must ultimately vote to adopt the proposed changes. Table 1 lists potential members of a local site planning roundtable.

The primary tasks of the local roundtable are to identify existing development rules, compare them to the principles of better site design, determine if changes can or should be made to current codes and ordinances, and finally, negotiate and reach consensus on what the changes should be. To facilitate this analysis, the Center has developed a Codes and Ordinances Worksheet (COW) to help communities evaluate their development rules in the context of better site design principles.

### Anatomy of a COW

The COW allows communities to systematically compare their local development rules to the better site design principles discussed in the first feature article. The COW asks specific questions to elicit basic information about how development actually happens in the community, and can be thought of as an "audit" of the existing codes and ordinances.

The COW uses a scoring system to measure a community's general ability to support environmentally sensitive development, with points assigned based on how well current community development rules support the principles of better site design. Point



**Table 1: Potential Members of a Local Site Planning Roundtable.**

• Planning Agency or Commission	• Engineering Consultants
• Department of Public Works	• Homeowner Associations
• Road or Highway Department	• Chamber of Commerce
• Developers	• Elected Officials
• Land Trusts	• Urban Forester
• Realtors	• Site Plan Reviewer
• Real Estate Lenders	• Stormwater Management Authority
• Civic Associations	• Municipal Insurance
• Fire Official	• Watershed Advocates
• Health Department	• Residents/and Owners
• Land Use Lawyers	

**R0079738**

allocation is somewhat subjective, and can be modified for each community based on any pressing issues facing the local government. For example, if stream protection is more of a community focus, then the value of buffers might be more heavily weighted. The total number of points possible is 100, with heaviest emphasis placed on development rules that directly relate to minimizing the amount of impervious cover.

### Getting Ready to Take the Test

The development process is usually shaped by a complex labyrinth of regulations, criteria, and approvals. Before the COW worksheet can be completed, roundtable members need to wade through this maze of paperwork and assemble all local development rules currently in place. As few communities include all of their development rules in a single document, a list of potential documents to scout for is provided in Table 2. Keep in mind that the information on a particular development rule may not always be found in a code or regulation, and may be hidden in supporting design manuals, review checklists, guidance documents or construction specifications. Be prepared to contact regional, state, and federal agencies to obtain copies of the needed documents, as well.

The next step is to identify all the local, state, and federal authorities that actually administer or enforce these rules within the jurisdiction. A team approach to this task is often helpful, using the expertise of various disciplines involved in the development process (e.g., local plan reviewers, land planners, land use attorneys, and civil engineers).

### Taking the Test

Once current rules and administering authorities have been identified, roundtable members are ready to "take the test" and see how local development rules measure up against the better site design principles.

The COW consists of a series of 66 questions that correspond to the principles of better site design (see article 45). Each question focuses on a specific site design practice, such as the minimum diameter of cul-de-sacs, the minimum width of streets, or the minimum parking ratio for a certain land use. If the local development rule agrees with the better site planning principle applicable to a particular practice, points are awarded.

In some instances, local codes and ordinances might not explicitly address a particular practice. In these cases, roundtable members should use appropriate judgement based on standard community practices.

### Calculating the Score

Once the COW has been completed, the points are totaled. Generally, a score less than 80 means that local codes should be amended in order to achieve sustainable development. The scoring ranges presented in Table 3

**Table 2: Key Local Documents Needed to Complete the COW**

Zoning Ordinance
Subdivision Codes
Street Standards or Road Design Manual
Parking Requirements
Building and Fire Regulations/Standards
Stormwater Management or Drainage Criteria
Buffer or Floodplain Regulations
Septic/Sanitary Sewer Regulations
Environmental Regulations
Tree Protection or Landscaping Ordinance
Erosion and Sediment Control Ordinances
Public Fire Defense Masterplans
Grading Ordinance

can help determine where a community's score falls in relation to the better site design principles.

With COW results in hand, roundtable members can focus discussion on specific local conditions in need of improvement. Where environmentally sensitive development rules exist, it may be helpful to assess whether they are actually implemented within the community. For example, the development rules may allow for vegetated islands within cul-de-sacs, yet they may rarely be incorporated into actual subdivision designs. Similarly, if local review agencies typically require certain environmentally sensitive standards that are not explicitly stated in the local codes, it may be a good idea to amend the codes to reflect the current practice.

It should be expected that a roundtable will need to meet many times over the course of a year to come to agreement on the changes that need to be made to the maze of codes, engineering standards, guidelines, regulations, and ordinances that collectively shape local development. The challenge is in ironing out the technical details and packaging the changes in a manner that is easy to present and understand. Furthermore, while amending local codes and ordinances is an integral first step towards achieving sustainable development, the next challenge is to ensure that better site design practices are widely implemented. This may require that local governments provide incentives and, if necessary, requirements to spur developers into innovative ways of planning, designing, and building.

### Does the Process Work?

The COW was tested out in the field when the Center recently facilitated a local site planning roundtable in the fast-growing community of Frederick County, Maryland (FCSPR, 1999). Frederick County was an ideal candidate for implementation of the local

site planning roundtable process, due in part to the rapid pace of growth in the county (approximately 22% since 1990). With large areas of undeveloped land still remaining in the area, growth management and the cost of services are current pressing issues in the county. Furthermore, the county was already planning to revisit its local subdivision and zoning codes.

The Center, in cooperation with the Frederick County Planning and Zoning and Public Works staff, recruited a diverse group of about 40 individuals to participate in the roundtable. To jumpstart the process, the Center conducted an audit of local subdivision and zoning codes using the COW worksheet. The County scored a 65 out of 100. Because there were several areas that warranted review, the roundtable membership split into three groups based on the three major better site design categories: streets and parking, lot development, and conservation areas.

The roundtable met six times over the course of a year, and ultimately adopted a set of 65 specific recommendations that were presented to the Frederick County Planning Commission and County Commissioners in February 2000. It is anticipated that it will take another year for the County to go through the laborious process of updating local codes to reflect approved changes; however, this is a relatively short period of time given the significance of the task at hand.

The Frederick County experience demonstrated that, with appropriate planning and willing and open-minded participants, the site planning roundtable process can effectively address and resolve difficult local development issues. The Center was encouraged to find that while a handful of issues were hotly debated, there was general agreement that the development process should be modified to better protect and enhance natural resources.

### Advancing the Process

The Center has received COW scores from several other communities that have "taken the test." On average, scores are in the low sixties, with totals ranging from about 50 to 70. There is significant interest among these and other communities in the Chesapeake Bay region in embarking on local site planning roundtables. The major challenge facing these communities is a lack of funding. However, several counties in central Virginia have recently obtained funding to pursue local roundtables. - *EWB*

### References

- Center for Watershed Protection (CWP). 1998. *Better Site Design: A Handbook for Changing Development Rules in Your Community*. Ellicott City, MD. 174 pp.
- Frederick County Site Planning Roundtable (FCSPR). 1999. *Recommended Model Development Principles for Frederick County, MD - A Consensus Agreement*. Center for Watershed Protection, Ellicott City, MD. 20 pp.

**Note:** A full version of the COW worksheet can be found in *Better Site Design*, CWP, 1998.



**Table 3: Assessment of COW Scoring Ranges**

Score	Assessment
90 - 100	Community has above average provisions in its codes and ordinances that promote the protection of streams, lakes, and estuaries.
80 - 89	Local development rules are good, but could use minor adjustments or revisions in some areas.
79 - 70	Opportunities exist to improve development rules. Consider creating a site planning roundtable.
60 - 69	Development rules are likely inadequate to protect local aquatic resources. A site planning roundtable would be very useful.
less than 60	Development rules definitely are not environmentally friendly. Serious reform of the development rules is needed.

# The Economics of Urban Sprawl

**S**prawl simply happens. In our time, it has become a ubiquitous feature of our nation's landscape. Low-density suburban development has inexorably crept across the rural landscape, steadily transforming farms, forests and fields into residential subdivisions, strip shopping centers and roads. In just a few decades, growing communities find that dozens of square miles of rural land have been converted into impervious cover and turf. At the same time, residents discover that roads are congested, schools are overcrowded, and the sense of place that originally attracted them has diminished.

Urban sprawl is also increasingly recognized as a primary factor reducing the quality of streams, lakes and wetlands in many watersheds. A growing body of research clearly documents that the creation of impervious cover accompanying new growth causes a predictable and profound decline in critical elements of

aquatic ecosystems (see article 1). What is most disturbing about this research is that impacts start to occur at a relatively low level of impervious cover—about 10%. To put this number in perspective, it's roughly equivalent to the amount of impervious cover produced by large-lot residential development.

An implication of this research is that sprawl is not only likely to degrade the quality of individual watersheds, but is also likely to degrade a larger number of watersheds than a more compact development pattern. A defining feature of sprawl is that it spreads out development over a much wider area than would otherwise occur. The potential effect of sprawl on a region's watersheds is illustrated in Figure 1, which compares a dispersed sprawl pattern with a more compact development form.

Planners have been proposing more compact growth patterns for many years. Regional plans for "smart

**6**

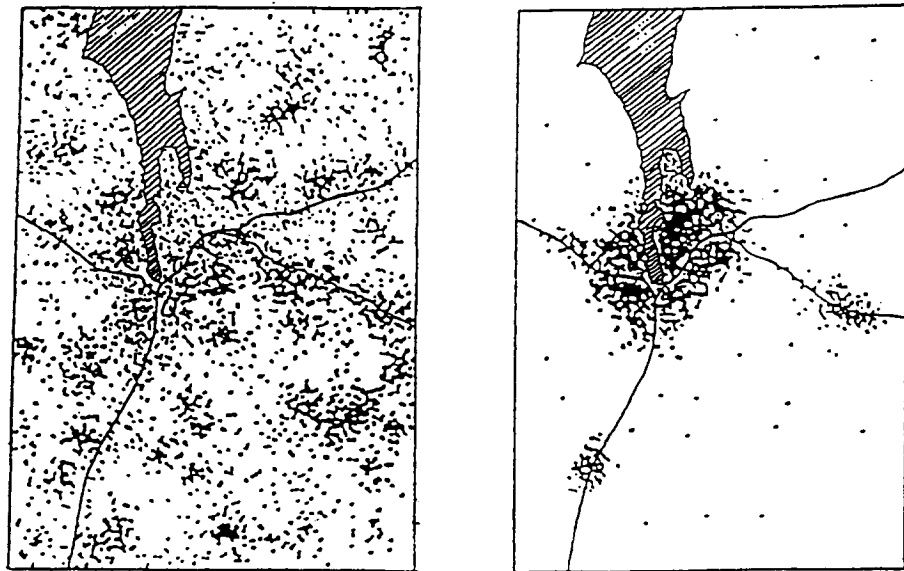

*The left panel shows the dispersed pattern of low-density sprawl, while the right panel shows a more compact development pattern concentrated in existing growth centers. At a regional scale, compact development produces less impervious cover, and subjects fewer watersheds to possible degradation.*

**Figure 1: Dispersed Versus Compact Development at a Regional Scale (Wells, 1994)**



growth" have been forged to respond to the problems of sprawl by concentrating new growth around existing development centers or regions served by suburban transit. By accommodating growth, strategically compact development can preserve prime agricultural land and sensitive natural areas while also reducing costly construction of new infrastructure. Burchell and Listokin (1995) have defined planned growth as "an attempt to maximize development resources and limit costs by containing most growth within locations that are more efficient to service."

While few people celebrate sprawl, many perceive that its unpleasant side effects are compensated by the economic growth that it creates. This may help to explain why sprawl patterns persist despite thousands of studies, meetings, commissions and conferences that have tried to manage, control, redirect or eliminate it. In this article, we review the economics of sprawl development, and critically examine the conventional wisdom about its effect on the local economy, government budgets, land property values, and the community at large.

### Impact on the Local Economy

A healthy regional economy is an interconnected web built on diversification, with each sector relying on the others in the system. Just as the environmental effects of sprawl development can be felt throughout the ecological system, so too are the economic effects of sprawl felt throughout the economy. These detrimental effects may be masked temporarily in a "hot" real estate market, but in all likelihood they will eventually emerge.

Because sprawl development has adverse impacts on traditional local industries such as agriculture, fisheries, forestry and tourism, it can weaken economic diversity in the overall regional economy. For example, low density sprawl is projected to result in the fragmentation and loss of 12% of agricultural land in California which, in turn, will reduce the value of agricultural products grown in the Central Valley by \$2.1 billion annually by the year 2040. "That would be the equivalent of wiping out the entire agricultural production of New York, Virginia, Oregon, or Mississippi," according to American Farmland Trust (1995). The indirect loss of sales to businesses such as fertilizer and equipment suppliers and food processors would reach about \$3.2 billion a year. The loss in income for growers and workers would amount to \$2.7 billion over the same period. The American Farmland Trust (AFT) study concludes that managed growth could save Central Valley agriculture revenues of about \$72 billion by the year 2040.

The consequences of activity by agriculture, tourism and other local industries are felt in the economy through what are termed *multiplier effects*. Multiplier

effects can be described as the increased buying power of a dollar as it moves through the economy. There are different multipliers for various market sectors and regions of the country. Generally speaking, however, each dollar spent by a tourist will create as much as \$1.50 as it moves through the local economy. This increased purchasing power of money spent in a market sector can have a dramatic effect locally, particularly if one sector of the economy is suddenly lost. The loss of the fishing industry, for example, can be felt in other closely allied sectors of the local economy such as boat building and marine supplies, but the effects ripple through other sectors as diverse as grocery stores and personal service providers.

### Impact of Sprawl on Local Government Budgets

One assumption about sprawl is that by promoting residential development, local tax revenues are increased, which ultimately lowers everyone's property taxes. Although new development certainly increases the local tax base of the community, new homes and businesses also increase the cost of municipal services: roads, schools, sewage treatment, water supply, fire services, libraries, and parks and recreation. Sprawl development traditionally brings both residential and commercial development. Residential development is usually a tax negative, as single-family detached homes cannot pay their full way for services. While commercial development can be an initial tax positive, it tends to attract more residential development as people move to homes closer to where the jobs are located.

Several reasons explain why sprawl development increases the cost of services. Since sprawl development is located away from established centers, new homes and businesses cannot utilize existing services and infrastructure. New infrastructure must be built, often over longer distances. This means more miles of roads, sewers and water lines are needed, driving up service costs. Large-lot development means fewer taxpayers support higher infrastructure costs per household. In addition, more and smaller sewage plants, schools, libraries and other improvements are often built to serve the new, spread-out, low-density communities. Such inefficiencies lead to higher costs to treat a gallon of sewage or educate a student (Burchell and Listokin, 1995).

A number of economic studies have detailed the differences between sprawl and compact growth patterns (Duncan *et al.*, 1989; Frank, 1989; Burchell, 1992). These studies have compared costs for suburban "sprawl" versus more dense, mixed-use growth. While both growth patterns typically result in the same number of people and jobs, compact growth protects a greater share of farmland, forests and natural areas. Together, the three studies show that planned develop



ment consumes about 45% less land, costs 25% less for roads, 15% less for utilities, 5% less for housing, and 2% less for other fiscal impacts (Burchell and Listokin, 1995).

When translated into absolute dollars, these savings are significant. As one example, Burchell (1992) found that the state of New Jersey could save \$1.4 billion (in 1992 dollars) over 20 years by encouraging compact growth rather than allowing current sprawl to continue.

Another way to express the costs of sprawl is to examine the cost of providing service to a single dwelling unit. Frank's 1989 study reviewed 40 years of fiscal impact studies, and found that it costs two to three times more to service homes in low-density developments located far from public service centers (Table 1).

When public services are extended out to new developments, funds must be raised for the infrastructure through increased property taxes, impact fees, or other means. According to Brett Hulseley (1996), Wisconsin towns estimate that each \$1 million in new residential construction costs adds \$30 to each property tax bill to pay for more police, fire, sewer, schools and other services. In another Wisconsin town, it was estimated that it costs taxpayers \$1,060 to service new residential development, compared to each \$1,000 the new owners will pay in tax revenue.

In Culpeper County, Virginia, a 1988 study concluded that an "average new residential unit can be expected to produce a deficit in the county budget of \$1,242—an annual 'bottom line' negative balance of capital and operating expenditures over revenues" (Vance and Larson, 1988). In addition, tax bills for all residents in the county would need to rise by as much as 80% to offset the costs of new developments. In Prince William County, Virginia, another fast-growing bedroom community, officials estimate the costs of providing public services to a new residential home exceeds what is brought in from taxes and other fees by \$1,600 per home (Shear and Casey, 1996).

Unlike residential development, farms, forests, open space and commercial development provide a net tax benefit to the community. Studies across the East and Midwest have analyzed the costs of servicing various land uses (Vance and Larson, 1988; AFT, 1994 and 1992;

Hulseley, 1996). On average, these studies show that public services cost only 32% of taxes received for commercial development, and 37% of taxes received for agricultural, forest and open space. This is why it makes sense to pay farmers for development rights so that they can continue farming and the community can keep its property tax rate down. Table 2 shows the costs of services as a percentage of taxes received from three different land uses in 10 communities.

#### Impact of Sprawl on the Landowners and Homebuyers

Sprawl also has economic consequences for individual property owners. Two groups need to be considered in discussing the effects of sprawl on property owners: those already owning property and home buyers seeking affordable homes. Sprawl development eventually increases local property taxes in order to meet increased demand for services. This results in higher taxes for existing property owners who can least afford it: the poor and elderly residents on fixed incomes. In some communities, the higher property taxes can displace long-term residents.

Sprawl development also tends to drive up the cost of new homes, since more infrastructure needs to be constructed for each unit. The needed infrastructure includes increased costs for longer roads, storm sewers, sewer and water lines, and other utilities. In most subdivisions, infrastructure service costs can amount to half the total cost of development (CH2M-Hill, 1993). Since infrastructure costs incurred by the developer are often directly passed along to the homebuyers in the form of a higher sales price, this can reduce the supply of affordable housing. In addition, sprawl development increases impervious cover, generating more runoff, and consequently higher costs for storm drainage and treatment systems. The higher cost to build large-lot development is usually counterbalanced by the much lower cost of land at the suburban edge. Indeed, the price and supply of low-cost land are often the prime engine driving sprawl development patterns.

Still, there is a strong market for low-density residential development. Many home buyers do have a deeply rooted preference for suburban housing patterns that can accommodate their mobile lifestyle. Market surveys

**Table 1: Comparison of Capital Cost of Services for a Single Dwelling Unit (Frank, 1989)**

Development Pattern	Capital Cost (1987 Dollars)
Compact growth	\$18,000
Low-density sprawl	\$35,000
Low-density sprawl, 10 miles from existing development	\$48,000

6

**Table 2: Cost of Servicing Different Land Uses As a Percentage of Tax Revenue Received**

Study Location	Residential Development	Commercial Development	Farmland, forest, and open space
Culpeper County, VA <sup>a</sup>	125 %	19 %	19 %
Connecticut average <sup>b</sup>	106	47	43
Massachusetts average <sup>b</sup>	112	42	33
New York average <sup>b</sup>	124	24	35
Town of Dunn, WI <sup>c</sup>	106	29	18
Lake Elmo, MN <sup>d</sup>	107	20	27
Independence, MN <sup>d</sup>	103	19	47
Farmington, MN <sup>d</sup>	102	79	77
Madison, OH <sup>d</sup>	167	20	38
Madison Township, OH <sup>d</sup>	114	25	30
<b>Average</b>	<b>116 %</b>	<b>32 %</b>	<b>37 %</b>

Sources: <sup>a</sup>Vance and Larsen, 1988 <sup>b</sup>American Farmland Trust, 1992 <sup>c</sup>Hulse, 1996 <sup>d</sup>American Farmland Trust, 1994

have consistently shown that consumers prefer residential subdivisions to denser, mixed-use choices. Two surveys by *Builder* and *Professional Builder* magazines indicated a majority of new home buyers preferred less dense and more homogenous development patterns to denser ones. A Florida study found that over two-thirds of 1,400 households surveyed preferred detached suburban lots to townhouses located closer to the urban core, even when this choice was directly linked to longer commutes and driving times (Bookout, 1992).

While consumers do prefer the suburbs, this does not necessarily imply they are satisfied with conventional large-lot subdivisions. Developers have found well-designed cluster and traditional urban-style neighborhoods are very attractive to new home buyers. In addition, surveys have shown that residents will pay a premium to live next to natural areas or in a park-like setting, as described in detail in article 30. Finally, as environmental awareness has grown among consumers, the market for environmentally-friendly compact developments has expanded. Recent market surveys have tracked the ascendance of this preference for "green development."

#### **Sprawl and the Environment**

As noted earlier, watersheds are particularly vulnerable to the impacts of sprawl. Even though sprawl produces relatively little impervious cover, it has a profound influence on stream ecosystems.

The rapid and striking decline in stream quality that can occur in a single generation of sprawl development is illustrated in a recent analysis of 1,300 stream miles in the Occoquan Basin (Schueler and Claytor, 1997). By tracking changes in subwatershed impervious cover, it was possible to forecast the shifts in stream quality as a result of past and future development patterns (Figure 2). As can be seen, streams classified as sensitive (zero to 10% impervious cover) declined from 60% of total stream miles in 1989 to a total of only 19% by the year 2020. In contrast, "non-supporting" streams (defined as having poor biological diversity, channel instability and high bacteria levels) grew from a mere 9% in 1989 to a projected 39% in the year 2020.

Sprawl also degrades the quality of the rural landscape by fragmenting fields, forests and wetland habitats. This can produce a loss in tourism income, as land rentals for hunting, fishing, recreation and other tourism activities all diminish.

Communities may be required to expend significant sums to repair or restore habitat degraded by sprawl. For example, the cost of restoring degraded water quality and habitat in the Anacostia watershed is estimated at \$400 to \$1,600 per acre and will require two decades, without any assurance that it can ever be completely restored (Schueler, 1995). Many coastal communities in New England that had not effectively regulated sprawl development in the past are now finding that the costs of efforts to reopen shellfish beds are very high, and have limited success.



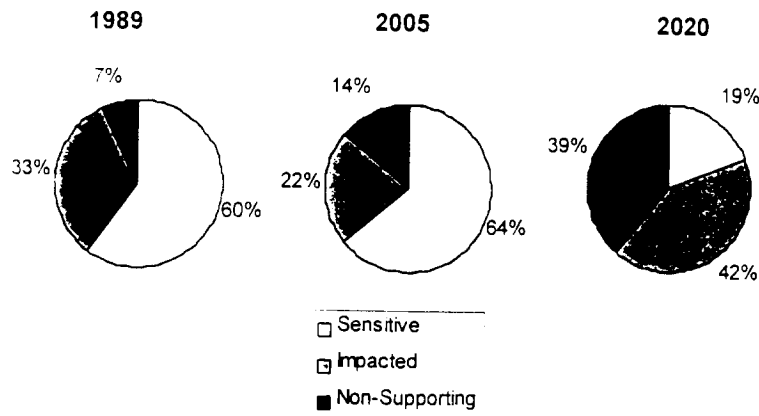

Stream quality classification is projected to decline in the Occoquan Basin as imperviousness increases from 1989 to 2020.

**Figure 2: Projected Stream Quality in the Occoquan Basin (Schueler and Claytor, 1997)**

#### Impact on the Community

Sprawl can also lead to a reduced quality of life for local residents. As a Bank of America study points out, sprawl leads to higher costs for businesses and leaves workers caught in long and exhausting commutes. It plays a strong role in air quality problems, severe farmland loss, and "abandonment of people and investments in older communities." Critics of sprawl (Lincoln Institute of Land Policy, 1995) have described a number of its negative social consequences:

- Poverty is concentrated in dense urban areas (setting the stage for decline and loss of future economic development opportunities).
- Society is resegregated along economic and racial lines, creating disparities through residential patterns that produce unequal access to education and other services.
- Public investment in schools, public safety, and mass transit systems becomes unfeasible.
- Increased automobile dependence undermines or nullifies efforts to improve air and water quality and to conserve energy.

#### The Balance Sheet: Sprawl as an Economic Drain

The economic and environmental impacts of sprawl are summarized in the "balance sheet" in Table 3. After several decades of study, it is apparent that sprawl development imposes significant short-term and long-term costs on local government, business, property owners, developers and the environment.

Of course, sprawl won't disappear just because it doesn't make a lot of economic sense. Indeed, prior zoning has often granted development rights over much of the countryside, leaving local communities with few tools to prevent sprawl from gradually unfolding. These tools include designation of growth boundaries, farmland preservation and targeting of new public infrastructure investments. The last tool is growing in popularity, as state and local governments are electing to spend scarce funds on new roads, sewers, and other infrastructure only within existing developed areas or specially designated growth areas. More communities now recognize that public investments should be spent to contain sprawl rather than promote it. Educating the public and their elected officials about the economic and environmental consequences of sprawl is a first step toward better local choices about growth management.

-JP

#### References

- American Farmland Trust. 1992. *Does Farmland Protection Pay? The Cost of Community Services in Three Massachusetts Towns*. Massachusetts Department of Food and Agriculture. Lancaster, MA. 38 pp.
- American Farmland Trust. 1994. *Farmland and the Taxbill: the Cost of Community Services in Three Minnesota Cities*. American Farmland Trust. Washington, D.C. 20 pp.
- American Farmland Trust. 1995. *Alternatives for Future Urban Growth in California's Central Valley: the Bottom Line for Agriculture and Taxpayers*. American Farmland Trust. Washington, D.C. 129 pp.
- Audirac, I., and M. Zifou. 1989. *Urban Development Issues: What is Controversial in Urban Sprawl? An Annotated Bibliography of Often Overlooked Sources*. CPL Bibliography 247. Council of Planning Libraries. Chicago, IL.
- Bank of America, California Resources Agency, Greenbelt Alliance, the Low Income Housing Fund. 1995. *Beyond Sprawl: New Patterns of Growth to Fit the New California*. Bank of America. San Francisco, CA. 11 pp.
- Bookout, L. W. 1992. "Neotraditional Town Planning: The Test of the Marketplace." *Urban Land* June 1992. pp. 12-17.
- Burchell, R. W. 1992. *Impact Assessment of the New Jersey Interim State Development and Redevelopment Plan, Report II and III*. Report prepared for New Jersey Office of State Planning, Trenton. February 20 and April 30. (Executive Summary). 28 pp.

**Table 3: The Balance Sheet—Economic and Environmental Impacts of Sprawl Development**

Economic Player	Positive Impacts	Negative Impacts
Local Government	(+) Increased property tax revenues	(-) Increased demand/cost for services (-) Residential development doesn't pay for itself
Local Economy	(+) Increase in building/service sectors	(-) Decline in farm, fishery and/or forest sectors
Existing Property Owners	None	(-) Higher property taxes (-) Greater traffic congestion (-) Conflicting land uses
New Home Buyers	(+) Affordable housing (only if land costs are low)	(-) Higher property taxes (-) Higher infrastructure costs for new homes
Environment	None	(-) Degradation of water resources including wetlands (-) Decline in air quality (-) Fragmentation of green space (-) Higher costs for environmental restoration (-) Creation of high input turf
Developer	(+) Land costs are lower (+) Developer has complete choice where to build and less restrictions on size and scale of development	(-) Construction costs inflated by local codes (-) Higher costs for stormwater/wastewater treatment

Burchell, R. W. and D. Listokin. 1995. *Land, Infrastructure, Housing Costs and Fiscal Impacts Associated with Growth: The Literature on the Impacts of Sprawl Versus Managed Growth*. Lincoln Institute of Land Policy. Cambridge, MA. 25 pp.

CH2M-Hill. 1993. *Costs of Providing Government Services to Alternative Residential Patterns*. Committee on Population Growth and Development. U.S. EPA Chesapeake Bay Program. Annapolis, MD. 168 pp.

Duncan, J. et al. 1989. *The Search for Efficient Urban Growth Patterns*. Florida Department of Community Affairs. Tallahassee, FL.

Frank, J. 1989. *The Costs of Alternative Development Patterns: A Review of the Literature*. The Urban Land Institute. Washington, D.C. 46 pp.

Hulsey, B. 1996. *Sprawl Costs Us All: How Uncontrolled Sprawl Increases Your Property Taxes and Threatens Your Quality of Life*. Sierra Club Midwest Office. Madison, WI. 18 pp.

Lincoln Institute of Land Policy. 1995. *Alternatives to Sprawl*. Lincoln Institute of Land Policy. Cambridge, MA. 32 pp.

Schueler, T. 1994. "The Importance of Imperviousness." *Watershed Protection Techniques* 1(3): 100-111.

Schueler, T. 1995. *Site Planning for Urban Stream Protection*. Center for Watershed Protection. Metropolitan Washington Council of Governments. Silver Spring, MD. 222 pp.

Schueler, T., and R. Claytor. 1997. "Impervious Cover as an Urban Stream Indicator and a Watershed Management Tool." *Effects of Watershed Development and Management on Aquatic Ecosystems*. American Society of Civil Engineers. New York, NY. pp. 513-529.

Shear M. D., and W. Casey. 1996. "Just Saying 'Yes' to Developers." *The Washington Post*, June 21, 1996.

Vance, T., and A. Larson. 1988. *Fiscal Impact of Major Land Uses in Culpepper County, Virginia*. Piedmont Environmental Council.

Wells, C. 1994. *Impervious Surface Reduction Study: Technical and Policy Analysis*. City of Olympia, WA. 144 pp.



# Skinny Streets and One-sided Sidewalks A Strategy for Not Paving Paradise

*Cedar Wells, City of Olympia, WA*

**S**tormwater policies and regulations aim to reduce the hydrological, water quality, and habitat impacts of stormwater runoff, but fail to directly address the source of the problem: parking lots, streets, compacted soils, and other impervious surfaces. Given their land use and permitting authority, local governments in the fast-growing Pacific Northwest and elsewhere can reduce the amount of impervious surfaces, increase groundwater recharge, and protect fish and wildlife habitat.

Results of the City of Olympia's two-year Impervious Surface Reduction Study (ISRS) indicate that a 10 to 20% reduction in impervious surfaces associated with new development is a reasonable goal. Impervious surface reduction also complements and challenges other public goals such as fire vehicle access, growth management, automobile trip reduction, and accommodating physically disabled citizens. The cross-goal aspect of impervious surface reduction offers an opportunity to reduce regulatory inconsistencies and complements comprehensive land use planning. However, broad-based public discussion is key to realizing multiple goals.

Obvious techniques such as narrower streets, clustering, and decreased land clearing can be implemented if incentives are provided and barriers removed. To identify feasible and practical reduction strategies, the City of Olympia involved the business and development community, neighborhood associations, decision-makers, and local government staff. Over 50 people were directly involved in developing study recommendations. Committees, displays, presentations and briefings, slide shows, fact sheets, and direct surveys also were used to involve and educate the community. The study recommendations are based on an evaluation of costs, benefits, sustainability criteria, and implications for water resources management.

It's expected that immediate implementation of the recommendations in Olympia, the surrounding North Thurston County Urban Growth Management Area (UGMA), and other locations will provide some land use options for local jurisdictions. It is anticipated that the recommendations will result in approximately 1,157 acres less impervious surface when the 84 square mile North Thurston UGMA is built out in the year 2012. This undeveloped acreage can be filled in with additional development such as offices or houses, or dedicated to

open space, parks, or other amenities. Filling in the area with additional development may serve as a density credit incentive for the development community to implement the study's recommendations. The resulting infill should help reduce urban sprawl and contribute to a regional per capita reduction in impervious surfaces.

Implementation of the ISRS recommendations also will delay the inevitable build out of the UGMA. The area's estimated build out could be delayed by six years if a 20% reduction in new development impervious surfaces is achieved. These six years can be used for groundwater research and development of new technologies, and will delay the irreversible changes in soils and hydrological relationships caused by impervious surfaces.

Final products of the study include implementation strategies, evaluation techniques, community involvement, and technical assistance materials. The products are tailored toward Olympia and the North Thurston County UGMA, but are applicable to other settings. Some simple but effective reduction strategies for local jurisdictions everywhere are shown in Figures 1 and 2 and include the following:

- Integrate impervious surface reduction into local policies, goals, and regulations, especially street and parking regulations.
- Reduce the size of parking areas:
  - (1) Encourage cooperative parking (e.g., park n' rides, shared parking) by allowing such arrangements and providing model legal agreements.
  - (2) Require exploration of cooperative parking and transportation demand management options before allowing excess parking.
  - (3) Develop parking standards that reflect average parking needs instead of single peak day (e.g., Christmas Eve) projections.
  - (4) Build multi-story parking structures or under the building parking.
- Reduce street coverage:
  - (1) Reduce residential (local access) street widths.
  - (2) Retrofit existing cul-de-sacs with vegetated islands designed to hold stormwater.

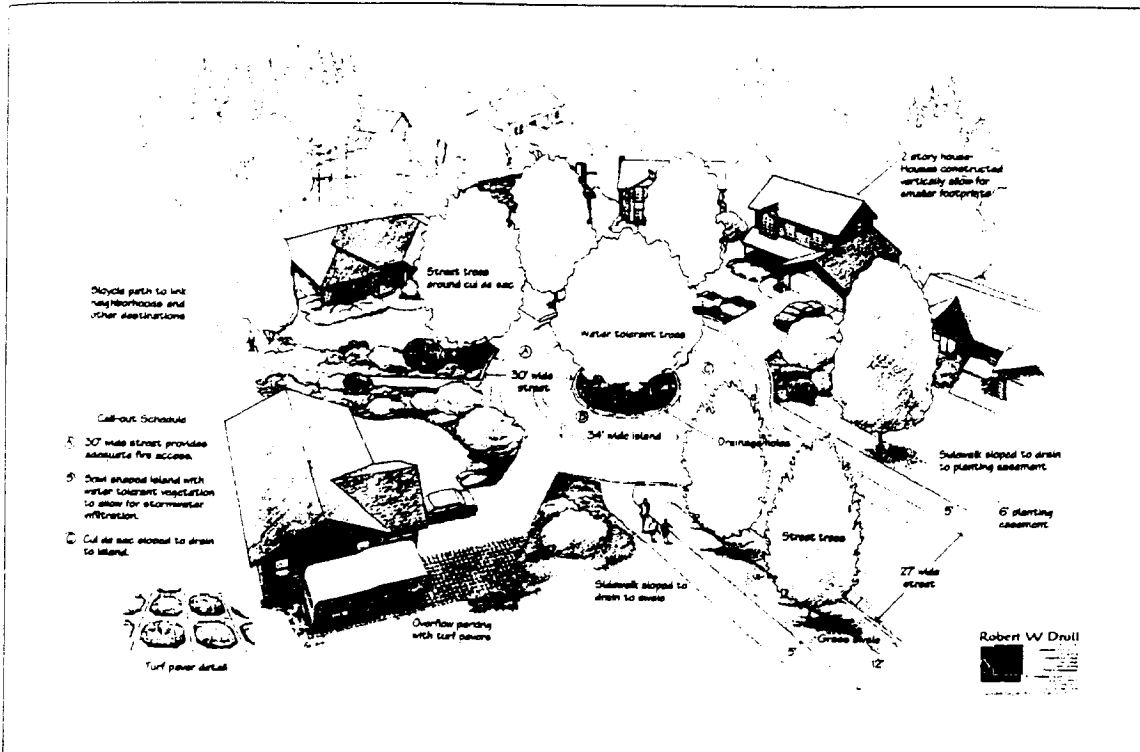

Figure 1: Strategies for Impervious Cover Reduction in Residential Areas (Wells, 1995)

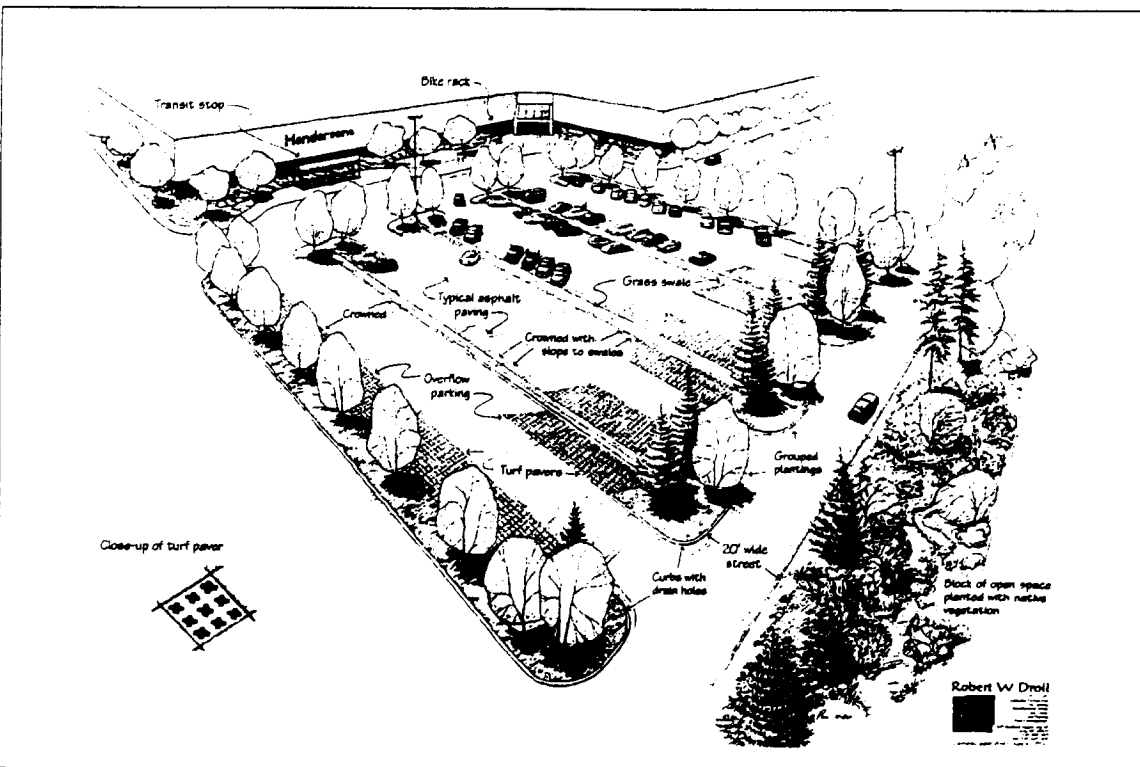

Figure 2: Strategies for Impervious Cover Reduction in Commercial Areas (Wells, 1995)

- Narrow sidewalks:
  - (1) Narrow low-use sidewalks to at least four feet in width.
  - (2) Build sidewalks on only one side of the street.
  - (3) Slope sidewalks to drain to vegetated swales or gravel strips.
- Design and locate buildings more effectively:
  - (1) Encourage cluster development that minimizes impervious surfaces
  - (2) Build and use taller buildings, and modify policies to allow taller buildings.

#### Reference

Wells, Cedar. 1995. *Impervious Surface Reduction Study: Final Report*. City of Olympia Public Works Department. Olympia, WA.



# Use of Open Space Design to Protect Watersheds

**C**lustering refers to a compact pattern of development at a site, also known as open space design. Clustering is not a new idea. It has been utilized for several decades in many communities around the country. Most of these cluster programs, however, were developed to meet general environmental, architectural or community objectives and were not designed explicitly for watershed protection.

Clustering does have a strong potential to reduce the total imperviousness of a site, fully protect all environmentally sensitive areas, and provide additional open and green space within a community. It works in a simple manner. A greater density of homes or structures on one portion of the site is traded for open space elsewhere on the site. The higher density is achieved by giving the designer more flexibility in reducing the size and geometry of individual lots than is normally allowed under subdivision codes.

Conventional subdivision codes contain rigid requirements that govern the minimum area of a lot, setbacks from the front, side and rear property lines, as well as minimum frontage requirements (mandatory width of the front yard) (Table 1). Together these requirements increase the distance between lots. Because the length of roads, sidewalks and other impervious surfaces is directly related to the distance between lots, a greater distance translates into more impervious cover.

When designed properly, cluster development can reduce site imperviousness by 10 to 50%, depending on the original lot size and road network. Some of the other benefits of cluster development are outlined in Table 2.

Communities have gained considerable experience in the use of cluster development over the past two decades. Our most detailed knowledge about local cluster programs is drawn from a national survey of 39 programs conducted by Heraty (1992). The responses from a wide cross-section of planners suggest that many current cluster programs may require significant modification if they are to achieve effective nonpoint source control. Some of Heraty's key findings include the following:

*1. Most local cluster programs were not designed for the purpose of protecting streams or providing non-point source control.*

Most local cluster programs were adopted for purposes unrelated to stream protection or urban nonpoint source control. Indeed, the five most frequently cited objectives for cluster programs were to achieve a greater variation in the style and design of developments (80%), protection of environmentally sensitive areas (primarily wetlands and forests, 77%), to provide community recreation areas (62%), to preserve the rural character of the landscape (51%), and to produce more affordable housing (39%). Only 18% of cluster programs were adopted as a means of reducing stormwater pollution from the site or as a technique to reduce impervious area. Most of the programs, however, acknowledged that clustering did reduce impervious cover when compared to conventional subdivisions.

*2. Required open space in clusters is often poorly designed and fragmented.*

Nearly every cluster program required that a portion of the site be retained in open space. On average, the minimum open space requirement for residential developments was one-third of total site area. However, an early problem reported by many communities, however, was the fragmentation and poor quality of the open space. In some cases, open space was poorly landscaped and widely scattered across the entire development. Consequently, the open space contributed little functional value to either the community or the environment. A third of all cluster programs now require that a minimum percentage of open space should be consolidated. The average consolidation requirement is 70% of total open space (range: 30 to 100%).

*3. Few cluster programs require that a portion of open space should be protected as green space.*

The survey reported that very few cluster programs required that any portion of open space be reserved as "green space" or undisturbed areas in native vegetative cover. Less than 10% of all programs had such a requirement. The provision of green space would greatly amplify the environmental benefit of clustering.

*4. Cluster programs rarely specify what are allowable and unallowable uses of open space.*

A great deal of variation was seen in the kinds of uses and activities that were allowed or denied within

**Table 1: Comparison of Single Family Home Dimensions for Conventional vs. Cluster Development, One-Acre Lots**

Site Factor	Detached single family residence	Detached cluster
Min. site size	5 acres	5 acres
Maximum site density	1 du/acre	1 du/acre average
Lot size	40,000 ft <sup>2</sup> min.	10,000 ft <sup>2</sup> min.
Frontage	150 ft min.	75 ft min.
Front yard	40 ft min.	25 ft min.
Side yards	25 ft min./60 ft total	10 ft min./25 ft total
Rear yard	40 ft min.	25 ft min.
Bldg. footprint	5% of lot	18% of lot
Open space required	none	33% of site min.

designated open space (Table 3). A surprising number of allowable uses created impervious cover (such as hard courts, pools, roads, bike paths). Only 14% of all programs restricted or prohibited the construction of significant impervious cover within green or open space. Most cluster programs also allowed golf courses, lawn, turf, ballfields and fill within open space. While these uses are acceptable for open space dedicated to recreation, they are certainly not the most protective use of green space. Very few cluster programs acknowledged this key distinction.

5. Cluster remains a largely voluntary development option that is not frequently exercised by the development community.

Cluster was a non-mandatory option in 95% of the local cluster programs surveyed. On average, about 37% of all new subdivisions are clustered in each program, with the remainder conventionally developed. Surprisingly, 20% of communities reported that they had yet to receive a cluster proposal since they first adopted their cluster ordinance. Other communities report from five to 100 cluster proposals per year.

A number of market factors and perceptions explain the wide variation in the number of developers that opt to cluster. The development community needs to balance the perceived economic benefits of cluster against the vagaries of the real estate market (i.e., will the clustered units sell?). After all, the conventional subdivision product has sold well over the years—will a clustered product be equally acceptable in the market? Many respondents remarked that consultants, bankers, landscape architects and developers all need to be reassured on this point before it becomes a common practice.

Overall, the actual market acceptance varies depending on the type of housing and the quality of clustering. The survey indicated that 67% of cluster program managers felt that cluster developments properties appreciated in value at an equal or greater rate than conventional subdivisions. Some 18% of respondents felt that cluster developments did not appreciate as fast as conventional subdivisions. In many cases,

**Table 2: Benefits of Cluster Development**

1. Reduces site and watershed imperviousness by 10 to 50%, depending on lot size and layout.
2. Reduces stormwater runoff and pollutant loads.
3. Reduces pressure to encroach on resource and buffer areas.
4. Reduces potential for soil erosion since green space is not cleared on up to 15% of the site.
5. Reserves up to 15% of site in green space that would not otherwise exist.
6. Reserves up to 15% of site in open space dedicated to passive or active recreation.
7. Provides partial or total compensation for lots that are lost to resource protection areas and stream buffers.
8. Reduces capital cost of development by 10 to 33%
9. Reduces the cost of future public services needed in the community.
10. Can increase future residential property values.
11. Reduces the size of stormwater quantity and quality controls.
12. Concentrates runoff where it can be most effectively treated.
13. Provides a wider range of possible sites to locate stormwater practices.
14. Creates larger urban wildlife habitat islands.
15. Increases sense of community and makes development more pedestrian friendly.
16. Can support other community planning goals such as preservation of farmland or rural landscapes, affordable housing, and architectural diversity.

this was thought to be due to the fact that the cluster development involved converting detached single family homes into attached townhouses.

From a cost standpoint, much of the development community now recognizes that clustering can save capital costs in construction, provide partial compensation for lost lots due to local, state or federal regulation, and provide greater architectural variety.

Still, local governments will need to provide more incentives to the development community, if the proportion of clustered subdivisions is to be increased from present levels. Over half of the planners acknowledged that a greater effort must be made to encourage developers to consider implementing cluster development in their community. Some of the more frequently cited incentives include an expedited review process, more flexibility in design and density, and a greater investment in education and training of consultants and landscape architects.

6. A significant fraction of new development is occurring on larger lots and is located outside existing or planned water and sewer service areas.

Local communities are discovering the need to develop new cluster models to handle the emerging patterns of development in rural areas. These trends are best exemplified in Maryland. A statewide land use survey, indicated that large lot development (one dwelling unit/acre or greater) was the fastest growing land use, and comprised about 20% of all residential development in the last decades (MOP, 1991). On an area basis, large lot development constituted over 76% of all land converted to residential use over the same period. Lastly, an astonishing 84% of residential development (mostly large lot development) occurred outside of existing or planned water and sewer service areas.

While these trends in land use certainly suggest an enormous potential for clustering, the cluster models will need to be adapted to address special problems with respect to waste disposal, water supply, drainage and roads and other concerns. A generalized model for performance criteria for cluster development is provided in Table 4. The model is intended to be conceptual, each locality will need to refine and adapt it to meet the specific dimensions for each of its residential zoning categories.

- TRS

Table 3: Allowable and Prohibited Uses of Open Space (Heraty, 1992)

Land use or activity	Allowed (%)	Prohibited (%)	Restricted (%)
Parks, including foot or bike paths	94	3	3 (RO)
Athletic Field	49	15	36 (RO)
Golf Course	67	11	22 (RO)
Hard Courts	53	12	35 (RO)
Playground	58	8	34 (RO)
Swimming Pool	50	9	41 (RO)
Impervious Surfaces	86	14	
Individual OSDS	16	78	6 (P)
Common OSDS	41	53	6 (P)
Road/Bridge	55	39	6 (P)
Utility Lines	70	18	12 (P)
Lawn or Turf	71	14	6 (P), 9 (RO)
Stormwater BMPs	65	16	14 (GS), 5 (RO)
Agriculture	29		
Community Center Bldg	14		
Trails	39		

RO, in recreational areas only; GS, only in green space; P, use is restricted, may require permit or homeowner association approval; OSDS, On-site sewage disposal

#### References

- Heraty, M. 1992. *Results of Cluster Survey*. Metropolitan Washington Council of Governments. Washington, D.C. 25 pp.
- Maryland Office of State Planning. 1989. *Environmental and Economic Impacts of Lot Size and Other Development Standards*. Baltimore, Maryland. 18 pp.
- Maryland Office of Planning. 1991. *Maryland's Land 1973-1990-A Changing Resource*. Baltimore, MD. 68 pp.

R0079752

**Table 4: Performance Criteria for Cluster Design to Protect Watersheds, Adaptable to 0.5 - 5 Acre Residential Zoning Categories**

Performance standard	Criteria
Minimum site size	5 acres
Minimum lot size	10,000 square feet
Other relaxed lot dimensions	Reduced frontage, reduced setbacks on rear, front, and side yards, expanded building footprint.
Net density	Gross density less unbuildable lands
Unbuildable lands	Includes right of ways, open water plus wetlands, steep slopes, floodplains, stream buffer, and prime woodlands.
Required open space	33% of total net site area
Consolidation	75% of open space
Green space	No less than 50% of open space
Recreation space	No more than 50% of open space
Green space uses	The vegetative target is predevelopment forest. Siting of stormwater treatment practices and common OSDS systems may be allowed.
Recreation space use restrictions	Limit creation of impervious surfaces. Ballfields, playgrounds, pools, hardcourts, bike trails and stormwater ponds permitted. Vegetative goal is to minimize extensive turf areas.



**R0079753**

# Section 7: Erosion and Sediment Control

## Watershed Protection Tool #5

**E**rosion and sediment control (ESC) seeks to prevent damage to a watershed during construction, which is potentially the most destructive stage of land development. Contractors are typically required to install a series of temporary practices at construction sites both to reduce sediment loss from exposed soils, and to prevent the clearing or disturbance of buffers, forests, stream channels and other important conservation areas at the site. A typical erosion and sediment control plan involves a sequence of measures to minimize clearing, protect waterways, stabilize drainage ways and steep slopes, and establish a grass or mulch cover on exposed soils. As a last line of defense, perimeter controls (such as silt fences) and sediment basins are installed to try to prevent sediment from leaving the site. The basic practice of erosion and sediment control is summarized in article 52, and its individual elements are evaluated in articles 53 to 59.

More than any other tool, the success of ESC relies on the judgement and diligence of the contractor, inspector and engineer. When they all do their jobs well, the outcome of an ESC program is usually good. If, on the other hand, any one of the three fails to perform his role, then a construction site can quickly become a sediment problem. Given the importance of the human factor, effective ESC programs place a premium on both training and accountability. Three articles (60 to 62) critically examine this issue.

### *Trends in Erosion and Sediment Control in the Last Decade*

Most communities now require some form of ESC during construction, and some have done so for nearly 30 years. Despite this track record, the practice of ESC has not progressed very far, and both research and innovation have lagged considerably. To be fair, a few communities have shown leadership in advancing or enforcing the general practice. But most communities have not appreciably changed their ESC practices in years, despite the fact that their construction sites still discharge muddy waters. This complacency can be explained by the fact the success or failure of ESC is usually measured by administrative indicators, rather than watershed ones. In most communities, success is solely defined in terms of plan compliance (i.e., are the practices

prescribed in the plan installed and maintained at the site). This definition of success means that it really does not matter if the practices prescribed in the plan actually prevent sediment loss from the site. Until numerical watershed indicators are used to regulate construction sites (such as a maximum sediment concentration), there is little incentive to improve the overall performance of ESC efforts. Even modest numerical standards for sediment discharge would exert a powerful force to drive better research, spark greater innovation, and sharpen the diligence and judgement of contractors.

The limited research undertaken in the last decade has generally demonstrated that sediment basins, silt fences and other sediment controls have only a modest ability to actually reduce sediment levels at real world construction sites. Given such a limited ability to remove sediments once they have been eroded, many communities have sought to prevent erosion from occurring in the first place. As a result, more communities have adopted stricter limits on clearing and grading, tree conservation, and construction phasing.

**"More than any other tool, the success of ESC relies on the judgement and diligence of the contractor, inspector and engineer."**

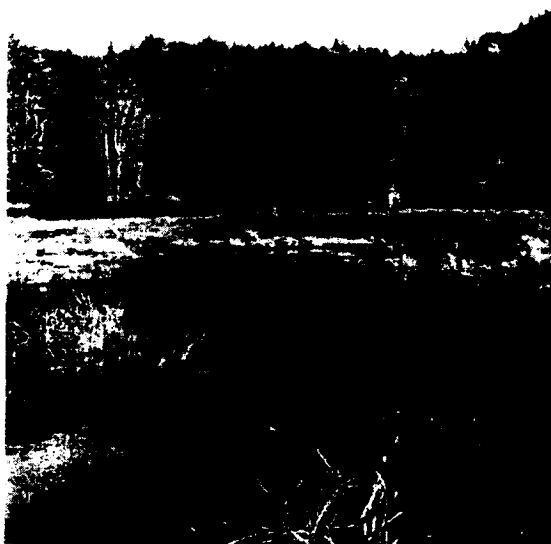

As indicated earlier, very little research has been devoted to ESC, which is remarkable when compared to the massive research investments in stormwater treatment practices. Clearly, the further advancement of ESC will depend on a large and sustained research program. While there are many critical research needs, research in three specific areas would be extremely valuable for the ESC practice. As a first priority, it is important to study the impacts of construction sites on the diversity and ecology of stream ecosystems. It is nothing short of amazing that we have no data whatsoever on the impact of suspended or deposited sediments on fish, mussels or aquatic insects in small streams that experience upstream construction activity. Our notions about the presumed impact of sediment and turbidity are largely drawn from decades-old bioassays of test organisms in standing rather than running waters. Until we obtain more data on biological impacts under real-world stream conditions, we will remain ignorant about what turbidity levels or sediment deposition rates are truly harmful to aquatic life, and will have no basis to set protective standards for construction sites.

The second research priority is a massive sampling effort to characterize sediment concentrations discharged from a large population of construction sites (that are developed with and without erosion and sediment control practices). This characterization data is urgently needed so that we can develop numerical benchmarks to evaluate the performance of ESC practices in the field. Currently, we know so little about sediment concentrations from construction sites that we cannot compute or predict the average sediment concentration during a storm event, and more to the point, cannot estimate how much lower it might have been if effective erosion and sediment control practices were installed.

The third area of research deals with the impact of construction on soil compaction. Prior research has shown that urban soils are significantly and often irreversibly compacted during the construction process (see articles 36 and 37). What we do not yet understand is how soil compaction influences the hydrology and vegetation of urban watersheds, and whether any practices can restore the lost porosity of urban soils.

## **Erosion and Sediment Control Contents**

52.	Muddy Water In, Muddy Water Out? .....	305
53.	Clearing and Grading Regulations Exposed .....	315
54.	Practical Tips for Construction Site Phasing .....	317
55.	Keeping Soil in Its Place .....	323
56.	Strengthening Silt Fences .....	329
57.	The Limits of Settling .....	334
58.	Improving the Trapping Efficiency of Sediment Basins .....	339
59.	Performance of Sediment Controls at Maryland Construction Sites .....	345
60.	Construction Practices: The Good, the Bad and the Ugly .....	348
61.	Delaware Program Improves Construction Site Inspection .....	353
62.	Enforcing Sediment Regulations in North Carolina .....	356

# Muddy Water In, Muddy Water Out?

Construction is considered the most damaging phase of the development cycle for streams and other aquatic resources. Many communities have responded to the many impacts caused by construction sites by enacting erosion and sediment control (ESC) ordinances. Typically, the ordinances require developers to submit a plan that contains measures to reduce soil erosion (erosion prevention) and practices to control sediments that have already eroded (sediment controls). In addition, the plan may restrict or require phasing of the clearing or grading needed to prepare a development site. Once an ESC plan is reviewed and approved by the local or state authority, the ordinance then requires the developer or contractor install and maintain specified measures and practices throughout the construction phase. A construction site may be inspected for compliance, and if found lacking, an inspector may issue a permit violation, stop-work order, fine or other measure to compel action.

### Theory Collides with Reality

How well do these ESC programs work in the real world? Not very well, according to six recent surveys of local and state ESC experts and administrators. Consider these statistics:

- Paterson's (1994) investigation of 128 North Carolina construction sites revealed that 16% of the ESC practices prescribed in the plan were never installed. Of the ESC practices that were actually installed, 16% were not installed correctly and failed to perform. An additional 18% of ESC practices failed because of a lack of maintenance. Combining these three sources of failure together, Paterson found that half of all practices specified in the ESC plans were not implemented properly.
- Mitchell (1993) surveyed state highway erosion control experts, and reported that 30% of respondents noted that at least half of the ESC practices specified in highway ESC plans were never actually installed. While 83% of the respondents indicated that they required a preconstruction meeting with the contractor to discuss ESC plan implementation, only 29% scheduled a pre-wintering meeting. The state highway ESC experts cited five major problems in achieving better highway ESC

control: lack of inspectors, weather, lack of contractor cooperation, lack of state leadership, and contractor ignorance (in rank order).

- North Carolina ESC surveys by Patterson *et al.* (1993) found that contractors actually spent only half the estimated cost to install the ESC controls outlined in their plan. In addition, local governments expended three to six times more effort reviewing plans than actually inspecting them. Despite the fact that a majority of ESC staff spent time in the office, they received very little training nor did they train contractors. Training comprised only one-tenth of one percent of local ESC program budgets.
- According to a survey of 24 ESC local programs in Northeastern Illinois by conducted by Dreher and Mertz-Erwin (1991), less than 45% of ESC plan reviewers had received formal training in ESC techniques. In addition, while a slightly higher number of inspectors were trained in ESC techniques (55%), most training consisted of informal field mentoring by more experienced staff. The researchers also reported a wide range of inspection frequency. For example, 25% of communities only conducted inspections in response to citizen complaints, and 10% inspected construction sites less frequently than one time a month. More positively, half the Illinois programs reported construction site inspections were done weekly or on a more frequent basis.
- Corish's 1995 national survey of 40 local ESC programs documented poor plan implementation. For example, 67% of survey respondents indicated that ESC controls were inadequately maintained. Soils were not adequately stabilized within the prescribed time limit in 44% of ESC programs, and 56% of programs encountered chronic problems with inadequate temporary soil stabilization (grass or mulch cover). Nearly half of the local program respondents noted that sensitive areas adjacent to or within construction sites (such as stream buffers and wetlands) were inadequately protected from sediment or were actually cleared. Trees and forest areas "protected" under the plan were in



fact not protected, according to 57% of respondents. Another 24% reported clearing frequently occurred well beyond the disturbed area specified in the plan. Lastly, 36% of the respondents to Corish's survey observed that steep slopes were improperly cleared, or were inadequately stabilized.

- A national survey of over 80 local ESC programs conducted by Brown and Caraco (1996) discovered that 10% of local ESC programs appear to exist only on paper, as they allocated no staff for either plan review or inspection. Staffing was a major constraint even for the established ESC programs in larger communities that processed in excess of 100 ESC permits each year. Over half of these larger ESC programs had fewer than two plan reviewers and three inspectors to administer their program, and these staff were often asked to perform other duties.

The lack of manpower reflects a chronic funding problem for many local ESC programs, as 75% reported complete dependence on unreliable revenue streams such as application fees or the local operating budget. Brown and Caraco (1996) further noted that a third of all programs surveyed did not require engineering plans, and one-fourth considered themselves a "non-regulatory" program.

Several surveys also noted that ESC practices rated by experts as "most effective" were seldom applied. Conversely, a number of ESC practices rated as "ineffective" still enjoy widespread use (Patterson, 1994; Brown and Caraco, 1996). The four most popular practices cited in a national survey were silt fences, stabilized construction entrances, storm drain inlet protection and temporary vegetative stabilization, all of which rank high in terms of installation and maintenance problems.

The actual sediment removal capability of many ESC practices appears to be fairly limited, with most practices achieving 50 to 85% total suspended solids (TSS) removal rates, according to recent field research. In contrast, sediment removal rates on the order of 95 to 99% are needed to achieve anything resembling a "clear water" discharge.

ESC practices are increasing the cost of development, with several sources estimating they now comprise from three to 6% of total development costs. While this investment would have been unthinkable a few decades ago, it is evident from the foregoing statistics that much of this money is not being well spent—practices are poorly or inappropriately installed, and very little is spent on maintaining them. It is therefore unsurprising that many in the development industry view ESC plans as **"muddy water in, muddy water out, and a lot of money in between."**

Taken together, the information presented here confirms that both the quality and implementation of ESC plans need to be greatly strengthened. In the remainder of this article, we explore practical factors that lead to poor design and implementation of ESC plans based on surveys and expert opinion of ESC professionals. Next, 10 elements that can improve performance are outlined in order to increase plan effectiveness. Finally, some practical recommendations are made to improve the capability of local ESC programs to produce better results in the field, given the reality that resources will always be scarce in most communities.

### **Why Do Erosion and Sediment Control Plans Fail to Perform in the Field?**

Before ESC plans can be improved, it is important to understand the underlying reasons why they fail. In general, poor performance can be explained by two reasons. First, many ESC plans are poorly integrated with other stream protection efforts that occur during construction. Construction is potentially the most destructive stage in the entire development process: trees and topsoil are removed, soils are exposed to erosion, steep slopes are cut, natural topography and drainage are altered, wetlands are filled, and riparian areas are disturbed. Consequently, an ESC plan is about more than preventing sediment from leaving the site. It also sets forth how a stream will be protected during this critical stage of development. The plan should clearly outline where and how other stream protection measures are employed, such as wetland protection, forest conservation, stream buffers, and stormwater treatment practices. It is worth emphasizing that grading and ESC plans are usually the only plans that are routinely read by earthmoving contractors at a construction site. Consequently, any stream protection measure that is dependent or influenced by earthmoving activities - and most are - should be clearly marked on the plan.

Many communities fail to make this important link. As a result, their ESC programs are not integrated into an overall stream protection strategy. For example, only 35% of the local ESC programs considered wetland protection in the ESC plan approval process. An even smaller number (20%) reviewed ESC plans within a watershed or special protection framework (Ohrel, 1996). All too often, ESC plans tend to be developed in isolation from other stream protection plans prepared for the site: someone else designs the stormwater treatment practices, somebody else does the grading plan, while others assemble any wetland protection, forest conservation, stream buffers or other sensitive plans. Because these plans are usually submitted to different agencies and undergo a separate approval process, there is no apparent need to integrate them.



A quick glance through many state and local ESC manuals reveals a second major reason for poor ESC plans: they are based on "cookie cutter" manuals. Most ESC manuals consist of little more than a collection of a few dozen detailed standards and specifications for individual ESC practices. Very little guidance is given on how to combine ESC practices together into an effective plan. In particular, most ESC manuals provide very skimpy coverage about erosion prevention techniques, such as clearing restrictions, protecting the limits of disturbance, and construction phasing. Many of the standard details for ESC practices are outdated, or lack specific guidance on where and when a particular practice is appropriate. For example, Mitchell (1993) reviewed the contents of 49 state highway ESC manuals and found that 50% did not have detailed standards and specifications for 25 of the more common ESC practices. Few practices ever seem to be dropped from ESC manuals, even if monitoring data or maintenance experience prove them to be inadequate. At the same time, design enhancements that can sharply increase the effectiveness of a ESC practice are often recommended but not required. Faced with this choice, cost-conscious designers and contractors will generally only chose to install that which is absolutely required.

With ESC manuals offering relatively little practical guidance, the responsibility for developing a quality plan falls to the design engineer. ESC plans, however, are often among the last elements of a construction plan to be completed, and are usually delegated to junior engineers with little hands-on ESC experience or training. Often, the only resources available to them are the grading plan for the site, a few sample ESC plans and the local ESC manual. Given a tight timetable, a designer rarely has time to visit the site to become familiar with construction site conditions. Thus, it is not surprising that many ESC plans submitted to local agencies for review are of poor quality.

Local plan reviewers, in turn, often lack the time to fix mistakes, or may not have the field experience or specialized training needed to catch them. This leaves it up to the inspector to correct the mistakes at the construction site. At this point, the contractor who based his ESC cost estimate on the original plan, is extremely reluctant to make any changes that will increase costs.

#### Ten Elements of an Effective ESC Plan

How can the implementation of ESC plans be improved? To start, designers and plan reviewers should check their ESC plan to determine if it includes 10 critical elements as portrayed in Figure 1. These 10 elements were drafted in consultation with local and state ESC experts. They present a comprehensive and integrated approach for achieving stream protection

requirements during construction. As a result, only four elements of the 10 actually involve better design and selection of ESC practices. Three ESC elements emphasize non-structural techniques for erosion prevention, while the last three involve management techniques to translate a plan into reality. The 10 elements are as follows:

1. Minimize Needless Clearing and Grading
2. Protect Waterways and Stabilize Drainage Ways
3. Phase Construction to Limit Soil Exposure
4. Immediately Stabilize Exposed Soils
5. Protect Steep Slopes and Cuts
6. Install Perimeter Controls to Filter Sediments
7. Employ Advanced Sediment Settling Controls
8. Certify Contractors on ESC Plan Implementation
9. Adjust ESC Plan at Construction Site
10. Assess ESC Practices After Storms

#### 1. Minimize Clearing and Grading

Clearing and grading should only be performed within the context of the overall stream protection strategy. Some portions of the development site should never be cleared and graded, or clearing in these areas should at least be sharply restricted. These areas include the following:

- Stream buffers
- Forest conservation areas
- Wetlands, springs and seeps
- Highly erodible soils
- Steep slopes
- Environmental features
- Stormwater infiltration areas

A site designer can go even further, however, and analyze the *entire* site to find other open spaces where clearing and/or grading can be avoided. Ideally, only those areas actually needed to build structures and provide access should be cleared. This technique, known as site fingerprinting, can sharply reduce earthwork and ESC control costs, by as much as \$5,000 per acre (Schueler, 1995) and is critical for forest conservation. All "protected" areas should be delineated on construction drawings, and shown as the "limits of disturbance" or LOD. The LOD must be clearly visible in the field, and posted by signage, staking, flagging or most preferably, fences (i.e., silt fence or temporary safety/snow fence). The limits and the purpose of the LOD should be clearly conveyed to site personnel and the construction foreman at a preconstruction meeting. In addition, paving and other subcontractors that



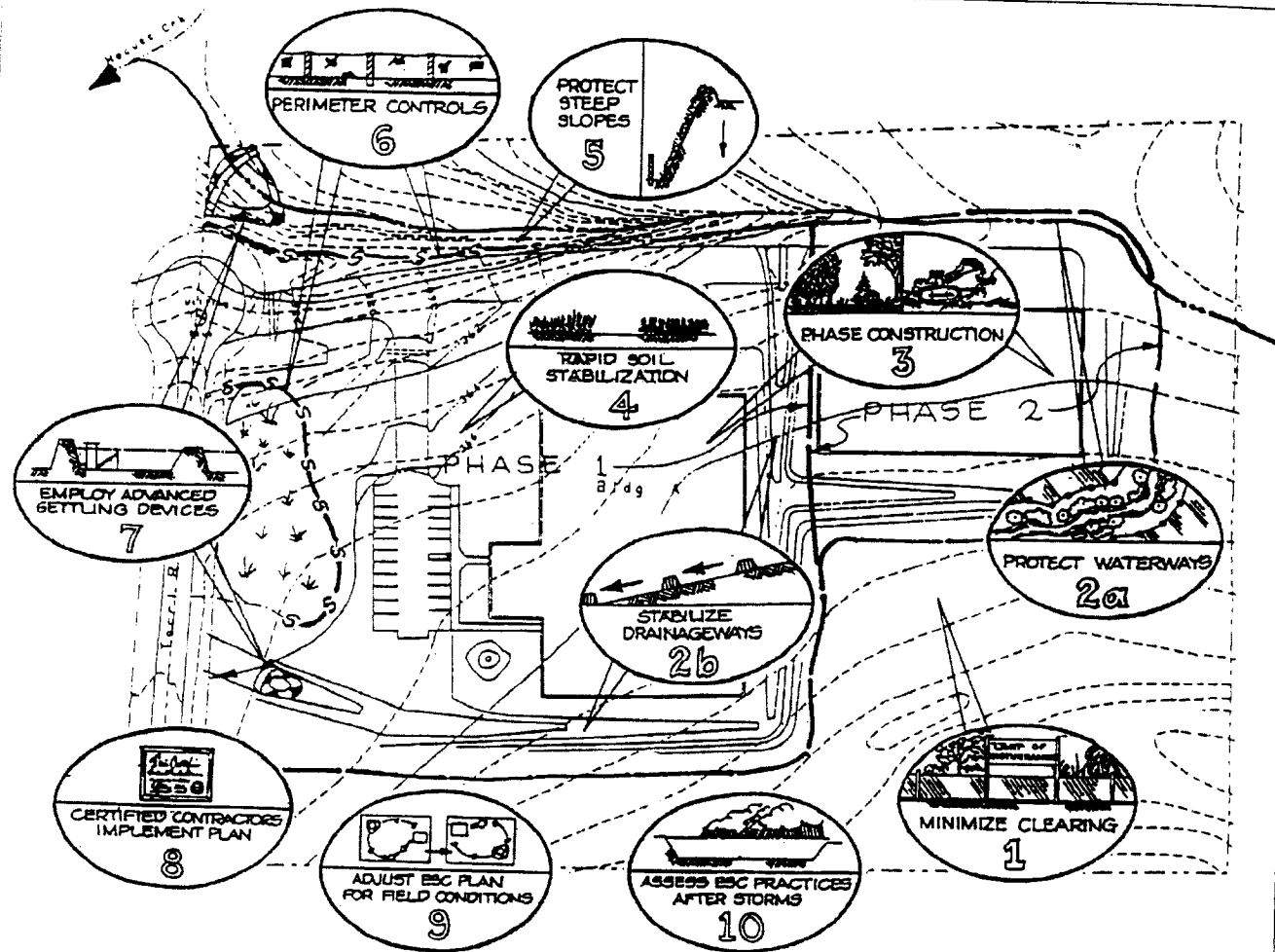

Every site designer and plan reviewer should analyze the construction site to see if it can achieve the ten critical elements of an effective ESC plan, as shown above. (Site plan courtesy of North Carolina Erosion and Sediment Control Manual.)

Figure 1: Ten Critical Elements of an Effective ESC Plan

will be working on the site during a later stage of construction should also be routinely notified about the LOD as they arrive.

#### 2a. Protect Waterways

Streams and waterways are particularly susceptible to sedimentation, and a designer should always check to see if they are present at a site, and whether construction activities will occur near them. If so, no clearing should be permitted adjacent to the waterway. As a secondary form of protection, a line of silt fence or earthen dike should be installed along

the perimeter of the waterway buffer. If work is planned across or within the waterway, special crossings and diversion techniques should be required (WRA, 1986 is an excellent reference in this regard).

#### 2b. Stabilize Drainage Ways

Of equal importance, designers should carefully map the existing and future drainage patterns at the site, known as *drainage ways*. Not only are drainage ways the major route that eroded sediments take to reach streams and waterways, they also are prone to

severe erosion due to the velocity of concentrated runoff that travels through them. Consequently, special ESC practices are applied to the drainage way, depending on their slope and length, and the disturbed areas that drain to them. An ideal drainage way serves as a grassed waterway, which may require sod, erosion control blankets or jute netting to prevent erosion during storms. In addition, checkdams may often be needed along the drainage way, using riprap, earth, dikes or silt fence. The storage provided behind checkdams can trap sediment, and is a useful backup when upstream portions of the drainage way begin to erode into a gully.

### 3. Phase Construction

Mass grading of larger construction sites should be avoided because it maximizes both the time and area that disturbed soils are exposed to rainfall and therefore subject to soil erosion. As an alternative, designers should consider "construction phasing" whereby only a portion of a construction site is disturbed at anyone time to complete the needed building in that phase. Other portions of the construction site are not cleared and graded until the construction of the earlier phase is nearly completed and its exposed soils have been stabilized.

Construction phasing is similar to "just-in-time manufacturing" in that earthmoving occurs only when it is absolutely needed. By breaking the construction site into smaller units, the disturbed area is sharply reduced. This is particularly critical for larger residential and commercial projects that may take one, two or even three years to finish. The potential reduction in sediment load from construction phasing can be very impressive. Claytor computes a 36% reduction in off-site sediment loads in a typical subdivision development scenario (article 54).

Phased construction requires careful planning. For example, each phase must be planned so that earthwork is balanced within it; i.e., the "cut" soil from one area matches the "fill" requirement elsewhere. Other key elements of construction phasing are described in article 54, and include provisions for temporary stockpiling and construction access, and performance criteria for triggering a new phase. In addition, the phases should correspond to existing or future drainage boundaries wherever possible. In general, construction phasing is most appropriate for larger construction sites (25 acres or more).

Lastly, it is important to note that construction phasing should not be confused with the construction sequence, which outlines the specific order of construction that the contractor must follow to complete a single phase. The construction sequence can also

be a critical element of an ESC plan. For example, the construction sequence should clearly state that the first step of construction is a preconstruction meeting, that ESC controls must be installed prior to any clearing or grading, and disturbed areas must be stabilized within a prescribed time limit. In addition, the ESC designer should carefully evaluate the entire construction sequence to determine if additional ESC practices are needed. For example, the locations of drainage ways are often altered as the construction sequence progresses, particularly after storm drains are installed. Consequently, additional ESC practices may be needed to accommodate the greater runoff and new discharge points that occur in later development stages.

### 4. Rapid Soil Stabilization

The objective at every construction site is to establish a grass or mulch cover within a minimum of two weeks after the soils are exposed. Given the germination time for grass, this means that hydroseeding must occur within two to five days after grading. In northern climates, a straw, bark or fiber mulch is needed to stabilize the soil during the winter months when grass does not grow, or grows poorly.

The value of soil stabilization cannot be overemphasized; research in Maryland has shown that it can reduce sediment concentrations by up to six times, compared to exposed soils without stabilization (Schueler and Lugbill, 1990). A review of over 20 field test plot studies of hydroseeding and various mulches on construction site soils indicates an average sediment reduction of about 80 to 90% (see article 55). ESC experts almost universally recommended mulching and seeding in the Brown and Caraco (1996) survey.

An effective ESC plan will clearly define time limits to establish grass and/or mulch cover, outline the rates and species of either cool-season or warm-season grasses to be hydroseeded (or type of mulch), and define the conditions under which the temporary cover must be reinforced (e.g., drought, severe erosion, poor germination, etc.). In particular, a pre-winter meeting should be held at northern construction sites to assess whether the existing soil cover will be adequate throughout these demanding months. A good construction contract should also include a contingency line item for replacing temporary cover in the event that the cover does not take due to drought, poor germination, weather, or other factors. The last objective of the ESC plan is to permanently stabilize disturbed soils with vegetation at the conclusion of each phase of construction.



R0079760

### 5. Protect Steep Slopes

Steep slopes are the most highly erodible surface of a construction site, and require special attention on the part of the designer. Steep slopes are variously defined, depending on local topography and the region of the country, with 15% or 6:1 h:v being fairly common. In addition, grading often creates engineered slopes on cut or fill of as much as 50% (2:1 h:v). Wherever possible, clearing and grading of existing steep slopes should be avoided altogether.

If clearing cannot be avoided, special techniques can be used to prevent upland runoff from flowing down a slope. Otherwise severe gullies quickly form, and the slope can fail. The best method involves diverting upland flow around the slope using an earthen dike or slope drain pipe. An upslope line of silt fence can also be used for this purpose, but only if it is adequately anchored, and contributing flow lengths are 50 feet or less, and a permanent drainage structure is installed to protect the slope.

Silt fencing at the toe of the slope should be applied with great care as high flow velocities and sediment movement downslope will quickly overload or knock the silt fence down. In addition, the performance of silt fence on the toe of slopes is rather low, ranging from 36% to 65% in two Oregon test plot studies (W&H Pacific, 1993). It may be advisable to use a scoop trap or super silt fence under these demanding field conditions. For a description of these techniques, see article 56.

Temporary seeding or mulch, by themselves, may not be effective in preventing erosion on the exposed soils of the slope (Harding, 1990). Additional stabilization methods may be needed such as erosion control blankets and mulch binders. Alternatively, the mulch application rate can be increased. In some cases, steep slopes can be protected in the winter months using plastic sheeting that is suitably anchored (e.g., temporary soil stockpiles).

### 6. Perimeter Controls

Perimeter controls are established at the edge of a construction site to retain or filter concentrated runoff from relatively short distances before it leaves the site. The two most common perimeter control options are silt fences and earth dikes. Other options are available, including using sidewalk gravel as a perimeter filter on very small and flat areas (Portland BES, 1994).

When properly installed, located and maintained, silt fences are moderately effective in filtering sediment, with reported removal rates ranging from 75 to 86% (Goldman *et al.*, 1986). A majority of the ESC experts, however, report chronic problems in

maintaining silt fences (Brown and Caraco, 1996; Paterson, 1994). A field assessment of over 100 silt fences in North Carolina indicated that 42% of all site fences were improperly installed and 66% were inadequately maintained (Paterson, 1994). The correct placement of silt fences is discussed in detail in article 56.

The use of straw bale dikes as a perimeter control is not recommended for most communities, except in special circumstances. Only 27% of ESC experts rated the straw bale as an effective ESC practice, although its use was still allowed in half of the communities surveyed (Brown and Caraco, 1996).

Earth dikes can also be employed as a perimeter control. For small sites, a compacted two foot tall dike is usually suitable, if it is hydroseeded. When larger dikes are employed it should be kept in mind that they will actually divert runoff to another portion of the site, usually to a downstream sediment traps or basin. Therefore, the designer should ensure they have a stabilized outlet, have capacity for the ten year storm event, and that the channel created behind the dike is properly stabilized to prevent erosion. ESC experts typically report fewer maintenance problems with these earth dikes if they are properly engineered (Brown and Caraco, 1996).

### 7. Employ Advanced Settling Devices

Even when the best ESC practices are employed, construction sites will still discharge high concentrations of suspended sediments during large storms. Therefore, the ESC plan should include some kind of trap or basin to capture sediments, and allow time for them to settle out. These settling devices face an imposing performance challenge, as they must operate at a 95 to 99% efficiency to produce a non-turbid discharge. Recent field research, however, indicates that most sediment traps and basins have sediment removal capabilities only on the order of 70 to 90%. They also routinely discharge sediment at a concentration of several hundred mg/l (see article 57).

The limited trapping efficiency of sediment basins in the field appears to be caused by two major factors: the extreme difficulty in settling out fine-grained sediment particles in suspension (i.e., fine silts and clays) and the simplistic design of existing basins which does not produce ideal settling conditions over the range of storm events that can be expected at a construction site. Indeed, most sediment basins are nothing more than a hole in the ground.

To improve their trapping efficiency, sediment basins must be designed in a more sophisticated manner. These design features include greater wet or dry storage volume, perforated risers, better internal



**Table 1: Stages of Construction When Plan Revisions Should be Considered  
(U.S. EPA, 1993)**

Stage	Basis of Plan Changes
Preconstruction meeting	Plan impractical from the contractors' standpoint (e.g., not enough space for materials storage)  Site visit confirms that the plan will not work based on other site characteristics
After clearing/ grading and sediment control installation	"As built" grading or sediment controls are different from the original plan
During construction of the drainage system	Hydrology changes may require new different ESC measures
During house construction	Importing materials and site preparation for home construction will alter the landscape
As needed based on routine inspection visits	Failing measures may need to be modified
After major storms	Major storm events reveal under- or poorly-designed practices
Close of season	Depending on weather or season, stabilization may be different than on the original plan.

geometry, use of baffles, skimmers and other outlet devices, gentler side-slopes and multiple cell construction. A series of recent field and lab research studies has evaluated the effectiveness of these additional sediment basin design features (see article 58). In addition, the ESC plan should contain a detailed inspection and clean out schedule for the basin, along with procedures for converting the basin into a permanent stormwater management facility.

#### 8. Certified Contractors Implement Plan

Plans don't stop sediments from eroding, contractors do. Therefore, the single most important element in ESC plan implementation is a trained and experienced contractor, as they are ultimately responsible for the proper installation and upkeep of ESC practices. In recognition of this fact, many communities now require that key on-site construction staff be certified to implement the ESC plan. For example, both Maryland and Delaware require that at least one person on any construction project be formally certified.

Certification is obtained by completing a mandatory State-sponsored ESC training course. The certified ESC contractor is trained on why ESC is so important in stream protection, how to read ESC plans, and the proper installation and upkeep of ESC practices controls. Typically, the certified contractor is the liaison with the local inspector, and keeps a maintenance and inspection log (see article 61).

Even if no formal certification program exists in a community, there are still several opportunities to train and educate construction personnel on how to implement the ESC plan. These include a mandatory preconstruction meeting, regular inspection visits, a pre-wintering meeting, and the final inspection upon completion of a phase or the entire project. For example, Paterson documented that a preconstruction meeting can increase ESC plan compliance by as much as 15% (see article 60).

An inspector should view every meeting and site inspection as an educational opportunity to provide insight into why ESC practices worked or failed, and what maintenance may be needed in the future. This last item is especially important, as many contractors may not realize that ESC practices require maintenance or repair from time to time. Given tight construction budgets and schedules, it is not surprising that many contractors wait until a local inspector tells them what needs to be fixed. Local governments that make a strong commitment to contractor education report that inspectors and contractors develop a more constructive and responsive partnership at the site.

#### 9. Adjust ESC Plan for Field Conditions

Plans are usually the first casualty in any military engagement, and must be rapidly revised if the battle is to be won. ESC plans are not much different. An effective ESC plan is usually modified as it moves



R0079762

**Table 2: Maintenance Costs as Percentage of Installation Costs  
(U.S. EPA, 1993)**

ESC Practice	Annual Maintenance as % of Installation Cost
Seeding	20%
Mulching	2%
Silt Fence	100%
Sediment Trap	20%
Sediment Basin	25%
Inlet Protection	60%

from the office to the construction site, because of discrepancies between planned and as-built grades, weather conditions, altered drainage, and unforeseen construction requirements. The first opportunities to revise the ESC plan occur during the preconstruction meeting and the initial inspection of the installation of ESC practices. Table 1 highlights some of the more common revisions to the ESC plan that may be needed.

Regular inspections are needed to ensure that ESC plans are properly implemented, with an ideal frequency of once per week or every two weeks. If this inspection frequency is not possible given local staffing, then a community may wish to utilize independent private-sector inspectors to supplement the efforts of local ESC inspector (see article 61)

#### 10. Assess ESC Practices After Storms

After a storm passes, it is very clear whether or not an ESC plan actually "worked" at the construction site. If the storm was unusually large or intense, it is very likely that many ESC practices will need repair, clean out or reinforcement. For example, hydroseeding may wash away, silt fences over-top, earth dikes blow out, sediment basins fill up or gullies form. Therefore, the last element of an effective ESC plan is a rapid response after a storm to assess the damage to ESC practices and quickly correct it.

The dynamic conditions at a construction site make maintenance of ESC practices critical. Some contractors will wait until an inspector threatens them with an enforcement action. The underlying reason for their reluctance is financial: most construction contracts include ESC as a single lump sum installation item in the bid estimate. More often than not, contractors "low ball" the ESC item to be competitive in the overall bid. Thus, they often balk at incurring the "extra" cost to maintain or repair ESC practices because it decreases their profit margin on a job. To avoid these problems, a good construction contract will also include a contingency line item for maintaining and repairing ESC practices. Some estimates of

the expected cost of maintaining selected ESC practices as a percent of the total cost of installing the practice can be found in Table 2.

Other maintenance requirements in the ESC plan include the designation of an on-site (certified) contractor responsible for maintenance, a minimum maintenance schedule, and a periodic self-inspection of the limits of disturbance.

#### How Can Local Communities Foster Better ESC Control?

Over 90% of local ESC programs are administered by municipal agencies or soil conservation districts (Brown and Caraco, 1996). According to the same survey, 60% of local ESC programs were mandated by state laws that provided no funding to support local implementation. Local ESC agencies are chronically strapped for funds, and over 75% rely on local property taxes or application fees as their sole source of revenue. ESC programs must routinely compete with any other unmet spending priorities within a community—and they often lose. Without a dedicated funding source, it is doubtful whether many communities can ever afford the full complement of inspectors and plan reviewers they probably need. Given shoestring budgets faced by so many local ESC programs, how can they realistically improve the performance of ESC plans?

When resources are limited, the only means to become more productive is to dramatically improve how existing ESC program resources are managed. With this in mind, we present 10 modest management tips to get more results with fewer resources.

1. *Leadership.* According to Shaver (1996), the best ESC programs in the country share a common feature: committed local leadership. Key characteristics of effective leaders include a strong belief that ESC is a critical element of local environmental protection, a tireless commitment to educate designers, contractors, and the public about the need for better erosion

7

and sediment control, and a willingness to try new approaches and techniques to continually improve the quality of the ESC program.

2. *Re-deploy existing staff from the office to the field or the training room.* Plan reviewers can be assigned more time at construction sites to get better feedback on the ESC plans they review, and to increase inspection frequency. In addition, training and education should become an integral element of the job description of both inspectors and plan reviewers, with as much as 10% of their time assigned to contractor training or public outreach.

3. *Cross train local development review and inspection staff.* An effective management approach involves cross training in stream protection for all local development review and inspection staff. The cross training provides ESC reviewers and inspectors with an understanding of important stream protection concerns at the site, such as forest conservation, stream buffer, wetland and stormwater management. At the same time, non-ESC staff are able to spot and refer ESC problems when they visit the site, and integrate ESC concerns in their plan review efforts.

4. *Submit erosion prevention elements for early planning review.* Amend the development preview process to require early review of the erosion prevention elements of the ESC plan (minimize clearing and grading, protect waterways, and phase construction). Review of these elements should be closely coordinated with early site plan concepts. In some cases, review of erosion prevention elements can be shifted from the ESC permitting agency to the local planning agency.

5. *Prioritize inspections based on erosion risk.* Use a simple spreadsheet model to schedule inspections more frequently for the construction sites most vulnerable to erosion (Brown and Caraco, 1996). Vulnerability is based on such factors as site area, slope, erodible soils, and proximity to waterways. Even if staff resources are spread too thin to inspect all sites, this approach ensures that the most likely problem sites will get the attention they need.

6. *Require designer to certify initial installation of ESC practices.* The inspection process should be amended so that the ESC plan designer must visit the site to certify that the ESC practices called for in the plan were correctly installed at the construction site (adjusting for any changes that may have been made at the preconstruction meeting). This simple requirement accomplishes two things. First, it is a useful enforcement mechanism to ensure that all ESC practices are actually installed correctly. Second, it is also a great learning opportunity for ESC plan designers,

as they can see how their plan works under the demanding conditions of a construction site.

7. *Invest in contractor certification and private inspector programs.* The ESC workforce can be quickly multiplied when a community invests in a contractor certification or private inspector program. The Delaware model is described in detail in Homer *et al.* (1994), and in article 61.

8. *Use public-sector construction projects to demonstrate effective ESC controls.* Local governments are a source of a lot of construction projects—new schools, roads, and other infrastructure. Needless to say, ESC practices on public-sector projects should always be first class, so they can be used as demonstration sites for contractor training and tangible evidence of local commitment to ESC. In addition, public sector construction documents should include contingency items and other contractual provisions that allow contractors to recover the full cost of maintaining ESC practices.

9. *Enlist the talents of developers and engineering consultants in the ESC programs.* Both groups provide useful input on how ESC practices can be applied more cost-effectively or how the plan review process can be streamlined. Many communities have found that this advisory group is very helpful in developing a constructive partnership for improving ESC plans.

10. *"Reinvent" the local ESC manual.* A productive task to assign to the advisory group is to revisit the current ESC manual and local training materials. This will improve the quality of ESC plans and the overall performance of ESC measures installed at construction sites.

If these measures are taken, the murky mixture that usually leaves construction sites will be considerably less sediment laden. ESC plans will never produce 100% sediment-free runoff, but the dollars communities spend can be put to best use when erosion prevention and sediment control practices are applied with greater care, vigor and ingenuity.

— WEB and DSC



R0079764

## References

- Brown, W., and D. Caraco. 1996. *Task 2 Technical Memorandum: Innovative and Effective Erosion and Sediment Control Practices for Small Sites*. Center for Watershed Protection. Silver Spring, MD. 37 pp.
- Corish, K.A., 1995. *Clearing and Grading Strategies for Urban Watersheds, Final Review Draft*. Metropolitan Washington Council of Governments, Washington, D.C. 66 pp.
- Dreher, D.W., and L. Mertz-Erwin. 1991. *Effectiveness of Urban Soil Erosion and Sediment Control Programs in Northeastern Illinois*. Northeastern Illinois Planning Commission. Chicago, IL. 23 pp.
- Goldman, S., et al. 1986. *Erosion and Sediment Control Handbook* McGraw-Hill. New York. 443 pp.
- Harding, M.V. 1990. "Erosion Control Effectiveness: Comparative Studies of Alternative Mulching Techniques." In: *Environmental Restoration: Science and Strategies for Restoring the Earth*. Island Press. Covello, CA 149-156.
- Horner, R., J. Skupien, E. Livingston and E. Shaver. 1994. *Fundamentals of Urban Runoff Management*. Appendices A and B. Terrene Institute. Alexandria, VA. 302 pp.
- Mitchell, G. 1993. *Assessment of Erosion/ Sediment Control in Highway Construction Project*. Ohio University Center for Geotechnical and Environmental Research. Final Report to Ohio Department of Transportation. FWHA/OH-93/011. Columbus, OH. 200 pp.
- Ohrel, R.L. 1996. *Technical Memorandum: Survey of Local Erosion and Sediment Control Programs*. Center for Watershed Protection. Silver Spring, MD. 25 pp.
- Paterson, R. G. et al. 1993. "Costs and Benefits of Erosion and Sediment Control: the North Carolina Experience." *Environmental Management* 17(2):167-178.
- Paterson, R.G. 1994. "Construction Practices: The Good, the Bad and the Ugly." *Watershed Protection Techniques* 1(3): 95-99.
- Portland Bureau of Environmental Services (BES). 1994. *Erosion Prevention and Sediment Control Plans - Technical Guidance Handbook*. Portland, OR. 40 pp.
- Schueler, T., and J. Lugbill. 1995. *Site Planning for Urban Stream Protection*. Center for Watershed Protection. Metropolitan Council of Governments. Silver Spring, MD. 222 pp.
- Schueler, T., and J. Lugbill. 1990. *Performance of Current Sediment Control Measures at Maryland Construction Sites*. Metropolitan Washington Council of Governments. Washington, D.C. 90 pp.
- Shaver, E. Personal Communication. September 26, 1996. *Delaware Department of Natural Resources and Environmental Control*. Dover, DE.
- U.S. EPA. 1993. *Guidance for Specifying Management Measures for Nonpoint Pollution in Coastal Waters*. EPA 840-B-92-002. Washington, D.C. 740 pp.
- Water Resources Administration (WRA). 1986. *Maryland's Guidelines to Waterway Construction*. Department of Natural Resources. State of Maryland, Annapolis, MD. 56 pp.
- W&H Pacific and CH2M-Hill. 1993. *Demonstration Project Using Yard Debris Compost for Erosion Control*. Portland Metropolitan Service District. Portland, OR. 90 pp.

R0079765



## Article 53

Technical Note #40 from *Watershed Protection Techniques*, 1(3): 141-142

# Clearing and Grading Regulations Exposed

Perhaps the single most destructive stage in the development process involves the clearing of vegetative cover and the subsequent grading of the site to achieve a more buildable landscape. The potential impacts to a stream and its watershed in this stage are numerous and profound. Trees and topsoil are removed, and soils are exposed to erosion. Heavy equipment compacts underlying soils, reducing their capability to infiltrate rainfall. Steep slopes are cut, and the natural topography and drainage of the site is altered. The existence of buffers and environmentally sensitive areas are at risk from clearing or erosion.

For many years, local governments have recognized the environmental consequences of poor clearing and grading practices and have adopted a series of regulations during this phase of development. These diverse regulations include restrictions on clearing steep slopes, requirements to install sediment controls, and requirements to revegetate exposed soils or protect existing trees.

Corish (1994) analyzed the quality and effectiveness of these regulations in a detailed survey of 43 local government programs across the country. In most communities, these regulations had been on the books for 10 years or more (68%) and had seldom been revised (only 33% of all programs had been revisited, usually to strengthen tree protection requirements). Her study indicated that many local clearing and grading programs could stand significant improvement. The results are summarized in Table 1. Key findings include the following:

### *Inadequate Revegetation of Cleared Sites*

While nearly all programs required that exposed soils must be revegetated after final grading (88%), the survey results indicate that this may not be a rapid or successful operation. For example, one-third of all programs did not impose any time limit for the permanent revegetation of the site, thereby increasing the chances for soil erosion to occur. Communities that did impose a time limit were rather generous, as over two-thirds allowed more than three weeks for revegetation. Even so, 44% of the programs indicated that soils were often still exposed after their prescribed time-limit expired. Problems were also routinely encountered in establishing good cover after revegetation occurred—56% of

local programs surveyed indicated that revegetation efforts were frequently unsuccessful due to poor planting or seeding techniques.

### *Few Limits on Excessive Clearing*

Few communities have sought to actually prevent excessive clearing and grading at the site. Instead, they primarily focus on the control of erosion *after* it occurs (e.g., through vegetative stabilization, sediment traps and other controls). For example, only 17% of all programs specified that a portion of the site may not be cleared or graded. Even less (15%) indicated that their ordinance required a developer to phase or sequence construction so as to reduce the length of time that the entire area is exposed to erosion. Only 36% of programs

Table 1: Clearing and Grading Report Card, N = 43  
(Corish, 1995)

Program element	Percentage reporting
Preserved trees are not adequately protected	57
Sensitive areas are not adequately protected	49
Too much land is needlessly cleared	24
A minimum portion of site must remain undisturbed	17
E&S controls are not adequately maintained	67
Required revegetation is unsuccessful	56
No time limit for revegetation is imposed	33
A time-limit greater than 20 days is imposed	33
Land remains unvegetated after time limit expires	44
Clearing or grading in floodplains, erodible soils, stream buffers or riparian areas is prohibited in their ordinance	40 or less
Cleaning of steep slopes is prohibited by law	36
Cleared slopes are not adequately protected	44
Slopes are cut more than authorized on plan	26
Requires practices to prevent soil compaction	28
Soil compaction is a severe problem at the site	28
Few problems encountered during construction	18
As-built topo survey is required for compliance	28
Preconstruction inspections used to define limits of disturbance	40

prohibited clearing on steep slopes that generate the greatest erosion rates and sediment yields. Very few communities (less than 40%) specifically restricted clearing in floodplains, riparian areas, stream buffers and erodible soils. A clear implication is that most local clearing and grading regulations could be vastly improved if they devoted as much attention to reducing clearing as they do to controlling erosion.

#### *Rampant Problems During Construction*

The survey indicated that 82% of communities encountered major problems in the field during construction. The most common problems were poor installation and maintenance of ESC practices (67%), inadequate protection of trees or vegetative cover (57%), poor delineation of areas requiring revegetation or stabilization (51%), inadequate protection of buffers and environmentally sensitive areas (49%) and inadequate protection of cleared slopes (44%).

While 75% of all programs devote resources to periodically inspect sites after construction begins, a much smaller percentage (40%) conduct a preconstruction walkthrough to delineate limits of disturbance. Again, while most programs will immediately stop work if a developer lacks an approved clearing and grading program, only 60% require that the developer post a performance bond to ensure that the clearing and grading is done according to plan. Even fewer programs (28%) require that an as-graded survey be submitted to objectively document satisfactory performance.

The survey clearly underscores the need to revisit clearing and grading ordinances in many communities to minimize excessive clearing; increase the speed and success of revegetation; and continually improve the implementation of erosion and sediment control practices. The checklist referenced in Table 2 is a useful starting point for this important exercise. — TRS

#### **Reference**

Corish, Kathleen. 1995. *Clearing and Grading Guidance: A Guide to Improving Clearing and Grading Regulations Through Non-Structural Best Management Practices*. Metropolitan Washington Council of Governments. Washington, D.C. 48 pp.

**Table 2: A Checklist for Evaluating the Effectiveness of Local Clearing and Grading Ordinances**

- Does the ordinance require revegetation within 15 days during growing season? — and mulch/straw stabilization in non-growing season?
- Does it contain any criteria to measure the success of revegetation efforts?
- Does it clearly prohibit clearing or grading within the 100 year floodplain, wetlands, stream buffers, and erodible soils?
- Does it require that the areas above are protected by fencing or signs during construction?
- Does it require that a minimum area of the site remain uncleared?
- Are there any incentives provided to developers to minimize the extent of forest clearing? (e.g., footprinting)
- Are special erosion control practices required when slopes exceed 10 to 15%?
- Is clearing prohibited on slopes >25%?
- Are roads and other structures located along natural contours?
- Does the ordinance require phased construction on larger development sites to reduce the duration of soil exposure?
- Does it contain any mechanism to minimize soil compaction during construction, especially near trees?
- Does it contain provisions to conserve forests and protect individual trees during the construction process?
- Are there any measures to preserve existing topsoil?
- Is a preconstruction walk through required to delineate the limits of disturbance?
- Are performance bonds required to assure proper compliance and successful revegetation?

## Article 54

Technical Note #88 from *Watershed Protection Techniques*, 2(3): 413-417

# Practical Tips for Construction Site Phasing

What is construction site phasing and why is it important? These questions are frequently asked by both developers and regulators seeking to implement erosion and sediment controls at construction sites. Construction phasing is different than construction sequencing. As most contractors and developers will tell you, construction sequencing is the standard practice of completing one portion or aspect of a project at a time, with site grading typically completed in a single step. In many circumstances, the time difference between clearing and actual building construction can take years. Table 1 illustrates a typical construction sequence for a single family residential subdivision.

Construction site *phasing* minimizes soil erosion through a somewhat more complex construction process. Only one portion of a site is disturbed at any one time to construct the infrastructure necessary to complete that phase. Subsequent phases are not started until earlier phases are substantially completed and exposed soils are mostly stabilized. This "just-in-time" construction practice can dramatically reduce disturbed soil exposure times and resulting erosion problems.

Despite the value of construction phasing, very few projects are successfully phased. Because many *sediment control* practices are at best 90% efficient in removing suspended solids, *erosion prevention* techniques that limit the erosion of sediments in the first place can have dramatic results in reducing sediment loss from construction sites (Corish, 1995). Uncontrolled urban construction sites can lose between 20 and 200 tons/acre of sediment per year (Dreher and Mertz-Erwin, 1991). Contrast this with an undisturbed meadow or forest, which loses less than one ton/acre of sediment per year. Clearly, a great reduction in sediment export is possible when clearing is reduced. As can be seen in Table 2, a carefully phased project can reduce sediment loss by more than 40% over a typical mass-graded site.

Construction phasing is only one of several *erosion prevention* techniques that can be used to reduce soil loss. Instead of relying on trapping already suspended solids, the phasing techniques rely on erosion prevention. Other erosion prevention strategies involve minimizing disturbed areas through various techniques such as fitting the de-

Table 1: Typical Construction Sequence of a Single Phase Residential Subdivision

1. Hold preconstruction meeting
2. Clear/grub areas necessary to construct ESC practices
3. Construct ESC practices
4. Construct stormwater management measures to be used for temporary ESC
5. Clear/grub remaining site areas
6. Grade site to rough grades
7. Construct utilities (water, sewer, storm drain, etc.)
8. Construct roads (paving, curb and gutter, sidewalks)
9. Construct housing (provide on-lot ESC practices)
10. Stabilize disturbed areas
11. Convert stormwater management measures to permanent functions
12. Remove ESC measures
13. Stabilize remaining disturbed areas

R0079768

**Table 2: Sample 100-Acre Single Family Residential Development Project  
Potential Sediment Loss for a Mass-Graded Project Versus a Phased Project**

**Development Scenario - Conventional Project**

100-acre site, mass-graded over a 6 month period.

*Assumptions:*

Good sediment control practices, successful vegetative stabilization of disturbed areas within 30 days of completion of grading. Approximately 3/4 of site exposed during 6 month grading operation, with 1 month stabilization period. 20 tons/year lost from construction site with sediment trapping effectiveness of 60% for sediment control devices

*Sediment loss:*

Exposure: 3/4 of 100 acres exposed over 7 months

Sediment loss:  $(.75)(100 \text{ ac})(20 \text{ tons/yr})(7/12 \text{ yr})(0.4) = 350 \text{ tons}$

**Development Scenario - Phased Project**

100-acre site, graded in 4 separate phases over a 6 month period, each phased exposed for one and a-half months.

*Assumptions:*

Good sediment control practices, successful vegetative stabilization of disturbed areas within 30 days of completion of grading. Each phase completely disturbed during 1½ month grading operation, with a one-month stabilization period. 20 tons/year lost from construction site with sediment trapping effectiveness of 60% for sediment control devices. One ton/year lost from undisturbed site, two tons/year lost from stabilized portions of site.

**Exposure:**

- 4 phases of 25 ac exposed over 2.5 month period
- 1 phase of 25 ac undisturbed for 4.5 months
- 1 phase of 25 ac undisturbed for 3 months
- 1 phase of 25 ac undisturbed for 1.5 months
- 1 phase of 25 ac completed for 4.5 months
- 1 phase of 25 ac completed for 3 months
- 1 phase of 25 ac completed for 1.5 months

**Sediment loss:**

- $(4)(25 \text{ ac})(2.5/12 \text{ yr})(20 \text{ tons/yr})(0.4) = 167 \text{ tons}$
- $(25 \text{ ac})(4.5/12 \text{ yr})(1 \text{ ton/yr}) = 9.4 \text{ tons}$
- $(25 \text{ ac})(3/12 \text{ yr})(1 \text{ ton/yr}) = 6.3 \text{ tons}$
- $(25 \text{ ac})(1.5/12 \text{ yr})(1 \text{ ton/yr}) = 3.1 \text{ tons}$
- $(25 \text{ ac})(4.5/12 \text{ yr})(2 \text{ tons/yr}) = 18.8 \text{ tons}$
- $(25 \text{ ac})(3/12 \text{ yr})(2 \text{ tons/yr}) = 12.6 \text{ tons}$
- $(25 \text{ ac})(1.5/12 \text{ yr})(2 \text{ tons/yr}) = 6.2 \text{ tons}$

**Total Sediment Loss:**

**223 tons**

**Result: Phasing results in a 36% reduction in sediment export compared to regular mass grading**

velopment to the topographic "lay of the land;" minimizing the development footprint by clearing only the land required for buildings, roads, and utilities; providing buffers from natural drainage systems and water bodies; and conserving or retaining existing forest cover. Immediate stabilization of disturbed areas by use of tackifiers, re-vegetative practices, mulching or stabilization blankets can also dramatically reduce soil loss caused by erosion.

Recent research consistently shows that erosion prevention techniques are among the most effective in reducing suspended solids concentrations leaving construction sites. Many erosion prevention methods can reduce sediment loads by as much as 90%, whereas sediment trapping devices often have

lower removal efficiencies, particularly for fine-grained soils and clays (Brown and Caraco, 1996). The conclusion is obvious. Erosion prevention works. When it can be implemented in a cost effective manner, it is certainly worth pursuing. Clearly, construction phasing falls in this category.

**Foundations of Successfully Phased Projects**

Why is it so hard to get successfully phased projects implemented? The answer involves several practical problems in construction logistics, any one of which can doom a phased project to failure. First, phasing must be carefully planned at the early design stages of the development process. As most land planners will tell you, good planning is hard. It is

Figure 1: Typical Phasing Plan and Important Elements for A Single Family Residential Subdivision (Arendt, 1996)

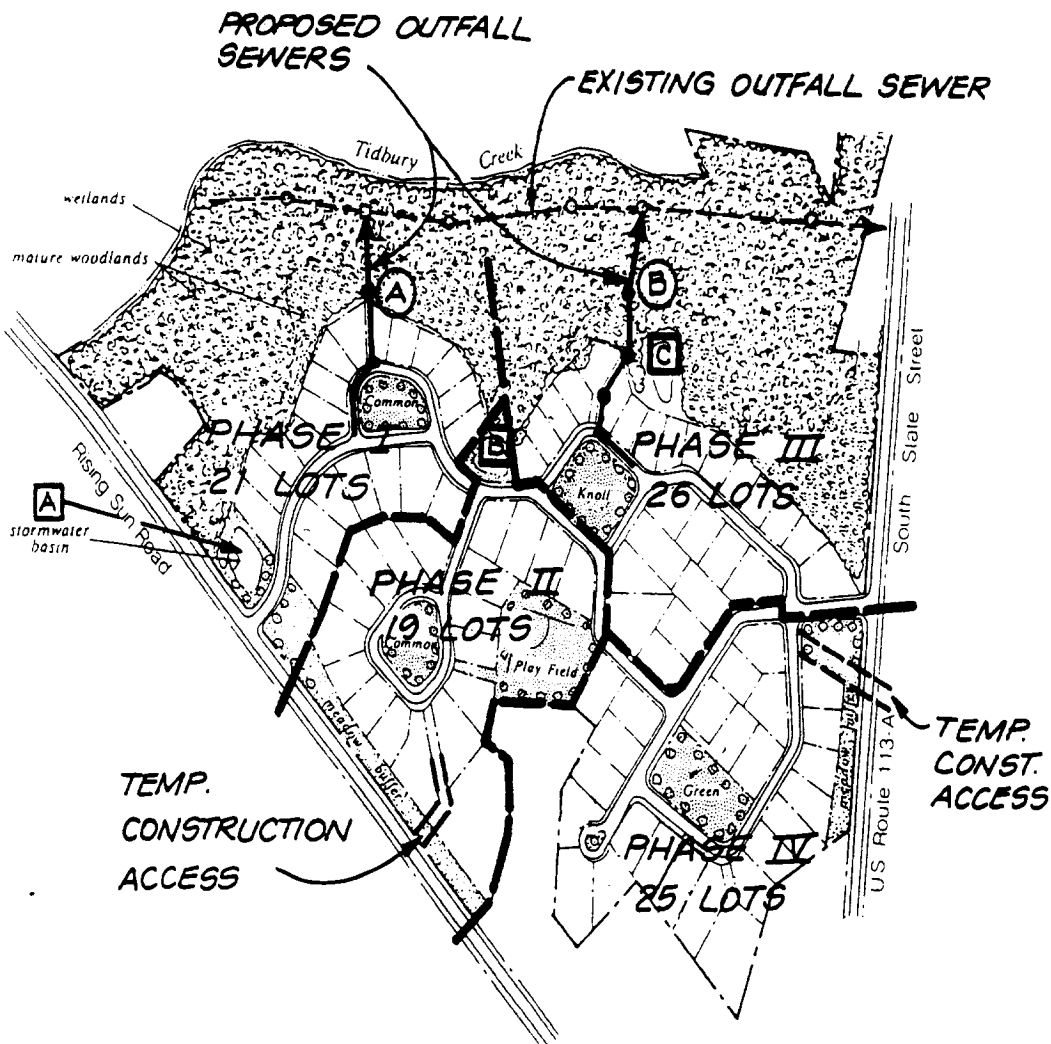

Construction phasing is a major ESC strategy for this large residential subdivision project. The site is subdivided into four distinct phases; clearing cannot proceed on a phase until the prior phase has been largely stabilized.

Notes:

1. Earthwork balances between each phase.
2. Phase I & II are sewered through outfall (A).
3. Water loops through project in phases starting at Rising Sun Road to South State Street
4. Stormwater management provided as follows:  
 Phase I - (A)  
 Phase II - (B)  
 Phase III & IV - (C)
5. Temporary construction access provided as shown.
6. Each phase consists of at least 19 lots. At least 50% of houses must be completed within a phase before construction on next phase can proceed.
7. Phase IV is uphill from Phase III. Utilize stormwater facility (C) as a temporary sediment basin until Phase IV is complete. Flush stormwater system through Phases III and IV.

7

R0079770

difficult to think about construction phasing during the project layout stage. Why is this important to do early on? Because in order to construct a phased project that reduces soil loss, portions of the site that will be developed in the future must remain undisturbed. To do this, cut and fill quantities must balance by phase so that other site areas are not raided to either borrow or spoil dirt.

Other elements to consider during the planning stage include evaluating how stormwater will be conveyed and managed in each phase, whether water and sewer connections/extensions can be accommodated in a phased project and what happens to already completed downhill phases. It is also preferable to separate construction access from resident

access to avoid conflicts between people living in earlier phases of the project and construction equipment working on later phases.

Obviously, the overall size of the project is a major factor in determining whether phasing can be successful. The results of a recent survey of more than 80 local ESC programs provide some insight into this issue. While approximately 45% of respondents used phasing, many reported that phasing was only appropriate for larger sites (i.e., greater than 25 acres). Only a few programs utilize phasing on projects smaller than five acres (Brown and Caraco, 1996). Table 3 provides a summary of some of the key requirements for planning successful phased projects.

**Table 3: Some Keys to Planning Successfully Phased Projects**

- Phasing plan is developed early in the project planning and design stage
- Natural features such as streams or drainage boundaries are considered in multiple phases
- Earth removal is balanced within each phase so cut soil from one area matches fill requirements elsewhere
- Size of project is conducive to phasing
- Phasing is not cost prohibitive

**Table 4: Eleven Phasing Principles for Design Engineers and Plan Reviewers**

1. Segregate temporary construction access in each phase from access for permanent residents.
2. Determine if site meets minimum "threshold" size (approximately 25 acres for ¼ acre single family residential projects).
3. Balance earthwork within each phase.
4. Carefully locate temporary stockpiles and staging areas to prevent additional soil disturbance.
5. Establish "trigger" for completion of each phase in order to start the next phase (e.g., # of houses completed in previous phase, or % of previous phase stabilized).
6. Accommodate water/sewer and other utility construction within each phase.
7. Incorporate road segments, temporary turn-arounds, and emergency access within each phase.
8. Address both temporary and permanent stormwater management in each phase.
9. Clearly identify sequence of construction of each phase and entire project on plan.
10. Identify key ESC elements to inspect in each phase (e.g., after installation of perimeter sediment controls).
11. Ensure that later upstream phases address potential impacts to already completed downstream phases of the construction site.

Figure 1 shows how phasing elements are considered in a construction project. One of the more important considerations for phased projects is the influence of market forces. Land developers often locate model homes in prominent locations that may or may not fit with the phasing plan. Furthermore, developers and homebuilders also want the flexibility to provide buyers with a variety of housing options and therefore are often hesitant to restrict construction to just one section. Another uncertainty is the size of individual sections and the construction rate of individual houses. The phasing plan must address these market forces and designate how many houses must be completed within a given section before allowing construction to begin on the next phase.

How much does phasing really cost? While watershed managers agree that phasing is a desirable erosion prevention technique, most also concede that phasing probably costs developers more money. The cost to a municipal agency of implementing an aggressive phasing program may also be higher. Permit review of phasing plans and construction site inspection costs will certainly be higher.

Obviously, limiting mass grading as an allowable construction technique will tend to increase earthwork costs—already one of the more expensive components of site development. Economies of scale may be undermined by project phasing. Costs may rise due to multiple visits with heavy earth moving equipment, increased storage requirements and equipment handling. How much more expense does phasing add to a typical construction project? The answer is that we don't really know because very little economic research has been done to answer this question.

Cahill and Homer (1992), however, contend that non-structural, minimum disturbance techniques reduce the operation and maintenance costs substantially over structural practices. It does stand to reason that a carefully coordinated phased project can actually save developers money in reduced ESC practice maintenance costs and perhaps in reduced interest carrying costs. Because the entire project is not constructed at one time, only a fraction of the infrastructure installation and maintenance costs are incurred up-front. Developers make smaller construction loan payments for smaller components of construction, which can be paid off as home sales proceed. Furthermore, if the project takes several years to complete, then phasing may result in less re-grading due to erosion caused by slope failures.

Phasing can also be very hard to enforce. Incomplete or confusing phasing plans make permit compliance difficult. Inspectors can face difficulties caused by the several stages of development occurring at one

time. For example, if mass-grading is occurring in one phase, simultaneously with drainage and road construction in another phase, and house construction in yet a third phase, it can be next to impossible for inspectors to enforce. One way to deal with this problem is to clearly specify in the phasing plan the allowable construction elements that can occur simultaneously. Table 4 presents a list of eleven "phasing principles" for plan reviewers and designers to consider when designing or reviewing phased projects.

How can more widespread use of phasing in construction site development be encouraged? Some communities are trying an enforcement approach, while others are looking for more voluntary measures. Prince George's County, Maryland, requires a phasing plan to be submitted with the erosion and sediment control plan. The phasing plan becomes part of the enforceable erosion and sediment control plan, and can be used to inspect compliance in the field. Some municipalities utilize clearing ordinances to limit total disturbed areas (Corish, 1995). Other municipalities are looking at incentives such as *faster review times*, or *more flexible permit conditions* to encourage developers to consider phased projects. One incentive which has not yet enjoyed widespread use, but may have a great deal of promise, is the use of economic incentives such as *reduced or waived permit fees or bonds* for projects with phased sections. Many jurisdictions already refund bonds for completed sections so this incentive may be a logical step.

What lessons can be learned about phasing? Construction site phasing provides a viable, practical technique to reduce sediment loads leaving construction sites. There are practical considerations that must be addressed to ensure that phasing works. It is difficult enough to get compliance on many aspects of a construction site, so good planning at the design stage coupled with an enforceable phasing plan is essential.

Little research has been done to assess the costs of phasing versus conventional construction costs, but obviously the larger the project, the easier it will be to implement successful phasing. Communities must strive to use a combination of enforcement measures and incentives to encourage wider use of this practice. Finally, we cannot forget to consider how market forces govern home sales. While the best phasing plans have strict provisions describing when certain elements of a project can begin and what must be accomplished first, they don't necessarily reflect the market pressures influencing developers. To accommodate market realities it may



be wise to integrate a developer's sales strategy with the requirements of a phasing plan.

—RAC

#### References

- Arendt, Randall. 1996. Natural Lands Trust. Media, PA.
- Brown, W., and Caraco, D. 1996. *Task 2 Technical Memorandum: Innovative and Effective Erosion and Sediment Control Practices for Small Sites*. Center for Watershed Protection. Silver Spring, MD. 37 pp.
- Cahill, T.H., and Horner, W.R. 1992. *Structural and Nonstructural Best Management Practices for the Management of Nonpoint Source Pollution in Coastal Waters: A Cost-Effectiveness Comparison*. Cahill Associates. Trenton, NJ. 22 pp.
- Corish, K.A., 1995. *Clearing and Grading Strategies for Urban Watersheds, Final Review Draft*. Metropolitan Washington Council of Governments, Washington, D.C. 66 pp.
- Dreher, D.W., and L. Mertz-Erwin. 1991. *Effectiveness of Urban Soil Erosion and Sediment Control Programs in Northeastern Illinois*. Northeastern Illinois Planning Commission. Chicago, IL. 23 pp.
- Ohrel, R.L. 1996. *Technical Memorandum: Survey of Local Erosion and Sediment Control Programs*. Center for Watershed Protection. Silver Spring, MD. 25 pp.



## Article 55

Technical Note #81 from *Watershed Protection Techniques*, 2(3): 418-423

# Keeping Soil in Its Place

Perhaps the most critical stage at a construction site is when soils are exposed both during and after clearing and grading. Erosion of these exposed soils can be sharply reduced by stabilizing the soil surface with erosion controls. For many contractors, erosion control is just shorthand for hydroseeding. However, a wide range of erosion control options are available, including mulching, blankets, plastic sheeting, and sodding, among others.

In this article, the performance, costs and constraints of these often-confusing erosion control options are compared. Guidance is provided on when each method should be used or avoided. In addition, the article outlines options for effective erosion control under challenging site conditions, such as the non-growing season, steep slopes, drought, concentrated flows, stockpiles and poor soils.

### Effectiveness of Erosion Controls

Four recent studies evaluated the effectiveness of 15 erosion controls (Table 1). With a few exceptions, suspended solids load reductions were on the order of 80 to 90%. This suggests that erosion controls are extremely effective, when compared to the 60 to 70% sediment removal typically reported for most sediment controls.

### Benefits of Erosion Controls

Erosion controls have benefits beyond controlling erosion. First, they can improve the performance of sediment controls. Controlling erosion reduces the volume of sediment going to a sediment control device. Consequently, less treatment volume is reduced by sedimentation and "clean out" frequencies are lower. In addition, many erosion controls can lower surface runoff velocities and volumes, preventing damage of perimeter controls.

Table 1: Sediment Removal Efficiency of Surficial Erosion Controls

Erosion Prevention Techniques	Sediment Reduction (%)
Straw (1.25 tons/ ac) <sup>1</sup>	93.2 <sup>a</sup>
Straw (2 tons/ ac) <sup>2</sup>	89.3 <sup>b</sup>
Fiber mulches (about 1.0 tons/ac) <sup>3</sup>	65.0 - 97.1 <sup>b</sup>
Fiber mulch (at least 1.0 tons/ac) <sup>4</sup> 3% tackifier	91.8 <sup>c</sup>
Fiber mulch (1.25 tons/ ac) <sup>1</sup> fertilized, seeded	89.1 <sup>a</sup>
Fiber mulch (1.25 tons/ ac) <sup>1</sup> fertilized, seeded 90 gal/ac tackifier	85.9 - 99.1 <sup>a</sup>
70% wheat straw/30% coconut fiber blanket <sup>2</sup>	98.7 <sup>b</sup>
Straw blankets <sup>3</sup>	89.2-98.6 <sup>b</sup>
Straw blanket <sup>1</sup>	92.8 <sup>a</sup>
Curled wood fiber blanket <sup>1</sup>	28.8 <sup>a</sup>
Curled wood fiber blanket <sup>3</sup>	93.6 <sup>b</sup>
Curled wood fiber blanket <sup>2</sup>	93.5 <sup>b</sup>
Jute mat <sup>1</sup>	60.6 <sup>a</sup>
Synthetic fiber blanket <sup>1</sup>	71.2 <sup>a</sup>
Nylon monofilament blanket <sup>2</sup>	53.0 <sup>b</sup>
Mixed yard debris (410 cy/ac) <sup>4</sup>	95.0 <sup>c</sup>
Leaf Compost (410 cy/ac) <sup>4</sup>	85.9 <sup>c</sup>

<sup>a</sup> TSS load reduction <sup>b</sup> Soil load reduction <sup>c</sup> TSS event concentration reduction

<sup>1</sup> 24% slope gravelly sandy loam for 13 storms over two Washington winters. (Horner *et al.*, 1990)

<sup>2</sup> 9% slope silt loam soil. Subjected to 5.8", one hour simulated storm. (Harding, 1990)

<sup>3</sup> 30% slope clay loam soil; subjected to 3.1", 1/2 hour simulated storm. (Wall, 1991)

<sup>4</sup> 34% slope clay cap and top-soil mixed slope. Five March Oregon storms. (W+H Pacific and CH2M-Hill, 1993)

7

R0079774

Table 2: Comparison of Erosion Control Methods

Materials Type	Cost (\$/sy)	Uses	Limitations/ Disadvantages
Seeding	0.10 <sup>a</sup>	As a permanent or temporary erosion control Established grass is the most effective erosion control.	Climate (dry or cold weather) Infertile soils (needs fertilizer, lime, etc.) Needs some other surficial cover on most slopes
Mulch	0.20-0.35 <sup>a</sup>	As a protection for seeds Alone as a temporary erosion control	Slopes steeper than 20% for straw Slopes steeper than 40% for bark/compost Can interfere with grading operations Straw or Hay mulch needs to be secured to the soil surface
Blankets	1.00-2.00 <sup>b</sup>	Useful on steeper slopes than mulches Protects seeds and prevents erosion	Installation is more complicated and time-consuming than for mulches
Plastic Sheeting	0.05-0.15 <sup>b</sup>	Temporary control for very small areas	Does not allow infiltration of runoff Edges must be weighed down or runoff will flow under the sheeting Unsuitable for areas greater than 2,000 sq.ft.
Sodding	1.80 <sup>a</sup>	Provide immediate vegetative cover Can be used in low-flow channels	Drought or poor soils can impede growth Most expensive

<sup>a</sup> Costs adapted from U.S. EPA 1993.    <sup>b</sup> Costs based on phone survey information.

Erosion control can actually preserve topsoil, and reduces the need for re-grading at the site because of rill and gully formation. Furthermore, erosion control reduces landscaping costs by limiting the need to import topsoil.

The comparative costs and uses of five common erosion control methods are outlined in Table 2 and are described below.

*Seeding*

Establishing grass cover is the perhaps the most effective erosion control method. Lee and Skogergboe (1985) found that suspended solids load decreased by 99% when biomass increased from zero to 2,464 lb/ac. Although some surficial erosion controls, such as mulch and blankets, can achieve similar removal rates, grass can provide permanent erosion control. Establishing grass cover can be challenging, however, and requirements can vary considerably from site to site. Choosing the right species and providing an adequate growing environment are critical to vegetative establishment (Table 3). Specific information varies both regionally and seasonally.

The three most common seeding methods are *broadcast seeding*, *hydroseeding* and *drill seeding*. In broadcast seeding, seeds are scattered on the soil surface. It is most appropriate for small areas and patching of areas where the grass is thin. In hydroseeding, seed is sprayed on the surface with a slurry of water. It is appropriate for most areas in excess of 5,000 square feet. Tackifiers, fertilizers, and fiber mulch are often added during this step. In drill seeding, a tractor-drawn implement actually injects seeds into the soil surface. Seeds are protected because they are covered by soil. This method is best suited for areas greater than two acres because it is cost prohibitive on a small scale. According to Northcutt (1993), drill seeding is about twice as expensive as broadcast seeding with mulch.

*Mulching*

Mulches are natural or synthetic materials spread on the soil surface to prevent erosion by intercepting and lowering the energy of falling rain. A variety of materials are available to accomplish this task, but they all operate on this same basic principle (see Table 4). The simplest way to improve the effectiveness of any mulch is to apply a thicker layer.

While compost mulch and wood chips can be useful in some circumstances, straw and fiber mulches are more commonly used, primarily because of their low cost. Both of these alternatives can be very effective (Table 1). While straw mulches provide a thicker cover to protect seeds and soil, fiber mulches are easier to apply.

Straw mulch is straw spread over the soil surface to prevent erosion. It can be effective alone or in combination with seeding (see Table 1), but needs to be secured to the soil surface. When straw mulch is not properly secured or "tacked" it can slide downslope

during large storms (Harding, 1990) or even be blown away. Four options to secure it are: 1) spraying a chemical tackifier, 2) using a tractor-drawn implement to "punch" the straw into the surface, 3) using a fiber mulch as a tackifier, and 4) covering the mulch with plastic netting.

Fiber mulches can be wood, paper or synthetic materials sprayed onto the soil surface. In general, wood fibers are the most effective erosion control mulches, and paper fibers should only be used for extremely short-term erosion control because they degrade quickly. Fiber mulches do not provide as

**Table 3: Tips for More Effective Seeding**

*Choose the right species:*

- For temporary cover, use fast growing species such as rye.
- Plant warm- or cold-season grasses behind on regional conditions.
- Use drought tolerant species in dry climates.
- Consider use of native species generally for increased longevity and hardiness.

*Provide an adequate growing environment:*

- Plant dense seed cover, based on local recommendations.
- Use soil test information to determine lime and fertilization requirements.
- Use mulch or blanket to protect seeds from animals, dehydration, cold and erosion especially when seeds are surface applied.
- Irrigate when necessary.

*Practices to avoid:*

- Hydroseeding in arid regions; grass will be poorly established.
- Seeding after the growing season ends. Instead apply a very thick mulch layer (about four tons/ac).

**Table 4: Mulching Alternatives**

Type	Description/ Uses
Straw or Hay	Straw or hay surface applied at two to four tons per acre Mechanically or chemically secured to the soil surface Provides the densest cover to protect seeds and soil
Wood Fiber	Chopped up fibers (usually wood) applied to the soil surface with a hydroseeder Tackifier is not always necessary, but can be applied with fiber, seeds and fertilizer in one step Effective erosion control, but not as dense a cover as straw mulch Best use is in combination with fast-growing seeds
Compost	Efficiency on par with wood floor Compost acts as a soil amendment Can act as a longer-term control (up to three years) Expensive compared with other mulches (about \$1/ square yard)
Wood Chips	Using wood chips as a mulch Effective when applied at high levels (about 6 tons/ acre) Can actually save money if on-site materials are used Effective on up to 35% slopes



R0079776

thick a cover as straw mulches and are generally more effective when used in combination with seeding. One major advantage is the ease of application: seed, water, mulch and a tackifier can all be applied on one step with a hydroseeder. Although using a tackifier is not always necessary, it can improve performance (Horner *et al.*, 1990) and only increases the cost of application by between one and two cents per square yard.

#### *Erosion Control Blankets*

Erosion control blankets are created when synthetic or organic fibers are held together with plastic netting. They are significantly more expensive than mulches, but can be used on steeper slopes than traditional mulches. Like mulch, they are most effective when combined with vegetative establishment.

While erosion control blankets can be effective, their performance varies. Some general trends are that organic materials tend to be the most effective (Harding, 1990) and that thicker materials are generally superior (Fifield, 1992), but there are exceptions to both of these rules. Information about product testing of blankets is generally lacking. One notable exception is the Texas Department of Transportation. They publish the findings of their testing program in the form of a list of acceptable and unacceptable materials for specific uses.

A recent alternative to traditional blankets is the use of spray-on blankets, which are three-dimensional matrices applied with a hydroseeder. They cost about the same amount as traditional blankets and are reported to provide similar erosion protection (Godfrey *et al.* 1994).

#### *Plastic Sheeting*

Plastic sheeting is a very simple erosion control technique, although not widely used. Plastic sheeting is only appropriate as a short-term control, and on very small areas. In order to be effective, the edges of the plastic need to be weighed down properly. Topsoil stockpiles are one example where plastic sheeting may be helpful. Since these piles are often disturbed within a few weeks, plastic sheeting, which can be frequently moved and reused, may be a good alternative.

Another synthetic erosion control technique effective in the short-term of about six months, is using *copolymers*. In this method, a synthetic material is applied in a mixture with water using a hydroseeder. The benefit of this approach is that it is effective for covering larger areas than plastic sheeting and it provides immediate cover. The best copolymers contain chemicals that increase flexibil-

ity, which prevents cracking that can cause failure. Like plastic sheeting, these semi-permeable covers also increase runoff volumes slightly.

#### *Sodding*

Sodding, another option to control erosion, is much more expensive than seeding. Sod provides immediate cover, but some evidence suggests that root establishment is shallower for seed grass than sod grass, causing higher nitrate leaching (Petrovic, 1990). The two best uses for sod are when final landscaping will include a sod lawn after construction or when immediate grass cover is needed, such as in an area of concentrated flow like a drainage way.

#### **Choosing the Right Erosion Control**

With the wide range of methods available to control erosion, choosing the right method for a specific application can be confusing. Too often, cost alone determines the erosion control method used. While cost is an important consideration, other site specific data need to be considered. Site factors related to soil quality, climate, flow velocity and construction activity can influence erosion control applicability (Table 5). Simple guidelines can dramatically improve erosion control, such as limiting planting to the growing season, and using erosion controls on slopes appropriate to their use.

In some geographic regions, effectively controlling erosion is almost always difficult. For example, the Pacific Northwest has winter conditions where vegetation cannot be established but intense rains cause a high erosion potential. Sites in this region need special "wet season" provisions such as very thick mulch cover on disturbed areas. In arid regions, establishing vegetation can be challenging for other climatic reasons. One adaptation specifically designed for these conditions is the use of "tracking." In this method, a heavy vehicle is driven perpendicular to the slope. The resulting impressions can trap limited water and organic material, increasing plant growth. Using spray-on chemicals for dust control is another important tool for erosion control in arid climates.

#### **Closing the Window**

The method of erosion control may often be less important than how quickly it is established and the extent of coverage. With most seeding operations, a window of at least two weeks exists from germination until production of a vigorous grass cover. This window may be further extended if a contractor waits a few days, weeks, or months to get started, or if the grass crop fails and needs to be restarted. During this time period, exposed soils are most vulnerable to

7

erosion. Although most ESC experts recognize the importance of limiting the *time* of disturbance, only 55% of the respondents to the Center's ESC write-in survey enforce time limits to vegetative establishment. Often, phrases like "as soon as practical" appear in vegetative establishment requirements. Cordova (1991) found such vague phrases to be a major stumbling block to effective ESC.

Although it is unreasonable to expect contractors to grow vegetation during a drought or outside the growing season, options are available to provide cover during this critical period. For example, a non-vegetative option such as mulch should be required outside the growing season.

**Conclusion**

The basic concept behind erosion control remains the same regardless of site conditions: cover the ground as quickly as possible to prevent erosion.

Covering the ground with the right material quickly enough is the hard part. Establishing specific materials guidelines and time limits is necessary to provide consistent erosion control. Only by following thoughtful, region-specific guidance can soil be preserved during the critical construction period.

-DSC

**Table 5: Erosion Control Options for Challenging Conditions**

Condition	Suggested Options for Erosion Control
Non-Growing Season	Straw mulch (2 tons/ac) Bark/compost mulch (4 to 6 tons/ac) Erosion control blankets Plastic sheeting
Poor Soils	Straw mulch Erosion control blankets Plastic sheeting Seeding or sodding with soil amendments, irrigation, and lime. Seeding with imported topsoil
Drought/ Arid	Straw mulch Erosion control blankets Drought tolerant seeds combined with tracking, irrigation
Steep Slopes	Erosion control blankets with seeding Compost or Bark mulch Plastic sheeting Sodding
Concentrated Flows	Erosion control blankets/ mats Sod checkdams to line channel
Frequent Disturbance	Plastic sheeting (preferred ) Temporary seeding



R0079778

## References

- Cordova, A.J. 1991. *The Effectiveness of a Sediment and Erosion Control Ordinance: Richland County, SC*. Master's Thesis. University of South Carolina. Columbia, SC. 142 pp.
- Fifield, J.S. 1992. "Comparative Evaluation of Erosion Control Products." In: *Proceedings: High Altitude Revegetation Workshop*. 10: 133-149.
- Godfrey, S.H., J.P. Long and J.A. McFalls. 1994. *The Performance of Flexible Erosion Control Materials and Hydraulic Mulches*. Texas Transportation Institute. Texas Department of Transportation. College Station, TX. 254 pp.
- Harding, M.V. 1990. "Erosion Control Effectiveness: Comparative Studies of Alternative Mulching Techniques." In: *Environmental Restoration: Science and Strategies for Restoring the Earth*. Island Press. Covello, CA 149-156.
- Horner, R.R. J. Guedry and M.H. Kortenog. 1990. *Improving the Cost Effectiveness of Highway Construction Site Erosion and Pollution Control*. Washington State Transportation Center. Federal Highway Administration. Seattle, WA. 79 pp.
- Lee, C.R., and J.G. Skogerbee. 1985. "Quantification of Erosion Control by Vegetation on Problem Soils." In: *Soil Erosion and Conservation*. Soil Conservation Society of America. Arkeny, IA. pp. 437-444.
- Northcutt, P. 1993. *A Practical Guide to the Establishment of Vegetative Cover on Highway Rights-of-Way*. Texas Department of Transportation. Austin, TX. 92 pp.
- Petrovic, A. 1990. "The Fate of Nitrogenous Fertilizers Applied to Turfgrass." *J. Environ. Quality* 19:11-14.
- U.S. EPA. 1992. *Storm Water Management for Construction Activities: Developing Pollution Prevention Plans and Best Management Practices*. EPA 832-R-92-005. Washington, D.C. 245 pp.
- W&H Pacific and CH2M-Hill. 1993. *Demonstration Project Using Yard Debris Compost for Erosion Control*. Portland Metropolitan Service District. Portland, OR. 99 pp.
- Wall, G.J. 1991. *The Effectiveness of Surficial Erosion Control Products*. Ontario Ministry of Transportation. Toronto, Ontario, Canada. 55 pp.

## Article 56

Technical Note #82 from *Watershed Protection Techniques*, 2(3): 424-428

# Strengthening Silt Fences

Silt fences are one of the most widely used and misused erosion and sediment control practices. Recent data suggest that they can perform well under some circumstances. In addition, their cost-effectiveness continues to make them a popular ESC technique. Unfortunately, silt fences are often used inappropriately or are improperly installed or maintained, resulting in poor performance. Simple improvements to the standard silt fence, as well as some innovative designs, can help to improve the current state of silt fences.

### How, and How Well, Do They Work?

Silt fences trap sediment in construction runoff before it washes into the street, a neighboring property or, in the worst case, a nearby stream or wetland. As sediment-laden runoff flows through the silt fence, the pores in the geotextile fabric filter out sediment particles. In

reality, settling is actually the most important sediment removal function of silt fences (Kouwen, 1990), since runoff is detained behind the fence, giving sediment time to settle out.

Three recent studies report sediment removal efficiencies ranging from 36 to 86% (Table 1). It is almost impossible to accurately predict the field performance of silt fences because relatively little research has been done, and the results are so variable. This being said, some useful information emerges from available data. First, these studies suggest that silt fences are more effective at removing coarser-grained materials. Conversely, silt fences are ineffective at reducing turbidity, which is disproportionately influenced by finer particles (Horner *et al.*, 1990). A second finding is that silt fences are less effective on steeper slopes.

Table 1: A Summary of Recent Performance Monitoring of Silt Fences

Study	Parameter	Efficiency	Description of Study Site
W&H Pacific and CH2M-Hill (1993)	TSS Turbidity	36% <sup>a</sup> -4.7% <sup>a</sup>	Average removal efficiency for five storms in March of 1993. Plot is on the 34% slope of a landfill. Soil is clay cap mixed with topsoil. Plot of bare soil is 32' by 9'.
W&H Pacific and CH2M-Hill (1993)	TSS Turbidity	65% <sup>a</sup> -1.5% <sup>a</sup>	Same study as above, but the test site is a 42% graded embankment with thick brown clay soil.
Horner <i>et al.</i> (1990)	TSS Turbidity	86% <sup>b</sup> 2.9% <sup>a</sup>	Construction site stockpile with a 24% slope. Gravelly sandy loam soil. Thirteen storms recorded over two winters on a 36' by 9' test plot.
Wyant (1993)	TSS	75% <sup>c</sup>	Efficiency determined by calculating sediment in a silty soil that will not settle after 25 minutes.







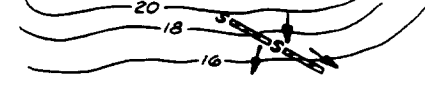
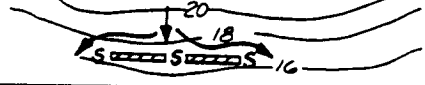
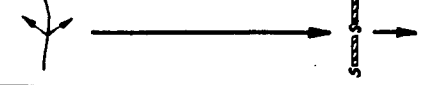

<sup>a</sup> Efficiency calculated as the average removal for all storm events

<sup>b</sup> Efficiency in reducing total loading for all storm events

<sup>c</sup> Theoretical maximum for silty soils based on settling rates

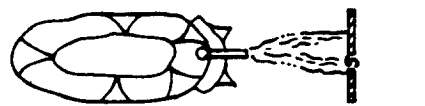
R0079780

Table 2: Conditions that Limit the Effectiveness of Silt Fences

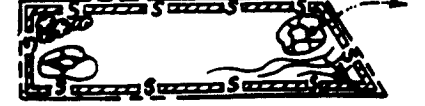
1		<p><b>Slope and/or Length of Slope</b>                      5% to 10%: no more than 50 feet                      10% to 20%: no more than 25 feet                      more than 20%: no more than 15 feet</p>
2		<p>Silt fence is not <b>aligned parallel</b> to slope contours</p>
3		<p>Edges of the silt fence are not <b>curved uphill</b>, allowing flow to bypass the fence</p>
4		<p><b>Contributing length</b> to fence is greater than 100 feet</p>
5		<p>Fabric is not <b>entrenched deeply</b> enough to prevent undercutting</p>
6		<p><b>Spacing between posts</b> is greater than eight feet</p>
7		<p>Fence receives <b>concentrated flow</b> without reinforcement</p>
8		<p>Installed <b>below an outlet pipe</b> or weir</p>
9		<p>Silt fence is <b>upslope</b> of the exposed area</p>
10		<p>Silt fence alignment does not consider <b>construction traffic</b></p>
11		<p><b>Sediment deposits</b> behind silt fence reduce capacity and increase breach potential</p>
12		<p>Alignment of silt fence <b>mirrors the property line</b> or limits of disturbance, but does not reflect ESC needs</p>

7

R0079781



### Why Are They So Widely Used?

Surveys consistently report that silt fences are one of the most widely used ESC techniques (Ohrel, 1996; Johnson, 1992). Their popularity can be explained by both technical, economic and social reasons.

Silt fences can be a cost-effective ESC technique. They are inexpensive (about \$3 per linear foot) and can be effective in trapping sediment when used appropriately. In addition, straw bales, their most common alternative, have been demonstrated to be almost completely ineffective. Many communities now specifically recommend that straw bales *not* be used by themselves, and some states such as North Carolina do not accept them on state projects. Consequently, silt fences are the most readily used perimeter control option in situations where other options such as diversion are not viable.

Silt fences are also popular because they have been so widely used in the past. Because developers and contractors feel they are familiar with the maintenance and installation requirements of silt fences, they can comfortably estimate the cost of using them on a project.

The visibility of silt fences is also a benefit. According to one survey respondent, they act as an "advertisement" for erosion and sediment control. In addition, this visibility sometimes makes inspection easier for both contractors and government inspectors.

### What Are Their Disadvantages and Limitations?

In a recent survey of ESC experts (Brown and Caraco, 1996), almost 90% of respondents recommended silt fences with reservations. Some problems related to both installation and maintenance of silt fences are described in Table 2. In a North Carolina survey, only 58% of silt fences were installed properly and a mere 34% were maintained properly (Pateron, 1994).

Silt fences require ongoing maintenance that can cost as much as the original installation (U.S. EPA, 1993). They are often damaged by construction equipment and storm runoff. Part of the regular maintenance of silt fences includes patching or repairing broken fences. In addition, the sediment trapped behind fences can reduce the volume available to store and treat runoff.

Because silt fences are a temporary, nondurable ESC technique, installing them to prevent damage and assure treatment of runoff is challenging. High flow volumes caused by large contributing areas or high velocities resulting from concentrated flows or steep slopes can damage silt fences. This permits runoff to flow through untreated. Runoff can bypass the fence when it does not flow perpendicular to the fence. Other errors in installation, such as improperly entrenching fabric, can also cause failure.

### How Can They Be Improved?

Although using silt fences effectively is challenging, some simple techniques can improve their performance (Table 3). Selecting the right materials

Table 3 Techniques and Materials to Improve Standard Silt Fences

#### Geotextile<sup>1</sup>

- Slurry flow rate lower than 0.3 cfs
- Tensile strength greater than 50 lbs/in
- Ultraviolet stability >90%
- Filtering efficiency >75%

#### Stakes/ Posts<sup>2</sup>

- Use wood stakes at least three inches in diameter or 2" X 4" and five feet tall or metal posts of 1.3 lb/ft

#### Installation

- Drive posts a minimum of 16" into the ground
- Embed geotextile in an 8"x8" trench
- Place stakes a maximum of eight feet apart, unless a wire backing is used (10 ft.)
- Maintain a ten-foot border between the silt fence and construction activity
- Install along contour lines
- Use a continuous sheet of geotextile to prevent failure at joints

#### Maintenance

- Check after every ½ inch storm and weekly
- Remove sediment when it reaches one half of fence height
- Patch torn fences, or replace the entire fence section when tears occur

<sup>1</sup> MDE, 1994

<sup>2</sup> Richardson and Wyant, 1987



R0079782

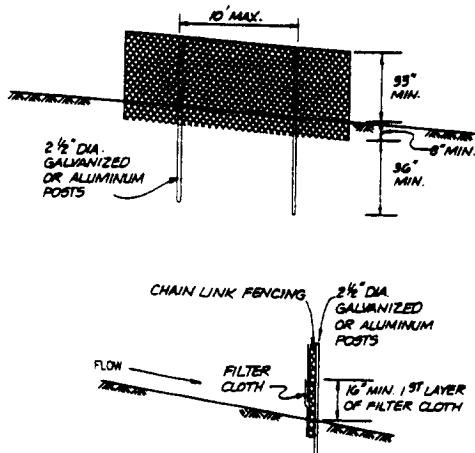

Super silt fence is a useful option on some construction sites where flow lengths or slopes are expected to be too stressful for normal silt fence.

Figure 1: Super Silt Fence

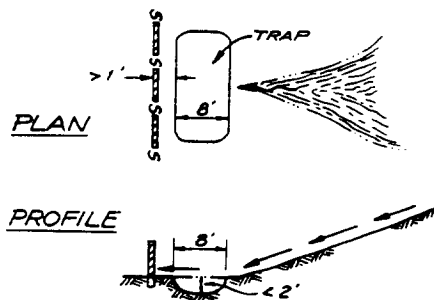

A scoop trap is a practical solution when silt fence is located at the toe of a steep slope.

Figure 2: Silt Fence with Scoop Trap

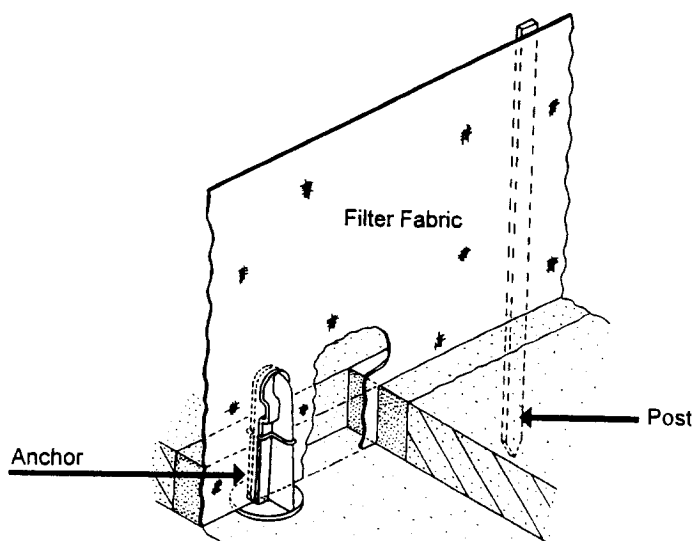

Anchors can be a remedy to prevent undercutting of silt fences, where site conditions make entrenching difficult.

Figure 3: Silt Fence Anchors

and fence designs are only one part of improving this technique. Education and common sense also play a strong role.

Silt fence fabrics are defined by standardized parameters that indirectly determine how strong the fence is, how much flow it can withstand and what size particle it can remove. The best materials are strong fabrics with low flow-through because they offer the greatest settling time. The recommendations in Table 3 represent some minimum guidelines for what can be confusing measurements.

The other material consideration is the poles that hold the fabric in place. A simple way to improve silt fences is to use thicker, longer posts and to place them closer together. These changes decrease the chance of fence failures and sagging, but also increase costs.

One recommendation to prevent damage to silt fences from construction activity is to include a minimum of a ten-foot grass buffer between construction activity and silt fences. Although this option may not be available on all sites, it can decrease damage to silt fences where applied.

Field performance ultimately can only be improved through a combination of enforcement and education on construction sites. For example, designers and plan reviewers should carefully outline conditions where silt fences should *not* be used (Table 2) and where other structural measures should replace them.

Perhaps the best way to improve silt fence performance is to practice effective erosion control. With proper erosion control, less sediment builds up behind silt fences. In addition, erosion control techniques lower runoff volumes, reducing the potential for failure.

### Beyond a Standard Silt Fence

In some watersheds, it may be necessary to radically change fence design. Three innovative or alternative methods to increase silt fence efficiency are described in Table 4. They include a "super silt fence," a "bucket trap" and "silt fence anchors."

The "super silt fence" (Figure 1), developed in suburban Maryland, utilizes a chain link fence to support the geotextile material. Although super silt fences are unlikely to structurally fail, they are about three times more expensive than traditional silt fences (\$9 per linear foot).

The "scoop trap" (Figure 2), also used in suburban Maryland, is a mini-sediment trap excavated with a tractor bucket placed before the silt fence at the point of concentration to provide additional ponding volume. Ordinarily, silt fences should not be applied in areas of concentrated flow. However,

**Table 4: Silt Fence Innovations**

Technique	Description
Super Silt Fence	Use of strong, thick geotextile backed by a chain link fence. The additional strength prevents failure.
Scoop Trap	A small sediment trap dug where flow concentrates. Provides additional detention volume.
Anchors	Plastic clips attached to the bottom of the geotextile to keep it entrenched.

at times when other preferred structural devices are not practical because of space constraints, scoop traps can be useful measures to protect the fence.

"Silt fence anchors" (Figure 3) are plastic clips that hold the fabric in the trench. The anchors are clipped to the bottom of the geotextile and then entrenched in the ground. Their purpose is to prevent fabric from being pulled out of the ground. However, these anchors have not been extensively field tested.

**Conclusion**

Silt fences are a deceptively simple practice. It is much easier to draw them as a straight line on construction drawings than to construct them at the site to really stop sediment.

When silt fences are planned and installed without careful thought the results are almost always poor. Also, once installed, silt fences tend to be forgotten and are perceived as a "no maintenance" practice. In reality, most silt fences will need extensive repair to function properly. We can expect little improvement in silt fence performance as long as they are perceived as a simple, mindless practice.

—DSC

**References**

Brown, W., and D. Caraco. 1996. *Task 2 Technical Memorandum: Innovative and Effective Erosion and Sediment Control Practices for Small Sites*. Center for Watershed Protection. Silver Spring, MD. 37 pp.

Horner, R.R., J. Guedry and M.H. Korten Hof. 1990. *Improving the Cost Effectiveness of Highway Construction Site Erosion and Pollution Control*. Washington State Transportation Center and the Federal Highway Administration. Seattle, WA. 79 pp.

Johnson, A.M. 1992. *Turf Establishment and Erosion Control*. Braun Intertec Pavement. Minnesota Local Road Research Board. Saint Paul, MN. 21 pp.

Kouwen, N. 1990. *Silt Fences to Control Sediment Movement on Construction Sites*. University of Waterloo. Ontario Ministry of Transportation. MAT-90-03. Ontario, Canada. 63 pp.

Maryland Department of the Environment (MDE). 1994. *Maryland Standards and Specifications for Soil Erosion and Sediment Control*. Baltimore, MD. 140 pp.

Ohrel, R.L. 1996. *Technical Memorandum: Survey of Local Erosion and Sediment Control Programs*. Center for Watershed Protection. Silver Spring, MD. 25 pp.

Paterson, R.G. 1994. "Construction Practices: The Good, the Bad and the Ugly." *Watershed Protection Techniques* 1(3): 95-99.

Richardson, and D.C. Wyant. 1987. *Geotextile Testing and The Design Engineer*. ASTM Special Technical Publication. 131 pp.

U.S. EPA. 1992. *Storm Water Management for Construction Activities: Developing Pollution Prevention Plans and Best Management Practices*. EPA 832-R-92-005. Washington, D.C. 245 pp.

U.S. EPA. 1993. *Guidance for Specifying Management Measures for Nonpoint Pollution in Coastal Waters*. EPA 840-B-92-002. Washington, D.C. 740 pp.

W&H Pacific and CH2M-Hill. 1993. *Demonstration Project Using Yard Debris Compost for Erosion Control*. Portland Metropolitan Service District. Portland, OR. 90 pp.

Wyant, D.C. 1993 *Developing VTM-51 Into an ASTM Test Method*. Virginia Transportation Research Council. Virginia Department of Transportation. Charlottesville, VA. 24 pp.



R0079784

## Article 57

Technical Note #83 from *Watershed Protection Techniques*, 2(3): 429-433

# The Limits of Settling

Sediment basins and traps face an imposing performance challenge in removing sediment from construction site runoff: massive incoming suspended sediment concentrations (Table 1). Field and modeling research indicate that average total suspended solids (TSS) concentrations from construction sites are about 4,500 mg/l (with some storms as high 17,500 mg/l). If a basin is capable of achieving an impressive removal rate of 90%, the basin would still discharge sediment at a concentration of 450 mg/l. This is noticeably muddy to any downstream observer. If a basin's removal rate is increased to 95%, the discharged TSS concentration is still 225 mg/l—again a highly turbid discharge by most standards. It takes a herculean removal effort—99% or more—to produce a TSS level (45 mg/l) that in any way resembles a clear water discharge. Is it realistic, then, to expect sediment basins to meet such an imposing performance challenge? This article reviews some recent field and

modeling studies to examine how much removal can practically be expected from sediment basins.

### Field Monitoring

Surprisingly few sediment basins and traps have been tested in the field. Of the limited number of performance monitoring studies that have been conducted, three of the most informative are Horner's (1990) study of three highway sediment basins in Washington state, Jarrett's (1996) Pennsylvania test basin study, and Schueler and Lugbill's (1990) study of five basins and traps in the suburban Maryland piedmont. These studies (entries 1 - 9 in Table 1) clearly suggest that basin removal rates are highly variable. A quick glance shows that three of the nine basins or traps were found to remove sediment at a rate above 94%, five basins were in the 55 to 85% range, and one trap removed less than 20% of incoming sediments (due to internal erosion at in-lets).

Table 1: The Performance of Sediment Basins and Traps  
A Summary of Field, Laboratory and Modeling Results

Research study or site	TSS (mg/l)		Mean % Reduction*
	Mean inflow	Mean outflow	
1. SR-204 <sup>1</sup>	3,502	154	98.6%
2. Seattle <sup>1</sup>	17,500	626	86.7%
3. Mercer Island <sup>1</sup>	1,087	63	75.1%
4. RT1 <sup>2</sup>	359	224	18.0%
5. RT2 <sup>2</sup>	4,623	127	99.8%
6. SB1 <sup>2</sup>	625	322	54.7%
7. SB2 <sup>2</sup>	415	91	80.3%
8. SB4 <sup>2</sup>	2,670	876	66.8%
9. Pennsylvania Test Basin <sup>3</sup>	9,700	800	94.2%
10. Georgia Model <sup>4</sup>	1,500 - 4,500	200 - 1,000	42 - 87%
11. Maryland Model <sup>5</sup>	1,000 - 5,000	200 - 1,200	68 - 99.5%
12. Uncontrolled Construction Site Runoff (MD) <sup>6</sup>	4,200	—	—
Means	4,498	365	75%

#### Sources:

<sup>1</sup> Horner et al., 1990

<sup>2</sup> Schueler and Lugbill, 1990

<sup>3</sup> Jarrett, 1996

<sup>4</sup> Sturm and Kirby, 1991

<sup>5</sup> Barfield and Clar, 1985

<sup>6</sup> York and Herb, 1978

\* Note: Based on mean of individual storm removals.

R0079785

**Table 2: Computer Model Estimates of Removal Efficiencies for Sediment Basins (Based on the 10-year, 24-hour Storm Event)**

Modeling Study	Geography and Soil Type	Removal Efficiency
Sturm and Kirby, 1991 Georgia Piedmont	Sandy loam	82 - 87%
	Silty loam	70 - 77%
	Clay loam	54 - 42%
Barfield and Clar, 1985 Maryland Coastal Plain	Silt loam	68 - 97%
	Clay loam	76 - 96%
	Sandy loam	94 - 99.5%
	Silt loam	68 - 97%
	Clay loam	76 - 96%

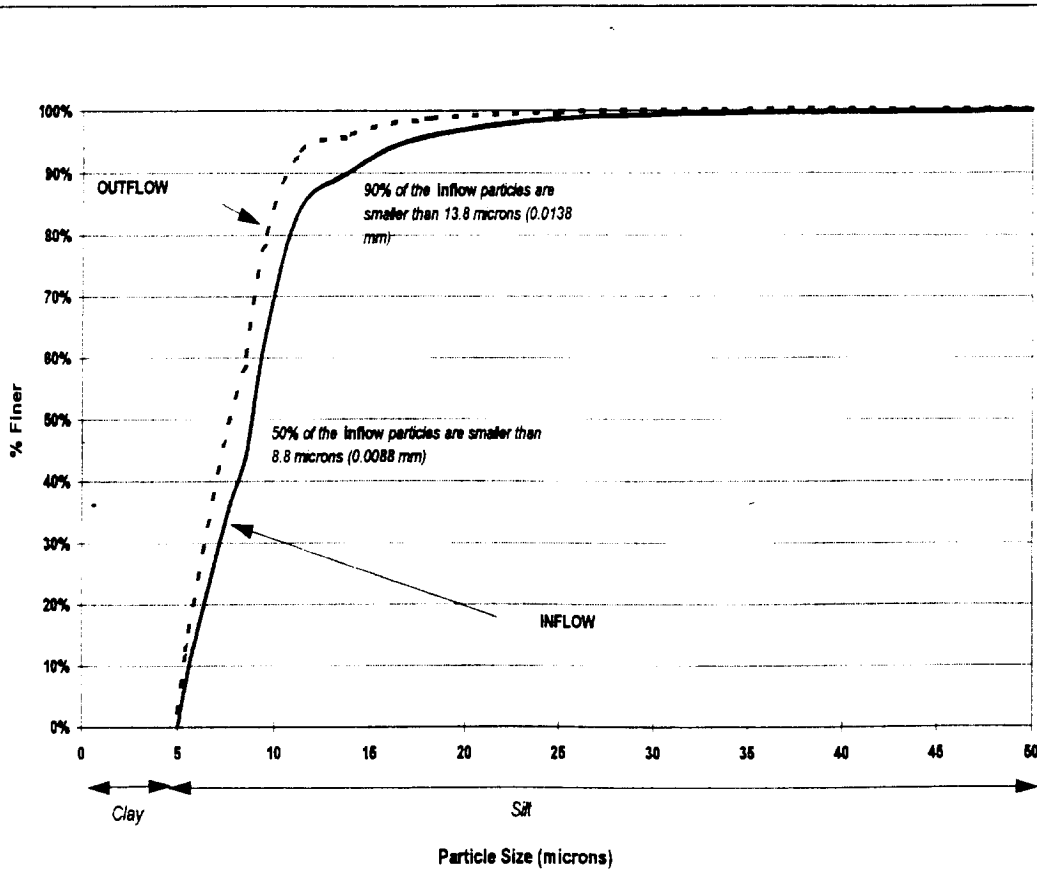

The particle size distribution becomes more fine-grained of sediment as it moves from inflow to outflow. Also, note that over 50% of all incoming sediments are less than 10 microns in size at this construction site in the Maryland piedmont, implying that a very small design particle should be chosen for design.

**Figure 1: Particle Size Distribution in Sediment Basin/Trap Inflow and Outflow (Schueler and Lugbill, 1990)**

7

R0079786

It is tempting to attribute removal rate variability to site and basin design differences. However, the removal rates for the basins and traps in the Schueler and Lugbill study varied significantly despite similar soil types, eroded particle soil size, and basin design criteria. A clear implication of the performance monitoring studies is that removal efficiencies are highly variable and that the current design of most basins is not capable of accomplishing the imposing challenge of 95 to 99% removal.

### Modeling Studies

Sediment basins and traps at active construction sites are notoriously difficult to sample. Runoff events are inherently unpredictable and construction site activity can interfere with data collection. Some researchers avoid these difficulties by using computer models to predict removal efficiencies. Some prominent examples include the work of Barfield and Clar (1985) and Sturm and Kirby (1991). In each case, the performance of sediment basins was assessed for a very large storm event (10-year, 24-hour storm) and for a series of parent soil types. The predicted removal efficiencies are summarized in Table 2. In general, both model studies suggest that sediment basins can reliably achieve a much higher performance level than reported in the field. What accounts for the discrepancy between model predictions and field results?

### Settling Theory Versus the Real World

Models and computer simulations used to estimate removal efficiencies use algorithms that simulate a behavior referred to as Type I settling. Three basic principles of Type I settling are (1) that the flow within the basin is quiescent; (2) that settling is governed by the particle size distribution of the incoming sediment (Stahre and Urbonas, 1990); and (3) that removal depends upon adequate detention time. "Real world" sediment basin design criteria require some practical and simplifying shortcuts. Most notably, a design particle is used to represent the spectrum of incoming sediment particle sizes.

Overall, the Type I settling theory is a good approximation of the complex settling process. The theory provides modelers with important insights into the mechanics of settling and allows researchers to examine and compare the relative merits of different basin designs while avoiding the vagrancies of field conditions.

The disconnect between models and reality occurs when we forget that the theory cannot capture the full complexity of flow, adequately reflect particle size distributions observed in the field, nor anticipate the sporadic, turbulent nature of runoff events.

### Complex Flow Patterns

Type I settling theory assumes quiescent flow conditions. Between runoff events, any water within sediment basins is assumed to be static and calm. During runoff events, however, basins may experience multilayered flow, turbulence, eddies, circulation currents, dead spaces and diffusion at outlets and inlets. These factors lessen the removal capability of the basin, particularly with respect to the very small particles (i.e., silts and clays) that often dominate construction site runoff.

### The Design Particle: Smaller Than You Think

The design particle is a convenient representation of the entire range of incoming sediment particles. Sediment particle sizes range from big, bulky cobbles to microscopic fine clays (Table 3). The design particle used for sediment basin design is generally based on a larger particle, such as sand. The particle size distribution of incoming sediment to basins and traps, however, is typically skewed toward finer-sized particles (Figure 1) and is usually much finer than that of the parent soil. This shift toward finer-sized particles occurs because less energy is usually required to detach, entrain, and transport smaller particles in the overland flow from construction sites, in comparison to larger particles.

Finer-sized particles tend to behave as non-settleable solids. The electrostatic forces generated by their extremely small size tends to impede settling. It is very difficult to effectively remove most particles less than 10 microns in size (i.e., silts and clays) by sedimentation alone. Many of the smaller particles that enter sediment basins are eventually discharged from the same basin. In fact, the particle size distribution of discharge from basins and traps is typically dominated by fine-silts and clays (Figure 1).

### Detention Time

Detention time is the amount of time that runoff remains in the basin to allow sediment to settle out. For a sediment particle to settle out, it must reach the bottom of the sediment basin before the water is discharged. The speed of the sediment particle as it falls to the basin bottom is the particle's *settling velocity* and different sized particles settle out at different rates. Larger grained particles tend to settle out relatively swiftly. On the other hand, finer-sized particles have slower settling velocities and tend to remain suspended in the basin.

The settling velocity of the design particle is a key component of basin design. In an ideal situation, discharge from the basin would not begin until the design particle had settled out. Particles with settling velocities greater than the design velocity

will be completely removed. Particles with slower settling velocities will be removed in the following ratio:

$$\frac{\text{actual settling velocity}}{\text{design settling velocity}}$$

Theory implies that longer detention will provide greater removal efficiencies. However, field and laboratory data have shown that most settling occurs within the first few hours and that little additional settling is gained by increasing the detention time. As much as 60% of the total removal is accomplished within the first six hours (Schueler and Lugbill, 1990) and additional increments of sediment removal are more difficult to obtain after the rapid initial settling.

### Bringing It Together

What can be done to make field performance more closely match theoretical performance criteria? Based on our comparison of model studies and field monitoring results, the key is to re-examine sediment basin design theory and application by focusing on increased removal of smaller particles. Some steps toward this goal include the following:

#### Select Smaller Design Particles

Most basin designs begin with a design particle. Unfortunately, the design particle is usually more representative of the parent soil rather than the basin inflow. To obtain a more accurate design particle, field monitoring data or modeling studies can be used to obtain the particle size distributions. Selecting smaller design particles, more in line with silt and clay dominated runoff, should yield a more realistic settling velocity.

#### Provide More Storage

The connection between large storms and basin volume is very straightforward: the larger the basin, the more runoff that can be detained and the longer the detention time. However, as discussed in article 58, during larger storms, a significant portion of the runoff is being displaced from basins or is discharged prematurely because many basins are undersized. In such cases, the runoff from larger storms can be accommodated with extra storage. The extra storage should be of sufficient volume to ensure a minimum of two to six hours of detention during larger storms.

Extra storage will also improve basin performance during small, frequent storms. Detention time is really the issue during these smaller storm events. Because these storms occur more frequently, it is more likely that runoff from these events may be discharged prematurely, before settling has been completed. Extra storage allows runoff from frequent storm events to be detained instead of being pushed out by the influx of additional runoff.

#### Decrease Incoming Sediment Loads

The best way to decrease the amount of sediment leaving basins and traps is to reduce the amount of sediment entering them. This common-sense approach to sediment control has been echoed by many erosion and sediment control experts across the country (Brown and Caraco, 1996).

### Summary

It is evident that while models are very useful in describing the fate of coarse-grained sediment particles under ideal settling conditions, they have a very limited ability to simulate the very complex settling dynamics associated with fine-grained and



Table 3 Sediment Particle Sizes According to the U.S. Department of Agriculture

Sediment Particle Size Class	Particle Size (mm)	(microns)
Cobbles and boulders	> 10	>10,000
Gravel	2 - 10	2,000 - 10,000
Very coarse sand	1 - 2	1,000 - 2,000
Coarse sand	.5 - 1.0	500 - 1,000
Medium sand	0.25 - 0.50	250 - 500
Fine sand	0.10 - 0.25	100 - 250
Very fine sand	0.05 - 0.10	50 - 100
Silt	0.002 - 0.05	2 - 50
Clay	< 0.002	<2

R0079788

colloidal particles. Consequently, the high sediment removal rates for basins computed by such models need to be taken with a grain of salt. It does seem that the basic design of sediment basins and traps can be improved and made more reliable, but there are limits to settling. It is safe to assume that a 80 to 90% removal rate is probably the best that can be achieved under field conditions. Likewise, we should acknowledge that most sediment basins cannot reliably meet a "clear water" discharge concentration.

—WEB

#### References

- Barfield B.J., and M. Clar. 1985. *Development of New Design Criteria for Sediment Traps and Basins*. Prepared for the Maryland Resource Administration. Annapolis, MD. 33 pp.
- Brown, W., and D. Caraco. 1996. *Task 2 Technical Memorandum: Innovative and Effective Erosion and Sediment Control Practices for Small Sites*. Center for Watershed Protection. Silver Spring, MD. 37 pp.
- Canale, R. P. and J. A. Borchardt. 1972. "Sedimentation." In: *Physicochemical Processes for Water Quality Control*. John Wiley & Sons. pp. 111-138.
- Horner, R.R., J. Guedry and M.H. Kortenhoff. 1990. *Improving the Cost Effectiveness of Highway Construction Site Erosion and Pollution Control*. Washington State Transportation Center and the Federal Highway Administration. Seattle, WA. 79 pp.
- Jarrett, A. 1996. *Sediment Basin Evaluation and Design Improvements*. Pennsylvania State University. Prepared for Orange County Board of Commissioners. 77 pp.
- Schueler, T. 1995. *Site Planning for Urban Stream Protection*. Center for Watershed Protection. Silver Spring, MD. 232 pp.
- Schueler, T., and J. Lugbill. 1990. *Performance of Current Sediment Control Measures at Maryland Construction Sites*. Metropolitan Washington Council of Governments. 90 pp.
- Stahre, P., and B. Urbonas. 1990. *Stormwater Detention for Drainage, Water Quality, and CSO Management*. Prentice Hall. Englewood Cliffs, NJ. 338 pp.
- Sturm, T. W., and R.E. Kirby. 1991. *Sediment Reduction in Urban Stormwater Runoff from Construction Sites*. Georgia Institute of Technology. Atlanta, GA. 104 pp.
- York T.H., and W.J. Herb. 1978. *Effects of Urbanization and Streamflow on Sediment Transport in the Rock Creek and Anacostia River Basins*. Montgomery County, MD, 1972-1974. U.S. Geological Survey Professional Paper No. 1003. 72 pp.



R0079789



## Article 58

Technical Note #84 from *Watershed Protection Techniques*, 2(3): 434-439

# Improving the Trapping Efficiency of Sediment Basins

Sediment basins that are designed to settle out suspended sediments in stormwater runoff are typically the last line of defense at construction sites. Many communities employ the same basic and fairly simple design specification for sediment basins (see Table 1). While most specifications refer to optional design features such as de-watering devices, baffles or perforated risers, these "extras" are seldom installed in the field for cost reasons. In practice, the criteria are often used to tell the contractor how much dirt needs to be scooped out to provide the requisite storage.

Consequently, in many regions, sediment basins are really no more than engineered holes in the ground (HIGs). HIGs can be seen at almost any construction site around the country: steep-sided rectangular holes, that may or may not have standing water, with a ring of bright orange safety fencing, a reusable corrugated metal pipe (CMP) riser and perhaps a truckload of rip-rap dumped near the outlet.

It is not surprising, then, that most HIGs are a poor settling environment, and few are probably capable of consistently removing 70% of incoming sediment, much less the 95 to 99% removal needed to achieve a relatively clear water discharge. A large number of factors work to reduce the trapping efficiency of a basin in the field (Table 2), some of which could conceivably be "engineered away" through better design. Thus, the key question is this: How

much improvement in performance can be expected if the basic design of sediment basins is modified?

A steady stream of sediment basin design improvements have been advocated over the years, including perforated risers, perforated risers with gravel or filter fabric jackets, filter fence baffles, floating skimmers, "dual basins in series," greater storage volumes and various combinations thereof (see Figure 1). Until recently, however, these design improvements were seldom subjected to experimental testing or field monitoring to determine if they actually improved trapping efficiency. Lacking proven performance data, many local and state erosion programs have been reluctant to adopt these improvements, given the potential cost and maintenance ramifications.

### Sediment Basin Re-Design

Our understanding about the performance of innovative sediment basin designs has recently been increased by a series of laboratory experiments, field monitoring and modeling studies conducted by A. R. Jarrett and his colleagues at Pennsylvania State University and Rich Horner of the University of Washington. While it is difficult to make direct comparisons between studies because of differences in soils, rainfall, design storage and experimental techniques, the research does offer some insight into these innovative techniques.

Table 1: "Standard" Sediment Basin Design Criteria Compiled from Various State and Local ESC Manuals

- Provide 1,800 cubic feet of storage per contributing acre \*
- Surface area equivalent to one percent of drainage area \*\*
- Riser w/ spillway capacity of 0.2 cfs/acre of drainage area (peak discharge for two-year storm, undeveloped condition)
- Spillway capacity to handle 10-year storm with one-foot freeboard
- Length-to-width ratio of two or greater \*\*
- Basin sideslopes no steeper than 2:1 (h:v)
- Safety fencing, perforated riser, de-watering \*\*

\* A number of states (MD, PA, GA and DE) recently increased storage requirement to 3600 ft<sup>3</sup> or more.

\*\* Optional technique, but seldom actually required during plan review.

R0079790

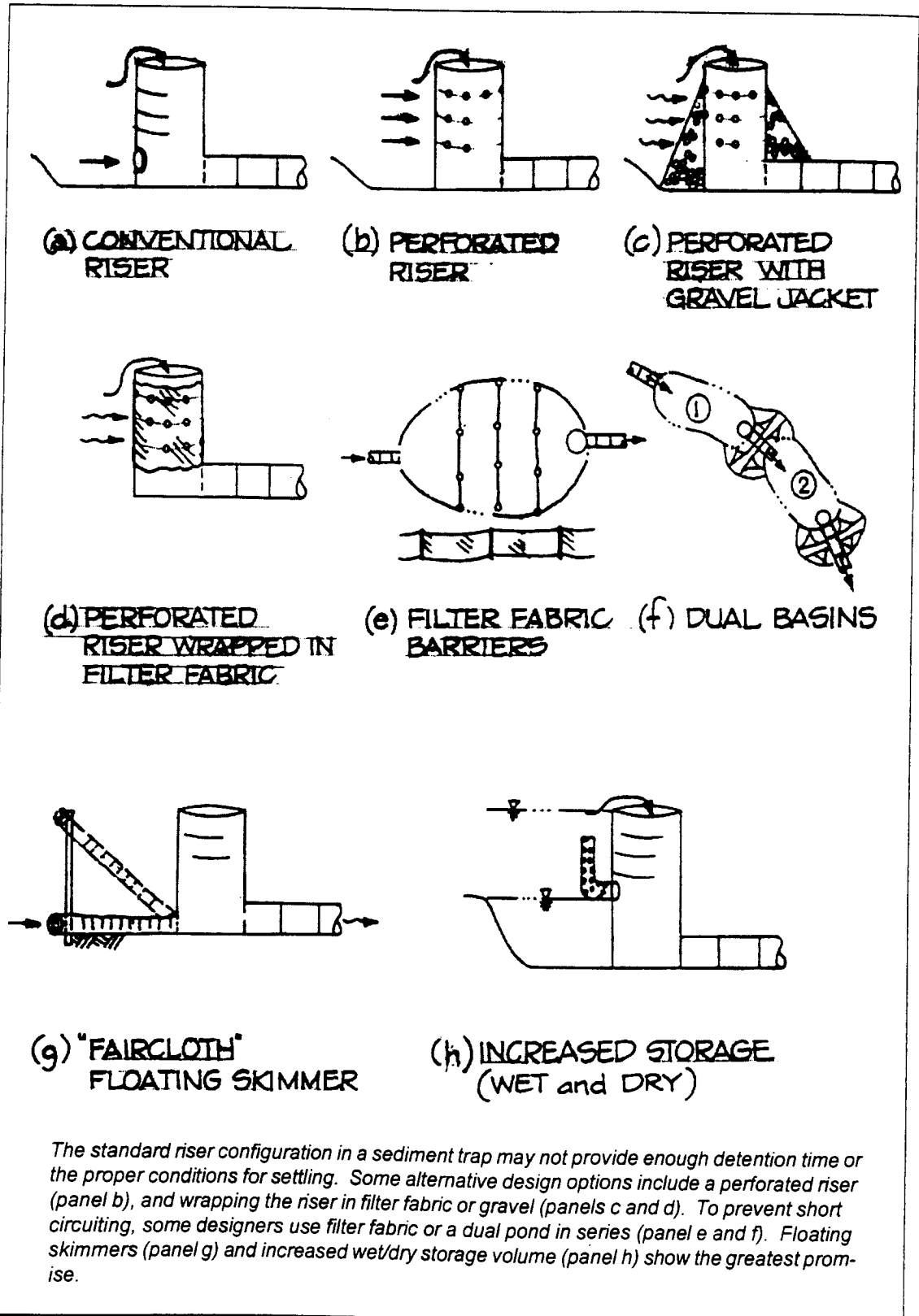
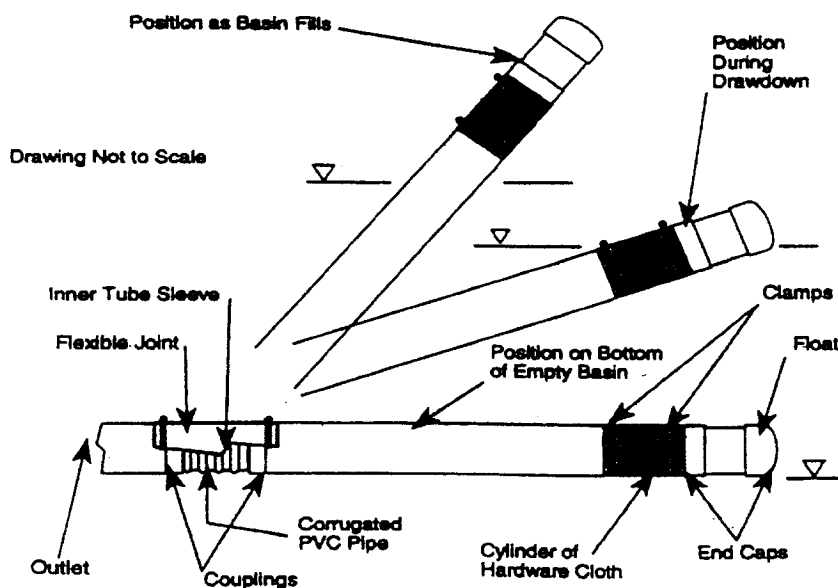

Figure 1: Options for Design Improvements

**Table 2: Factors that Impair Trapping Efficiency of Sediment Basins and Traps**

**Factors that Impair Trapping Efficiency**

- Large storm events (greater than two-year storm)
- Moderate to low incoming TSS concentrations
- Sediment deposits on bottom are re-suspended, or sides erode
- Fine particle sizes in incoming runoff (silt and clay particles 40 microns or less)
- Advanced stage of construction, with storm drains and paved roadways increasing runoff volume/velocity
- Low intensity, long duration rainfall events
- Length-to-width ratio of 1:1 or less
- Multiple inlets, particularly if not stabilized or if their invert is more than a foot above basin floor
- Steep side-slopes, particularly in non-growing season or poor vegetative cover
- Turbulent energy in runoff
- Cold water temperatures (below 40 degrees F)
- Absence of standing water in basin
- Upland soils are in C and D hydrologic soil groups, or highly erodible soils



7

**Comments:**

- Barrel pipe is 10.2 cm (4 in) schedule 40; float is lightweight drainage pipe.
- Barrel pipe length should be slightly longer than the depth of basin to crest of principle outlet.
- Corrugated PVC pipe in flexible joint prevents inner tube sleeve collapsing under water pressure.
- Outlet pipe is fitted with an end cap with a small hole (size varies with volume of basin) to restrict outflow and maximize sedimentation, typically .5 to .75 inch diameter.
- Fence posts are placed on both sides of skimmer as guides; wire across the top limits floating and can be used to stop and sink skimmer when water level reaches desired elevation.

*The floating skimmer rests on the floor of a sediment basin in between storms. The float causes the skimmer to rise during a storm, thereby increasing detention time and withdrawing from the less turbid surface waters.*

**Figure 2: Floating Skimmer Design (Faircloth, 1995)**

**R0079792**

*Perforated Riser.* A simple means of achieving greater detention times is to replace the standard riser (with its large flow orifice) with a perforated riser (see Figure 1). The perforations should slightly increase detention times in the basin for smaller storms, and therefore increase trap efficiency. In practice, the effect of a perforated riser on detention time and basin hydraulics is poorly understood, although an excellent design methodology has been proposed by Jarrett (1993). Test tank research has shown that the perforated riser, by itself, only results in sediment removal on the order of 60 to 70%, depending on the de-watering time achieved (Table 3; Engle and Jarrett, 1995). The perforated riser was generally unable to settle out fine-grained silt and clay particles, which accounted for the mediocre removal rate.

*Perforated Riser with Gravel Jacket.* The use of a "jacket" of gravel around the perforated riser has been used in some communities to provide more filtering, further increase detention times, and promote greater settling. The experimental work of Engle and Jarrett generally supports this notion (Table 3). Sediment removal increased by 15 to 18% compared to a perforated riser alone. The same authors found that encasing the riser with expanded polystyrene chips (EPS), similar to those used in packing, had the same effect on trapping efficiency, as well.

*Perforated Riser with Filter Fabric Lining.* The use of gravel jackets can be fairly expensive, can lead to clogging, and may make maintenance operations more difficult. As an alternative, several communities allow a layer of permeable filter fabric to be wrapped around the outside of the perforated riser. Based on experimental tests of Fisher and Jarrett (1984), however, this approach is not likely to increase trapping efficiency much. Of six fabrics tested, none performed well in trapping silt and clay particles, although most fabrics did prevent sand from passing through. Also, field experience has shown that the pores of filter fabric clog very rapidly, transforming the fabric from a filter to a barrier. When filter fabric clogs, basins tend to fill up with water to the crest of the riser, thereby losing valuable storage capacity.

Recent experiments by Brown (1997) using two types of filter fabric on a perforated riser, where the uncovered perforated riser had a 48-hour de-watering time, showed that the filter fabric clogged quickly, greatly extending the de-watering time. In addition, the particle size distribution of suspended sediment passing through the filter fabric was essentially the same as measured for the influent.

*Silt Fence Barriers.* To achieve the desired length-to-width ratio of 2:1 or 5:1, some communities require that baffles or silt fence barriers be placed perpendicular to the flow path within a sediment basin. Experiments by both Millen and Jarrett (1996) and Horner *et al.* (1990) found silt fence barriers to be of relatively little value in improving sediment removal in test basins, primarily because they had little or no influence on detention time (see Table 4). Dye tests reported by Jarrett (1996) did show that the barriers reduced short-circuiting to near zero, but tended to increase the volume of dead storage in the basin. Poorly-mixed dead storage zones provide less detention time for incoming sediments as they move from inlet to the riser. The research implies that while baffles are important in basins with multiple inlets or poor geometry, they provide only a marginal sediment removal benefit for a well-designed basin.

*Faircloth "Floating Skimmer."* The floating skimmer was developed by William Faircloth of Orange County, North Carolina (Faircloth, 1995). The simple, inexpensive device consists of a straight section of PVC pipe attached via a flexible coupling to the low-flow outlet situated at the base of a riser (see Figure 2). Equipped with a float, the skimmer pipe will rise and fall along with water levels in the sediment basin. The inlet to the skimmer pipe is a small hole located at the end-cap (this small hole, often only 1/2 to one-inch in diameter, restricts flow, and therefore increases detention time). Fence posts are driven in on both sides of the skimmer pipe, guiding it up and down.

Table 3: Effect of Riser Configuration on Sediment Basin Removal Efficiency (Engle and Jarrett, 1995)

Riser Configuration	TSS Removal 1.5 hour dewatering time	TSS Removal 3.0 hour dewatering time
Perforated Riser (PR)	59.8%	71.0%
PR w/ Gravel Filter	78.3%	85.6%
PR w/ EPS Chips Filter	78.3%	89.0%

*Test Conditions:* experimental settling tank, 18 trials, initial TSS concentration of 5880 mg/l; particle size distribution 24% clay, 35% silt, and 41% sand.

**Table 4: Effect of Design Features on Sediment Basin Trapping Efficiency**  
(Jarrett, 1996)

Basin Design Feature	Sediment Removal
Perforated Riser	94.2%
Perforated Riser w/ Barriers	95.4%
Skimmer on PR	96.9%
Skimmer on PR, w/ Barriers	96.6%

*Test Conditions: full-scale sedimentation basin, one-acre construction site, 6250 ft<sup>3</sup> capacity, two-year, 24-hour rainfall event, peak inflow Q<sub>p</sub> of 0.83 cfs, 12 trials, 2000 to 5000 mg/l average TSS inflow; particle size distribution: 6% clay, 21% silt, 51% sand, 22% gravel.*

Prior to the storm, the skimmer pipe rests on the floor of the sediment basin. During the first part of a storm, the inlet hole restricts flow, backing water up in the basin, and causing the skimmer pipe to rise. Sediment-laden runoff encounters a permanent pool which promotes greater settling. After the storm, the basin gradually de-waters, and the skimmer slowly descends back to the floor of the basin. This de-watering allows full recovery of storage capacity in the sediment basin for the next storm. In addition, the skimmer is always drawing cleaner runoff near the top of the pool, rather than the dirtier bottom sediments.

Several prototypes have been tested in the Chapel Hill, North Carolina region, and Faircloth reports that they appear to perform well and are very durable. In addition, the cost of the skimmer is less than \$100, and is comprised of readily available materials. The performance of the floating skimmer was recently tested under simulated field conditions by Jarrett (1996). Nearly 97% of sediment removal was achieved by the test basin during a simulated two-year, 24-hour design storm event (Table 4), the highest trapping efficiency observed for any of basin designs tested. The trapping efficiency of the floating skimmer appears to be ultimately limited by turbulent energy of incoming runoff. According to Jarrett (1996), fine-grained particles (smaller than 45 microns) are not subject to effective settling when turbulent energy exceeds 0.3 feet per second, which is quite common in many basins.

*Dual Basins.* A promising, if not always practical, means of improving sediment basin efficiency is to split the total storage volume into two basins in series rather than one. Laboratory experiments by Horner *et al.* (1990) suggested that a dual basin arrangement was the single most effective design strategy to increase detention time, and therefore, settling potential (i.e., greater than baffles or increasing basin length). While this option is certainly more expensive than others, it may be appropriate for highway and

other development sites that have long and narrow areas available for treatment.

*Increase Storage Volume.* Several states such as Maryland, Georgia and Delaware have increased the storage capacity of sediment basins from the traditional 1800 ft<sup>3</sup> per acre (i.e., one-half inch over contributing watershed area) to 3600 ft<sup>3</sup> /acre. The extra storage and changes to the basin's outlet should increase the detention times for many storms, particularly those less than one-inch deep. For smaller storms, it may be possible to achieve "zero discharge" during a storm event if it is smaller than the capacity of the basin. It is important to note that the expected improvement in efficiency will not occur unless the principal spillway is also modified to increase detention at the same time. This is done by raising or constraining the low-flow orifice, creating a partial permanent pool with a riser elbow modification, or using the floating skimmer or perforated riser (Jarrett, 1996; McBurnie *et al.*, 1990; Schueler and Lugbill, 1990). Further, it should be noted that the effect of increasing storage volume on basin efficiency has not yet been documented experimentally in the lab or the field, although anecdotal evidence suggests that it produces more zero discharge events than the old criteria.

**Summary: Recommended Basin Design Specifications**

While a large number of sediment basin design refinements are being promoted, current research suggests that some may not substantially improve performance. In addition, more field research is needed under a wider range of construction site conditions to accurately assess which design refinements are worth adopting. In particular, the value of the basin design improvements in capturing extremely-fine grained sediments needs more assessment. Further, new design refinements must be carefully assessed from the standpoint of future maintenance and contractor expertise—an overly complex design refine-



R0079794

Table 5: Recommended Sediment Basin Design Criteria

- 1 Provide a minimum storage of at least 3,600 ft<sup>3</sup> per acre.
- 2 Provide storage in wet and dry stages.
- 3 Require silt fence barriers if length to width ratio is less than two.
- 4 Evaluate all proposed inlets for stability.
- 5 Employ a floating skimmer, or at least a perforated riser w/ gravel jacket.
- 6 Incorporate storage in multiple cells, where possible.
- 7 Limit side-slopes to no greater than 3:1.
- 8 Check water table to determine if basin can/should fully de-water.
- 9 Paint depth markers on principal spillway to measure sediment deposition to better trigger cleanouts.
- 10 Stabilize side-slopes and basin bottom with mulch or hydroseeding within one week.

ment that works great in the lab may be difficult to construct or maintain in the field. Lastly, if the design refinements greatly increase the cost of sediment basins, it is probable that many designers will shift to cheaper (and presumably less effective) sediment controls that are available in the local ESC handbooks. With these considerations in mind, some possible refinements to traditional sediment basin design criteria are proposed in Table 5.

—TRS

#### References

- Brown, E.R. 1997. *Filtering Efficiency and Water Transmissibility of Geotextiles Utilized in the Design of Sedimentation Discharge Riser Pipes*. Unpublished MS Thesis. Civil Engineering, Pennsylvania State University, University Park, PA.
- Engle, B.W and A.R. Jarrett. 1995. "Sedimentation Retention Efficiencies of Sedimentation Basin Filtered Outlets." *Transactions of ASAE* 38(2): 435-439.
- Faircloth, W. 1995. *Experimental De-watering Device to Improve Sedimentation Basin Efficiency*. Unpublished manuscript. Orange County Planning and Inspections Dept. Hillsborough, NC. 12 pp.
- Fisher, L., and A.R. Jarrett. 1984. "Sediment Retention Efficiency of Synthetic Filter Fabrics." *Transactions of ASAE* 27(2): 429-436.
- Horner, R., J. Guedry, and M. Kortenhoff. 1990. *Improving Cost-Effectiveness of Construction Site Erosion and Pollution Control*. Washington State Dept. of Transportation. WA-RD-200.1 Seattle, WA. 64 pp.
- Jarrett, A.R. 1993. "Design of Perforated Risers to Control De-watering of Sedimentation Basins." *Transactions of ASAE, Applied Engineering in Agriculture* 9(1):37-42.
- Jarrett, A.R. 1996. *Sedimentation Basins: Evaluation and Design Improvements*. Final Report. Orange County Planning Commission. Pennsylvania State University. 77 pp.
- McBurnie, J., B. Barfield, M. Clar, and E. Shaver. 1990. Maryland Sediment Detention Pond Design Criteria and Performance. *Applied Engineering in Agriculture* 6(2): 167-172.
- Millen, J.A., and A.R. Jarrett. 1996. *Improved Sedimentation Basin Performance with Barriers and a Skimmer*. ASAE Microfiche No. 96-2056.
- Schueler, T., and J. Lugbill. 1990. *Performance of Current Sediment Control Measures at Maryland Construction Sites*. Metropolitan Washington Council of Governments. Washington, D.C. 90 pp.

R0079795

# Performance of Sediment Controls at Maryland Construction Sites

**S**ediment traps or basins, common features at most construction sites, represent the last line of defense against soil erosion. Sediment particles that do not settle out in the trap or basin will soon reach a stream. Although sediment traps and basins have been used for decades, research on their actual field performance is scarce. Aren't these traps just "muddy water in, muddy water out, and a lot of money in between?"

Some answers to this question can be found in a study of six sediment traps and basins in Maryland. The construction sites were located in both the piedmont and coastal plain and were well served with erosion control measures (temporary seeding, perimeter controls such as dikes and silt fence, and construction

phasing). Soils at each site were silt loams, and each trap or basin served a contributing drainage area of 11 to 35 acres. Construction site runoff entering the basins and traps was heavily laden with suspended sediment (median concentration of 680 mg/l, with a range of 24 to 51,800 mg/l). A particle size analysis indicated that sediment was very fine grained, primarily consisting of silts, clays and colloidal material. Ninety percent of all particles were less than 15 µm diameter, and no particles were found with a diameter >50 µm (coarse silt or fine sand).

Performance monitoring at construction sites is not an easy task. A construction site is never the same from month to month, and each storm creates an ever-changing series of channels and gullies that contribute runoff and

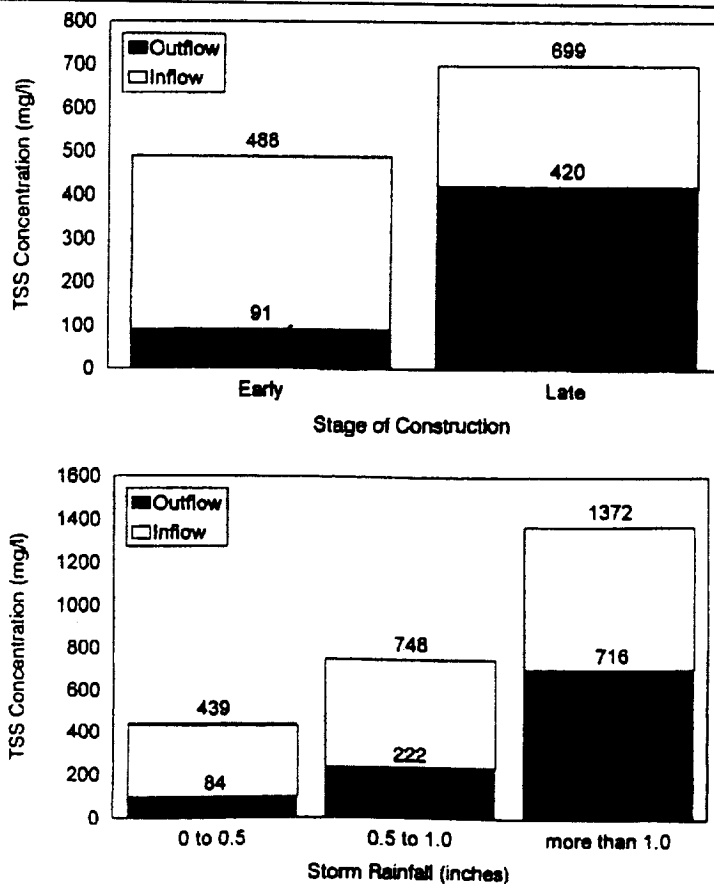

Figure 1: Effects of Construction Stage and Storm Size on TSS Levels in Sediment Traps and Basins



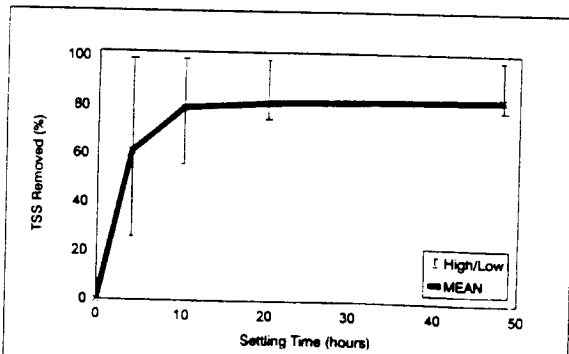

Figure 2: Effect of Settling Time on Sediment Removal Rate—Mean of 12 Settling Column Trials

sediment at multiple points. Thus, it is not generally possible to obtain a reliable primary flow measurement to estimate the mass of sediment delivered into the basin or trap. Consequently, an alternative and less powerful sampling protocol had to be utilized. Multiple grab samples were collected at the inlets and the outlet during a large number of storm events. A total of 230 grab samples were taken during nine storm events to compensate for the inaccuracy of the grab sampling approach. Sediment removal was defined as the difference in mean inflow and outflow concentrations during each storm event.

The overall performance of the basins and traps in removing suspended sediment averaged 65% for all nine storm events (range: -273% to +100%). This estimate, however, included numerous small storms

which produced flow into the trap or basin but none out of it. When only the storms that produced outflow were considered, sediment removal performance for traps and basins dropped to 46%. Highest removal rates were noted when the construction site was in an early stage of construction, and for smaller storms (<0.75 inches of rainfall) (Figure 1). Poor performance was consistently noted for construction sites in a more advanced stage of construction (particularly after the storm drains had been installed) and during larger storms (0.75 inches of rainfall or more).

A series of 12 laboratory settling column trials confirmed the difficulty of removing the extremely fine-grained construction site sediment particles (Figure 2). While an average of 60% of suspended sediments settled out within the first four hours, additional removal was difficult to achieve. For example, it took an average of six more hours to get the next 18% increment of sediment removal (78% total). Another 10 hours of settling (20 hours total) only removed 2% more sediment (for a total of 80%). Two days of settling in the ideal settling column environment resulted in 90% sediment removal. Particle size analysis indicated that the sediments that still remained in suspension after 48 hours were extremely fine clays and colloidal materials that were highly resistant to further settling. The field study indicated that the outflow from sediment traps and basins was still quite turbid (mean of 200 NTUs) and sediment-laden (mean concentration of 283 mg/l).

The inconsistent performance of sediment controls noted in the study highlights the critical importance of

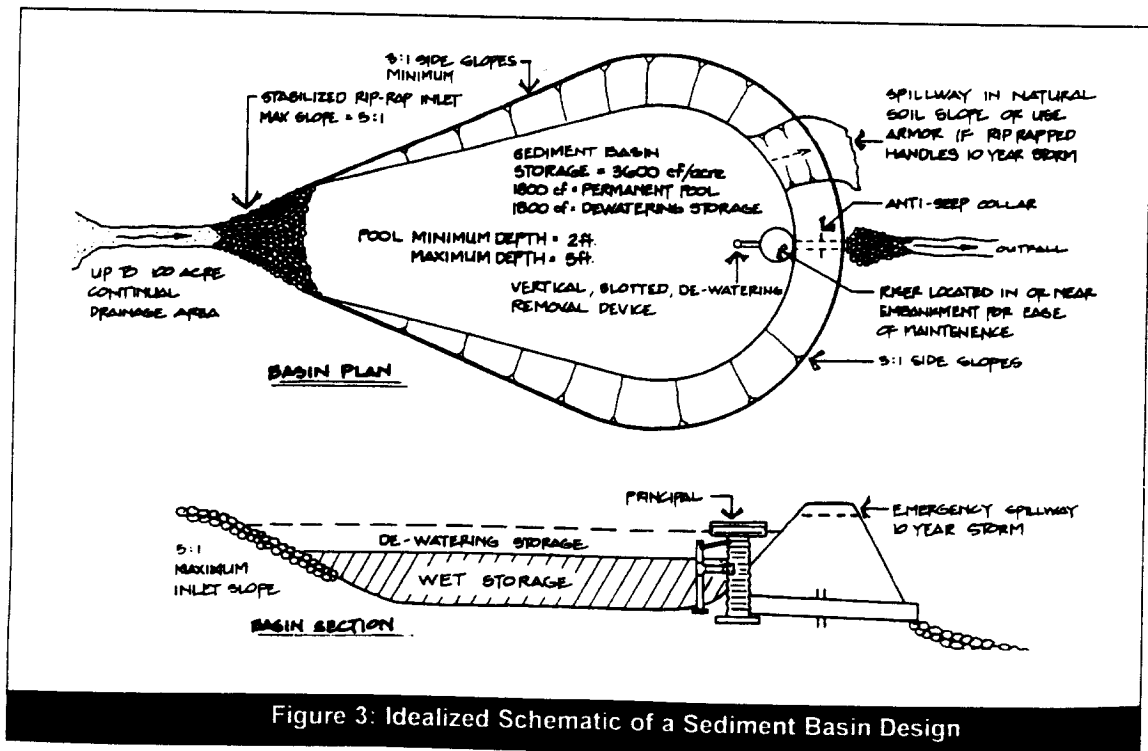

Figure 3: Idealized Schematic of a Sediment Basin Design



preventing erosion from occurring in the first place. Hydroseeding, straw/mulching, slope stabilization and construction sequencing all played a major role in reducing the concentration of sediment delivered to downstream trap or basin.

The study also recommended a series of design improvements for sediment basins. Most notably, the study recommended that storage capacity in basins should be increased from the current 1,800 cubic feet/acre to 3,600 cubic feet/acre. Half of the total storage capacity should be wet, and the remaining half dry (Figure 3). The dry storage is regulated by a vertical dewatering device that extends from the riser. The device can be protected by large mesh hardware cloth. Filter fabric should be avoided as the fine silts and clays quickly clog pore spaces in the fabric. This design should be capable of entirely containing sediment-laden runoff from small storms, and allowing two to six hours of extra detention for the larger storm events as well.

These improvements should increase sediment removal when its needed most: during larger storms that occur in the later stages of construction.

—TRS

#### References

Schueler, T. and J. Lugbill. 1990. *Performance of Current Sediment Control Measures at Maryland Construction Sites*. Occoquan Watershed Monitoring Lab and Metropolitan Washington Council of Governments. Washington, DC. 90 pp.

# Construction Practices: The Good, the Bad, and the Ugly

by Robert G. Paterson, Assistant Professor, University of Texas

**O**ver the last two decades, numerous field and laboratory studies have tested the best techniques for preventing erosion and trapping suspended sediment at construction sites. The U.S. EPA has incorporated many of these findings into its guidance documents for the NPDES stormwater and nonpoint source control programs (U.S. EPA, 1992; 1993). However, very few of the studies have assessed how well these plans are actually implemented at construction sites.

Anecdotal evidence suggests that poor installation and maintenance of construction practices is endemic in many state and local erosion and sediment control (ESC) programs (Banach, 1988; Dawson, 1988; Doenges *et al.*, 1990; Lemonde, 1988). Detailed information, however, is lacking on the specific problems encountered during implementation (Dawson, 1988; Doenges *et al.*, 1990). Systematic analysis of ESC program implementation is needed to advance these practices. Designers need to know which construction practices are most problematic and know how to limit performance failures through better design and inspection.

Sediment control inspectors can also benefit from this kind of information. For example, many inspectors learn job skills through an apprenticeship process which unfortunately relegates much learning to trial and error despite the best efforts of senior ESC professionals to help them "learn the ropes." In other cases, problems are encountered on such a piecemeal basis that trends cannot be easily discerned.

This article sheds light on implementation problems that persist among many commonly prescribed construction practices based on a comprehensive evaluation of North Carolina's ESC Program undertaken in 1990. Problems with construction practices were identified through both expert opinion surveys and an investigation of over 1,000 prescribed construction practices in the field. Expert opinions were obtained through a mail survey of 44 North Carolina ESC administrators using the Total Survey Design method. Responses were received from 77% of the total population.

Expert opinion was sought on two key implementation issues. First, administrators were asked to rate a list of commonly used construction practices on a subjective five-point effectiveness scale (excellent, good, average, fair, and poor) based on their typical field

experiences. Second, the administrators were also asked to comment on their perception of the main cause(s) of failures for each construction practice. Possible reasons for failures included that the practice was installed poorly, did not work, or was poorly maintained.

The field investigation provided an independent assessment of ESC implementation for more than 1,000 construction practices evaluated in a total of 128 ESC plans within nine North Carolina jurisdictions. The nine jurisdictions were selected to adequately represent construction sites in each of North Carolina's three physiographic regions (mountain, piedmont and coastal plain) and across three different levels of program administration (i.e., municipal, county and state administered programs).

Project sites were randomly selected from a list of active construction projects within each jurisdiction using a random assignment procedure. The selection procedure provided a fairly even mix of development types: 56% of the construction projects were residential and 44% were non-residential. The quality of ESC implementation was evaluated in terms of (a) whether the practices had been adequately installed and (b) if they were adequately maintained.

## Study Results

### *Expert Opinion on ESC Practice Performance*

Few North Carolina ESC administrators were satisfied with the typical field performance of most construction practices; only three out of the 11 construction practices were considered to be good or excellent (Figure 1). Sediment basins, sediment traps, and riprap stabilized channels received the highest percentage of favorable ratings. The worst performers, by a large margin, were brush barriers and straw bales. Only two out of 34 administrators rated typical field performance as "good" and none viewed typical brush barrier performance as satisfactory. Evaluations also tended to be negative on pre-fabricated silt fence and filter strip performance. Opinion was more varied on the adequacy of vegetatively stabilized channels, slope drains, constructed silt fence, and storm drain inlet protection (SDIP) measures.

A majority of the experts attributed construction practice failure to poor installation (Table 1). Most administrators identified poor installation as the primary cause of failure for filter strips, pre-fabricated silt



fence, constructed silt fence, slope drains, vegetatively stabilized channels, and riprap lined channel. In many cases, however, poor maintenance ran a close second as the primary cause of likely failure. Most administrators identified poor maintenance as the principal cause of failures for sediment basins, sediment traps, and storm drain inlet protection measures.

Again, the most technically questionable construction practices were thought to be brush barriers and straw bales. Table 2 summarizes typical comments from administrators from the open response option on the survey.

#### Field Survey Performance Ratings

The field survey corroborated much of the expert opinion. For example, it appears that few plan reviewers are allowing the use of questionable practices. For example, only two of the 128 sediment control plans evaluated prescribed the use of straw bale or brush barriers. Likewise, pre-fabricated silt fence, filter strips, and slope drains were used sparingly.

Perhaps the most interesting finding was the number of construction practices that were never installed even though they were shown on the plan. More than

**Table 1: Main Reason for Construction Practice Failure as Identified by North Carolina Administrators (Reported in Percentage Response), N = 22-29**

Erosion and sediment control measure	Technically deficient (%)	Poor installation (%)	Poor maintenance (%)
Brush barriers	58	29	13
Straw bales	64	20	16
Filter strip	23	41	36
Pre-fabricated silt fence	23	54	23
Silt fence	7	57	36
Sediment trap	0	38	62
Sediment basin	11	29	60
Inlet protection	16	40	44
Slope drain	0	76	24
Vegetated channel	27	57	15
Riprap channel	15	74	11

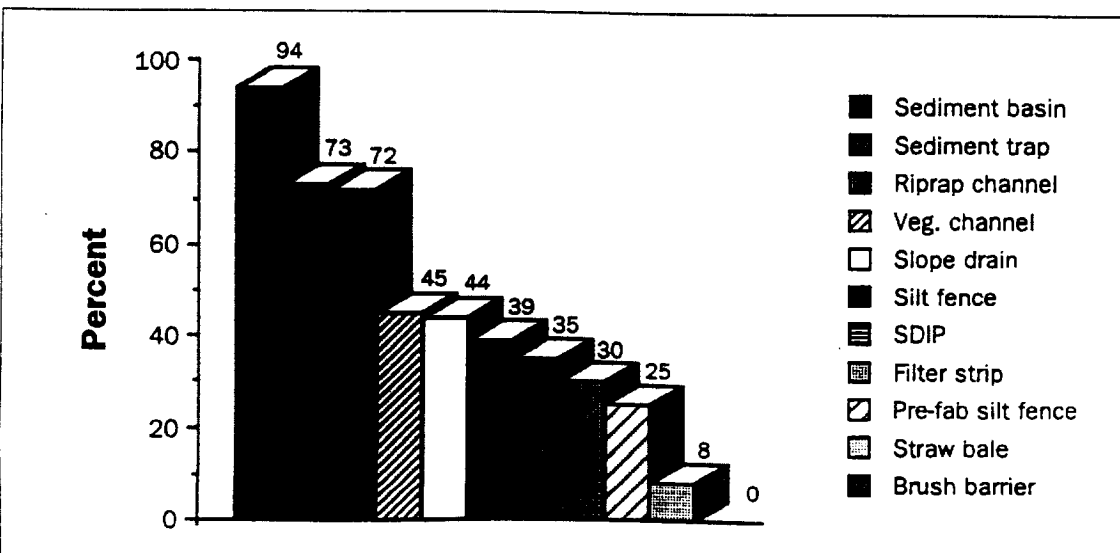

**Figure 1: Administrators' Performance Ratings—Percent Indicating Satisfactory Performance**

R0079800

7

a quarter of the two most commonly prescribed construction practices (storm drain inlet protection and silt fence) were never installed and nearly half of all prescribed velocity dissipators were not in place.

The two most favored practices, SDIP and silt fences, were frequently installed in a poor manner. Among those SDIP measures actually installed, about a third were not properly constructed (construction lacked required materials like reinforcing wire and adequate coverage of the base with filtration material); 29% were not properly anchored (primarily silt fence designs); and nearly half needed additional maintenance if they were to perform properly (problems included torn filter fabric, damage from vehicular impact and sediment build-up). Because of those failures, evaluators noted visible sediment entering into drainage systems in about one out of every five storm drain inlet protection measures installed.

More than 40% of silt fence applications were poorly installed and two-thirds required maintenance to perform properly. The most common installation problems included failure to use reinforcing wire (42%), failure to anchor filter fabric (33%), and failure to appropriately space posts or install the full length of required fencing (22%). The most common maintenance problems were failure to repair damaged fencing (whether

knocked down by construction vehicles, hydraulic overload, or silt build-up) and damaged filter fabric (also possibly due to construction activities or natural deterioration).

The final column in Table 3 corroborates much of the anecdotal evidence that poor maintenance remains a persistent impediment to effective sediment control. With only three exceptions, more than one out of every four ESC practices were considered to be functionally impaired because of poor maintenance. Once again, the two most commonly used construction practices were among the top five offenders. And, while most sediment basins and traps were installed correctly, nearly one-half of the traps and one-fourth of the basins were reported to fail because of poor maintenance.

Finally, the field survey examined several construction practices that were not evaluated in the expert opinion surveys, including anti-tracking pads, filter berms and dikes. For example, while anti-tracking pads are widely recognized as an important part of erosion control plans, almost half of the plans failed to require them (and of those installed, almost a third needed maintenance). Second, the field survey revealed that silt fence has generally replaced earthen dikes as the diversion measure of choice at most construction sites. The widespread use of silt fence perhaps should be re-evaluated in light of their dismal performance in the field, compared to surprisingly strong performance of dikes.

Table 2: Comments on Why Construction Practices Fail

Stormwater Management Practice	Comments
Straw bales and brush barriers	Rapid loss of filtration capacity due to deterioration and gaps often left between measure and ground.
SDIP and silt fence	Failure to install all parts of the measure (e.g., reinforcing wire), failure to anchor the base, failure to cover entire designated area with fence, and construction vehicles back over devices.
Filter strips	Undersized filter area, sparse vegetation, and concentrated runoff at entry.
Vegetative and riprap channels	Inadequate channel bed construction and attempted vegetative stabilization in high velocity flow.
Slope drains	Failure to anchor drain to slope, failure to make inlet water tight, failure to install velocity dissipater at outlet, and failure to leave inlet clear of debris and sediment build up.
Sediment basins and traps	Failure to remove built up sediment, failure to stabilize embankments, spillway deterioration, improper levelling of embankments, failure to anchor riser pipe, failure to install trash rack.

### The Good, the Bad, and the Ugly

What lessons can be drawn from the above analysis? Well the good news, at least in North Carolina, is that plan reviewers and inspectors are reducing field performance problems by minimizing the use of construction practices with a chronic history of poor implementation (i.e., the low use of straw bales, brush barriers, pre-fabricated silt fence, and filter strips). The bad news is that the study has corroborated prior anecdotal evidence that poor implementation remains a widespread obstacle to effective sediment pollution control. The worst news is that these results came from an investigation of a program that many consider to be one of the strongest ESC programs in the nation. This suggests that ESC programs may perform even worse in states that rely solely on voluntary compliance.

The study raised many more questions than it answered. For example, it provided little insight regarding underlying causes of the installation and maintenance failures noted. Certainly one could take the easy route and blame all implementation problems on developers and their grading contractors since they are arguably responsible for ensuring that construction practices outlined in their sediment control plans are installed correctly. However, such an antagonistic ap-

Table 3: North Carolina Field Survey of the Performance of Construction Practices

Erosion and sediment control measures	No. of construction practices required in plan	Percent actually installed	Percent installed correctly	Percent adequately maintained
Storm drain inlet protection	189	71 *	72 *	55 *
Silt fence	174	67 *	58 *	34 *
Sediment trap	155	86	86	58 *
Veg./earth channel	147	77	98	87
Velocity dissipaters	147	51 *	86	69 *
Anti-tracking pad	66	89	89	67 *
Sediment basin	43	84	94	75 *
Filter berm	25	52 *	85	54 *
Earthen dike	25	92	100	92
Riprap channel	20	50 *	90	50 *
Check dam	20	80	94	63 *
Pipe slope drain	9 **	89	100	50
Filter strip	4 **	100	100	100
Straw bale	2 **	100	50	0
Brush barrier	1 **	100	0	0
Prefab silt fence	1 **	100	100	100

\* 25% or more of practices rated inadequate for listed criterion

\*\* Inadequate number of cases for analysis

proach undoubtedly oversimplifies what in many cases is likely to be a complex situation.

Consider, for example, the silt fence installation and maintenance problems identified by the field survey. The cynic might conclude that the problem is simply one of developers saving a buck. And, while some installation problems are surely due to this motive, a lack of training may also be responsible. In several instances, it was clear that the grading contractor had incurred all material and labor installation costs, but the construction crew lacked the proper training to properly anchor the fence. In other instances, contractors constructed the silt fencing to plan specifications, but placed them in locations where they served little practical purpose. This problem often occurred when erosion control plans contained vague field information, such as notes that merely specify, "Silt fence to be placed where necessary."

Likewise, while many maintenance problems are the result of neglect, in many other instances, problems result from design problems such as hydraulic overload or inappropriate fence placement (e.g., where vehicles are likely to damage the devices or leave inadequate room for maintenance). The point of this discussion is not to shift blame, but rather to emphasize that installation and maintenance problems often may be more complex than they initially appear. Implementation problems may stem not only from a lack of commitment, but also from a lack of knowledge on *how* to comply (e.g., poor training, poor plans, and site-specific constraints).

Given the critical importance of field implementation of ESC programs and the apparent shortcomings that exist, much more attention should be focused on improving plan implementation. The task for researchers and environmental professionals alike is to identify the principal causes of construction practice failures and



R0079802

test corrective design, technical assistance, and enforcement responses so that a better foundation for effective program implementation can be undertaken.

#### References

- Banach, M. 1988. "Implementation of Sediment and Erosion Control Programs in Connecticut," in K. Stuart and J. Haracz (eds), *Soil and Water Management: Planning for Site Development, Proceedings of a Symposium on Erosion and Sediment Control and Stormwater Management*. Southern New England Chapter of the Soil and Water Conservation Society: Storrs, CT.
- Dawson, A.D. 1988. "Role of Volunteer Boards in Environmental Regulation: Pitfalls and Promises," in K. Stuart and J. Haracz (eds), *Soil and Water Management: Planning for Site Development, Proceedings of a Symposium on Erosion and Sediment Control and Stormwater Management*. Southern New England Chapter of the Soil and Water Conservation Society: Storrs, CT.
- Doenges, J.M., C.P. Allan, R.J. Jontos, and C.A. Liebler. 1990. *Carrying Capacity of Public Water Supply Watersheds: A Literature Review of Impacts on Water Quality From Residential Development*. Hartford, CT: Connecticut Department of Environmental Protection.
- Lemonde, A.O. 1988. "Installation and Maintenance of Stormwater Management Basins," in K. Stuart and J. Haracz (eds), *Soil and Water Management: Planning for Site Development, Proceedings of a Symposium on Erosion and Sediment Control and Stormwater Management*. Southern New England Chapter of the Soil and Water Conservation Society: Storrs, CT.
- Malcolm, H.R., A.C. Beard, R.J. Burby, E.J. Kaiser, M.I. Luger, and R.G. Paterson, 1990. *Evaluation of the North Carolina Erosion and Sediment Control Program*. Raleigh, NC: Land Quality Section, Division of Land Resources, North Carolina Department of Environment Health and Natural Resources.
- United States, Environmental Protection Agency, Office of Water. 1993. *Guidance Specifying Management Measures For Sources of Nonpoint Pollution in Coastal Waters*. (840-B-92-002) January.
- United States, Environmental Protection Agency, Office of Water. 1992. *Storm Water Management for Construction Activities, Developing Pollution Prevention Plans and Best Management Practices*. (EPA 832-R-92-005) September.

## Article 61

Technical Note #85 from *Watershed Protection Techniques*, 2(3): 440-442

# Delaware Program Improves Construction Site Inspection

**E**rosion and Sediment Control (ESC) practices require vigilance and frequent maintenance. Unfortunately, most ESC programs do not have the resources to effectively inspect construction activity. Responses from the Center's survey of 80 ESC programs indicate that each field inspector is responsible for an average of at least 150 sites per year. At this rate, inspectors are overburdened even if all the sites are not under active construction at the same time. If sediment controls are only 60 to 70% effective under good conditions, how can we expect to protect streams without sufficient staff to ensure that ESC practices are applied properly?

One solution to this problem is to place part of the burden for inspection on the development community. A program in Delaware requires some developers to hire their own inspectors (Shaver and Piorko, 1996). Although these inspectors are officially called the construction reviewers, they are referred to as "private inspectors" in this article to avoid confusion with plan reviewers. The article describes when private inspectors are required, responsibilities under this program, other programs that can supplement it and some important safeguards. Finally, it provides some guidelines on developing a similar program.

Table 1: Sites Required to Hire a Private Inspector

- All sites with greater than 50 acres of disturbed area
- Any site, as determined by the resource agency
- Sites under construction that present significant management problems

Table 2: Responsibilities Under the Private Inspector Program

### *Inspector Responsibility*

- Certification and periodic re-certification (passing a training course)
- Making weekly inspection reports to the contractors and inspection agency
- On-site technical advice for contractors

### *Professional Engineer Responsibility*

- Oversight and technical advice to the Private Inspector
- Usually works at the same firm as the Private Inspector

### *ESC Agency*

- Training for Private Inspectors
- Review of all inspection reports
- "Spot checks" on construction sites
- Enforcement action

### *Contractor/Developer Responsibility*

- ESC maintenance and installation
- Hiring and paying for inspectors
- Feedback on site conditions, problems

7

R0079804

### Who Has to Hire a Private Inspector?

Private inspectors are required for sites that the state or local ESC agency anticipates will require intense agency resources to complete site inspection (Table 1). Because each construction project is different, the need for a private inspector is decided on an individual basis.

### Responsibilities

Private inspectors, government agencies and contractors/developers all have some responsibility to ensure that erosion and sediment control plans are effectively implemented. Private inspectors are required to become certified and periodically re-certified by passing a standardized course. Once licensed, they act as the "eyes" on construction sites. They make at least weekly site visits and report both violations and inadequacies in the plan to the developer, contractor and ESC agency. The inspector also provides on-site technical assistance to the contractor when needed.

Although the goal of this program is to ease the burden on public sector employees, they still play an important role. Private inspectors are licensed through the state program of the Department of Natural Resources and Environmental Control (DNREC). The state offers a 32-hour course every year that covers both stormwater management and ESC. In addition, government inspectors review reports submitted by private inspectors, and conduct spot checks for accuracy. Finally, fines or other penalties are issued through government agencies.

Developer and contractor are ultimately responsible for the implementation of effective erosion and

sediment controls on construction sites. They must correct violations within a specific time period. An additional responsibility under this program is hiring a private inspector. Consequently, they have some input selecting the person that they will deal with on a regular basis.

### Supporting Programs

Because developers and contractors have a great deal of responsibility, their training is important. Under Delaware's "Blue Card" program, one contractor from each site is required to attend a training course (Table 3). This program provides a strong backdrop to supplement the private inspector program. In addition, it applies to all sites-not only the larger or more complicated sites covered in the private inspector program. Training for both designing professionals and public employees is also crucial to developing effective ESC plans.

### Safeguards

One of the major concerns at the inception of the Delaware program was that private inspectors would not report violations because they are employed by developers. There are two provisions to protect against collusion in this program. First, if the spot checks conducted by the ESC agency show that the private inspector did not report violations, his license can be revoked or suspended. Second, the private inspector must be supervised by a Professional Engineer, whose P.E. license can be suspended for ethical breaches.

Table 3: Delaware's "Blue Card" Contractor Program

- One contractor on each construction project needs to be certified
- The contractor attends a 3.5 hour course offered by DNREC
- This person is responsible for ESC techniques and on-the-job training of other contractors

Table 4: Steps to Implementing a Private Inspector Program

- Assign full-time staff to administer the program
- Decide on criteria for use of private inspectors
- Develop a training program and certification process
- Incorporate Professional Engineer oversight
- Define specific site spot checking schedule
- Include recourse for fraudulent inspection reports
- Carry out enforcement action for contractors who violate plans
- Pilot in a test area
- monitor using objective criteria to evaluate the program
- Revise the program periodically based on past performance

R0079805



## Results

Delaware's private inspector program began fairly recently (1991), so it is difficult to quantify its success. One measure, however, is the degree of response to training courses. As of February 1997, 340 people have been certified. In addition, there is a qualitative opinion that the "best sites" are those that use private inspectors (Shaver, 1996). A more formal analysis is just beginning.

## How to Start a Private Inspector Program

Developing a private inspector program is time consuming and must be done carefully. Some steps to implementing a successful program are described in Table 3. While Delaware's program seems to have been successful, using it as a "cookie cutter" approach may not be appropriate. Some of the details, such as what sites should be included, may vary between states. Thus, piloting in test areas and continuous reevaluation are recommended. Although

program development is a major undertaking, results in Delaware's suggest that the effort may pay off in the long run.

—TRS

## References

- Shaver, H.E., 1996. Personal Communication. Delaware Department of Natural Resources and Environmental Control. Dover, DE.
- Shaver, H.E. and F.M. Piorko. 1996. "A Certification Program for sediment and Stormwater Inspectors: A Private Supplement to Public Inspection." In: *Assessing the Cumulative Impact of Watershed Development on Aquatic Ecosystems and water Quality, A National Symposium*. US Environmental Protection Agency (EPA Region 5) with the Northeastern Illinois Planning Commission. Chicago, IL.

# Enforcing Sediment Regulations in North Carolina

by Robert G. Paterson, Assistant Professor, University of Texas at Austin

One of the most glaring deficiencies in the watershed protection literature today is the lack of research on the behavioral elements that must be met to improve outcomes (Andrews, 1992; Geller, 1989). While the ultimate goal of our environmental regulation is to eliminate or reduce behavior that degrades the environment, very little research has focused on identifying the most effective ways to accomplish that end. In an ideal situation, watershed managers would (1) know all the key cause-and-effect relationships between various program interventions and target group responses, (2) know the frequency, intensity and combination of intervention strategies necessary to evoke long-term behavioral change, and (3) be able to select the most cost-effective interventions among available alternatives. Unfortunately, in virtually all areas of watershed management, our knowledge is far from this level of understanding.

Researchers in North Carolina sought to answer some of those questions within the context of urban erosion and sediment control (ESC) programs. The researchers tested hypotheses about the impact of various enforcement activities to improve compliance in a sample of 128 construction sites drawn randomly from the list of active projects in nine case study jurisdictions. Each site was evaluated for compliance with the approved ESC plan (i.e., the percentage of control measures installed and maintained as required) and the program's overall objective of preventing significant off-site sediment losses (Malcom *et al.*, 1990; Paterson, 1993). Four key enforcement characteristics that emerged were significant predictors of compliance: expertise, comprehension, cooperation and vigilance were identified.

## Expertise

Two measures of enforcement expertise were statistically significant predictors of compliance—professional design oversight and the sediment control inspector's experience. For example, maintenance compliance was about 15% better at projects that required professional design oversight (e.g., an engineer or landscape architect) as compared to those that did not. Professional design oversight was also a statistically significant predictor of the likelihood of performance compliance at sites. This is consistent with study expectations since requiring professional design oversight

at a project creates an in-house, on-site enforcement agent with the necessary expertise to solve problems. Furthermore, the engineer or other qualified professional ensures that commitment to ESC is sustained throughout the life of the project.

Better compliance was achieved on sites that were monitored by more seasoned ESC inspectors. This is consistent with expectations given that most inspectors are trained through an apprenticeship process rather than meeting any formal degree or certification requirements.

## Comprehension

Efforts to ensure that all the key development personnel understand ESC plan requirements also had a significant payoff in field performance. For example, pre-construction conferences were found to be instrumental in ensuring that control measures are installed and maintained and that the overall program objectives are achieved (see Lemonde, 1987; Thompson, 1984). Pre-construction conferences lead to a 15% better maintenance compliance rate compared to sites where no meeting was held. Similarly, the study found that clear plans with a minimum of clutter, simple maintenance requirements, and precise directions on installation also contributed significantly to better compliance.

## Cooperation

While there has been much debate over the merits of pursuing a legalistic—coercive as opposed to cooperative—bargaining approach to regulatory enforcement, there have been few attempts to empirically test which strategy provides a superior outcome (Sigler and Murphy, 1991; Bardach and Kagan, 1982). Using behavioral research methods to determine inspectors' general enforcement philosophy, the study found that the probability of project compliance was enhanced at sites where inspectors adhered to a more cooperative bargaining approach. As the term implies, a cooperative-bargaining enforcement approach tends to involve high levels of interpersonal communication and emphasizes a problem-solving approach to enforcement that only shifts to a stricter enforcement when faced with recalcitrant offenders. This finding is consistent with the study hypothesis which built on case study observations from the regulatory enforce-

ment literature (Bardach and Kagan, 1982) and empirical observations from the applied behaviorist and social psychology literature (see e.g., Cialdini, 1989; Geller, 1989).

### Vigilance

Finally, the study provides empirical support for the importance of inspection vigilance. Both the frequency and duration of project inspections were positively associated with the level of installation and maintenance compliance at a site. Surveillance keeps regulatory compliance a high priority at the site and provides opportunities for inspectors to build problem-solving skills among site personnel.

### Conclusion

In summary, the study findings supported many of the theoretical assertions made by Bardach and Kagan (1982) in their seminal work on regulatory enforcement as to what would constitute an effective inspectorate—a good inspector is technically competent, aims to win cooperation, educates the regulated, serves a diagnostic as well as an enforcement role, communicates effectively about substantive issues, wins respect for fairness and uses an explicit problem-solving orientation. The good inspector finds additional eyes and ears in the regulated organization by gaining respect and commitment among the key implementing personnel.

### References

- Andrews, R. 1992. "Heading Off Potential Problems." *EPA Journal*, 18(2)41-45.
- Bardach, E. and R. Kagan. 1982. *Going By the Book: The Problems of Regulatory Unreasonableness*. Philadelphia: Temple Univ. Press.
- Cialdini, R.B. 1989. "Social Motivations to Comply: Norms, Values, and Principles." in J.A. Roth and J.T. Scholz (eds), *Taxpayer Compliance: Social Science Perspectives*. Philadelphia: University of Pennsylvania Press.

Geller, E.S. 1989. "Applied Behavioral Analysis and Social Marketing: An Integration for Environmental Preservation." *Journal of Social Issues*, 45(1) 17-36.

Lemondé, A. 1987. "Installation and Maintenance of Stormwater Management Basins." in *Proceedings of Soil and Water Management Conference*. Southern New England Chapter, Soil Conservation Society of America.

Malcom, H.R., A.C. Beard, R.J. Burby, E.J. Kaiser, M.I. Luger, and R.G. Paterson. 1990. *Evaluation of the North Carolina Erosion and Sediment Control Program*. Raleigh, NC: Land Quality Section, Division of Land Resources, North Carolina Department of Environment Health and Natural Resources.

Paterson, R.G. 1993. *Capacity and Commitment: The Keys to Environmental Regulatory Compliance*. Doctoral Dissertation University of North Carolina at Chapel Hill.

Sigler J.A. and J.E. Murphy, 1991. "A Novel Approach to Business-Government Relationships." in J.A. Sigler and J.E. Murphy (eds), *Corporate Law-breaking and Interactive Compliance*. New York: Quorum Books.

Thompson, D. 1984. "Erosion and Sediment Control on Construction Sites." in *Proceedings of a Seminar on Sedimentation and Erosion Control*. Land Tech Consultants and CT Association of Soil and Water Conservation Districts, Storrs, CT.



R0079808

7

R0079809

# Section 8: Stormwater Treatment

## Watershed Protection Tool #6

The basic objective of stormwater treatment is to compensate for the hydrological changes caused by watershed development and, more specifically, impervious cover. A watershed manager looks to stormwater treatment to solve many different problems caused by runoff. Thus, a series of practices is employed to maintain groundwater recharge and purity, reduce stormwater pollutant loads, protect stream channels from eroding, prevent increased overbank flooding and safely convey dangerous floods. Generally, stormwater treatment practices are engineered to capture, store, treat or infiltrate the increased volume of stormwater runoff produced by new development using structural practices and non-structural practices.

The most common stormwater treatment practices are stormwater ponds, wetlands, filtering systems, infiltration practices and open channels. Watershed managers need to carefully choose which stormwater treatment practices are most appropriate for a given watershed, balancing their differing capabilities to remove pollutants, recharge groundwater and detain floods. At the same time, they must realistically assess how long they will last, their maintenance track record, and their impact on both the downstream environment and the local community.

The 62 articles that follow provide a detailed summary of the current state of stormwater treatment practices. The articles are organized into seven parts: an initial part that contains general articles on stormwater treatment, followed by more specific research on each of the major stormwater treatment practices: ponds, wetlands, infiltration, filters, open channels and the ubiquitous "other" category.

### *Trends in Stormwater Treatment in the Last Decade*

As recently as 10 years ago, most communities were primarily concerned about flood control, and as a consequence only sought to manage the quantity of stormwater generated from a development site. New research and federal regulations, however, prompted many communities to become more concerned with the quality of stormwater, and now pollutant removal is a fairly common goal at the local level. This new era has spawned an enormous number of new practices and designs, many of which have been tested in the field. More than a hundred research studies have been conducted in the last decade that demonstrate both the capabilities and limitations of various stormwater treatment practices. As a consequence, the design and implementation of stormwater treatment practices have become more standardized, although the sorting out process is not yet complete. But at least from the standpoint of stormwater quality, watershed managers have enough comparative information to make better choices about which stormwater treatment practices to apply to protect their watershed.



At the same time, however, researchers have found that the current generation of stormwater treatment practices can neither protect downstream channels from erosion nor recharge groundwater. A steady stream of research reports indicate that these deficiencies are responsible for much of the physical and habitat impairment of urban streams (see Section 2). As a result, the objectives for stormwater treatment have expanded yet again to confront the channel enlargement and recharge problems. At the close of the decade, several states and localities had adopted engineering criteria to address these problems.

"A watershed manager looks to stormwater treatment to solve many different problems caused by runoff."

Two other key trends emerged toward the end of the 90s. The first was a shift toward watershed-based stormwater criteria, which departed from the site-based stormwater criteria that had been uniformly applied to sites in the past. Instead, designers were given more specific recommendations on how to size, select, design and locate stormwater practices in order to meet specific watershed objectives. The shift to watershed-based stormwater treatment, in turn, has created new and higher expectations for the performance of stormwater practices. Success is no longer measured solely by the quality of runoff that leaves the site, but rather by the quality of the stream to which it drains.

The second key trend was a greater recognition of the critical role that better site design could play in stormwater treatment. Quite simply, better site design makes the stormwater engineer's job much easier, by reducing impervious cover, providing more sensible options for locating practices, and by assigning stormwater treatment an earlier and more prominent role in the design of commercial and residential development.

#### *Stormwater Treatment Research Needs*

Several lines of research are needed to support the practice of stormwater treatment. First, more research is needed on stormwater practices such as bioretention and dry swales that have only come into wide use in the last few years. Some older practices that have fallen out of favor may also merit a fresh look. In particular, a wide variety of permeable pavers, pavements, bricks, and concrete have recently come onto the market, some of which could fulfill the age-old dream of making impervious areas behave as if they are not. While our past experience with these products has been disappointing, we should not abandon the ultimate goal of no net runoff for our parking lots, rooftops and roads.

Second, more intensive monitoring and modeling are needed to determine the range of storms that cause channel enlargement and the detention times needed to prevent it. Given the impact of channel enlargement on urban streams, we cannot afford to fly by the seat of our pants anymore.

Lastly, we need to continue and expand our testing of stormwater practices at the watershed level. As noted earlier, the true measure of success for stormwater treatment is the quality of the stream and not merely the runoff. While initial watershed-scale testing has not yet indicated that stormwater treatment makes a statistical difference in the habitat or biological diversity score of a stream, we have yet to test the newest generation of practices or sizing criteria that incorporate our expanded objectives for stormwater treatment.

## Stormwater Treatment Practices Contents

63.	Why Stormwater Matters .....	365
64.	Comparative Pollutant Removal Capability of Stormwater Treatment Practices .....	371
65.	Irreducible Pollutant Concentrations Discharged From Stormwater Practices .....	377
66.	Stormwater Strategies for Arid and Semiarid Watersheds .....	381
67.	Microbes and Urban Watersheds: Ways to Kill 'Em .....	392
68.	The Economics of Stormwater Treatment: An Update .....	401
69.	Trends in Managing Stormwater Utilities .....	406

#### *Ponds*

70.	Pond/Wetland System Proves Effective in New Zealand .....	411
71.	Performance of Stormwater Ponds and Wetlands in Winter .....	413
72.	Performance of a Stormwater Pond/Wetland System in Colorado .....	418
73.	Performance of Two Wet Ponds in the Piedmont of North Carolina .....	420
74.	Performance of Stormwater Ponds in Central Texas .....	422
75.	Pollutant Removal Dynamics of Three Canadian Wet Ponds .....	426
76.	A Tale of Two Regional Wet Extended Detention Ponds .....	433
77.	Performance of a Dry Extended Pond in North Carolina .....	437
78.	Influence of Groundwater on Performance of Stormwater Ponds in Florida .....	439

79.	The Environmental Impact of Stormwater Ponds .....	443
80.	Pollutant Dynamics of Pond Muck .....	453
81.	The Pond Premium .....	461
82.	Water Reuse Ponds Developed in Florida .....	463
83.	Trace Metal Bio-accumulation in the Aquatic Community of Stormwater Ponds .....	464
84.	Human and Amphibian Preferences for Dry and Wet Stormwater Pond Habitat .....	466
85.	Dragonfly Naiads as an Indicator of Pond Water Quality .....	468
86.	Establishing Wildflower Meadows in New Jersey Detention Basins .....	471
87.	Persistence of Wetland Plantings Along the Aquatic Bench of Stormwater Ponds .....	472

#### *Wetlands*

88.	Return to Lake McCarrons .....	475
89.	Nutrient Dynamics and Plant Diversity in Stormwater Wetlands .....	479
90.	Adequate Treatment Volume Critical in Virginia Stormwater Wetland .....	480
91.	Pollutant Removal by Constructed Wetlands in an Illinois River Floodplain .....	482
92.	Pollutant Dynamics Within Stormwater Wetlands: I. Plant Uptake .....	485
93.	Pollutant Dynamics Within Stormwater Wetlands: II. Organic Matter .....	488
94.	Pollutant Removal Capability of a "Pocket" Wetland .....	491
95.	Performance of Gravel-based Wetland in a Cold, High Altitude Climate .....	493
96.	The StormTreat System: A New Stormwater Runoff Treatment .....	495
97.	Vegetated Rock Filters Used to Treat Stormwater Pollutants in Florida .....	498
98.	Practical Tips for Establishing Freshwater Wetlands .....	500
99.	Broad-leaf Arrowhead: A Workhorse of the Wetlands .....	502
100.	Mosquitos in Constructed Wetlands: A Management Bugaboo? .....	503

#### *Infiltration*

101.	Failure Rates of Infiltration Practices Assessed in Maryland .....	511
102.	Longevity of Infiltration Basins Assessed in Puget Sound .....	513
103.	A Second Look at Porous Pavement/Underground Recharge .....	515
104.	The Risk of Groundwater Contamination from Infiltration of Stormwater .....	518

#### *Filters*

105.	Developments in Sand Filter Technology to Treat Stormwater Runoff .....	523
106.	Further Developments in Sand Filter Technology .....	531
107.	Performance of Delaware Sand Filter Assessed .....	540
108.	Field Evaluation of a Stormwater Sand Filter .....	543
109.	Innovative Leaf Compost System Used to Filter Runoff in Northwest .....	546
110.	Bioretention as a Stormwater Treatment Practice .....	548
111.	Multi-Chamber Treatment Train Developed for Stormwater Hot Spots .....	551

#### *Open Channels and Swales*

112.	Performance of Biofilters in the Pacific Northwest .....	559
113.	Runoff and Groundwater Dynamics of Two Swales in Florida .....	562
114.	Performance of Grassed Swales Along East Coast Highways .....	564
115.	Pollutant Removal Pathways in Florida Swales .....	566
116.	Ditches or Biological Filters? Classifying Pollutant Removal in Open Channels .....	569
117.	Performance of Dry and Wet Biofilters Investigated in Seattle .....	573
118.	Level Spreader/Filter Strip System Assessed in Virginia .....	577

**R0079812**

---

*Other*

119. Performance of Oil/Grit Separators in Removing Pollutants at Small Sites ..... 581  
120. Performance of a Proprietary Stormwater Treatment Device: The Stormceptor ..... 584  
121. New Developments in Street Sweeper Technology ..... 588  
122. The Value of More Frequent Cleanouts of Storm Drain Inlets ..... 592

R0079813



# General Background

R0079814

8



# Why Stormwater Matters

Urban development has a profound influence on the quality of local streams. To start, development dramatically alters the local hydrologic cycle (see Figure 1). The hydrology of a site changes during the initial clearing and grading that occur during construction. Trees that had intercepted rainfall are removed, and natural depressions that had temporarily ponded water are graded to a uniform slope. The spongy humus layer of the forest floor that had absorbed rainfall is scraped off, eroded or severely compacted. Having lost its natural storage capacity, a cleared and graded site can no longer prevent rainfall from being rapidly converted into stormwater runoff.

The situation worsens after construction. Roof tops, roads, parking lots, driveways and other impervious surfaces no longer allow rainfall to soak into the ground. Consequently, most rainfall is directly converted into stormwater runoff. This phenomenon is illustrated in Figure 2, which shows the increase in the volumetric runoff coefficient ( $R_v$ ) as a function of site imperviousness. The runoff coefficient expresses the fraction of rainfall volume that is converted into stormwater runoff. As can be seen, the volume of stormwater runoff increases sharply with impervious cover. For example, a one acre parking lot can produce 16 times more stormwater runoff than a one acre meadow each year.

The increase in stormwater runoff can be too much for the existing drainage system to handle. As a result, the drainage system is often "improved" to rapidly collect runoff and quickly convey it away (using curb and gutter, enclosed storm sewers, and lined channels). The stormwater runoff is subsequently discharged to downstream waters, such as streams, reservoirs, lakes or estuaries.

### Declining Water Quality

Impervious surfaces accumulate pollutants deposited from the atmosphere, leaked from vehicles, or wind-blown in from adjacent areas. During storm events, these pollutants quickly wash off, and are rapidly delivered to downstream waters. Some common pollutants found in urban stormwater runoff are profiled in Table 1 and include the following:

*Nutrients.* Urban runoff has elevated concentrations of both phosphorus and nitrogen, which can enrich streams, lakes, reservoirs and estuaries (known as eutrophication). In particular, excess nutrients have been documented to be a major factor in the decline of Chesapeake Bay. Excess nutrients promote algal growth that blocks sunlight from reaching underwater grasses and depletes oxygen in bottom waters. Urban runoff has been identified as a key and controllable source of nutrients.

Figure 1: Water Balance at a Developed and Undeveloped Site

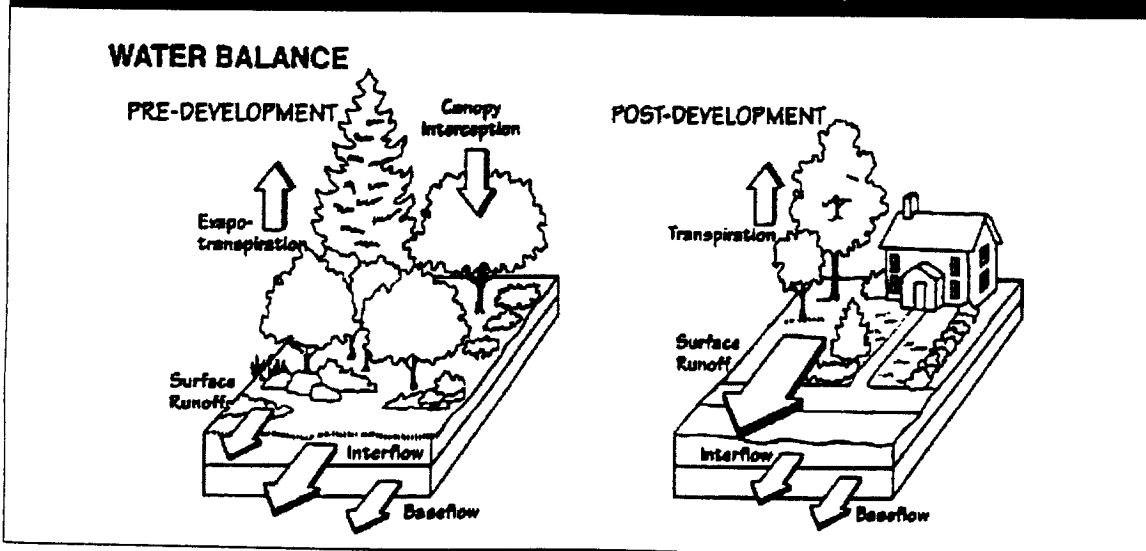

R0079816

Table 1: Typical Pollutant Concentrations Found in Urban Stormwater

Typical Pollutants Found in Stormwater Runoff	Units	Average Concentration (1)
Total Suspended Solids	mg/l	80
Total Phosphorus	mg/l	0.30
Total Nitrogen	mg/l	2.0
Total organic Carbon	mg/l	12.7
Fecal Coliform Bacteria	MPN/100 ml	3600
E. coli Bacteria	MPN/100 ml	1450
Petroleum Hydrocarbons	mg/l	3.5
Cadmium	ug/l	2
Copper	ug/l	10
Lead	ug/l	18
Zinc	ug/l	140
Chlorides (winter only)	mg/l	230
Insecticides	ug/l	0.1 to 2.0
Herbicides	ug/l	1 to 5.0

(1) these concentrations represent *mean or median* storm concentrations measured at typical sites, and may be greater during individual storms. Also note that mean or median runoff concentrations from *stormwater hotspots* are 2 to 10 times higher than those shown here. Units = mg/l = milligrams/liter, ug/l = micrograms/liter.

Data Source: Maryland Department of Environment. 2000. *Maryland Stormwater Manual, Vol. 1*. Baltimore, D. 212 pp.

Runoff Coefficient (Rv)

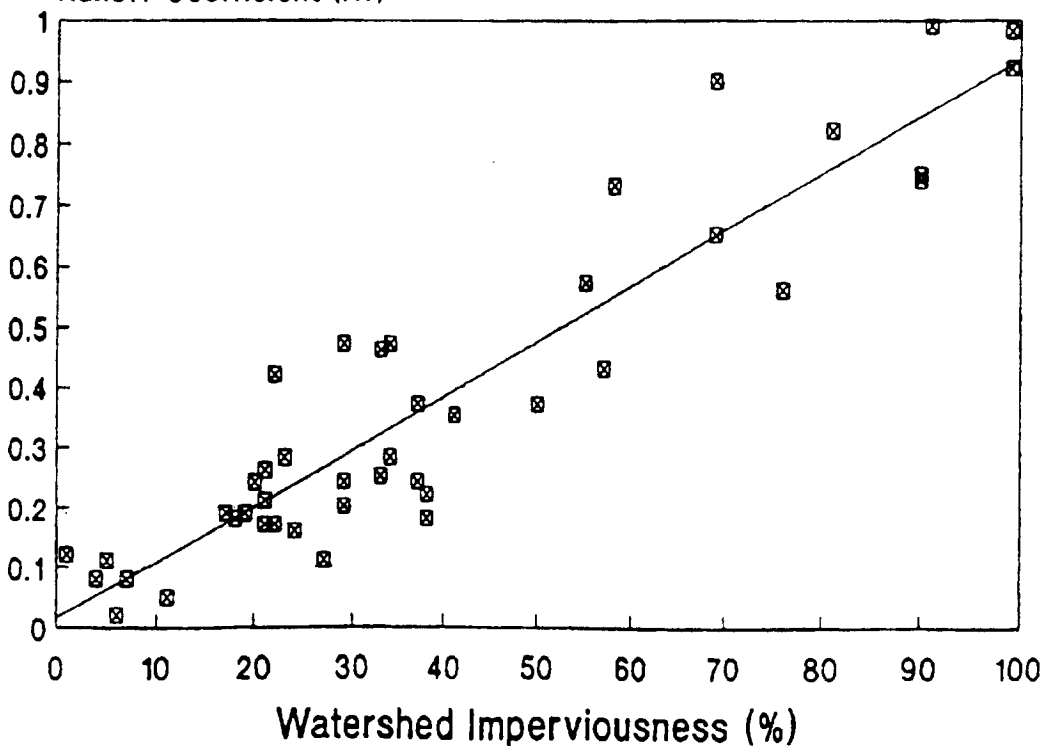

Figure 2: Relationship Between Impervious Cover and the Volumetric Runoff Coefficient

*Suspended solids.* Sources of sediment include washoff of particles that are deposited on impervious surfaces and erosion from streambanks and construction sites. Both suspended and deposited sediments can have adverse effects on aquatic life in streams, lakes and estuaries. Sediments also transport other attached pollutants.

*Organic Carbon.* Organic matter, washed from impervious surfaces during storms, can present a problem in slower moving downstream waters. As organic matter decomposes, it can deplete dissolved oxygen in lakes and tidal waters. Low levels of oxygen in the water can have an adverse impact on aquatic life.

*Bacteria.* Bacteria levels in stormwater runoff routinely exceed public health standards for water contact recreation. Stormwater runoff can also lead to the closure of adjacent shellfish beds and swimming beaches and may increase the cost of treating drinking water at water supply reservoirs.

*Hydrocarbons.* Vehicles leak oil and grease which contain a wide array of hydrocarbon compounds, some of which can be toxic at low concentrations to aquatic life.

*Trace Metals.* Cadmium, copper, lead and zinc are routinely found in stormwater runoff. These metals can be toxic to aquatic life at certain concentrations, and can also accumulate in the sediments of streams, lakes and estuaries.

*Pesticides.* A modest number of currently used and recently banned insecticides and herbicides have been detected in urban streamflow at concentrations that approach or exceed toxicity thresholds for aquatic life.

*Chlorides.* Salts that are applied to roads and parking lots in the winter months appear in stormwater runoff and meltwater at much higher concentrations than many freshwater organisms can tolerate.

*Thermal Impacts.* Impervious surfaces may increase temperature in receiving waters, adversely impacting aquatic life that requires cold and cool water conditions (e.g., trout).

*Trash and Debris.* Considerable quantities of trash and debris are washed through the storm drain networks. The trash and debris accumulate in streams and lakes and detract from their natural beauty.

### Diminishing Groundwater Recharge and Quality

The slow infiltration of rainfall through the soil layer is essential for replenishing groundwater. The amount of rainfall that recharges groundwater varies, depending on the slope, soil, and vegetation. Some indication of the importance of recharge is shown in Table 2, which shows Natural Resources Conservation Service (NRCS) regional estimates of average annual recharge volume, based on soil type.

Table 2: NRCS Estimates of Annual Recharge Rates, Based on Soil Type

Hydrologic Soil Group (NRCS)	Average Annual Recharge Volume
"A" Soils	18 inches/year
"B" Soils	12 inches/year
"C" Soils	6 inches/year
"D" Soils	3 inches/year
Average annual rainfall is about 40 inches per year across Maryland.	

Groundwater is a critical water resource across the county. Not only do many residents depend on groundwater for their drinking water, but the health of many aquatic systems is also dependent on its steady discharge. For example, during periods of dry weather, groundwater sustains flows in streams and helps to maintain the hydrology of non-tidal wetlands (Figure 3). Because development creates impervious surfaces that prevent natural recharge, a net decrease in groundwater recharge rates can be expected in urban watersheds. Thus, during prolonged periods of dry weather, streamflow sharply diminishes. In smaller headwater streams, the decline in stream flow can cause a perennial stream to become seasonally dry.

Urban land uses and activities can also degrade groundwater quality, if stormwater runoff is directed into the soil without adequate treatment. Certain land uses and activities are known to produce higher loads of metals and toxic chemicals and are designated as *stormwater hotspots*. Soluble pollutants, such as chloride, nitrate, copper, dissolved solids and some polycyclic aromatic hydrocarbons (PAHs) can migrate into groundwater and potentially contaminate wells. Stormwater runoff should never be infiltrated into the soil if a site is a designated hotspot.

### Degradation of Stream Channels

Stormwater runoff is a powerful force that influences the geometry of streams. After development, both the frequency and magnitude of storm flows increase dramatically (Figure 4). Consequently, urban stream channels experience more bankfull and sub-bankfull flow events each year than they had prior to development.

As a result, both the bed and bank of a stream are exposed to highly erosive flows more frequently and for longer intervals. Streams typically respond to this change by increasing their cross-sectional area to handle the more frequent and erosive flows either by channel widening or down cutting, or both. The stream enters a



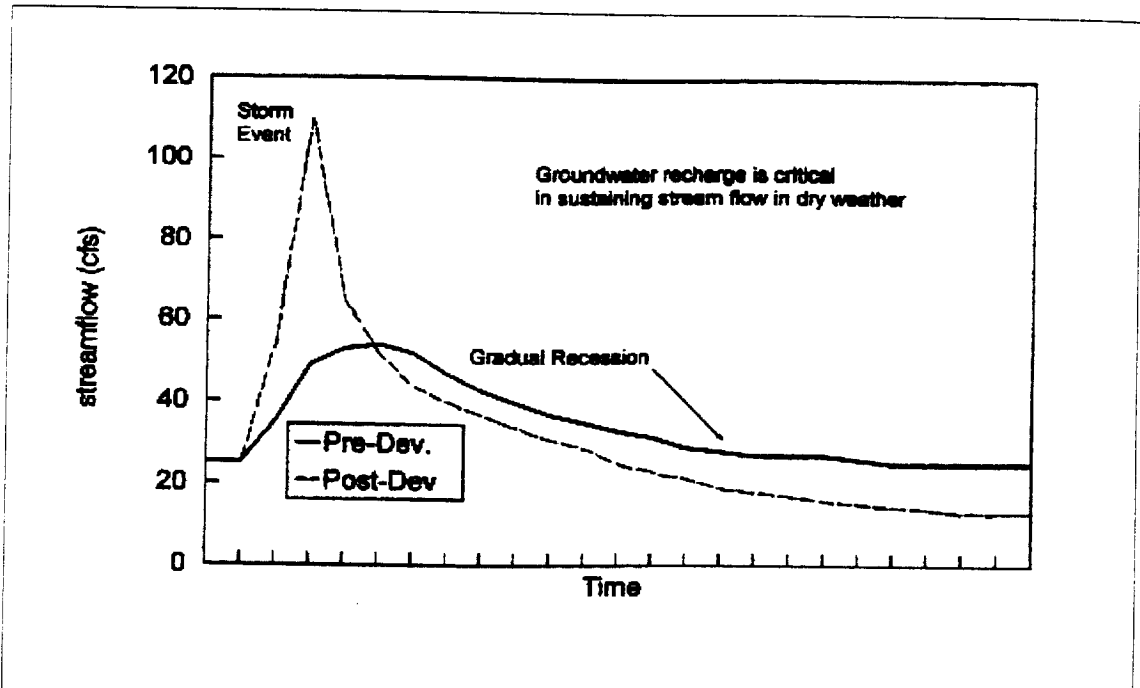

Figure 3: Decline in Streamflow Due to Diminished Groundwater Recharge

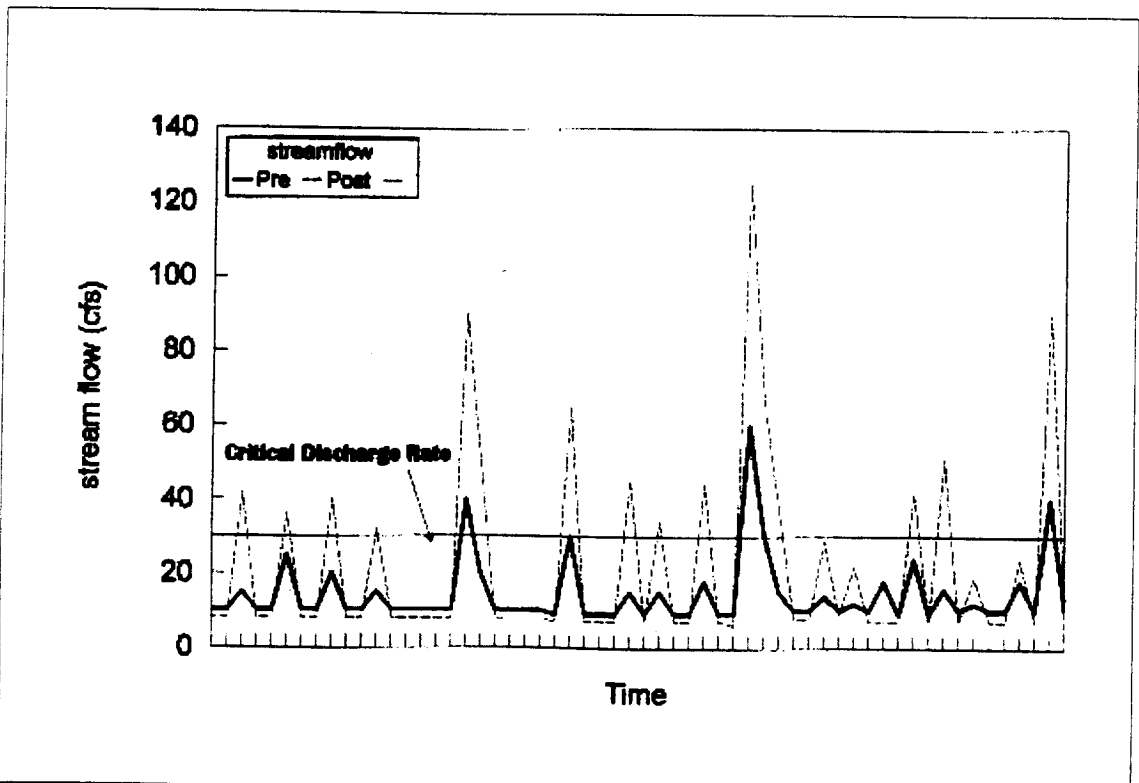

Figure 4: Increased Frequency of Critical Erosive Velocities in a Stream Channel after Development

8

highly unstable phase, and experiences severe streambank erosion and habitat degradation. In this phase, the stream often experiences some of the following changes:

- Rapid stream widening
- Increased streambank and channel erosion
- Decline in stream substrate quality (through sediment deposition and embedding of the substrate)
- Loss of pool/riffle structure in the stream channel
- Degradation of stream habitat structure
- Creation of fish barriers by culverts and other stream crossings.

The decline in the physical habitat of the stream, coupled with lower base flows and higher stormwater pollutant loads, has a severe impact on the aquatic community. Recent research has shown the following changes in stream ecology:

- Decline in aquatic insect and freshwater mussel diversity
- Decline in fish diversity
- Degradation of trout habitat

Traditionally, communities have attempted to provide some measure of channel protection by imposing the two-year storm peak discharge control requirement, which requires that the peak discharge from the two-year post-development storm be reduced to pre-development levels. Recent research and experience however, indicates that the two-year peak discharge criterion is not capable of protecting downstream channels

from erosion. In some cases, the two-year storm criteria may actually accelerate streambank erosion, because it exposes the channel to a longer duration of erosive flows than it would have otherwise received.

### Increased Overbank Flooding

Flow events that exceed the capacity of the stream channel spill out into the adjacent floodplain. These are termed "overbank" floods, and can damage property and downstream drainage structures.

While some overbank flooding is inevitable and even desirable, the historical goal of drainage design in many communities has been to maintain pre-development peak discharge rates for both the two and ten-year frequency storm after development, thus keeping the level of overbank flooding the same over time. This prevents costly damage or maintenance for culverts, drainage structures, and swales.

Overbank floods are ranked in terms of their statistical return frequency. For example, a flood that has a 50% chance of occurring in any given year is termed a "two year" flood. The two-year storm is also known as the "bankfull flood," as researchers have demonstrated that most natural stream channels in the state have just enough capacity to handle the two-year flood before spilling out into the floodplain. In Maryland, about three to 3.5 inches of rain in a 24-hour period produces a two-year or bankfull flood. This rainfall depth is termed the two-year design storm.

### STREAMFLOW

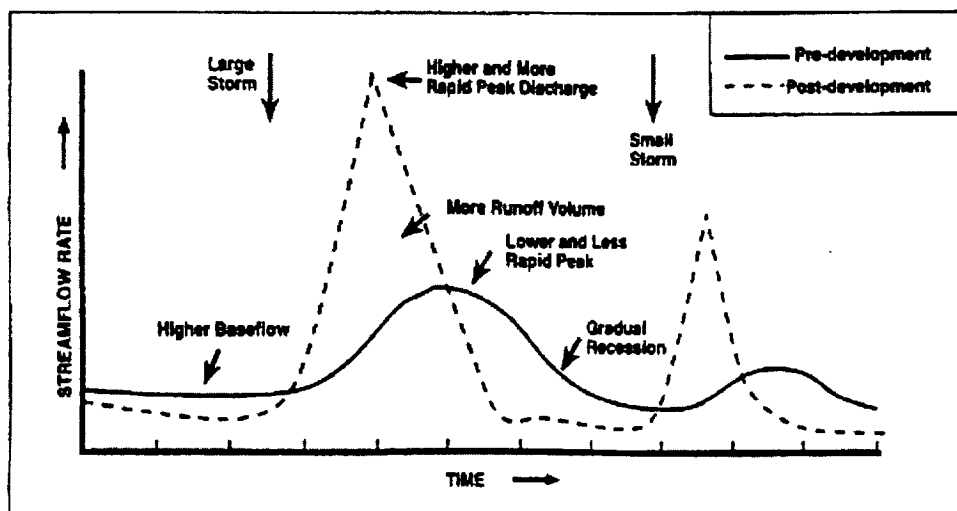

Figure 5: Change in Hydrograph Following Development

R0079820

Similarly, a flood that has a 10% chance of occurring in any given year is termed a "10-year flood." A 10-year flood occurs when a storm event produces about 4.5 to 5.5 inches of rain in a 24-hour period. Under traditional engineering practice, most channels and storm drains in Maryland are designed with enough capacity to safely pass the peak discharge from the 10-year design storm.

Urban development increases the peak discharge rate associated with a given design storm, because impervious surfaces generate greater runoff volumes and drainage systems deliver it more rapidly to a stream. The change in post-development peak discharge rates that accompany development is profiled in Figure 5.

#### Floodplain Expansion

The level areas bordering streams and rivers are known as floodplains. Operationally, the floodplain is usually defined as the land area that is inundated by the 100-year storm flow. The 100-year storm has a 1% chance of occurring in any given year. In Maryland, a 100-year flood occurs after about seven to eight inches of rainfall in a 24-hour period (i.e., the 100-year storm). These floods can be very destructive, and can pose a threat to property and human life.

Floodplains are natural flood storage areas and help to attenuate downstream flooding. Floodplains are very important habitat areas, encompassing riparian forests, wetlands, and wildlife corridors. Consequently, many communities restrict or even prohibit new development within the 100-year floodplain to prevent flood hazards and conserve habitats. Nevertheless, prior development that has occurred in the floodplain can still be subject to periodic flooding during these storms.

As with overbank floods, development sharply increases the peak discharge rate associated with the 100-year design storm. As a consequence, the elevation of a stream's 100-year floodplain becomes higher and the boundaries of its floodplain expand (see Figure 6). In some instances, property and structures that had not previously been subject to flooding are now at risk. Additionally, such a shift in a floodplain's hydrology can degrade wetlands and forest habitats.

#### Summary

The many changes in hydrology and water quality caused by urban development present the stormwater manager with hard choices about which storm events to treat, and which stormwater practices with which to treat them. These are described in the ensuing articles.

-TRS

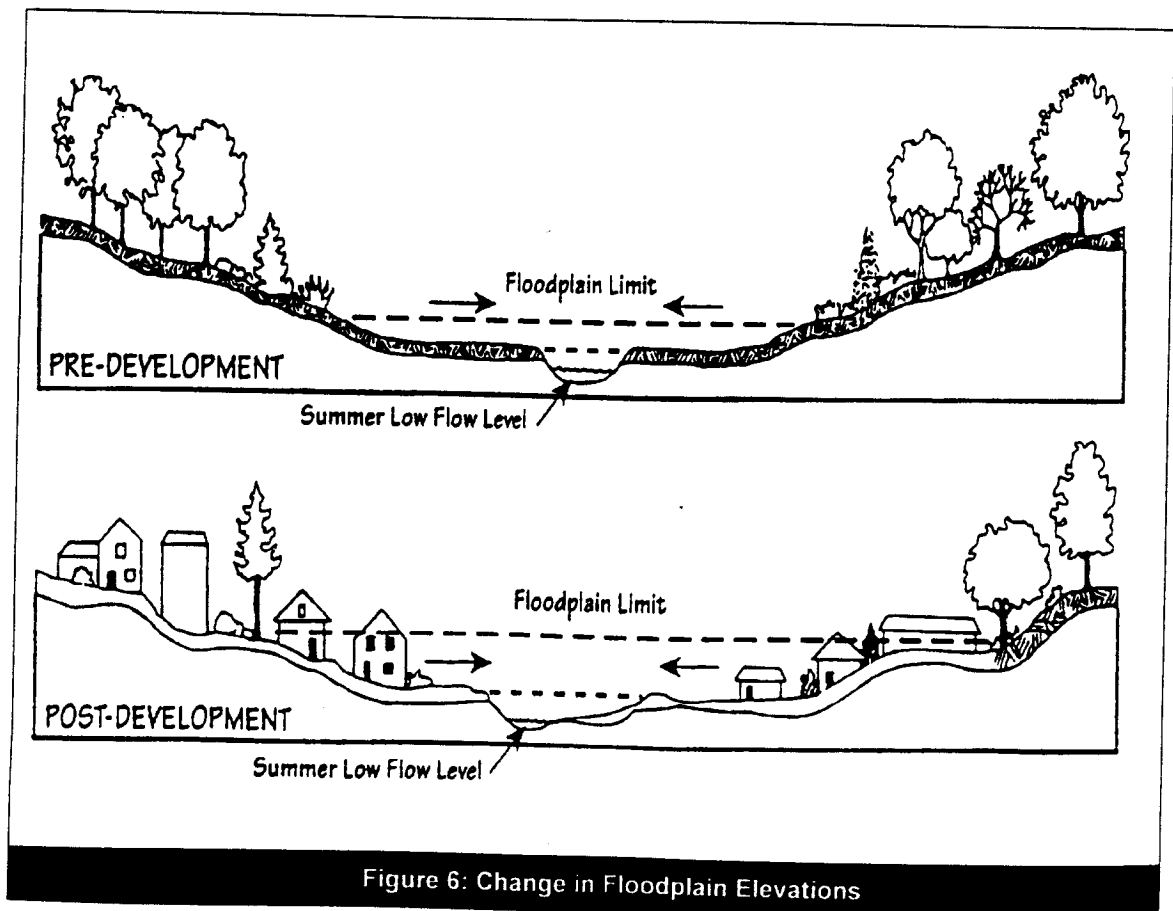

Figure 6: Change in Floodplain Elevations



# Comparative Pollutant Removal Capability of Stormwater Treatment Practices

Over the last two decades, an impressive amount of research has been undertaken to document the pollutant removal capability of urban stormwater treatment practices. The Center has recently developed a national database that contains more than 135 individual stormwater practice performance studies. The goals for this project were to generate national statistics about the pollutant removal capability of various groups of stormwater practices and to highlight gaps in our knowledge about pollutant removal.

The database was compiled after an exhaustive literature search of past monitoring studies from 1990 to the present. About 60 earlier monitoring studies had been collected in prior literature syntheses (Strecker *et al.*, 1992; Schueler, 1994). To be included in the database, a performance monitoring study had to meet three minimum criteria: a) collect at least five storm samples, b) employ automated equipment that enabled taking flow or time-based composite samples, and c) have written documentation of the method used to compute removal efficiency. A total of 139 studies in the current phase of the project met these criteria.

Once in the database, a few general conventions were needed to facilitate the statistical analysis. First, related measurements of water quality parameters were lumped together in the pollutant removal analysis (e.g., "soluble phosphorus" included ortho-phosphorus, biologically available phosphorus, and soluble reactive phosphorus; "organic carbon" lumps biological oxygen demand, chemical oxygen demand and total organic carbon removals, "hydrocarbons" can refer to oil/grease or total petroleum hydrocarbons and "soluble nitrogen" refers to nitrate + nitrite or nitrate alone.

Second, if more than one method was used to calculate pollutant removal, methods that compared the input and output of mass rather than concentrations were used. Third, if the monitoring study only recorded removal in terms of "no significant difference" in concentrations, these were registered as zero removals. Similarly, studies that reported unspecified negative removals were entered as minus 25% (mean of negative values where specified). Finally, performance studies reporting negative removals greater than 100% were limited to minus 100% to prevent undue bias in the data set.

Each study was then assigned to one of five general stormwater practice groups: ponds, wetlands, open channels, filters, and infiltration practices. Each group was further subdivided according to design variations. For example, the pond group includes detention ponds, dry extended detention (ED) ponds, wet ponds and wet ED ponds. Medians were used as the measure of central tendency for all stormwater practice groups and design variations, and are only reported if sample size exceeded five monitoring studies. In general, pollutant removal rates should be considered as *initial* estimates of stormwater practice performance as studies occurred within three years of practice construction.

As always, extreme caution should be exercised when stormwater management performance studies are compared. Individual studies often differ in the number of storms sampled, the manner in which pollutant removal efficiency is computed (e.g., as a general rule, the concentration-based technique often results in slightly lower efficiency than the mass-based technique), the monitoring technique employed, the internal geometry and storage volume provided by the practice design, regional differences in soil type, rainfall, latitude, and the size and land use of the contributing catchment. In addition,

**Table 1: Seldom-Monitored Stormwater Management Practices (National Urban BMP Database, 1997)**

Number of Stormwater Practice Design	Monitoring Studies
Biofilter	0
Filter/Wetland Systems	0
Filter Strips	0
Infiltration Basins	0
Bioretention	1
Wet Swale	2
Gravel-based Wetlands	2
Infiltration Trench	3
Porous Pavement	3
Perimeter Sand Filter	3



**Table 2: Frequency that Selected Stormwater Pollutants Were Monitored In 123 BMP Performance Studies**

Stormwater Parameter	Percent of Studies that Measured It
Total Phosphorus	94
Total Suspended Solids (TSS)	94
Nitrate-Nitrite Nitrogen	71
Total Zinc	71
Total Lead	65
Organic Carbon	56
Soluble Phosphorus	55
Total Nitrogen	54
Total Copper <sup>a</sup>	46
Bacteria	19
Total Cadmium <sup>a</sup>	19
Total Dissolved Solids	13
Dissolved Metals	10
Hydrocarbons	9

<sup>a</sup> Excludes studies where parameter was below detection limits.

pollutant removal percentages can be strongly influenced by the variability of the pollutant concentrations in incoming stormwater. If the concentration is near the "irreducible level" (see Schueler, 1996), a low or negative removal percentage can be recorded, even though outflow concentrations discharged from the stormwater practice were actually relatively low.

**Gaps in the Stormwater Practice Performance Database**

A key element of the database project was to identify current gaps in stormwater practice monitoring research. To this end, the entire database was analyzed to find practices that had seldom been monitored and identify key stormwater pollutants that were not frequently sampled. This information is helpful for setting future monitoring priorities in order to close these research gaps.

Key gaps in our current knowledge about urban stormwater management practice performance are shown in Table 1. As can be seen, the pollutant removal performance of 10 commonly-used practice designs have been tested less than four times. Consequently, we have less confidence in the computed removal rates for these practices. Perhaps the most critical gap in

stormwater practice performance research exists for infiltration and bioretention practices, which, as of yet, have never been adequately monitored in the field. To some extent, the lack of performance monitoring reflects the fact that stormwater enters these practices in sheetflow and often leaves them by exfiltrating into the soil over a broad area. Since runoff is never concentrated, it is extremely difficult to collect representative samples of either flow or concentration that are needed to evaluate removal performance. This sampling limitation has also made assessment of filter strips problematic.

More research on the performance of water quality swales (i.e., dry swales and wet swales) appears warranted, because so few have been monitored, and the recorded removal rates are so different. The performance of other stormwater practices have not been scrutinized either because they are relatively new (i.e., organic filters and submerged gravel wetlands) or are smaller versions of frequently sampled practices (i.e., pocket wetlands and ponds).

While ponds, wetlands, sand filters and open channels have been extensively monitored in the field (10 to 30 studies each), significant gaps exist with respect to individual stormwater parameters (Table 2). In particular, stormwater practice pollutant removal data is scarce with respect to bacteria, hydrocarbons, and dissolved metals. These three parameters have only been measured in 10 to 20% of all stormwater practice performance studies, despite their obvious implications for human health, recreation, and aquatic toxicity. A greater focus on these important parameters is warranted in future monitoring efforts.

**Comparison of Stormwater Practice Pollutant Removal Performance**

The comparative removal efficiency of stormwater practice groups is shown in Figures 1 and 2 for a series of commonly sampled parameters. These "box and whisker" plots depict the statistical distribution of removal rates: the "whiskers" show the minimum and maximum values, whereas the "box" delimits where half of all values lie (range between 25 and 75% quartile). Thus, the more compact the box, the less variable the data. The line inside the box denotes the median value. Medians and sample sizes are also shown in Tables 3 and 4.

As both plots clearly show, performance can be extremely variable for many parameters within a group of stormwater management practices. (This is in addition to similar variability frequently seen from storm to storm, within an individual stormwater practice). Consequently, estimates of stormwater practice performance should not be regarded as a fixed or constant value, but merely as a long-run average.



Figure 1: Comparative Distribution of Pollutant Removal Rates by Practice Group–Nutrients

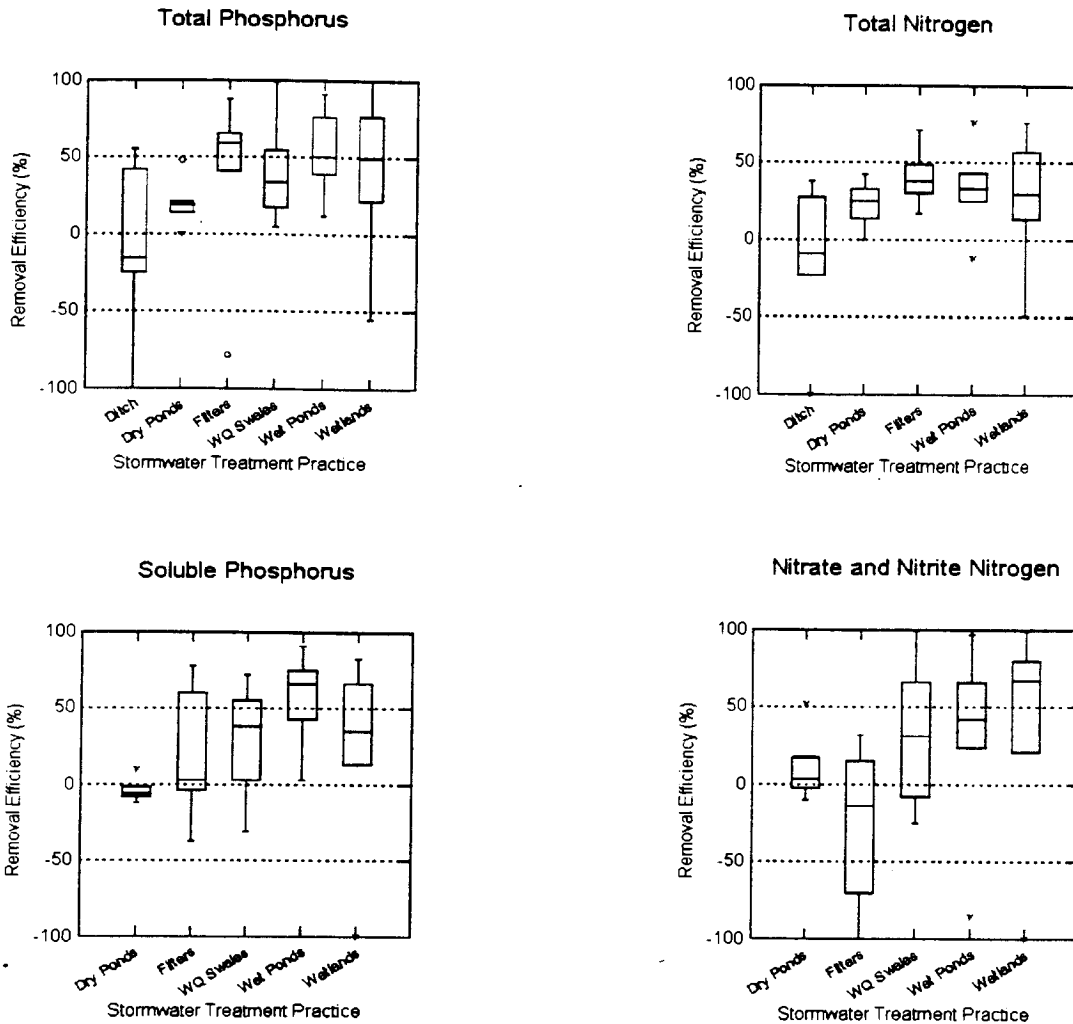

### Phosphorus

While variable, most practice groups were found to have median removal rates in the 30 to 60% range for both soluble and total phosphorus. Once again, dry ponds and ditches showed low or negative ability to remove either phosphorus form. Interestingly, several practice groups exhibited very wide variation in phosphorus removal (e.g., note the large size of boxes for wetlands, water quality swales and sand filters). While sand filters were found to be effective in removing total phosphorus, they often exported soluble phosphorus.

### Nitrogen

Most stormwater practice groups, on the other hand, showed a lower ability to remove total nitrogen, with typical median removal rates on the order 15 to 35%. In contrast to phosphorus, most practice groups showed

relatively low variation in total nitrogen removal. The groups differed greatly in their ability to remove soluble nitrogen. In a broad sense, the stormwater practice groups could be divided into two categories: "nitrate leakers" and "nitrate-keepers." Nitrate leakers tend to have low or even negative removal of this soluble form of nitrogen, and included filters, ditches, and dry ponds. In these practices, organic nitrogen is converted to nitrate in the nitrification process, but conditions do not allow for subsequent denitrification. Thus, these "leakers" produce more nitrate than is delivered to them. Nitrate keepers tend to have moderate removal rates and include wet ponds, wet ED ponds and shallow marsh. In these practices, algal and other plants take up nitrate, and incorporate it into organic nitrogen. Thus, "keepers" tend to remove more nitrate than is delivered to them. Some practice groups, such as water quality swales and pond/wetland systems, exhibit such wide



Figure 2: Comparative Distribution of Pollutant Removal Rates for Practice Groups—TSS, Carbon, Zinc and Copper

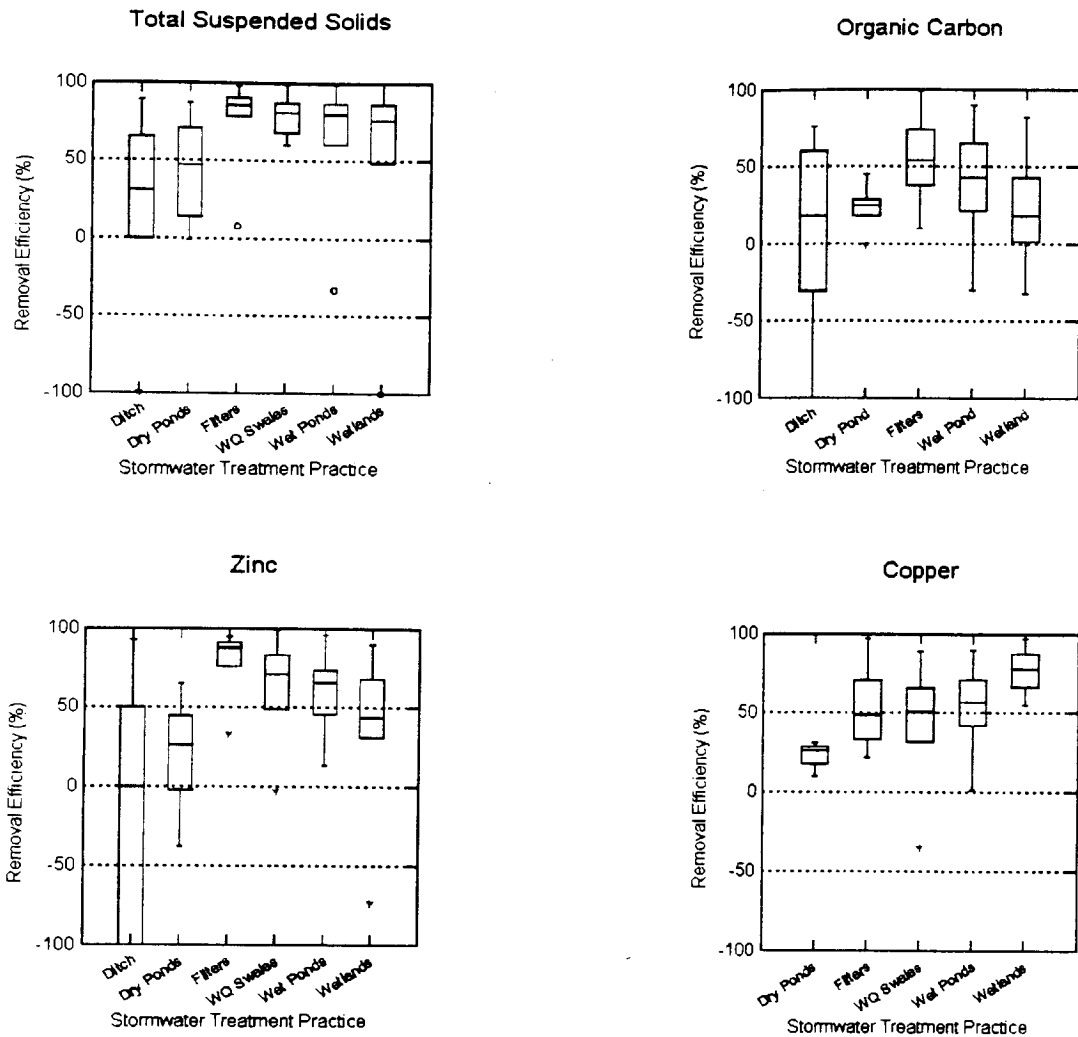

variability, that it is likely that some practices are acting as nitrate leakers and others as nitrate keepers.

#### Suspended Sediment

Most stormwater practice groups exhibited a strong capability to remove suspended sediment, with median removals ranging from 60 to 85% for most groups. The highest median removal was noted for sand filters, water quality swales, infiltration practices, and shallow marsh systems (all slightly above 80%). Most pond and wetland designs approached but did not surpass the 80% TSS removal threshold specified in Costal Zone Act Reauthorization Amendments (CZARA) Section 6217 (g) guidance. Ditches exhibited the greatest variability, and had a median sediment removal rate of 31%.

#### Carbon

The ability of urban stormwater management practices to remove organic carbon or oxygen demanding material, while quite variable, was generally fairly modest, with median removal rates on the order of 20 to 40%. A notable exception was water quality swales, which exhibited median removal rates in excess of 65%. It should be noted that some variability in carbon removal rates could be due to the lumping of total organic carbon, BOD, and COD together.

#### Trace Metals

Most stormwater practice groups displayed a moderate to high ability to remove total lead, and zinc from urban runoff. Typical median removal rates were on the order of 50 to 80%. Exceptions included open

**Table 3: Comparison of Median Pollutant Removal Efficiencies  
Among Selected Practice Groups: Conventional Pollutants**

Practice Groups	N	Median Removal Rate For Stormwater Pollutants (%)					
		TSS	TP	Sol P	Total N	NOx	Carbon
Detention Pond	3	7	19	0	5	9	8
Dry ED Pond	6	61	20	(-11)	31	(-2)	28
Wet Pond	29	79	49	62	32	36	45
Wet ED Pond	14	80	55	67	35	63	36
<b>PONDS <sup>a</sup></b>	<b>44</b>	<b>80</b>	<b>51</b>	<b>66</b>	<b>33</b>	<b>43</b>	<b>43</b>
Shallow Marsh	23	83	43	29	26	73	18
ED Wetland	4	69	39	32	56	35	ND
Pond/Wetland	10	71	56	43	19	40	18
<b>WETLANDS</b>	<b>39</b>	<b>76</b>	<b>49</b>	<b>36</b>	<b>30</b>	<b>67</b>	<b>18</b>
Surface Sand Filters	8	87	59	(-17)	32	(-13)	67
<b>FILTERS <sup>b</sup></b>	<b>19</b>	<b>86</b>	<b>59</b>	<b>3</b>	<b>38</b>	<b>(-14)</b>	<b>54</b>
<b>INFILTRATION</b>	<b>6</b>	<b>95</b>	<b>70</b>	<b>85</b>	<b>51</b>	<b>82</b>	<b>88</b>
<b>WQ SWALES <sup>c</sup></b>	<b>9</b>	<b>81</b>	<b>34</b>	<b>38</b>	<b>84</b>	<b>31</b>	<b>69</b>
<b>DITCHES</b>	<b>11</b>	<b>31</b>	<b>(-16)</b>	<b>(-25)</b>	<b>(-9)</b>	<b>24</b>	<b>18</b>

N = Number of performance monitoring studies. The actual number for a given parameter is likely to be slightly less.  
Sol P = Soluble phosphorus, as measured as ortho-P, soluble reactive phosphorus or biologically available phosphorus.  
Total N = Total Nitrogen. Carbon = Measure of organic carbon (BOD, COD or TOC).

<sup>a</sup> Excludes conventional and dry ED ponds.

<sup>b</sup> Excludes vertical sand filters and vegetated filter strips.

<sup>c</sup> Includes biofilters, wet swales and dry swales.

**Table 4: Median Stormwater Pollutant Removal Reported for Selected Practice Groups –  
Fecal Coliform Bacteria, Hydrocarbons and Selected Trace Metals**

Practice Groups	Median Stormwater Pollutant Removal <sup>d</sup>					
	Bacteria <sup>e</sup>	HC <sup>f</sup>	Cd	Copper	Lead	Zinc
Detention and Dry ED Ponds	78	ND	32%	26%	54%	26%
<b>PONDS <sup>a</sup></b>	<b>70</b>	<b>81</b>	<b>50</b>	<b>57</b>	<b>74</b>	<b>66</b>
<b>WETLANDS</b>	<b>78</b>	<b>85</b>	<b>69</b>	<b>40</b>	<b>68</b>	<b>44</b>
<b>FILTERS <sup>b</sup></b>	<b>37</b>	<b>84</b>	<b>68</b>	<b>49</b>	<b>84</b>	<b>88</b>
<b>INFILTRATION</b>	<b>ND</b>	<b>ND</b>	<b>ND</b>	<b>ND</b>	<b>98</b>	<b>99</b>
<b>WQ SWALES <sup>c</sup></b>	<b>(-25)</b>	<b>62</b>	<b>42</b>	<b>51</b>	<b>67</b>	<b>71</b>
<b>DITCHES</b>	<b>5</b>	<b>ND</b>	<b>38</b>	<b>14</b>	<b>17</b>	<b>0</b>

<sup>a</sup> Excludes dry ED and conventional detention ponds.

<sup>b</sup> Excludes vertical sand filters and vegetated filter strips.

<sup>c</sup> Includes biofilters, wet swales and dry swale.

<sup>d</sup> N is less than 5 for some BMP groups for bacteria, TPH and Cd, and medians should be considered provisional.

<sup>e</sup> Bacteria values represent mean removal rates.

<sup>f</sup> HC = hydrocarbons measured as total petroleum hydrocarbons or oil/grease.

**R0079826**

channels and dry ED ponds that were generally ineffective at promoting settling. Median copper removal rates ranged from 40 to 60%, with highest removals seen for the water quality swales, wet ponds, and filters. It should be noted that only 10% of all stormwater practice studies measured soluble metal removal which is widely thought to be a better indicator of potential aquatic toxicity than total metals (which includes metals that are tightly bound to particles). A quick review of the few studies that examined soluble metals suggests that while removal was usually positive, it was almost always lower than total metal removal.

#### *Bacteria*

The limited monitoring of fecal coliform did not allow for intensive statistical analysis of the effectiveness of stormwater practice groups in removing bacteria from urban runoff. Preliminary mean fecal coliform removal rates ranged from 65 to 75% for ponds and wetlands, and 55% for filters. Based on very limited data, ditches were found to have no bacteria removal capability, while water quality swales consistently exported bacteria. To put the removal data in perspective, a 95 to 99% removal rate is generally needed in most regions to keep bacteria levels under recreational water quality standards.

#### *Hydrocarbons*

The limited monitoring data available suggested that most stormwater practice groups can remove most petroleum hydrocarbons from stormwater runoff. For example, ponds, wetlands, and filters all had median removal rates on the order of 80 to 90%, and water quality swales were rated at 62%. In general, the ability of a practice group to remove hydrocarbons was closely related to its ability to remove suspended sediment. In nearly every case, hydrocarbon removal was within 15% of observed sediment removal.

#### **Implications**

This re-analysis of stormwater treatment practice performance has several implications for watershed managers. For the first time, there is enough data to select specific practice groups on the basis of their comparative ability to remove specific pollutants. A second implication is that the pond and wetland practice groups have similar removal capabilities, although the pollutant removal capability of wetlands appears to be more variable than ponds. Infiltration practices do appear to have the highest overall removal capability of any practice group, whereas dry ED ponds and ditches have extremely limited removal capability. Water quality swales show promise for some pollutants but not for biologically available phosphorus.

Significant gaps do exist in our knowledge in regard to the removal capability of certain practice designs and stormwater parameters. Filling these gaps should be the major focus of future stormwater practice monitoring research. For the more well-studied practice groups (ponds, wetlands, and filters) research should be re-directed to investigate internal factors (geometry, sediment/water column interactions, etc.) that can cause the wide variability in pollutant removal that is so characteristic of stormwater practice monitoring. Such research could be of great value in developing better design strategies to dampen pollutant removal variability, thereby improving reliability in achieving pollutant reduction goals at the watershed scale.

—TRS

#### **References**

- Brown, W., and T. Schueler. 1997. *Final Report: National Performance Database for Urban BMPs*. Prepared for Chesapeake Research Consortium. Center for Watershed Protection. Silver Spring, MD. 208 pp.
- Schueler, T. 1994. "Review of Pollutant Removal Performance of Stormwater Ponds and Wetlands." Technical Note 6. *Watershed Protection Techniques* 1(1):17-18.
- Schueler, T. 1996. "Irreducible Pollutant Concentrations Discharged from Urban BMPs." Technical Note 75. *Watershed Protection Techniques* 2(2): 369-371.
- Strecker, E. 1992. "Pollutant Removal Performance of Natural and Created Wetlands for Stormwater Runoff." Final Report to U.S. EPA. Woodward Clyde Consultants, Inc. Portland, OR. 112 pp.

*Note: The Center updated its national stormwater treatment database in 2000. While the comparative pollutant removal performance did not change substantially, the reader may want to consult this significantly expanded database, which is available from the Center.*

R0079827

# Irreducible Pollutant Concentrations Discharged From Stormwater Practices

**L**oad reduction has traditionally been the criteria used to evaluate the performance of urban stormwater treatment practices. Simply put, the mass of stormwater pollutants entering a practice are compared against the mass leaving it (over a suitable time frame), and a percent removal efficiency is quickly computed. While load reduction is a useful criteria to compare the relative performance of different practices, it does have some limits. For example, it tells us very little about the concentration of pollutants leaving the practice. Outflow concentrations can be of considerable interest to a watershed manager. For example, is there a background level or irreducible concentration of stormwater pollutants discharged downstream that represents the best that can be achieved with current technology?

The concept of irreducible concentrations has been explicitly recognized for some years in process models used to design of wastewater treatment wetlands (Kadlec and Knight, 1996; Reed, 1995). The consensus of expert opinion is that surface flow wastewater wetlands cannot reduce sediment and nutrient concentrations beyond the rather low levels indicated in Table 1, no matter how much more surface area or treatment volume is provided.

Figure 1 illustrates the effect of an irreducible concentration on the treatment efficiency of a hypothetical stormwater practice. When incoming pollutant concentrations are moderate to high, for example, an increase in a treatment variable (such as area or volume) will result in a proportional reduction in the concentration of a pollutant leaving the practice (line A). If, however, the incoming pollutant concentration approaches the irreducible concentration, (denoted as C-star), it is not possible to change the outflow concentration very much, regardless of how much additional treatment is provided (line B). Indeed, when the incoming concentration is equal to or falls below the irreducible concentration, it is possible to experience negative removal, i.e., an increase pollutant concentration as it passes through the practice (line C).

Why do irreducible concentrations exist? To begin with, they often represent the internal production of nutrients and turbidity within a pond or wetland, due to biological production by microbes, wetland plants and algae. Some of these internal processes inevitably return some pollutants back into the water column, where

they may be displaced during the next storm event. In other cases, the irreducible concentration may simply reflect the limitations of a particular removal pathway utilized in a stormwater practice. For example, a practice that relies heavily on sedimentation for removal can have a relatively high C\*. This is evident in the settling column data presented in Figure 2 developed by Grizzard *et al.* (1986). When sedimentation is the sole removal pathway, the removal rates for a range of pollutants eventually become asymptotic, no matter much more detention time is provided.

Does a C\* exist for pollutants controlled by urban stormwater practices? Two recent studies suggest that irreducible concentrations do indeed exist. In the first study, Kehoe and his colleagues systematically analyzed the quality of stormwater in a series of 36 stormwater ponds and wetlands located in the greater Tampa Bay, Florida area. Researchers characterized the sediment, metal and dissolved oxygen content of water discharged from stormwater wet ponds (N=24) and pond/wetland systems (N=12) over a two-year period. Grab samples were collected from each site one to three days after storms occurred to represent post-storm discharges.

A summary of the study results are shown in Table 2 for the wet ponds and pond/wetland systems. Outflow TSS levels were remarkably consistent, at slightly less than 10 mg/l. Dissolved oxygen levels tended to be more variable, with slightly lower oxygen levels reported in wetland systems than ponds. Similarly, pH levels of pond/wetland systems were slightly more acidic than pond systems, presumably due to the greater amount of organic matter that accumulated in the wetlands. The

**Table 1: Irreducible Concentrations in Wastewater Wetlands and Stormwater Treatment Practices**

Water Quality Parameter (mg/l)	Wastewater (Kadlec and Knight 1996)	Wastewater (Reed 1995)	Stormwater Practices (this study)
Total Suspended Solids	2 to 15	8	20 to 40
Total Phosphorus	0.02 to 0.07	0.5	0.15 to 0.2
Total Nitrogen	1.0 to 2.5	1.0	1.9
Nitrate-Nitrogen	0.05	0.00	0.7
TKN	1.0 to 2.5	1.0	1.2

Figure 1: Effect of the Irreducible Concentration on Treatment Variables

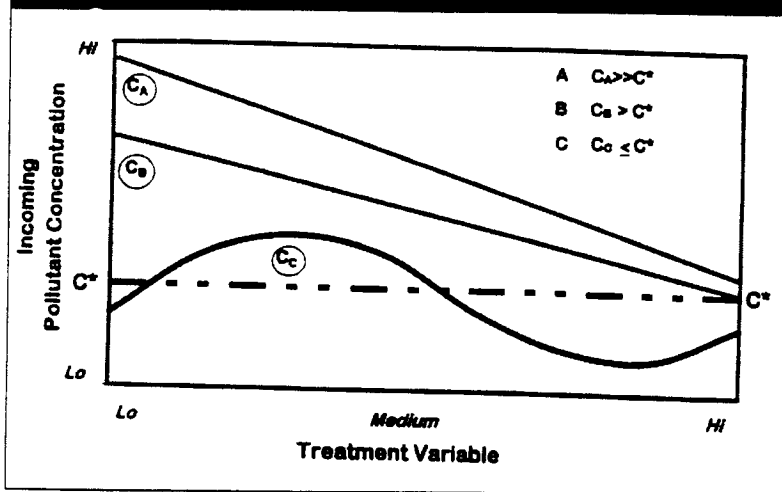
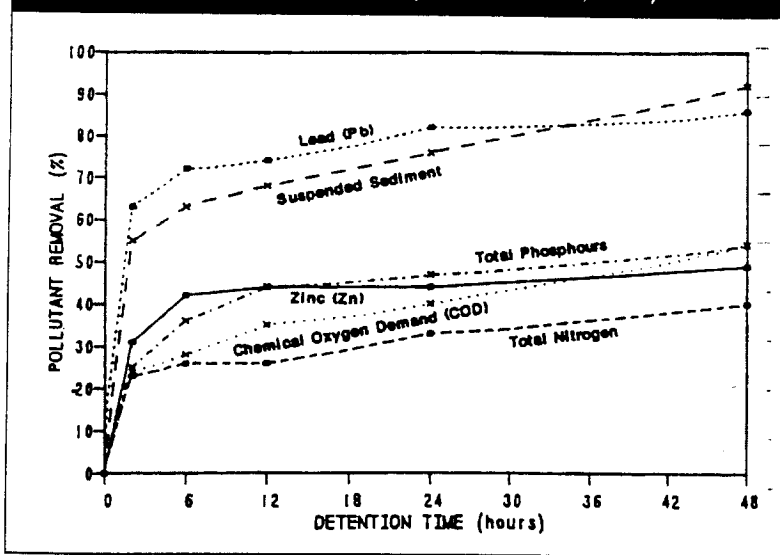

Figure 2: Removal Rate vs. Detention Time for a Series of Stormwater Pollutants (Grizzard et al., 1986)



majority of the monitoring data was for the metals (cadmium, chromium, copper, lead, nickel and zinc). While detection limit problems complicated the metal analysis, most metals were occasionally detected in pond outflows, sometimes at levels exceeding Florida metal criteria.

In the second study, this author analyzed published event mean concentrations (EMCs) in the outflows of 42 stormwater practices that had been subject to intensive performance monitoring. These post-NURP stormwater practice monitoring studies were conducted in many geographic regions (FL, TX, WA, MN, WI, MD, VA, CT, CO and New Zealand), and encompassed four broad types of practices: stormwater ponds, wetlands, filtering systems, and grassed channels. For each type

of practice, a group mean and standard deviation was computed based on the mean storm outflow concentrations of sediment and nutrients reported in each individual study (N ranged from three to 16). The results of the analysis are shown in Tables 3 to 6. Unlike the earlier study, these concentrations represent mean storm outflow concentrations (i.e., the partial or full displacement of runoff from the stormwater practice).

As can be seen in the tables, stormwater practice outflow concentrations exhibit a rather remarkable consistency within and among the four groups of stormwater practices, as typified by the fairly narrow range in both the computed mean and standard deviation. Interestingly, very little difference was observed in the group means of stormwater ponds and wetlands, particularly for most forms of nitrogen and phosphorus. In general, mean outflow concentrations were slightly lower for filtering systems, and somewhat higher for grass channels (this may reflect the mediocre performance of grass channels, as described in article 116). The one nitrogen form that did exhibit considerable variability in mean outflow concentrations among the four practice groups was nitrate-nitrogen. Nitrate outflow concentrations were greatest for filtering systems, intermediate for wet ponds and grassed channels, and lowest for stormwater wetlands. At the same time, total nitrogen concentrations were very consistent among the four groups of stormwater practices (1.6 to 1.9 mg/l). This result suggests that the four practice groups may differ in their internal rates of nitrification (that produces nitrate) and denitrification (that eliminates nitrate).

Based on this analysis, a preliminary estimate of the "irreducible" concentration of pollutants in stormwater practice outflows is suggested in Table 1. In general, the nutrient values are in the same range as those previously developed for wastewater wetlands, although the sediment concentrations are approximately two to four times higher.

#### Implications

The apparent existence of irreducible pollutant concentrations after stormwater treatment has several important ramifications for urban watershed managers. For example, an irreducible concentration can represent a real threshold for cumulative watershed impacts. The data suggests that a background storm phosphorus concentration of 0.10 to 0.15 mg/l is probably the lowest concentration that can be achieved through stormwater treatment, even when stormwater practices are widely applied and maintained. For some sensitive lake regions, this phosphorus level may still be too high to effectively prevent the onset of eutrophication.

Another ramification of irreducible concentrations relates to multiple stormwater practice systems. Some communities require that a series of practices be con-



structured to achieve a load reduction target of 80 or 90% removal. The existence of an irreducible concentration suggests that there are some practical limits to improving treatment efficiency with additional stormwater practices after a certain point. Quite simply, if the first practice reduces the pollutant concentration to near the irreducible concentration, it is not likely that a second or third practice will result in any further improvement.

Lastly, the existence of irreducible concentrations can help to interpret some of the notorious variability frequently seen in stormwater practice pollutant removal monitoring data. In many cases, the removal rate for a practice changes with each storm event. Some practices also exhibit wide variability in pollutant removal rates, even when their treatment volumes are similar. In both cases, a mediocre percentage pollutant removal may simply be a result of incoming pollutant concentrations that are very close to the irreducible concentration (and consequently, cannot be reduced much further). Consequently, investigators may want to look closely at their mean inflow concentrations before they assume poor performance is due to poor design or inadequate sampling.

While the concept of an irreducible concentration is an intriguing one, more outflow monitoring is needed to definitively characterize it for many stormwater practices. In particular, data are lacking on outflow concentrations for several key stormwater pollutants, such as bacteria and hydrocarbons. Based on these two studies, however, it is clear that there is a limit to stormwater treatment efficiency. Although the limit remains relatively low, both managers and regulators should keep it in mind when devising watershed protection or restoration programs.

-TRS

*Note: The Center has developed more extensive statistics on the irreducible concentrations of a greater number of stormwater practices in its 2000 update of the national stormwater treatment database, which is available from the Center.*

Table 2: Water Chemistry of Stormwater Pond and Wetlands in Tampa Bay, Florida  
(Kehoe, 1993 and Kehoe *et al.*, 1994)

Parameter (Units)	Stormwater Ponds N = 24 (236)	Pond/Wetlands N = 12 (83)
TSS (mg/l)	8.8 ± 11.4	9.1 ± 12.1
DO (mg/l)	5.7 ± 2.8	4.1 ± 3.8
pH	7.2	6.7 ± 0.9
Cadmium* (µg/l)	3 ± 6	6 ± 7
Chromium* (µg/l)	12 ± 26	5 ± 3
Copper* (µg/l)	16 ± 25	10 ± 10
Lead* (µg/l)	12 ± 28	BDL
Nickel* (µg/l)	9 ± 36	BDL
Zinc* (µg/l)	37 ± 73	33 ± 30
Water temperature (°C)	22.8	23.7

Notes: Grab samples taken 1 to 3 days following storm  
Means plus or minus one standard deviation  
N = Sites sampled (Total Samples all Sites)  
BDL = Below detection limits

\* Wide standard deviations may reflect detection limit problems for metals

Table 3: Mean Storm Outflow Concentrations From Stormwater Wetlands

Parameter	N	Concentration (mg/l)
Total Suspended Solids	15	32 ± 25.8
Total Phosphorus	16	0.19 ± 0.13
Ortho-Phosphorus	14	0.08 ± 0.04
Total Nitrogen	11	1.63 ± 0.48
Total Kjeldahl Nitrogen	11	1.29 ± 0.43
Nitrate-Nitrogen	11	0.35 ± 0.28

Notes: Group means plus or minus one standard deviation

Table 4: Mean Storm Outflow Concentrations From Wet and Extended Detention Ponds

Parameter	N	Concentration (mg/l)
Total Suspended Solids	11	35.0 ± 19.0
Total Phosphorus	11	0.22 ± 0.12
Ortho-Phosphorus	6	0.08 ± 0.04
Total Nitrogen	11	1.91 ± 0.56
Total Kjeldahl Nitrogen	11	1.21 ± 0.36
Nitrate-Nitrogen	11	0.70 ± 0.36

Notes: Group means plus or minus one standard deviation

**Table 5 Storm Outflow Concentrations From Stormwater Filtering Systems (Sand Filters and Compost Filters)**

Parameter	N	Concentration (mg/l)
Total Suspended Solids	10	19.3 ± 10.1
Total Phosphorus	10	0.14 ± 0.13
Ortho-Phosphorus	ND	-
Total Nitrogen	6	1.93 ± 1.02
Total Kjeldahl Nitrogen	6	0.90 ± 0.52
Nitrate-Nitrogen	6	1.13 ± 0.55

Notes: Group means plus or minus one standard deviation

**Table 6: Storm Outflow Concentrations From Grass Drainage Channels**

Parameter	N	Concentration (mg/l)
Total Suspended Solids	5	43.4 ± 47.0
Total Phosphorus	5	0.33 ± 0.15
Ortho-Phosphorus	3	0.16
Total Nitrogen	5	1.74 ± 0.71
Total Kjeldahl Nitrogen	5	1.19 ± 0.41
Nitrate-Nitrogen	5	0.55 ± 0.29

Notes: Group means plus or minus one standard deviation

The limited number of studies available limits the accuracy of the estimates

**References**

Grizzard, T, C. Randall, B. Weand, and K. Ellis. 1986. "Effectiveness of Extended Detention Ponds." in *Urban Runoff Quality-Impact and Quality Enhancement Technology*. B. Urbonas and L. Roesner (editor). American Society of Civil Engineers. New York, NY. pp. 323-338.

Kadlec, R and R. Knight. 1996. *Treatment Wetlands*. CRC Press and Lewis Publishers. Boca Raton, FL. 894 pp.

Kehoe, M. J. 1993. *Water Quality Survey of Twenty-Four Stormwater Wet Detention Ponds - Final Report*. Southwest Florida Water Management District. Brooksville, FL. 84 pp.

Kehoe, M, C. Dye and B. Rushton. 1994. *A Survey of Water Quality of Wetlands-Treatment Stormwater Ponds*. Southwest Florida Water Management District. Brooksville, FL. 40 pp.

Reed, S. 1995. *Surface Flow Wetlands: A Technology Assessment*. USEPA. Office of Wastewater. Washington, DC.

## Article 66

Feature Article from *Watershed Protection Techniques*, 3(3): 695-706

# Stormwater Strategies for Arid and Semi-Arid Watersheds

Water supply and flood control have traditionally dominated watershed planning in arid and semi-arid climates. Until recent years, stormwater quality has simply not been much of a priority for water resource managers in the West. This situation is changing rapidly, as fast-growing communities are responding to both emerging water quality problems and new federal regulations. In particular, larger cities in the West have gradually been dealing with stormwater quality to meet the requirements of the first phase of EPA's municipal stormwater National Pollutant Discharge Elimination System (NPDES) program. Thousands more smaller communities will need to develop stormwater quality programs to meet the second phase of this national stormwater regulatory program.

At first glance, it seems ludicrous to consider managing the quality of stormwater in arid regions where storms are such a rare and generally welcome event—sort of like selling combs at a bald convention. The urban water resources of the southwest, however, are strongly influenced by stormwater runoff and by the watershed development that increases it. Indeed, the flow of many urban streams in the southwest is generated almost entirely by human activity: by urban storm

flow, irrigation return flow and wastewater effluent. Thus, the quality of both surface water and groundwater in urbanizing areas of arid and semi-arid regions of the southwest is strongly shaped by urbanization.

For purposes of this article, arid watersheds are defined as those that receive less than 15 inches of rain each year. Semi-arid watersheds get between 15 and 35 inches of rainfall, and have a distinct dry season where evaporation greatly exceeds rainfall. In contrast, humid watersheds are defined as those that get at least 35 inches of rain each year, and often much more. There are many arid and semi-arid watersheds, most of which are located in fast growing regions of the western United States (Figure 1). Low annual rainfall, extensive droughts, high intensity storms and high evaporation rates are characteristic of these watersheds, and present many challenges to the stormwater manager. [Note: in some arid and semi-arid watersheds, most precipitation falls as snow and evaporation rates are much lower. These watersheds are found in portions of Alaska and at higher elevations of the Rocky Mountains and Sierra Nevada. Guidance on stormwater strategies for these dry but cold watersheds can be found in Caraco and Claytor (1997)].

Figure 1: Distribution of Rainfall in the United States (USDOC, 1975)

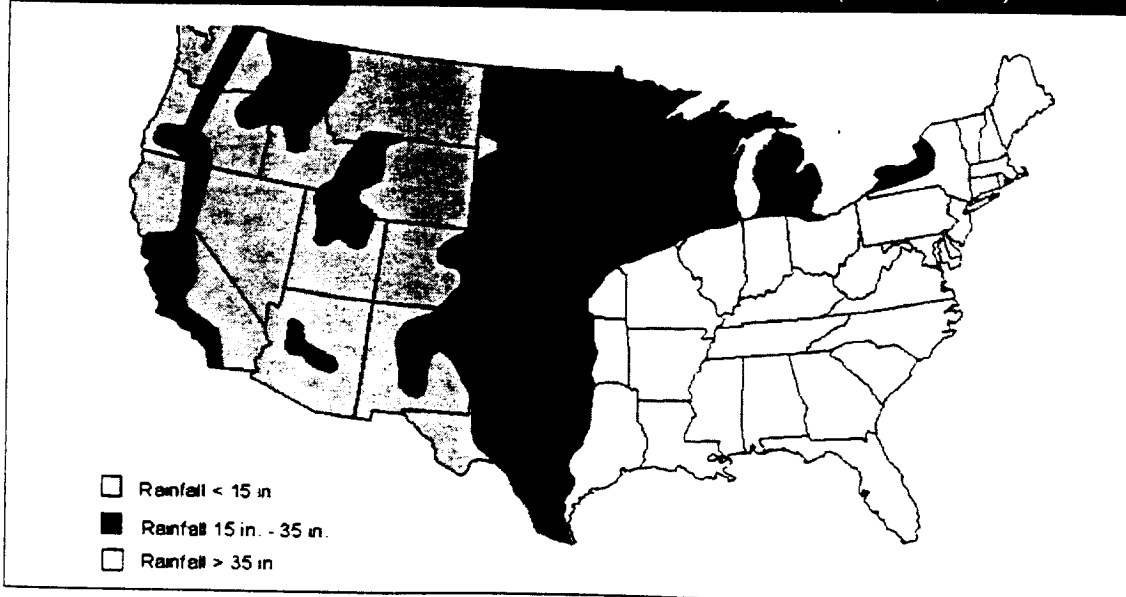

**Table 1: The West Is Different - Key Considerations in Arid and Semi-Arid Watersheds**

Aquatic resources and management objectives are fundamentally different.

Rainfall depths are much lower.

Evaporation rates are much higher.

Pollutant concentrations in stormwater are much greater.

Vegetative cover is sparse in the watershed.

Sediment movement is great.

Dry weather flow is rare, unless return flows are present.

This article reviews strategies for managing stormwater in regions of scarce water based on an extensive survey of 30 stormwater managers from arid and semi-arid regions. Next, the article explores how source control, better site design and stormwater practices can be adapted to meet the demanding conditions posed by arid and semi-arid climates. It begins by examining the environmental factors that make stormwater management in arid and semi-arid watersheds so unique and challenging. As a consequence, stormwater strategies for the west are often fundamentally different from

those originally developed for more humid regions. Some of these differences are explored in the next section and are outlined in Table 1.

*Aquatic Resources and Management Objectives Are Fundamentally Different*

The rivers of arid regions are dramatically different from their humid counterparts. Some idea of these differences can be seen by comparing the dynamics of an arid river to a humid one (see below). The differences are even more profound for the smaller urban streams in arid watersheds. In fact, it is probably appropriate to refer to them as gullies or arroyos rather than streams, since they rarely have a perennial flow of water. Many of the physical, chemical and biological indicators used to define stream quality in humid watersheds simply do not apply to the ephemeral washes and arroyos that comprise the bulk of the drainage network of arid watersheds. Without such indicators, it is difficult to define the qualities that merit protection in ephemeral streams. Clearly, the goals and purposes of stream protection need to be reinterpreted for ephemeral stream channels, and cannot be imported from humid regions.

In humid watersheds, the first objective of stormwater management is the protection of perennial streams, with goals such as maintaining pre-development flow rates, habitat conditions, water quality and biological diversity. In contrast, the objectives for stormwater management in most arid watersheds are ultimately

**An Arid River Runs Through It**

Consider, for a moment, the characteristics of the South Platte River as it runs through Denver, Colorado, as chronicled by Harris *et al.* (1997). Flow in the South Platte River is extremely variable with a few thunderstorms and the spring snow melt causing a half dozen dramatic peaks in discharge. Normally, however, the river flows quite low, falling below the average daily flow level some 354 days a year. Much of the flow in the South Platte has been spoken for: it has been estimated that river water is used and returned back to the river from three to seven times before it leaves the state (primarily due to upstream water appropriations for irrigation). Most of the time, the river's flow is sustained by municipal wastewater effluent flows, which contribute about 90% of the river's daily flow during most of the year. Indeed, without wastewater and irrigation flows, the river would frequently run dry (as it had prior to settlement). The river continues to strongly interact with groundwater, and much of the flow moves underground. The South Platte is very warm, with summer surface water temperatures exceeding 30 degrees Celsius (and fluctuating by as much as 15 degrees each day).

From a water quality standpoint, the South Platte frequently suffers from oxygen depletion, and has high concentrations of dissolved salts and nitrogen. Prior to settlement, the South Platte River was not believed to have riparian forest corridors, but in recent years, introduced species have become well established along many parts of the river. The quality of river habitat is generally regarded as poor, due to low flows, sandy, shifting substrates, and a lack of channel structure and woody debris. The river's channel continually changes in response to extreme variations in both flow and sediment supply. These extremely variable conditions are not conducive to a diverse aquatic habitat for aquatic insects or fish. For example, fewer than a dozen fish species inhabit the South Platte River, as compared to 30 or more that might be found in a humid region.



Table 2: Rainfall Statistics for Eight U.S. Cities (all units in inches)  
(NOAA, 1997)

City	Rainfall Statistics					
	Annual Rainfall	Days of Rain per Year	90% Rainfall Event	Annual Evaporation Rate	Two Year, 24 Hour Storm	Ten Year, 24 Hour Storm
Washington, DC	38	67	1.2	48	3.2	5.2
Dallas, TX	35	32	1.1	66	4.0	6.5
Austin, TX	33	49	1.4	80	4.1	7.5
Denver, CO	15	37	0.7	60	1.2	2.5
Los Angeles, CA	12	22	1.3	60	2.5	4.0
Boise, ID	11	48	0.5	53	1.2	1.8
Phoenix, AZ	7.7	29	0.8	82	1.4	2.4
Las Vegas, NV	4	10	0.7	120	1.0	2.0

driven either by flood control or the quality of a distant receiving water, such as a reservoir, estuary, ocean, or an underground aquifer.

Witness some of the recent water quality problems in arid and semi-arid watersheds for which stormwater is suspected to be primarily responsible: beach closures along the Southern California coast, trash and floatables washed into marinas in Santa Monica, nutrient enrichment in recreational reservoirs like Cherry Creek Reservoir in Denver and Town Lake in Austin, trace metals violations in the estuarine waters of San Francisco Bay, or concerns about the quality and quantity of groundwater recharge in aquifers of San Antonio. More local stormwater concerns include preventing the loss of capacity in irrigation channels or storage reservoirs caused by sedimentation.

Groundwater is particularly valued in arid and semi-arid watersheds. Many fast-growing Western communities are highly reliant on groundwater resources, and it is becoming a limiting factor for some. On a national basis, groundwater provides 39% of the public water supply. In the arid and semi-arid southwest, however, groundwater sources comprise 55% of the water supply (Maddock and Hines, 1995). Consequently, these communities have a strong interest in both the recharge and protection of groundwater on which they depend.

#### *Rainfall Depths Are Much Smaller*

Table 2 compares a series of rainfall statistics for eight arid, semi-arid and humid cities, and documents the fact that it rarely rains in arid watersheds. For example, in the fast growing Las Vegas, Nevada region,

rainfalls greater than a tenth of an inch occur, on average, less than 10 days a year. Not only does rain seldom fall, not much falls when it does. In arid watersheds, 90% of all rainfall events in a given year are usually less than 0.50 to 0.80 inches, compared to 1.0 to 1.5 inches in humid watersheds.

Consequently, if a "90% rule" is used in arid regions, the water quality storm is roughly half that of most semi-arid and humid watersheds, which greatly reduces the size, land consumption and cost of stormwater treatment practices that need to be built. In many cases, the entire water quality storm can be disposed of on-site through better site design, without the need for structural practices. It should be noted that there are some significant exceptions to this rule. Los Angeles, for example, experiences higher rainfall depths due to intense coastal storms in the winter, especially in el Nino years.

While intense storms cause the flash flooding that is so characteristic of the west, it is also important to keep in mind that the depth of rainfall in these storms is smaller than that of semi-arid and humid watersheds (Table 2). For example, the rainfall depth associated with the two-year 24-hour storm in most arid watersheds ranges from 1.0 to 1.4 inches, which is roughly equal to the typical water quality storm for a humid watershed. Similarly, the rainfall depth for the 10-year 24-hour storm in most arid watersheds ranges from two to three inches, which is roughly equivalent to the depth of a two-year storm in a semi-arid or humid watershed. Consequently, stormwater managers in arid regions can fully treat the quality and quantity of stormwater with about a third to

half of the storage needed in humid or semi-arid watersheds, with all other factors being equal.

Even though the rainfall depths in arid watersheds are lower, watershed development can greatly increase peak discharge rates during rare flood events. For example, Guay (1996) examined how development changed the frequency of floods in arid watersheds around Riverside, California. Over two decades, impervious cover increased from 9% to 22% in these fast-growing watersheds. As a direct result, Guay determined that peak flow rate at gauged stations for the two-year storm event had climbed by more than 100%, and that the average annual stormwater runoff volume had climbed by 115% to 130% over the same time span.

#### *Evaporation Rates are Greater*

High evaporation rates are a great challenge in arid and semi-arid watersheds. Low rainfall combined with high evaporation usually means that stored water will be lost water. In Las Vegas, for example, annual rainfall is a scant four inches, while pan evaporation exceeds 10 feet (See Table 2). Consequently, it is virtually impossible to maintain a pond or wetland in an arid watershed without a supplemental source of water (see Saunders and Gilroy, 1997; article 74). Evaporation also greatly exceeds rainfall for many months of the year in semi-arid

watersheds, and requires special pond design techniques.

#### *Pollutant Concentrations in Stormwater Are Often Higher*

The pollutant concentration of stormwater runoff from arid watersheds tends to be higher than that of humid watersheds. This is evident in Table 3, which compares event mean concentrations (EMCs) from five arid or semi-arid cities to the national average for several common stormwater pollutants. As can be seen, the concentration of suspended sediment, phosphorus, nitrogen, carbon and trace metals in stormwater runoff from arid and semi-arid watersheds consistently exceeds the national average, which is heavily biased toward humid watersheds. In addition, bacteria levels are often an order of magnitude higher in arid regions (Chang, 1999).

The higher pollutant concentrations in arid watersheds can be explained by several factors. First, since rain events are so rare, pollutants have more time to build up on impervious surfaces compared to humid regions. Second, pervious areas produce high sediment and organic carbon concentrations because the sparse vegetative cover does little to prevent soil erosion in uplands and along channels when it does rain. The

**Table 3: Stormwater Pollutant Event Mean Concentrations in Arid and Semi-Arid Regions (Units: mg/l, except for metals which are in ug/l)**

Pollutant	National	Phoenix, AZ	Boise, Idaho	Denver, Colorado	San Jose, California	Dallas, Texas
Source	(1)	(2)	(3)	(4)	(5)	(6)
Rainfall		7.1 inches	12 inches	13 inches	14 inches	28 inches
No. of Samples	2-3000	40	15	35	67	32
TSS	78.4	227	116 *	384	258	663
BOD	14.1	109	89	nd	12.3	12
COD	52.8	239	261	227	nd	106
Total N	2.39	3.26	4.13	4.80	nd	2.70
Total P	0.32	0.41	0.75	0.80	0.83 #	0.78
Soluble P	0.13	0.17	0.47	nd	nd	nd
Copper	14	47	34	60	58	40
Lead	68	72	46	250	105	330
Zinc	162	204	342	350	500	540

References: (1) Smullen and Cave, 1998, (2) Lopes *et al.*, 1995 (3) Kjellstrom, 1995 (computed) (4) DRCOG, 1983, (5) WCC, 1992 (computed) (6) Brush *et al.*, 1995.

Notes: nd= no data, # = small sample size \* = outfall pipe samples

strong effect of upland and channel erosion can be detected when stormwater samples are taken from channels, but are less pronounced in stormwater outfall pipes.

#### *Vegetative Cover Is Sparse in the Watershed*

Native vegetative cover is relatively sparse in arid and semi-arid watersheds, and offers little protection against soil erosion. Irrigation is required to establish dense and vigorous cover, which may not be sensible or economical given scarce water resources. In addition, high flows released from storm drains frequently accelerate downstream erosion since channels are also sparsely vegetated. Finally, many stormwater practices require dense vegetative cover to perform properly (e.g., grass swales are often not practical in arid watersheds, given the difficulty of establishing and maintaining turf).

#### *Sediment Movement Is Greater*

Stream channels in arid and semi-arid watersheds move a lot of sediment when they flow. For example, Trimble (1997) found that stream channel erosion supplied more than two thirds of the annual sediment yield of an urban San Diego Creek. He concluded that the higher flows due to watershed urbanization had greatly accelerated the erosion of arroyos, over and above the increases caused by grazing, climate and riparian management. Channel erosion can be particularly severe along road ditches that experience higher stormwater flows, which not only increases sediment erosion but also creates chronic ditch maintenance problems.

#### *Dry Weather Flows Are Rare, Unless Supplemented by Return Water*

Most small streams in arid watersheds are gullies or arroyos that only flow during and shortly after infrequent storm events. As streams urbanize, however, dry weather flow can actually increase. Human sources of dry weather flow include return flows from lawn and landscape watering, car washing, and surface discharges of treated wastewater. For example, Mizell and French (1995) found that excess water from residential and commercial landscape irrigation and construction site dewatering greatly increased rate and duration of dry weather flow in a Las Vegas Creek, and was sufficiently reliable to be the primary irrigation source for a downstream golf course.

#### **Stormwater Strategies for Arid and Semi-Arid Watersheds**

Watershed managers need to carefully choose stormwater practices that can meet the demanding climatic conditions and water resource objectives of arid and semi-arid watersheds. Communities can employ three broad strategies: aggressive source control,

better site design, and application of "western" stormwater practices. Some of the key trends in each of these areas are described below.

#### **Aggressive Source Control**

The term "source control" encompasses a series of practices to prevent pollutants from getting into the storm drain system in the first place. These practices include pollution prevention, street sweeping, and more frequent storm drain inlet clean-outs. Each practice acts to reduce the accumulation of pollutants on impervious surfaces or within the storm drain system during dry weather, thereby reducing the supply of pollutants that can wash off when it rains.

*Pollution prevention.* Pollution prevention seeks to change behaviors at residential, commercial and industrial sites to reduce exposure of pollutants to rainfall. Almost all arid stormwater managers consider pollution prevention measures to be an integral element of their stormwater management program, on par with the use of structural stormwater practices (CWP, 1997). And certainly, many western communities have pioneered innovative pollution prevention programs. These programs focus on educating homeowners and businesses on how they can reduce or prevent pollutants from entering the storm drain system when it's not raining.

In recent years, western communities have been targeting their educational message to more specific groups and populations. For example, Los Angeles County has identified seven priority categories for intensive employee training in industrial pollution prevention—auto scrap yards, auto repair, metal fabrication, motor freight, chemical manufacturing, car dealers, and gas stations—on the basis of their hotspot potential and their numerical dominance (Swammikannu, 1998). In the Santa Clara Valley of California, the three key priorities for intensive commercial pollution prevention training are car repair, construction, and landscaping services. Targeting is also used to reach homeowners with specific water conservation, car washing, fertilization and pesticide messages.

*Street sweeping.* Street sweeping seeks to remove the buildup of pollutants that have been deposited along the street or curb, using vacuum assisted sweeper trucks. While researchers continue to debate whether street sweepers can achieve optimal performance under real-world street conditions, most concede that street sweeping should be more effective in areas that have distinct wet and dry seasons (CDM, 1993), which is a defining characteristic of arid and semi-arid watersheds.

*Storm drain inlet clean-outs.* One of the last lines of defense to prevent pollutants from entering the storm drain system is to remove them in the storm drain inlet. Mineart and Singh (1994) reported that monthly or even quarterly clean-outs of sediment in storm drain inlets



could reduce stormwater pollutant loads to the San Francisco Bay by five to 10%. Currently, few communities clean out their storm drain inlets more than once a year, but a more aggressive effort to clean out storm drains prior to the onset of the wet season could be a viable strategy in some communities.

### Better Site Design

Better site design clearly presents great opportunities to reduce impervious cover and stormwater impacts in the west, but it has not been widely implemented to date. Indeed, the "California" development style, with its wide streets, massive driveways, and huge cul-de-sacs has been copied in many Western communities and arguably produces more impervious cover per home or business than any other part of the country (Figure 2). While the popularity of the California development style reflects the importance of the car in shaping communities, it is also a strong reaction against the arid and semi-arid landscape. The brown landscape is not green or pastoral, and many residents consider concrete and turf to be a more pleasing and functional land cover than the dirt and shrubs they replace.

While better site design techniques are extensively profiled in articles 45 to 48, it is worth discussing how these techniques can be adapted for western developments. A key adaptation is to incorporate the concept of "stormwater harvesting" into residential and commercial development design (COT, 1996). Water harvesting is an ancient concept that involves capturing runoff from rooftops and other impervious surfaces and using it for drinking water or to irrigate plants (e.g., the cistern). In a more modern version, rooftop runoff is spread over

landscaping areas or the yard, with the goal of completely disposing of runoff on the property for storm events up to the two-year storm (which ranges from one to two inches in most arid and semi-arid climates). For example, the City of Tucson recommends 55 gallons of storage per 300 to 600 square feet of rooftop for residential bioretention areas (COT, 1996). In higher density settings, it may be more practical to store water in a rain barrel or cistern for irrigation use during dry periods.

When water harvesting is aggressively pursued, stormwater runoff is produced only from the impervious surfaces that are directly connected to the roadway system. Denver has utilized a similar strategy program to disconnect impervious areas and reduce the amount of stormwater pollution (DUDFC, 1992). A useful guide on these techniques has also been produced for the San Francisco Bay area (BASMAA, 1997). Water harvesting may prove to be another useful stormwater retrofitting strategy, particularly in regions where water conservation is also a high priority.

Better site design techniques also need to be adapted for fire safety in Western communities adjacent to chaparral vegetation that are prone to periodic wildfires. In some case, vegetation setbacks must be increased in these habitats to protect developments from dangerous wildfires (CWP, 1998).

### Developing Western Stormwater Practices

Given the many challenges and constraints that arid and semi-arid watersheds impose, managers need to adapt and modify stormwater practices that were originally developed in humid watersheds. In our stormwater managers survey, four recurring principles emerged on how to design "Western" stormwater practices:

1. *Carefully select and adapt stormwater practices for arid watersheds.*
2. *Minimize irrigation needs for stormwater practices.*
3. *Protect groundwater resources and encourage recharge.*
4. *Reduce downstream channel erosion and protect from upland sediment.*

1. *Carefully select and adapt stormwater practices for arid watersheds.*

Some stormwater practices developed in humid watersheds are simply not applicable to arid watersheds, and most others require major modifications to be effective (Table 4). Even in semi-arid watersheds, design criteria for most stormwater practices need to be revised to meet performance and maintenance objectives. The following section highlights some of

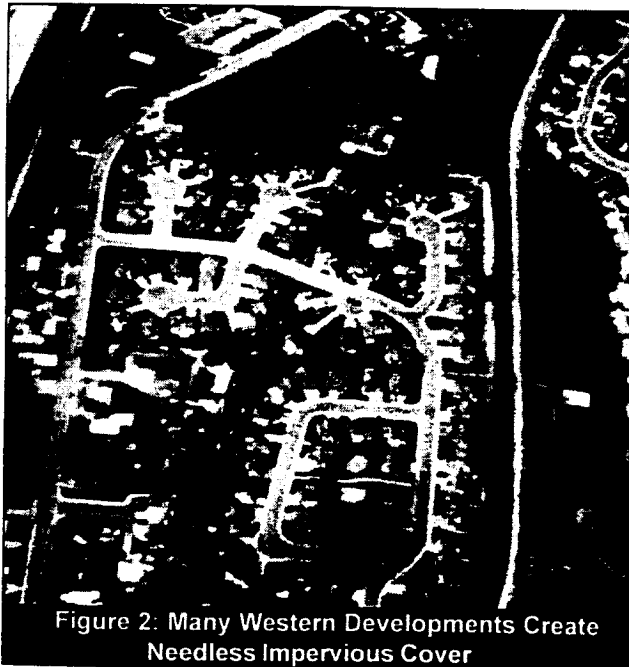

Figure 2: Many Western Developments Create Needless Impervious Cover



the major design and performance differences to consider for major stormwater practices.

*Extended Detention (ED) Dry Ponds.* The most widely utilized stormwater practices in arid and semi-arid watersheds were dry ponds, according to the Center's survey (Figure 3). Most were designed exclusively for flood control, but can be easily modified to provide greater treatment of stormwater quality. While dry ED ponds are not noted for their ability to remove

soluble pollutants, they are reasonably effective in removing sediment and other pollutants associated with particulate matter (see article 64). In addition, ED ponds can play a key role in downstream channel protection, if the appropriate design storm is selected, and adequate upstream pretreatment is incorporated. Dry extended detention is the most feasible pond option in arid watersheds, since they do not require a permanent pool of water.

**Table 4. Design Modifications for Stormwater Practices in Arid and Semi-Arid Watersheds**

<b>Stormwater Practice</b>	<b>Arid Watersheds</b>	<b>Semi-Arid Watersheds</b>
<b>ED Dry Ponds</b>	<b>PREFERRED</b> <ul style="list-style-type: none"> <li>multiple storm ED</li> <li>stable pilot channels</li> <li>"dry" forebay</li> </ul>	<b>ACCEPTABLE</b> <ul style="list-style-type: none"> <li>dry or wet forebay needed</li> </ul>
<b>Wet Ponds</b>	<b>NOT RECOMMENDED</b> <ul style="list-style-type: none"> <li>evaporation rates are too high to maintain a normal pool</li> <li>without extensive use of scarce water</li> </ul>	<b>LIMITED USE</b> <ul style="list-style-type: none"> <li>liners to prevent water loss</li> <li>require water balance analysis design for a variable rather than permanent normal pool</li> <li>use water sources such as AC condensate for pool</li> <li>aeration unit to prevent stagnation</li> </ul>
<b>Stormwater Wetlands</b>	<b>NOT RECOMMENDED</b> <ul style="list-style-type: none"> <li>evaporation rates too great to maintain wetland plants</li> </ul>	<b>LIMITED USE</b> <ul style="list-style-type: none"> <li>require supplemental water</li> <li>submerged gravel wetlands can help reduce water loss</li> </ul>
<b>Sand Filters</b>	<b>PREFERRED</b> <ul style="list-style-type: none"> <li>requires greater pretreatment</li> <li>exclude pervious areas</li> </ul>	<b>PREFERRED</b> <ul style="list-style-type: none"> <li>refer to COA, 1994 for design criteria</li> </ul>
<b>Bioretention</b>	<b>MAJOR MODIFICATION</b> <ul style="list-style-type: none"> <li>no irrigation</li> <li>better pretreatment</li> <li>treat no pervious area</li> <li>xeriscape plants or no plants</li> <li>replace mulch with gravel</li> </ul>	<b>MAJOR MODIFICATION</b> <ul style="list-style-type: none"> <li>use runoff to supplement irrigation</li> <li>use xeriscaping plants</li> <li>avoid trees</li> <li>replace mulch with gravel</li> </ul>
<b>Rooftop Infiltration</b>	<b>PREFERRED</b> <ul style="list-style-type: none"> <li>dry well design for recharge of residential rooftops</li> </ul>	<b>PREFERRED</b> <ul style="list-style-type: none"> <li>recharge rooftop runoff on-site unless the land use is a hotspot</li> </ul>
<b>Infiltration</b>	<b>MAJOR MODIFICATION</b> <ul style="list-style-type: none"> <li>no recharge for hotspot land uses</li> <li>treat no pervious area</li> <li>multiple pretreatment</li> <li>soil limitations</li> </ul>	<b>MAJOR MODIFICATION</b> <ul style="list-style-type: none"> <li>no recharge for hotspot land uses</li> <li>treat no pervious area</li> <li>multiple pretreatment</li> </ul>
<b>Swales</b>	<b>NOT RECOMMENDED</b> <ul style="list-style-type: none"> <li>not recommended for pollutant removal, but rock berms and grade control needed for open channels to prevent channel erosion</li> </ul>	<b>LIMITED USE</b> <ul style="list-style-type: none"> <li>limited use unless irrigated</li> <li>rock berms and grade control essential to prevent erosion in open channels</li> </ul>



*Wet Ponds.* Wet ponds are often impractical in arid watersheds since it is not possible to maintain a permanent pool without supplemental water, and the ponds become stagnant between storms. On the other hand, wet ponds are feasible in some semi-arid watersheds when carefully designed. Performance monitoring studies have demonstrated that wet ponds exhibit greater pollutant removal than other stormwater practices in Austin, Texas, at a lower cost per volume treated (Glick, 1998, and article 75).

In arid and semi-arid climates, wet ponds can require supplemental water to maintain a stable pool elevation. Saunders and Gilroy (1997) reported that 2.6 acre-feet per year of supplemental water were needed to maintain a permanent pool of only 0.29 acre-feet. Generally speaking, stormwater designers working in semi-arid watersheds should design for a variable pool level that can have as much as a three-foot draw down during the dry season. The use of wetland plants along the pond's shoreline margin can help conceal the drop in water level, but managers will need to reconcile themselves to chronic algal blooms, high densities of aquatic plants and occasional odor problems. The City of Austin has prepared useful wet pond design criteria to address these issues (COA, 1997).

*Stormwater Wetlands.* Few communities recommend the use of stormwater wetlands in either arid or semi-arid watersheds. Once again, the draw down rates caused by evaporation make it difficult to impossible to maintain

standing water that can sustain emergent wetland plants, unless copious subsidies of supplemental water are supplied. One interesting exception was a gravel-based wetland that treated parking lot runoff in Phoenix, Arizona (Wass and Fox, 1995). While the wetland did require some supplemental water, evaporation was reduced by the overlying gravel bed, and the wetland achieved relatively high removal rates of oil and grease.

*Sand Filters.* Sand filters continue to be one of the most common practices used to treat the quality of stormwater in both arid and semi-arid watersheds. Sand filters require no supplemental water and can be used with almost any soil type (Claytor and Schueler, 1997). Still, the basic sand filter design continues to evolve to counter the tough design conditions found in these regions.

For example, Urbonas (1997) evaluated sand filter performance in Denver, Colorado, and concluded that designs need to be modified to account for the greater sediment buildup in arid regions (see article 108). Urbonas found that the test sand filter quickly became clogged with sediment after just a few storms, and recommended that sand filters include a more frequent sediment clean out regime, an increase in the filter bed size, and upstream detention to provide greater sediment pretreatment. Some additional research on the performance and longevity of sand filters in the semi-arid climate of Austin, Texas can be found in article 106.

Figure 3: Stormwater Practice Preferences in Arid Climates (CWP, 1997)

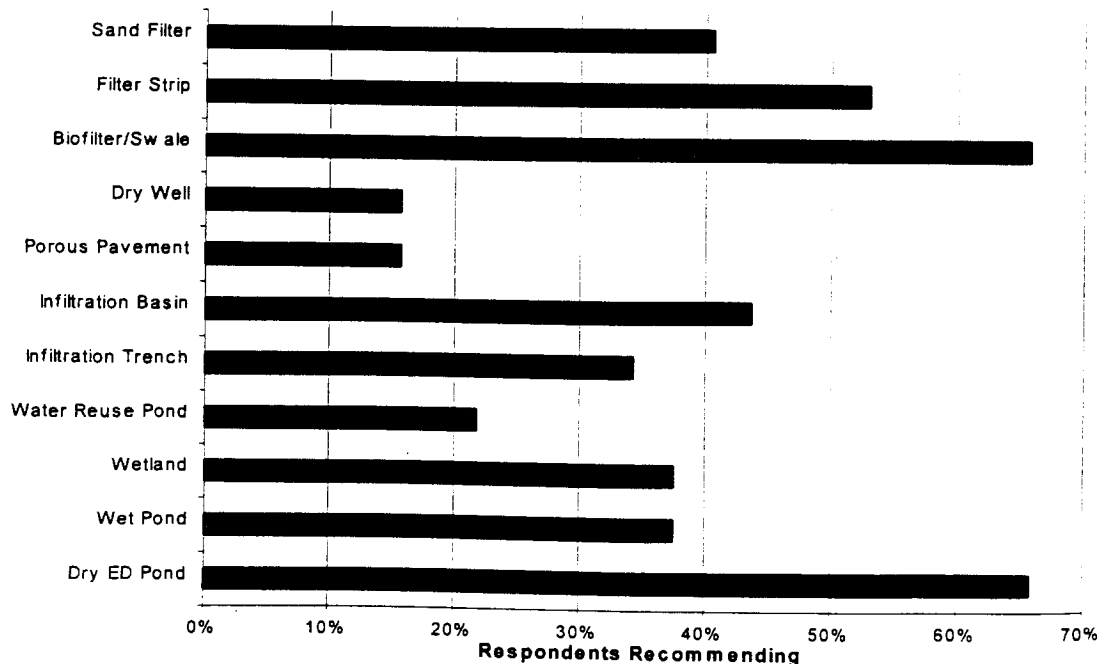

*Bioretention.* The use of bioretention as a stormwater treatment practice is not very common in many Western communities at the present time. Clearly, this practice will require extensive modification to work in arid watersheds. This might entail xeriscape plantings, use of gravel instead of mulch as ground cover, and better pretreatment. Sprinkler irrigation of bioretention areas should be avoided.

*Infiltration Practices.* While a number of communities allowed the use of infiltration in arid and semi-arid watersheds, few encouraged its use. Two concerns were frequently cited as the reason for lack of enthusiasm for structural infiltration. The first concern was that infiltration practices are too susceptible to rapid clogging, given the high erosion rates that are customary in arid and semi-arid watersheds. The second concern was that untreated stormwater could potentially contaminate the aquifers that are used for groundwater recharge.

*Swales.* The use of grass swales for stormwater treatment was rarely reported for arid watersheds, but was much more common in semi-arid conditions. Grass swales are widely used as a stormwater practice in residential developments in Boise, Idaho, but the dense turf can only be maintained in these arid conditions through the use of sprinkler irrigation systems. The pollutant removal performance of swales in arid and semi-arid watersheds appears to be mixed. Poor to negative pollutant removal performance was reported in a Denver swale that was not irrigated (Urbonas, 1999 -personal communication). In the semi-arid climate of Austin, Texas, Barret *et al.* (1998) reported excellent pollutant removal in two highway swales that were vegetated but not irrigated (Table 5). Similar performance was also noted in a non-irrigated swale monitored by the City of Austin (COA, 1997).

## 2. Minimize irrigation needs for stormwater practices

In arid climates, all sources of water, including stormwater runoff, need to be viewed as a resource. It seems senseless, therefore, to irrigate a practice with 50 inches of scarce water a year so that it can be ready to treat the stormwater runoff produced from 10 inches of rain a year. Still, irrigation of stormwater practices was very common in our survey of arid and semi-arid stormwater managers; in fact, 65% reported that irrigation was commonly used to establish and maintain vegetated cover for most stormwater practices.

Irrigation should be limited to practices that meet some other landscaping or recreational need in a community and would be irrigated anyway, such as landscaping islands in commercial areas and road rights of way. Irrigation may also be a useful strategy for dry ED ponds that are designed for dual use, such as facilities that serve as a ballfield or community park during the dry season. Even when irrigation is used, practices should be designed to "harvest" stormwater, and therefore reduce irrigation needs. Landscapers should also consider planting native drought resistant plant material to reduce water consumption.

## 3. Protect groundwater resources and encourage recharge.

In many arid communities, protection of groundwater resources is the primary driving force behind stormwater treatment. Ironically, early efforts to use stormwater to recharge groundwater have resulted in some groundwater quality concerns. In Arizona, for example, stormwater was traditionally injected into 10 to 40 foot deep dry wells to provide for groundwater recharge. Concerns were raised that deep injection

Table 5. Performance of Vegetated Swales in Semi-arid Climates  
(Barret *et al.*, 1998, and COA, 1998)

	Highway 183 Median	Walnut Creek	City of Austin Swale
Parameter	Mass Load Reduction (%)		
TSS	89	87	68
COD	68	69	33
TP	55	45	43
TKN	46	54	32
Nitrate	59	36	(-2)
Zinc	93	79	ns
Lead	52	31	ns

ns = not sampled. Fecal coliform and fecal strep removals were negative at the 183 and Walnut Creek sites.



could increase the risk of localized groundwater contamination. since untreated stormwater can be a source of pollutants, particularly if the proposed land use is classified as a stormwater hotspot.

Wilson *et al.* (1990) evaluated the risk of dry well stormwater contamination in Pima County, Arizona, and determined that dry wells had elevated pollutant concentrations in local groundwater. The build up of pollutant levels that had occurred over several decades tended to be localized, and did not exceed drinking water standards. Still, it is important to keep in mind that dry wells and other injection recharge methods should only be used to infiltrate relatively "clean" runoff, such as residential roofs. Other surface infiltration practices, such as trenches and basins, can also potentially contaminate groundwater unless they are carefully designed for runoff pretreatment, provide a significant soil separation distance to the aquifer, and are not used on "hot spot" runoff sites.

#### 4. Design to reduce channel erosion

Above all, a western stormwater practice must be designed to reduce *downstream* erosion in ephemeral channels, while at the same time protecting itself from sediment deposition from *upstream* sources. This is a daunting challenge for any engineer, but the following ideas can help.

With respect to *downstream channel erosion*, designers will need to clamp down on the storm events that produce active erosion in channels. This might entail the design of ponds or basins that can provide 12 hours of extended detention for the one-year return interval storm event (which is usually no more than an inch or two in most arid and semi-arid watersheds). Local geomorphic assessment will probably be needed to set channel protection criteria, and these hydraulic studies are probably the most critical research priority in both arid and semi-arid watersheds today. Without ED channel protection, designers must rely on clumsy and localized engineering techniques to protect ditches and channels from eroding, such as grade control, rock berms, rip-rap, or even concrete lined channels. Bioengineering options to stabilize downstream channels in arid watersheds are limited, and often require erosion control blankets to retain moisture and seeds, as well as extensive irrigation.

*Upstream erosion* quickly reduces the capacity of any stormwater practice in an arid or semi-arid watershed, due to sparse vegetation cover and erosion from upstream gullies, ditches, or channels. Designers have several options to deal with this problem. The most effective option is to locate the practice so that it can only accept runoff from impervious areas, particularly for infiltration, sand filters and bioretention. Even then, the practice will still be subject to sediment transported by the wind.

All stormwater practices in arid and semi-arid watersheds require greater pretreatment than in humid water-

sheds. Seventy percent of the arid stormwater managers surveyed reported that sediment clogging and deposition problems were a major design and maintenance problem for nearly all of their stormwater practices.

Even though not all upstream erosion can be prevented, designers can compensate for sediment buildup within the stormwater practice itself. Pretreatment and over-sizing can prevent the loss of storage or clogging associated with sediment deposition. As noted in article 106, rock berms or vertical gravel filters are ideally suited as a pretreatment device.

Most stormwater managers surveyed indicated that sediment clean-outs need to be more frequent for stormwater practices in arid and semi-arid watersheds, with removal after major storms and at a minimum, once a year. Stormwater managers also consistently emphasized the need for better upland erosion control during construction. A full 65% of the managers reported that upstream erosion and sediment control were a major emphasis of their stormwater plan review.

#### Summary

It is clear that stormwater managers in arid and semi-arid climates cannot simply import the stormwater programs and practices that were originally developed for humid watersheds. Instead, they will need to develop stormwater solutions that combine aggressive source control, better site design and stormwater practices in a distinctly western context. Regulators, in turn, need to recognize that Western climates, terrain and water resource objectives are different, and be flexible and willing to experiment with new approaches in municipal stormwater programs. Lastly, stormwater managers from arid and semi-arid watersheds must work more closely together to share experiences about the stormwater solutions that work and fail. It is only through this dialogue that Western communities can gradually engineer stormwater practices that are rugged enough to withstand the demanding challenges of the arid and semi-arid west. - DSC

#### References

- Bay Area Stormwater management Agencies Association (BASMAA). 1997. *Starting at the Source: Residential Site Planning and Design Guidance Manual for Stormwater Quality Protection*. BASMAA. San Francisco, CA.
- Barret, M., and M. Keblin, P. Walsh, J. Malina and R. Charbeneau. 1998. *Evaluation of the Performance of Permanent Runoff Controls: Summary and Conclusions*. Center for Transportation Research. Texas Dept of Transportation. University of Texas. Austin, TX. 37 pp.
- Brush, S, M. Jennings, J. Young, and H. McCreath. 1995. *NPDES Monitoring- Dallas/Fort Worth Texas Area*. Pp. 115-143. In *Stormwater NPDES Monitoring Needs*. American Society of Civil Engineers.

- Camp Dresser and McKee (CDM), Larry Walker Associates, and Uribe and Associates, and Resources Planning Associates. 1993. *California Stormwater Best Management Practices Handbook*. Prepared For: California Water Quality Control Board. Sacramento, CA.
- Caraco, Deb and Rich Claytor. 1997. *BMP Supplement for Cold Climates*. U.S. Environmental Protection Agency. Center for Watershed Protection. Ellicott City, MD. 112 pp.
- Center for Watershed Protection (CWP). 1997. *Survey of Stormwater Managers in Arid and Semi-arid Climates*. Ellicott City, MD. Unpublished Data.
- Center for Watershed Protection (CWP). 1998. *Better Site Design: A Handbook for Changing Development Rules in Your Community*. Ellicott City, MD.
- Chang, G. 1999. Personal communication. City of Austin Drainage Utility. Austin, TX.
- City of Austin (COA). 1994. *Environmental Criteria Manual: Guidelines for BMP Design*. City of Austin Drainage Utility. Austin, TX.
- City of Austin (COA). 1997. "Wet Ponds." Section 1.6.6.c of *Environmental Criteria Manual*. Drainage Utility. City of Austin, TX.
- City of Tucson (COT). Stormwater Quality Program. 1996. *Water Harvesting Fact Sheets*. Tucson, AZ.
- Claytor, Rich and Tom Schueler. 1997. *Design of Stormwater Filtering Systems*. Prepared for: Chesapeake Research Consortium. Center for Watershed Protection. Ellicott City, MD.
- Denver Regional Council of Governments (DRCOG). 1983. *Urban Runoff Quality in the Denver Region*. Prepared for US EPA NURP Program. Denver, CO. 240 pp.
- Denver Urban Drainage and Flood Control District (DUDFCD). 1992. *Urban Storm Drainage Criteria Manual*. Volumes 1, 2 and 3. Denver, CO.
- Glick, R. and C. Chang and M. Barret. 1998. "Monitoring and Evaluation of Stormwater Quality Control basins." Proceedings: *Watershed Management: Moving from Theory to Implementation*. Water Environment Federation Specialty Conference. Denver, Co.
- Guay, J. 1996. *Effects of Increased Urbanization from 1970s to 1990s on Storm Runoff Characteristics in Perris Valley, California*. USGS Water Resources Investigations Report. 95-4273.
- Harris, T., J. Saunders, and W. Lewis. 1997. "Urban Rivers in Arid Environments— Unique Ecosystems." pp. 421-438 in *Effects of Watershed Development and Management of Aquatic Ecosystems*. L. Roesner, Editor. American Society of Civil Engineers. New York, NY.
- Kjelstrom, L. 1995. *Data for and Adjusted Regional Regression Models of Volume and Quality of Urban Stormwater Runoff in Boise and Garden City, Idaho, 1993-94*. United States Geological Survey Water Resources Investigations Report 95-4228.
- Lopes, T. K. Fossum, J. Phillips and J. Marical. 1995. *Statistical Summary of Selected Physical, Chemical, and Microbial Contaminants and Estimates of Constituent Loads in Urban Stormwater in Maricopa County, Arizona*. USGS Water Resources Investigations Report 94-4240.
- Maddock, T. and W. Hines. 1995. "Meeting Future Public Water Supply Needs: A Southwest Perspective." *Water Resources Bulletin*, 31(2): 317-329.
- Miner, P. and S. Singh. 1994. "The Value of More Frequent Cleanouts at Storm Drain Inlets." Technical Note 35, *Watershed Protection Techniques*. 1(3):129-130.
- Mizell, S. and R. French. 1995. "Beneficial Use of Dry Weather Flow in the Las Vegas Valley, Nevada." *Water Resources Bulletin*, 31(3): 447-461.
- National Oceanographic and Atmospheric Administration (NOAA). 1997. *NCDC Summary of the Day Weather Records*. Silver Spring, MD.
- Saunders and Gilroy. 1997. *Treatment of Nonpoint Source Pollution with Wetland/Aquatic Ecosystem Best Management Practices*. Texas Water Development Board. Lower Colorado River Authority. Austin, TX.
- Smullen, J. and K. Cave. 1998. *Updating the U.S. Nationwide Urban Runoff Quality Database*. pp 202-218 in Conference Proceedings. Third International Conference on Diffuse Pollution. International Association of Water Quality. Edinburgh, Scotland.
- Swamikannu, X. 1998. "An Integrated Strategy for Managing Urban Runoff Pollution in Los Angeles County." In *Stormwater Run*
- Trimble, S. 1997. "Contribution of Stream Channel Erosion to Sediment Yield from an Urbanizing Watershed." *Science*. 278:1442-1444.
- United States Department of Commerce (USDOC). 1975. *Weather atlas of the United States*. Gale research Company. Detroit, MI.
- Urbonas, B. 1997. "Field Evaluation of a Stormwater Filter." *Watershed Protection Techniques*. 2(4): 536-538.
- Urbonas, B. 1999. Personal communication. Denver Urban Drainage and Flood Control District. Denver, CO.
- Wass, R. and P. Fox. 1995. "Constructed Wetlands Enhances Stormwater Quality in Arizona." *Industrial Wastewater*, March/April: 43-46.
- Wilson, L. and M. Osborn, K. Olsen, S. Maida and L. Katz. 1990. *The Groundwater Recharge and Pollution Potential of Dry Wells in Pima County, Arizona*. Ground Water Management Research, Summer 1990.
- Woodward-Clyde Consultants, Inc. 1992. Annual monitoring report. Santa Clara Valley Nonpoint Source Pollution Control Program.

# Microbes and Urban Watersheds: Ways to Kill 'Em

**M**anaging microbes from urban watersheds can be a daunting task, as bacteria are usually present in high concentrations during storms, come from many different sources, and follow many complex pathways to reach receiving waters. In this article, we examine whether it is technically feasible to reduce microbes in urban stormwater to maintain drinking water, water contact recreation and shellfish consumption uses. The article begins with a discussion of the causes of bacteria mortality, and then reviews what is currently known about bacteria removal provided by stormwater treatment practices, stream buffers, and source controls. The major focus is on fecal coliform bacteria, as this indicator has been used in nearly all performance studies conducted to date.

The review concludes that current stormwater practices, stream buffers and source controls have a modest potential to reduce fecal coliform levels, but cannot reduce them far enough to meet water quality standards in most urban settings. It is also argued that current watershed practices have even less capability to remove protozoans in stormwater runoff, such as *Giardia* and *Cryptosporidium*. The last section examines several design improvements that might enhance the bacteria removal performance of watershed management practices.

## Sources of Bacteria Mortality

Most fecal coliform bacteria thrive in the digestive systems of warm-blooded animals, but do not fare well when exposed to the outside world. Over time, most fecal coliforms gradually "die-off." Key factors and practices that can be manipulated to increase bacteria die-off include the following:

- Sunlight (ultraviolet light)
- Sedimentation
- Sand filtration
- Soil filtration
- Chemical disinfection
- Growth inhibitors

The term "die-off," however, is not as final as it would appear. Often, researchers actually only measure the "disappearance" of bacteria from the water column. Bacteria and viruses settle from the water column to the bottom sediments. Given the warm, dark, moist and organic-rich conditions found in bottom sediments, many coliform bacteria can survive and even multiply in this environment. A number of researchers have documented this behavior in the sediments of storm drains, catch basins, ditches and channels. If these sediments are resuspended by turbulent stormwater flows, the bacteria can reappear in the water column.

Researchers and engineers have examined the "die-off" rates for many different microbes in fresh waters (Mancini, 1978). Bacteria die-off can be modeled as a first-order decay equation, using a  $k$  value of about 0.7 to 1.5 per day (Figure 1). In practical terms, "k" values in this range mean that about 90% of bacteria present will disappear from the water column within two to five days. The die-off rate is generally much faster in marine and estuarine waters than freshwater (Thoman and Mueller, 1987).

## Exposure to Sunlight

Bacteria are a lot like vampires in that they generally can't stand the light of day. Bacteria are killed when exposed to a very specific and narrow band of the light spectrum (254 nm—ultraviolet UV light). Consequently, exposure to sunlight is one of the most important factors causing bacteria die-off. Maximum die-off requires clear water, however, and the turbidity and organic matter

Figure 1: Effect of Different Die-off Rates ( $k$ ) on Bacteria Mortality (Hydroqual, Inc., 1996)

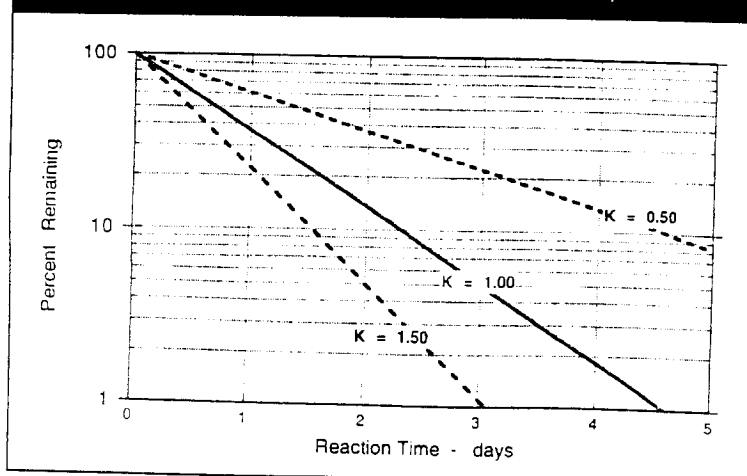

**Table 1: Comparison of Die-Off Rates and Treatment Effectiveness for Different Microbes**

Microbial Indicator	Light?	Settling?	Surface filtration?	Die off rates (k)	Ability to Multiply	Survival in sediments?
Total coliforms	Yes	Yes	Yes	1/day	Yes	Moderate
Fecal coliforms	Yes	Yes	Yes	0.7 - 1.0/day	Yes	Days
Fecal Streptococci	Yes	Yes	Yes	1/day	Low	Weeks
<i>Escherichia Coli</i>	Yes	Yes	Yes	1/day	Low	Months
<i>Salmonella spp.</i>	Yes	Yes	Yes	1.5/day	Yes	Weeks to months
<i>Pseudomonas aeruginosa</i>	Yes	Partial	Yes	?	Yes	Months
<i>Cryptosporidium spp.</i>	No	Partial	Partial	suspected to be weeks	No	Months
<i>Giardia spp.</i>	No	Partial	Partial	suspected to be weeks	No	Months

found in urban runoff can greatly interfere with the sunlight effect (Bank and Schemmel, 1990).

UV light has been utilized by water utilities to disinfect drinking water and wastewater effluent. In recent years, this technique has been used for end-of-pipe runoff treatment at combined sewer and stormwater outfalls in a few settings including Toronto, New York, and Florida (O'Shea and Field, 1992). These initial applications indicated that substantial stormwater treatment is needed to remove suspended solids before UV light is effective. Sophisticated telemetry and energy are also needed to calibrate the "dosage" of intensive UV light to the rapidly changing flow conditions in stormwater.

#### *Sedimentation*

Individual fecal coliform bacteria cells are very small particles (as small as a single micron in diameter), but they frequently adsorb to sediment particles or attach to other bacterial cells. Schillinger and Gannon (1982) reported that about 15 to 30% of fecal coliform cells present in stormwater are adsorbed to larger suspended particles, most of which were greater than 30 microns in diameter. Fecal coliform bacteria that do

adsorb to these larger particles can settle rapidly out of the water column (Schillinger and Gannon, 1982; Auer and Niehaus, 1993).

Bacteria that do not attach or adsorb to particles are much harder to settle. Schillinger and Gannon (1982) note that 50% of fecal coliform bacteria in stormwater suspensions were not attached. These cells are only one to two microns in diameter and effectively act like fine clay particles in terms of surface transport and settling characteristics (Coyné *et al.*, 1995). Such small particles have very slow settling velocities, and may remain in suspension for days or even weeks.

Auer and Niehaus (1993) computed a combined settling velocity for unattached and attached coliform bacterial cells in urban stormwater of about two to four feet per day, depending on the relative proportion of small and large bacteria "particles." Using this settling rate, about 90% of bacteria would settle out from a typical stormwater pond in about two days under ideal conditions. This finding is consistent with the one log bacteria removal consistently achieved in stabilization ponds utilized for wastewater treatment which typically yields a fecal coliform effluent of about 1,000 MPN per 100 ml (Godfrey, 1992).



### *Sand Filtration*

Sand filtration has traditionally been used by water utilities to ensure the purity of drinking water, after chemical pretreatment and sedimentation are employed. Coliform removal rates of 97 to 99.5% can be expected in a properly operated treatment plant (Viessman and Hammer, 1993), but drop to about 60% without prior chemical pretreatment.

Sand filtration has been adapted to treat storm water runoff (Clayton and Schueler, 1996), but it is important to recognize that stormwater sand filters are different in many ways from those used to treat drinking water. First, sand filters employed to treat drinking water use several layers of filter media to promote more consistent filtration (e.g., anthracite and garnet). Second, drinking water filters are designed to enable daily "back flushing" that drives trapped sediments and microbes backup through the filter bed and thereby prevents microbial breakthrough in the filter media. Lastly, drinking water filters employ chemical pretreatment to remove larger solids before they ever reach the filtration bed.

Most stormwater sand filters lack these characteristics—particularly the ability to back flush. This is worth noting, since individual bacterial cells are only a few microns in size and may not be fully strained out by passing through sand grains that are much larger in size (45 to 55 microns). Thus, since stormwater filters are not regularly back-flushed, it is likely that microbes and pollutants migrate through the filter bed over time. Consequently, most field studies of sand filters remove only 50 to 65% of carbon and bacteria, although solids removal can approach 90% (article 64).

### *Soil Filtration*

Bacteria can be effectively treated by filtering and straining water through the soil profile. Indeed, a home septic system relies on soil filtration. In this traditional method for onsite sewage disposal, wastewater is distributed through a subsurface drain field and allowed to percolate through the soil (after larger solids have been trapped in a septic tank). Soil filtration is similar to sand filtration, but can result in greater bacteria removal rates since the higher organic matter and clay content of most soils increases potential bacteria adsorption (Robertson and Edberg, 1997). When properly located, installed and maintained, septic systems can achieve virtually complete bacteria removal over a distance of 50 to 300 feet (but not necessarily complete removal of much smaller enteric viruses). A number of factors can cause soil filtration to fail (e.g., clogging, macropores, hydraulic overloading, thin soils, excessively permeable soils or bedrock fractures). In these cases, wastewater breaks out or through the soil profile with little or no treatment.

Several stormwater practices also utilize some degree of soil filtration to aid in pollutant removal. Examples include infiltration practices and bioretention

areas that divert runoff through the soil profile. To a lesser degree, grass swales allow for some soil filtration if runoff infiltrates into the channel during smaller storms. No data are available to assess the performance of stormwater practices that utilize soil filtration, but it is reasonable to assume that their bacteria removal rates are comparable to septic systems if the soil filter is deep enough.

### *Chemical Disinfection*

Bacteria can be rapidly killed through chemical disinfection. The most common approach is to add chlorine or related compounds to wastewater. While chlorine can be very effective in killing bacteria, it needs to be added at the right dosage. If too little chlorine is added, some bacteria will survive, particularly those adsorbed to solid particles (Field *et al.*, 1993). If too much chlorine is added, environmentally harmful chlorine residuals can be released downstream. Precise dosing is possible within the highly controlled conditions of a water supply or wastewater treatment plant, but is very difficult to attain when flow and turbidity are highly variable. Thus, chemical disinfection of stormwater has been largely restricted to combined sewer overflow abatement facilities and a few Canadian beach outfalls (O'Shea and Field, 1992).

### *Growth Inhibitors*

A series of factors can slow the growth of bacteria in surface waters and sediments. While these factors do not technically kill bacteria, they do slow their growth, reduce survival and increase predation. Major factors that can inhibit the growth of bacteria include colder water temperatures, low nutrient levels, low carbon supplies, low pH levels and moisture loss (Oliveri *et al.*, 1977). While it is difficult for a watershed manager to control these factors, they can sometimes be manipulated in the design of stormwater practices and open channels to achieve greater bacteria removal.

### *Sources of Protozoan Mortality*

Protozoans such as *Cryptosporidium* and *Giardia* appear to be harder to control than fecal coliform bacteria (Table 1). This is somewhat surprising given that cysts and oocysts can be five to 10 times larger than individual bacterial cells, and therefore should settle or filter more rapidly. The cysts and oocysts of these protozoans, however, are not affected by sunlight, and because of their persistence and durability they can last for many months in wet sediments (Bagley *et al.*, 1998). Soil filtration does appear to be a promising method, as protozoans are not very mobile in soils (Robertson and Edberg, 1997).

Sand filtration at drinking water plants has not been found to be fully effective in removing all cysts and oocysts according to Lechevalier and Norton (1995).



although it is not clear whether the cysts that pass through sand filters remain viable. (Indeed, a strong debate rages on the proper methods to monitor viable *Cryptosporidium* and *Giardia*). A series of studies have found that back flushing of sand filters at drinking water treatment plants resuspend protozoa, and can become a significant source of cysts/oocysts (States *et al.*, 1997; Lechevalier and Norton, 1995). Wastewater effluent is also one of the major sources of protozoa to surface waters, particularly for *Cryptosporidium* (States *et al.*, 1997; Lechevalier *et al.*, 1991; Stern, 1996).

Chemical disinfection can inactivate cysts and oocysts, but typically requires chemical pretreatment, higher doses, and longer contact times than when used to inactivate fecal coliforms. Researchers are beginning to study the best ways to inactivate cysts and oocysts. Physical abrasion, ammonia, low moisture content, freeze-thaw conditions, and very high temperatures (25-30 degrees C) have all been found to inactivate protozoa to some degree.

There is no monitoring data to assess whether stormwater practices can effectively remove *Giardia*, *Cryptosporidium* or *Salmonella*. Given that few effective removal mechanisms exist for these durable pathogens, it is speculated that it will be much harder to remove them compared to fecal coliform bacteria. Additional research is needed to answer this question.

#### Ability of Watershed Practices to Treat Bacteria Sources

##### Effectiveness of Stormwater Practices

Stormwater treatment practices must be extremely efficient if they are to produce storm outflows that meet the 200 MPN standard for fecal coliform bacteria from a site. Assume for a moment that a site experiences a fecal coliform concentration equivalent to the national mean of 15,000 per 100 ml during a storm. A stormwater practice would need to achieve a 99% removal rate for fecal coliform to meet the standard. To date, performance monitoring research has indicated that no stormwater practice can reliably achieve a 99% removal rate of any urban pollutant on a consistent basis.

To date, only 24 performance monitoring studies in our database have actually measured the input and output of fecal coliform bacteria from stormwater practices during storm events. The Center's stormwater pollutant removal database includes ten ponds, nine sand filter and five swales (Table 2). The majority of performance studies have focused on fecal coliform or fecal strep as bacterial indicators, with just a few observations for *Pseudomonas* and *E. coli*. It should be noted that fecal coliform monitoring does not lend itself to automated monitoring techniques because of holding time limitations. Consequently, estimates of efficiency are typically based on grab sampling.

For the 10 stormwater ponds, mean fecal coliform removal efficiency was about 65% (range -5 to 98%). The mean removal efficiency calculated for nine sand filters was lower (about 50%), and these practices had a wider range in removal (-68 to +97%). It should be noted that most sand filter performance data has been collected during warm seasons and most sites were in Texas. No performance monitoring data were available to assess the capability of infiltration practices or stormwater wetlands on coliform removal.

Most researchers report a few episodes of negative fecal coliform removal during the course of their sampling efforts. Figure 2 provides a typical example of the variability in bacteria removal in a North Carolina wet pond monitored by Borden and his colleagues (1996). The limited data on fecal streptococci and *E. coli* removal appears to fall within the same range as fecal coliform removal (Table 2).

##### Outflow Concentrations from Stormwater Practices

Pollutant removal performance can be strongly influenced by the variability of the pollutant concentrations in incoming stormwater. If inflow concentrations are near an "irreducible level," a low or negative removal can be recorded, even though outflow concentrations discharged from a stormwater practice are still relatively low (see article 65). This behavior may explain the high concentration of bacteria often found in stormwater pond outflows. Table 3 compares outflow concentra-

Table 2: Comparison of Mean Bacteria Removal Rates Achieved by Different Stormwater Practices

Stormwater Management Practice	Fecal coliform	Fecal streptococci	<i>E. coli</i>
Ponds	65% (n=10)	73% (n=4)	51% (n=2)
Sand filters	51% (n=9)	58% (n=7)	No data
Swales	-58% (n=5)	No data	No data

R0079846

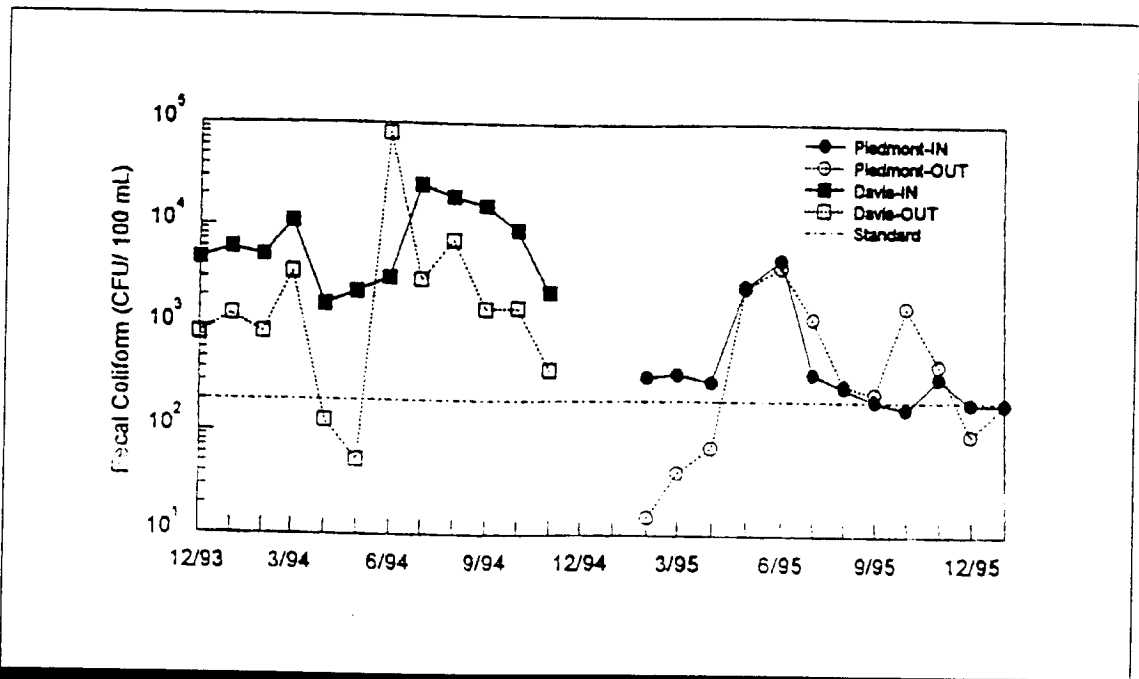

Figure 2: Inflow and Outflow Bacteria Levels in a North Carolina Wet Pond (Borden *et al.*, 1996)

tions among stormwater practices and suggests that most practices discharge fecal coliform bacteria in the ranges of 2,500 to 5,000 colonies per 100 ml, or about 12 to 25 times the water contact recreation standard.

*Effectiveness of Stream Buffers*

Our current knowledge about the bacteria removal capability of stream buffers is rather sparse. Indeed, at the present time, no data exist on the performance of either forested stream buffers or grass filter strips in removing bacteria from urban stormwater runoff. Some indication of their potential effectiveness, however, can be inferred from the performance of grass filter strips used to control runoff from crops and livestock operations. Taken together, these studies suggest that grass filter strips have only a modest capability to remove fecal coliforms from runoff.

For example, Coyne *et al.* (1995) found that grass filter strips were able to remove 43 to 70% of fecal coliforms in two experimental grass filter plot studies, while Young *et al.* (1980) reported 70% coliform removal from a 100-foot grass filter strip. Two other researchers, however, found that grass filter strips had essentially no ability to remove fecal coliform due to short flow lengths (Dickey and Vanderholm, 1981) or extremely high influent concentrations (Schellinger and Clausen, 1992).

It is very doubtful whether an urban stream buffer could exceed the 70% maximum removal rate observed for agricultural stream buffers, given coliform sources within stream buffers such as wildlife, plants and even soils, the relatively narrow band of adjacent land that



Table 3: Comparison of Mean Bacteria Removal Rates (Colonies/100ml) Achieved by Different Stormwater Practices

Stormwater Management Practice	Fecal coliform	Fecal streptococci	<i>E. coli</i>
Ponds	5,144 (n=9)	3,381 (n=4)	869 (n=2)
Sand filters	5,899 (n=9)	16,088 (n=7)	No data
Swales	2,506 (n=3)	No data	No data

can be effectively treated, and the tendency to create channelized flows.

Another line of evidence suggests that urban stream buffers or filter strips may have little potential to remove fecal coliforms from urban stormwater. Five researchers have examined whether grass channels can effectively filter or trap bacteria as stormwater passes through them. Depending on storm size, the swales exhibited shallow concentrated flow, or more rarely, sheetflow conditions. As a group, the grass swales were found to have no ability to reduce fecal coliform levels, with zero or negative changes in concentration reported in four out of five studies (see Table 2 and article 116). Pet droppings, in-situ multiplication and short travel times were all cited as reasons for the poor performance of swales. Swales had a geometric mean outflow concentration of about 2,500 MPN per 100 ml (Table 3). It should be noted that these performance studies did not account for bacteria reduction by soil filtration under the swale.

#### *Effect of Source Control in Reducing Bacteria Levels.*

Source control seeks to reduce or eliminate sources of bacteria in urban watersheds before they come into contact with stormwater. Common source control programs focus on pet waste cleanup, proper disposal of kitty litter, pumpouts of boat sewage, septic system maintenance, discouraging resident waterfowl and general urban housekeeping. While source control is desirable, very little monitoring has been conducted to determine if it can actually reduce watershed bacteria levels. One study that evaluated the effectiveness of source control in urban watersheds was conducted by Lim and Oliveri (1982), who reported that bacterial densities were generally lower in well-maintained Baltimore alleys compared to alleys in poor condition (e.g., trash and refuse piles).

The ultimate effectiveness of any bacteria source control effort is dependent on four factors. First, how prevalent is the behavior that education programs seek to modify? Second, how effective are education or enforcement programs in reaching the target population? Third, what specific educational or enforcement techniques are effective in actually changing the behavior of the target population? Finally, what realistic bacteria reductions in a watershed could be expected if the target population actually changed its behavior?

Consider for a moment the most common bacteria source control program: getting pet owners to clean up after their dogs. A recent phone survey of dog owners in the Chesapeake Bay indicated that 59% of respondents claimed to clean up after their dog most or all of the time, while 38% of the respondents reported that they rarely or never did so (CWP, 1999). Most dog walkers understood the water quality or public health consequences of their behavior: 65% agreed with the

statement that pet waste can be a source of bacteria and nutrients to nearby streams (27% disagreed). Interestingly, the walkers who didn't always clean up after their dogs showed little interest in changing their behavior. Factors that might prompt them to clean up more often were complaints by neighbors (21%), a simple sanitary collection method (17%), convenient disposal locations along trails or parks (17%) and fines (7%). One-third of all dog walkers, however, indicated that none of these factors would induce them to change their behavior. Clearly, pet waste source control programs will need to be very creative to alter these deeply rooted attitudes.

Would these "bad actors" respond more to the stick of an enforcement approach or the carrot of an education approach? What outreach techniques really attract their attention? How much bacteria do they generate in a watershed, and what realistic bacterial reductions could result if some or all of the bad actors changed their behavior? Until we can answer these questions, it is very difficult to craft effective source control programs, and virtually impossible to assign a "watershed bacteria reduction" for source control.

#### *Effect of Improving Wastewater Disposal and Conveyance.*

In watersheds where untreated wastewater is a documented source of bacteria, basic repairs to the wastewater system can produce impressive local reductions in bacteria levels. For example, several communities have measurably reduced bacteria levels by connecting homes with failing septic systems to sanitary sewer lines, rehabilitating aging sanitary sewer lines, eliminating illicit/illegal connections, providing pumpouts of recreational sewage, and treating combined sewer overflows (Field and O'Connor, 1997; NRDC, 1999). While these measures can be an effective strategy for reducing extremely high bacteria levels in dry and wet weather flows in urban watersheds, they do not address bacteria contributed by stormwater.

### **Improving Bacteria Treatment By Watershed Practices**

#### *Stormwater Practices*

Few stormwater regulations provide specific guidance on how to design or select stormwater practices for greater bacteria removal. Several design enhancements are provided below that might be able to enhance the performance of the current generation of stormwater practices.

- Create high light conditions in the water column of stormwater ponds or wetlands. For example, storage can be provided in a series of separate and rather shallow cells. The last cells should have lower turbidity and therefore permit greater UV light penetration.



- Provide additional retention or detention time in stormwater ponds to promote greater settling (i.e. two to five days). Alternatively, engineers could size ponds based on a smaller minimum design particle (say 15 microns).
- Design inlet and outlet structures of stormwater ponds to prevent bacteria-laden bottom sediments from being resuspended and exported. Reducing turbulence is essential for "dry" extended detention ponds that do not have a "pool barrier" to trap and retain bottom sediments.
- Reduce turf and open water areas around stormwater ponds so that resident geese and waterfowl populations do not become established and become an internal bacterial source.
- Add shallow benches and wetland areas to stormwater ponds to enhance the plankton community and therefore increase bacterial predation.
- Infiltration practices can play a role in reducing bacteria yields to surface waters where soil conditions permit. Optimal soil infiltration rates range from 0.5 to 2.0 inches. Even when infiltration is not feasible at a site, designers should endeavor to achieve as much soil filtration as possible through the use of filter strips, rooftop disconnection and open channels.
- If filtering practices are used, employ finer-grained media in the filter bed with a small diameter (say, 15 microns), or at least provide a finer-grained layer at mid-depth in the filter profile. The typical "concrete-grade" sand used in most sand filters may be too coarse-grained to prevent coliform breakouts. The use of finer-grained media, however, could lead to more chronic clogging of the filter bed. In any event, sand filters are not likely to achieve high bacteria removal unless the process for pretreatment and/or filtration is extended for 40 hours or more. This is most easily done by extending the detention time in the sedimentation chamber used for pretreatment.
- Remove trapped sediments from filter pretreatment chambers on a more frequent basis during the growing season. In addition, "dry" pretreatment chambers may be more desirable since bacteria-laden sediment would be subject to both sunlight and desiccation. In general, sand filters should be oriented to provide maximum solar exposure.
- Consider using bioretention, infiltration and dry swale practices that employ soil filtration. Given sufficient pretreatment and soil filtering depth, these practices have the potential to achieve bacterial removal rates comparable to functioning septic systems. Their actual performance monitoring and longevity in the field, however, needs

more study before stormwater "soil filters" are recommended for bacteria-limited watersheds.

- Avoid creating internal bacterial sources in the stormwater conveyance system, such as ditches, catch basins, swales, or sediment storage within the storm drain network. In bacteria-limited catchments, conveyance systems should be designed to be either self-cleansing or promote maximum sediment retention. Dry swales, which employ soil filtration and have an under drain, are probably superior to grass swales from a bacteria reduction standpoint.
- Locate new stormwater outfalls to maximize distance from any water intakes, beaches or shellfish beds.

Research is needed to determine what, if any, additional bacteria removal could be produced by these design enhancements. In addition, performance monitoring is urgently needed to evaluate whether *Giardia* or *Cryptosporidium* can be removed by current or enhanced stormwater practices. Clearly, there are upper limits on what gravity-driven stormwater practices can actually achieve. Even an advanced secondary wastewater treatment that filters its effluent still discharges fecal coliform at the  $10^3$  to  $10^5$  levels before final chemical disinfection (ASCE, 1998). This suggests that more advanced disinfection techniques may need to be incorporated into stormwater practices if they ever will be able to meet bacterial standards in urban waters.

#### Stream Buffers

The ability of urban stream buffers to remove bacteria has never been tested in the field, so the following design enhancements are based solely on engineering theory and bacteria behavior. An ideal stream buffer might be composed of three lateral zones: a stormwater depression area that leads to a grass filter strip that in turn leads to a forested buffer. The stormwater depression is designed to capture and store stormwater during smaller storm events and bypass larger stormflows directly into a channel. The captured runoff within the stormwater depression can then be spread across a grass filter designed for sheetflow conditions for the water quality storm. The grass filter then discharges into a wider forest buffer designed to have zero discharge of surface runoff to the stream (i.e., full infiltration of sheetflow).

The outer zone of a stream buffer must be engineered in order to satisfy these demanding hydrologic and hydraulic conditions. In particular, simple structures are needed to store, split and spread surface runoff within the stormwater depression area. Although past efforts to engineer urban stream buffers were plagued by hydraulic failures and maintenance problems, recent experience with similar bioretention areas has been

much more positive (Claytor and Schueler, 1996). Consequently, it may be useful to consider elements of bioretention design for the outer zone of an urban stream buffer (shallow ponding depths, partial under drains, drop inlet bypass, etc.).

Even when stream buffers cannot be engineered, they can be managed for bacterial source control. For example, grazing within a urban stream buffer should not be permitted, and livestock should be excluded from stream buffers adjacent to hobby farms and horse pastures.

#### Source Control

Bacteria source control remains in its infancy as a watershed practice. While the value of source control efforts such as pet waste cleanup is obvious, it is not always clear how to improve its effectiveness. Several lines of research are probably worth pursuing:

- Catchment scale monitoring to directly link pets to pollution
- Attitude surveys that profile the psychology of pet owners for devising better ad campaigns
- Buffer training for dogs
- Research to develop a more convenient and sanitary product to retrieve and dispose of pet wastes

#### Summary

Current stormwater, buffer and source control practices do not appear capable of removing enough fecal coliform bacteria to meet the 200 MPN water contact recreation standard in stormwater discharges, unless the receiving water is well-mixed and diluted with cleaner water. The 50 to 75% bacteria removal reported for stormwater and buffer practices falls well short of the 99% removal needed to meet standards. Considering that the outflow concentration from stormwater practices is on the order of 2,500 to 5,000 MPN/100 ml, it is probable that bacterial concentration will always exceed pre-development conditions in most urban watersheds, even if stormwater treatment and buffer practices are fully implemented and all wastewater discharges are eliminated.

—TRS

#### References

References denoted by an asterisk (\*) were used in the bacteria removal performance analysis provided in Tables 2 and 3.

ASCE. 1998. *Design of Municipal Wastewater Treatment Plants*. Fourth Edition. Volume 2. American Society of Civil Engineers Manual and Report on Engineering Practice No. 76. Water Environment Federation MOP # 8.

- Auer, M.T., Niehaus, S.I. 1993. "Modeling Fecal Coliform Bacteria—I. Field and Laboratory Determination of Loss Kinetics." *Water Resources* 27(4):695-701.
- Bagley, S., M. Auer, D. Stern and M. Babiera. 1998. "Sources and Fate of Giardia Cysts and Cryptosporidium Oocysts in Surface Waters." *Journal of Lake and Reservoir Management* 14(2-3):379-392.
- Bank, H. and M. Schmehl. 1990. "Bactericidal Effectiveness of Modulated UV Light." *Applications of Environmental Microbiology* 56(12):3888-3889.
- Bannerman, R. and R. Dodds. 1992. Unpublished stormwater pond data. Bureau of Water Resources Management. Wisconsin Dept. of Natural Resources. Madison, WI.\*
- Borden, R. C., J. L. Dorn, J. B. Stillman and S. K. Liehr. 1996. Draft Report. *Evaluation of Ponds and Wetlands for Protection of Public Water Supplies*. Dept. of Civil Engineering. North Carolina State University. Raleigh, N. C. \*
- Center for Watershed Protection. 1999. *Urban Nutrient Behavior Survey: Chesapeake Bay Resident Attitudes*. Ellicott City, MD.
- City of Austin, TX. 1990. *Removal Efficiencies of Stormwater Control Structures*. Final Report. Environmental Resource Management Division.\*
- City of Austin, TX. 1997. *Evaluation of Nonpoint Source Controls, An EPA/TNRCC Section 319 Grant Report*. Volume 1. Final Report. Environmental Resource Management Division.\*
- Claytor, R. and T. Schueler. 1996. *Design of Stormwater Filtering Systems*. Chesapeake Research Consortium. Center for Watershed Protection. Ellicott City, MD. 212 pp.
- Coyne, M.S., R.A. Gilfillen, R.W. Rhodes, and R.L. Blevins. 1995. "Soil and Fecal Coliform Trapping by Grass Filter Strips During Simulated Rain." *Journal of Soil and Water Conservation* 50: 405-408.
- Dickey, E.C. and D.H. Vanderholm. 1981. "Vegetative Treatment of Livestock Feedlot Runoff." *Journal of Environmental Quality* 10:279-284.
- Driscoll, E. 1981. Unpublished notes of fecal coliform removal at Unqua NURP Pond.\*
- Egan, T., J. Burroughs and T. Attaway. 1995. "Packed Bed Filter." In *Proceedings of the 4th Biennial Research Conference*. Southwest Florida Water Management District. Brookeville, FL.\*
- Field, R., M. O'Shea and M. Brown. 1993. "The Detection and Disinfection of Pathogens in Storm-Generated Flows." *Water Science and Technology* 28(5):311-315.



R0079850

- Field, R. and T. O'Connor. 1997. "Control and Treatment of Combined Sewer Overflows." In *Control and Treatment of Combined Sewer Overflows*. 2nd Edition. P. Moffa, editor. Van Nostrand Reinhold, New York, pp. 124-218.
- Godfrey, A. 1992. "Sources and Fate of Microbial Contaminants." In *Recreational Water Quality Management Volume 2: Freshwaters*. D. Kay and R. Hanbury editors. Ellis Horwood, New York, NY, pp. 137-154.
- Goldberg, D. 1993. *Dayton Avenue Swale Biofiltration Study*. Seattle Engineering Dept., Seattle, WA.\*
- Horsley, S. W. 1995. "The Storm Treatment System - a New Technology Stormwater Runoff." Tech. Note No. 67. *Watershed Protection Techniques* 2(1).\*
- Hydroqual, Inc. 1996. *Design Criteria Report, Kensico Watershed Stormwater Best Management Facilities, Appendix C*. New York City Dept. of Environmental Protection. 240 pp.
- Jones, S. and R. Langan. 1996. *Assessment of the Effectiveness of Permanent Stormwater Control Measures*. Final report to New Hampshire Office of State Planning. University of New Hampshire. Portsmouth, NH 22 pp. \*
- LeChevallier, M., and W. Norton. 1995. "Giardia and Cryptosporidium in Raw and Finished Water." *Journal AWWA*. 87(9): 54-68.
- LeChevallier, M., W. Norton and R. Lee. 1991. "Occurrence of Giardia and Cryptosporidium in Surface Water Supplies." *Applied and Environmental Microbiology*. 57(9): 2610-1616.
- Lim, S. and V. Olivieri. 1982. *Sources of Microorganisms in Urban Runoff*. Johns Hopkins School of Public Health and Hygiene. Jones Falls Urban Runoff Project. Baltimore, MD. 140 pp. \*
- Mancini, J. 1978. "Numerical Estimates of Coliform Mortality Rates Under Various Conditions." *Journal WPCF*. pp. 2477-2484.
- Natural Resources Defense Council (NRDC). 1999. *Municipal Solutions to Stormwater Pollution*. Draft Report. New York, NY. 324 pp.
- Olivieri, V., C. Kruse, K. Kawata, and J. Smith. 1977. *Microorganisms in Urban Stormwater*. USEPA Report No. EPA-600/2-77-087 (NTIS No. PB-272245).
- O'Shea, M. and R. Field. 1992. "An Evaluation of Bacterial Standards and Disinfection Practices Used for the Assessment and Treatment of Stormwater." In *Advances in Applied Microbiology*. Academic Press. New York, NY. pp. 21-40.
- Robertson, J. and S. Edberg. 1997. "Natural Protection of Spring and Well Drinking Water Against Surface Microbial Contamination: 1. Hydrogeological Parameters." *Critical Reviews in Microbiology* 23(2):193.
- Schellinger, G. R. and J. C. Clausen. 1992. "Vegetative Filter Treatment of Dairy Barnyard Runoff in Cold Climates." *Journal of Environmental Quality* 21: 40-45.
- Schillinger, J. and J. Gannon. 1982. *Coliform Attachment to Suspended Particles in Stormwater*. U.S. Environmental Protection Agency. NTIS PB 83-108324. 106 pp.
- Seattle Metro and Washington Dept. of Ecology. 1992. *Biofiltration Swales: Performance, Recommendations, and Design Considerations*. Publication #657. Water Pollution Control Dept., Seattle Washington.\*
- Stanley, D. 1994. *An Evaluation of the Pollutant Removal of a Demonstration Urban Detention Pond*. Albermarle-Pamlico Estuary Study. APES Report 94-07.\*
- States, S., K. Stadterman, L. Ammon, P. Vogel, J. Baldizar, D. Wright, L. Conley and J. Sykora. 1997. "Protozoa in River Water: Sources, Occurrence and Treatment." *Journal AWWA* 89(9): 74-83.
- Stern, D. 1996. "Initial Investigation of the Sources and Sinks of Cryptosporidium and Giardia Within the Watersheds of the New York City Water Supply System." In *Proceedings of a Symposium on New York City Water Supply Studies*. McDonnell et al. editors. American Water Resources Association. Herndon, VA. TPS-96-2 184 pp.
- Stormwater Assessment and Monitoring Performance Program. 1997. *Harding Park Retrofit Wet Pond Facility Progress Report, Rouge River Stormwater Facility Progress Report #2*. Ontario Ministry of Environment, Toronto, Canada. \*
- Thoman, R. and P. Mueller. 1987. *Principles of Surface Water Modeling and Control*. Chapter 5. Harper Collins. New York, NY. 450 pp.
- Viesmann, W. and M. Hammer. 1993. *Water Supply and Pollution Control*. Fifth edition. Harper Collins. New York, NY. 860 pp.
- Welborn, C. and J. Veenhuis. 1987. *Effects of Runoff Controls on the Quantity and Quality of Urban Runoff at Two Locations in Austin, Texas*. U. S. Geological Survey. Water-Resources Investigations Report 87-4004. Austin, TX. \*
- Young, R., T. Huntrods and W. Anderson. 1980. "Effectiveness of Vegetated Buffer Strips in Controlling Pollution from Feedlot Runoff." *Journal of Environmental Quality* 9: 483-487.

R0079851

## Article 68

Technical Note #90 from *Watershed Protection Techniques*, 2(4): 495-499

# The Economics of Stormwater Treatment: An Update

Stormwater management can be the single greatest "out-of-pocket" cost that developers have to pay to meet local watershed protection requirements. Yet, surprisingly, very little is known about the actual cost of constructing stormwater practices. The last major study on the cost of urban stormwater management occurred over a decade ago when Wiegand and his colleagues (1986) investigated the construction cost of 65 stormwater management ponds in the Washington metropolitan area.

Since then, developers and watershed managers alike continue to be keenly interested in questions about the economics of stormwater practices (Brown and Schueler, 1997). For example, has the cost of constructing stormwater management facilities increased over the last decade? If so, by how much? To what extent have new design and permitting requirements pushed up these costs? How much does it cost to build sand filters, bioretention areas or stormwater wetlands and other practices that were unheard of a dozen years ago? Are they cheaper to construct than ponds? What share of total stormwater management costs are due to water quality requirements as opposed to stormwater detention for peak discharge control? Do stormwater practices still exhibit economies of scale, i.e., is it still cheaper to construct a single large stormwater practice than a series of smaller ones to serve the same drainage area?

To address these questions, the Center undertook a second study in 1996 to update design and construction cost data for urban stormwater practices. The cost survey included 73 stormwater practices in the Mid-Atlantic area for which bond estimates, engineering estimates and actual construction contracts were available. The major stormwater practices that were analyzed included 41 pond systems (18 dry extended detention ponds and 20 wet extended detention and wet ponds and three wetlands); 11 bioretention areas, 11 sand filters and five infiltration trenches. Cost estimates for the practices were obtained from 14 private engineering firms and public agencies operating in Maryland and Virginia. Consequently, the population of stormwater practices that were sampled spanned a wide range of local design criteria and stormwater permitting requirements. In addition, the Center reviewed each stormwater practice design to determine watershed area, impervious cover, water quality storage volume and storm-

water detention storage. Not all cost estimates were complete. In particular, specific cost information for control structures, landscaping, and erosion and sediment control (ESC) were frequently missing. These gaps were filled by using "unit rates" for each construction component developed from a survey of typical design and construction costs in the region. Unit rates for the basic component costs involved in stormwater practice construction are compared in Table 1.

The adjusted stormwater practice cost database was then statistically analyzed to examine the relationship between storage volumes (stormwater quality and quantity) and base construction cost (i.e., excavation and grading, ESC, and control structure costs) first established in the earlier Wiegand study. In general, the new study confirmed that stormwater storage volume was a reasonably strong indicator of construction cost for urban stormwater practices.

The new cost study found a strong relationship between pond storage volume and total construction cost of 41 stormwater ponds (see Figure 1). The equation describing the relationship had about the same slope and correlation coefficient as the 1986 pond cost equation (Table 2). The two cost equations are graphically compared in Figure 2. From this analysis, it is evident that the cost of providing a cubic foot of pond storage has climbed by 75% over the last decade. When inflation is factored out, the real cost increase is much smaller—about 30%. The higher cost is attributed to the adoption of enhanced pond design criteria, particularly those that have specified longer-lived but more costly construction materials (e.g., concrete vs. corrugated metal pipes).

In general, about a third of every dollar spent on stormwater pond construction was devoted to water

Table 1: Comparison of Basic Component Cost of Stormwater Practice Construction

Basic Components of Construction Costs	Ponds	Sand Filters	Bioretention
Excavation/Grading	48 %	21 %	25 %
Control Structure	36	68	50
Appurtenances	16	11	25 <sup>a</sup>

<sup>a</sup> includes landscaping costs

**Table 2: Comparison of Cost Prediction Equations in 1986 and 1996 Studies**

Practice Category	1986 Equation	(r <sup>2</sup> )	1996 Equation	(r <sup>2</sup> )
All Ponds	CC = 6.11 V <sub>s</sub> <sup>0.75</sup>	(0.80)	CC = 20.80 V <sub>s</sub> <sup>0.70</sup>	(0.77)
Dry ED Ponds	CC = 10.71 V <sub>s</sub> <sup>0.69</sup>	(0.73)	CC = 8.16 V <sub>s</sub> <sup>0.78</sup>	(0.93)
Bioretention	N/A	—	CC = 5.67 V <sub>s</sub> <sup>0.99</sup>	(0.92)
Sand Filters	N/A	—	No acceptable equation	—
Infiltration Trenches	CC = 26.55 V <sub>s</sub> <sup>0.63</sup>	(0.93)	Testing indicates 1986 equation is no longer valid	—

CC = Base construction cost, does not include costs for design, engineering and contingencies. To compute total cost, multiply base construction cost by 1.25 (1986 equations) and 1.32 (1996 equation) respectively.  
V<sub>s</sub> = Storage volume up to the crest of emergency spillway in cubic feet.  
N/A = Not analyzed as part of study.

quality control, with the remainder spent on flood control storage (detention of the two- and 10-year design storms). The cost study confirmed that significant economies of scale exist in pond construction, i.e., it is much cheaper to build a cubic foot of storage in a large pond than a small one. Lastly, the study indicated that dry extended detention ponds were only marginally less expensive than other pond options (wet ponds, wetlands, and wet extended detention ponds).

An example of how the pond cost equations can be used is provided in Table 3, which describes two typical development scenarios. To get a planning level estimate of stormwater cost, a designer needs to compute the combined storage volume needed for water quality and detention requirements. Once the cubic feet of pond storage is known, it is a simple matter to plug it into the 1996 pond equation to obtain a preliminary cost estimate. For the 50-acre residential development

scenario shown in Table 3, the estimated total cost to design and construct a stormwater pond is computed to be over \$98,000, of which \$36,500 is specifically for water quality treatment. For the sake of comparison, the predicted pond cost for the same development scenario 10 years ago was computed using the 1986 cost equation and adjusting for inflation. An estimate of the lifetime nutrient reduction cost of the stormwater pond is also easily calculated. In this case about \$84 and \$20 per pound of phosphorus and nitrogen removed, respectively.

A very strong relationship was developed to predict the cost of bioretention areas on the basis of the water quality volume they provide (see Figure 3). Bioretention areas are becoming a very popular water quality practice in the mid-Atlantic region (they are designed for pollutant removal but not flood control).

**Table 3: Costs of Stormwater Management for Two Development Scenarios**

	Scenario 1 5-acre commercial	Scenario 2 50-acre residential subdivision
Required WQ Storage	0.264 acre-feet	1.41 acre-feet
Required Detention Storage	0.740 acre-feet	3.25 acre-feet
Pond Construction Cost, 1986 <sup>a</sup>	\$25,210 (\$9,328)	\$76,709 (\$28,382)
Pond Construction Cost, 1996	\$34,787 (\$12,871)	\$98,738 (\$36,533)
Annual P and N Loads <sup>b</sup>	9.8 lbs P / 65 lbs N	36.7 lbs P / 242 lbs N
P and N Removal <sup>c</sup>	115 lbs P / 487 lbs N	431 lbs P / 1815 lbs N
Cost per Pound Removed <sup>d</sup>	\$ 112 per lb P / \$26 per lb N	\$ 84 per lb P / \$20 per lb N

<sup>a</sup> Adjusted to 1996 dollars using an inflation factor of 1.32. Parentheses indicate water quality treatment costs.  
<sup>b</sup> As computed by the Simple Method.  
<sup>c</sup> Assuming national TP and TN removal of 47% and 30% respectively, over a 25-year period.  
<sup>d</sup> Total cost divided by 25-year design life.



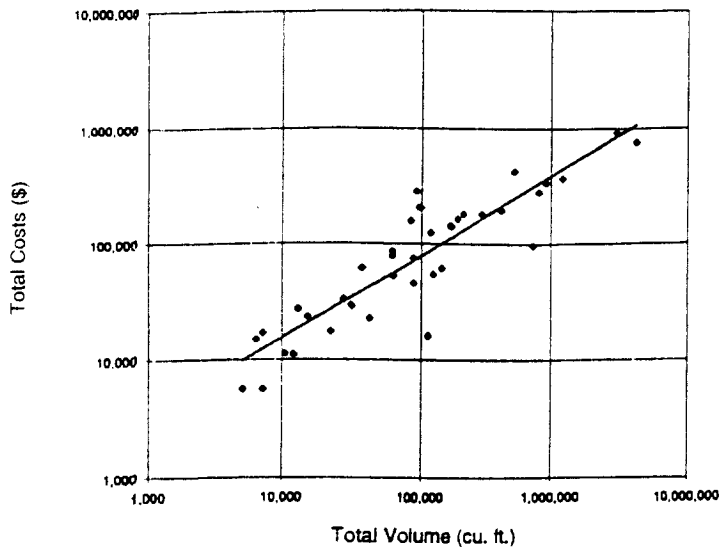

**Figure 1: Relationship Between Total Construction Cost and Storage Volume for 40 Stormwater Ponds in the Mid-Atlantic Region**

*The cost of constructing a stormwater pond is directly related to the storage volume provided.*

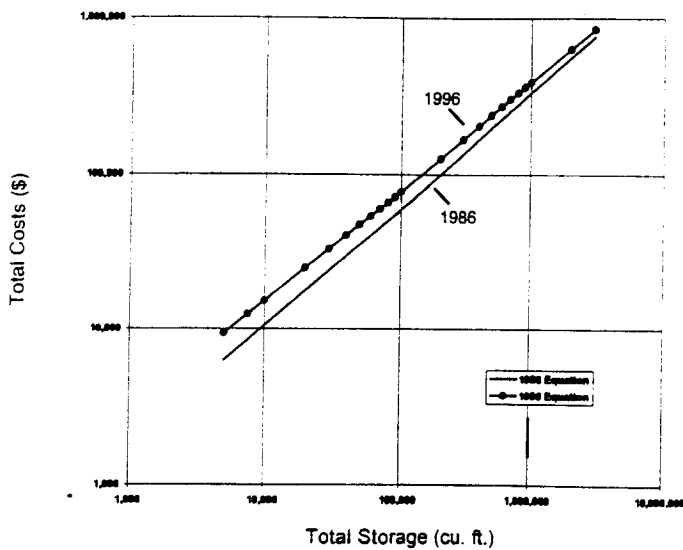

**Figure 2: Comparison of 1986 and 1996 Pond Cost Prediction Equations**

*The two cost equations are both expressed in terms of 1996 dollars, and have the same basic slope and correlation coefficient. The top line represents the 1996 dataset, which is approximately 30% more expensive in real terms.*

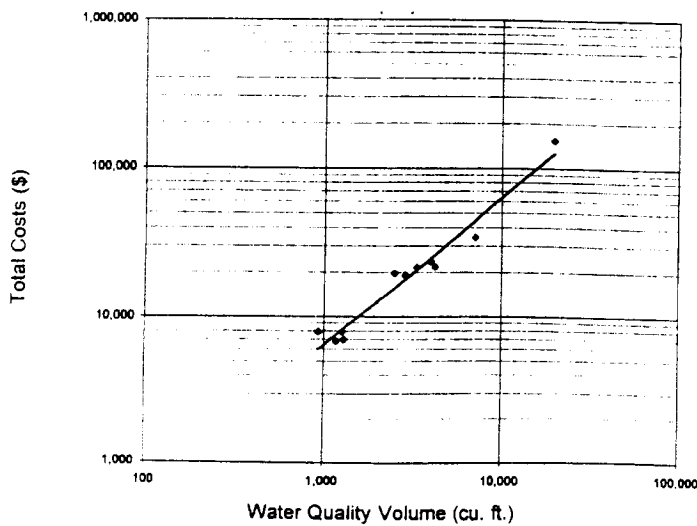

**Figure 3: Relationship Between Total Construction Cost and Storage Volume for 12 Bioretention Areas**

*The cost of installing a bioretention area can be accurately predicted on the basis of the water quality volume it provides. Bioretention is seldom used to provide quantity control.*



The study found no economies of scale for bioretention, which is consistent with the fact that these practices are sized as a flat percentage of site area. Another way of expressing the cost of bioretention is that they generally cost about \$6.40 per cubic foot of quality treatment.

Cost data for sand filters was limited and extremely variable, and no predictive equations could be developed at this time. The variability was due to many diverse designs (surface and underground sand filters) and control structures. This data, however, were used to compute average costs. Filter costs ranged from \$3 - \$6 per cubic foot of quality storage, which is higher than an earlier surface sand filter cost study (Tull, 1990).

Since only five infiltration trenches were included in the Center study, no attempt was made to derive a cost equation. Instead, the data were used to determine whether the 1986 infiltration cost equation was still valid. This testing indicated that the older cost equation was no longer valid, as it consistently underestimated costs by a factor of two or more. Higher costs for infiltration trenches appeared to be a result of greater pretreatment measures and other enhanced design fea-

tures that have come into more widespread use (observation wells, sand layers, etc.). Overall, the average construction cost for infiltration trenches ranged from \$2 to \$9 per cubic foot of water quality storage, with a mean of \$3 per cubic foot, exclusive of costs for design and testing.

#### Summary

Our study suggests that the real costs of providing stormwater have increased over the past decade. Part of this increase is due to higher costs to design ponds and to secure permits. For a typical stormwater pond, the sum of all costs related to design, permitting, geotechnical testing, landscaping, contingencies, and ESC control now comprise 32% of the base construction cost (Table 4). If wetlands or streams are situated near a proposed pond site, these costs escalate to 37% of the base construction cost. These factors can be compared to the 25% of base construction cost rate that was an industry standard a decade ago. The Center survey indicates that these design cost increases can be attributed to longer plan review times: some seven months, on average, from plan submittal to final plan

Figure 4: Generalized Relationship Between Unit Stormwater Management Cost and Site Size

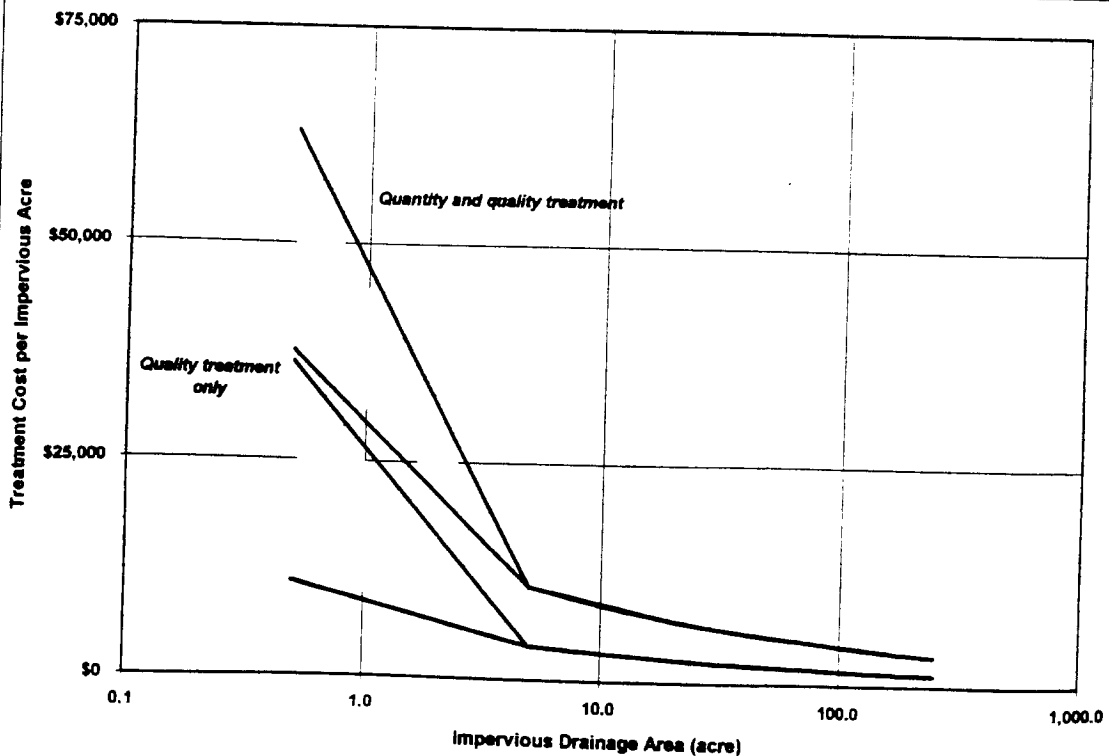

The cost of providing quantity and quality control climbs dramatically when development sites are small, due to the need for underground detention and separate quality practices. Considerable range in treatment costs is also common at small sites.



approval— even longer if wetlands permits are involved. Other reported factors that drive up costs are multiple and conflicting agency reviews and changes in local design criteria and submittal requirements.

The current cost study clearly supports the notion that ponds are the most cost-effective option to provide stormwater quantity and quality control. A generalized relationship illustrated typical unit costs to treat stormwater as a function of site size (Figure 4). The curves show a dramatic drop in the unit cost of providing both stormwater quantity and quality control once sites exceed five or more acres of contributing impervious drainage area. In this range, a single pond can provide both quantity and quality control in a cost-effective manner.

When sites become too small, however, surface ponds are no longer an effective option. Costs begin to skyrocket at small sites for two reasons. First, as available surface becomes scarce, engineers are increasingly driven “underground” to provide needed detention for quantity control. Second, quality control must be provided by an additional practice, such as sand filters, bioretention, or infiltration. In each case, the cost of each practice on a small site is five to 10 times more expensive on a unit area basis than a comparable stormwater pond. The wide range in costs for small site stormwater practices shown in Figure 4 indicates that designers can expect to pay from \$30,000 to \$50,000 to treat the quality and quantity of runoff from a single impervious acre.

It is much more expensive to meet stormwater requirements on a small site than on a larger one. This clearly implies that larger “regional” or multi-site ponds are more cost-effective watershed strategy than on-site stormwater quality and quantity management, particularly at small sites.

—TRS

**Table 4: Typical Design and Engineering Costs for Stormwater Practices as a % of Basic Construction Cost**

<b>Rule-of-Thumb Estimates of Typical Practice Design and Engineering (D&amp;E) Costs</b>	<b>Percent of Base Construction Cost</b>
Engineering design	6
Engineering design, wetlands present	10
Standard permitting process	3
Permitting process, wetlands present	4
Geotechnical investigations	4
Structural design	3
Erosion and sediment control for practice	5
Landscaping	4
Contingency/unknown costs	7
<b>Total additional D &amp; E costs</b>	<b>32</b>
<b>Total additional D &amp; E costs, wetlands present</b>	<b>37</b>
<b>Total additional D &amp; E costs (1986)</b>	<b>25</b>

#### References

- Brown, W., and T. Schueler. 1997. *The Economics of Stormwater BMPs in the Mid-Atlantic Region, Final Report*. Center for Watershed Protection. Chesapeake Research Consortium. 40 pp.
- Tull, L. 1990. *Cost of Sedimentation/Filtration Basins*. City of Austin, TX. Unpublished data.
- Wiegand, C., T. Schueler, W. Chittenden and D. Jellick. 1986. "Cost of Urban Runoff Controls." pp. 366-380. In: *Proceedings of an Engineering Foundation Conference*. Urban Water Resources. ASCE. Henniker, NH June 23-27, 1986.



R0079856

## Article 69

*Technical Note #91 from Watershed Protection Techniques, 2(4): 500-502*

# Trends in Managing Stormwater Utilities

**F**aced with rising costs and requirements to manage urban stormwater, many communities are exploring the concept of the "stormwater utility." In this method of stormwater financing, property owners are charged a modest fee for "using" the storm drain network, which is usually based on the amount of impervious area located on their property. In most cases, the fees are piggybacked on local water utility bills. The fees collected are used to finance capital and operating expenses needed for local stormwater management. Stormwater utilities are particularly attractive to communities subject to Phase 1 or Phase 2 of EPA's NPDES municipal stormwater permitting program.

Stormwater utilities can provide a new and reliable source of dedicated funds in an era of local budget austerity. The American Public Works Association considers stormwater utilities the "most dependable and equitable approach available to local government to finance stormwater management." Relatively unknown a decade ago, stormwater utilities are now an important funding mechanism for several hundred cities and counties across the country.

Black & Veatch, a national environmental engineering firm, has recently completed its 1995-1996 comprehensive survey of stormwater utilities throughout the nation. The survey included 97 different utilities from 20 states. The populations served by the utilities ranged

Table 1: The Index of Stormwater Utilities —  
A Profile of Trends Among 97 U.S. Stormwater Utilities  
(Black & Veatch, 1996)

Feel public information/education is essential to success of a stormwater utility .....	61 %
Consider it unnecessary .....	1
Devote more than 2% of operating budget to public education .....	57
Use impervious cover as basis for user fees .....	55
Charge between \$2 and \$4 per month .....	57
Bill on a monthly basis .....	74
User fees included in water or other utility bill .....	35
Revised user fees in the last year .....	35
Revised them (fees) upward .....	89
Credits given if private detention/retention practices exist .....	57
User fees were legally challenged .....	16
User fees were sustained after legal challenge .....	60
Stormwater utility is less than 5 years old .....	55
Stormwater utility covers both capital and O&M costs .....	81
Utility revenue meets most needs or at least most urgent needs .....	82
Utility revenues adequate for all needs .....	11
Property owner responsible for user fee payment .....	65
Water shut off and/or property lein for nonpayment .....	54
Unusually heavy rain and/or floods created major troubles .....	11

00

from 5,000 (Fort Meade, FL) to 3.5 million people (Los Angeles, CA), and the area served varied from 4 to 989 square miles. This survey provides valuable information for urban water managers that are either considering establishing a stormwater utility or have already done so. A partial "index" of some of the more interesting results of the Black & Veatch survey is provided in Table 1.

A critical lesson learned in developing stormwater utilities is the need for careful planning. It is extremely important to establish a comprehensive plan stating the goals of the utility and the steps needed to achieve the goals *before* initiating charges. Determining what aspects of stormwater management will be covered by the utility charges is also an important first step. Utility revenues cover one or more of the following: operations and management, planning, and/or capital improvements.

Public involvement is essential before and after the implementation of a stormwater utility. Communities often help determine financing and rate issues, define general policy and recommend service levels. Educating the public can also keep legal challenges at bay. If meaningful public involvement is provided, there is much less chance that the community will feel that a "rain tax" has been imposed on them. In general, legal challenges are rare (16% have faced legal challenge and most challenges were not sustained).

The general consensus seems to be that stormwater utilities provide an adequate source of funding for many stormwater management needs (Table 2). However, according to Black & Veatch's survey, these fees are usually not sufficient to meet all stormwater management requirements. Only 11% of the respondents reported that their fees were adequate to meet all stormwater management needs, while 44% stated that fees only provide funding for their most urgent needs. So, while user fees are helpful, they are not a cure-all for funding stormwater management. Consequently, it is best to couple utilities with other funding sources.

#### Key Steps for Creating a Successful Stormwater Utility

For those communities contemplating a stormwater utility, the following five steps should be included (Mussman, 1994; Lindsey, 1988a and b). Keep in mind that public involvement is beneficial throughout the process.

##### *Step 1: Estimate revenue requirements*

Cost estimates should be developed for all functions the utility will undertake. Costs vary greatly among communities, often depending on the range of activities performed by the utility. Some utilities apply user fee revenues to operations and management, to planning, and financing capital improvements. Others use rev-

enues only for operation and management costs and rely on the general fund for covering other expenditures. Accurate identification of revenue requirements are crucial for both the development of appropriate charges and legal defensibility.

##### *Step 2: Determine an administrative structure for stormwater management*

Planning for a stormwater utility often begins with a "functional requirements study." Such a study involves determining the scope of activities needed to manage stormwater and identifying the administrative departments best suited to perform each task. Utilities are generally operated by or within the Department of Public Works (DPW), although this is not always the case. A common arrangement is to have the DPW responsible for planning and design, and operations and management, with the Department of Finance responsible for billing.

##### *Step 3: Devise a fee structure and a billing system*

Devising a fee structure and developing a billing system may represent a significant percentage of start up costs and may be the most time consuming aspect of establishing a utility. This is especially the case when extensive digitizing or mapping are required. There are a variety of methods that may be used to analyze the customer base pervious and impervious area within a community (Table 3). Which tools are used depends on their availability.

There are a variety of considerations to determine billing rates, ranging from whom to charge to what costs will be covered by user fee revenues. Three common billing methods involve adding stormwater charges to another utility bill, adding the charges to property tax bills, or creating a new and separate billing system. Each method has its advantages and disadvantages.

Table 2: Activities Financed by Local Stormwater Utilities  
(Black & Veatch, 1996)

Stormwater Program Activity	% of Respondents
Street sweeping	85 %
Public education	80
Erosion/sediment control	78
Stormwater quality management	71
Household toxin collection	67
Illegal discharge detection	59
Storm drain stenciling	58
Commercial/industrial regulation	45

**Table 3: Resources Used to Determine Customer Base**  
(Black & Veatch, 1996)

Resource	% of Respondents
Property tax assessor records	49 %
On-site property measurement	41
Aerial photographs	38
Planimetric map take-offs	23
Geographic Information Systems	20
Other ( e.g., building permits, site plans)	13

**Table 4: Most Effective Public Education Efforts**  
(Black & Veatch, 1996)

Method	% of Respondents
Bill inserts	47 %
Public schools	11
Brochures/flyers	11
Public hearings/presentations	11
Direct mail	10
Speakers bureau	9
Newspaper	8

In most cases, the property owner is responsible for the fees, but in some cases the resident is responsible. Streets, highways, undeveloped land, rail rights-of-way, and public parks are exempt in most communities. A local government should also determine whether it will provide billing credits for properties which limit their impact on the storm sewer system because they have stormwater treatment practices. Black & Veatch suggests providing credits or waivers only when stormwater treatment practices exceed local requirements so that properties that utilize practices that don't meet local requirements will be charged (although only in proportion to the level of runoff they produce).

User fee rates depend on revenue requirements and the size of the stormwater management program. Among survey respondents, the average monthly residential charge was approximately \$2.50, with rates ranging between \$10.98 in Sacramento, CA, to \$.24 in St. Louis, MO. A majority of the rates fell between \$1.00 and \$5.00 per month with 50% of respondents setting their monthly fees between \$2.00 and \$4.00.

*Step 4: Implement a public information program*

Only 1% of the respondents in the Black & Veatch survey said that public information programs were not necessary. Public involvement during and after the

establishment of a stormwater utility is key to its successful implementation. Communities often help determine financing and rate issues, define general policy, and recommend service levels (Table 4).

*Step 5: Adopt stormwater utility ordinances*

Prior to the implementation of a utility, a local government must verify state statutory authority before adopting legislation that specifies the scope of the utility's activities and how it will be financed.

**Summary**

The number of stormwater utilities continues to multiply as communities confront the substantial costs associated with stormwater management programs. The experience of communities that have successfully implemented stormwater utilities underscores the importance of public education and involvement. It should be initially assumed that the public are unaware of the impact of stormwater runoff, or the role they play in maintaining watershed quality. At the same time, it should be assumed that once educated, the public will be discriminating in the services and programs they expect to be delivered from a new stormwater utility.

—JL

**References**

- Black & Veatch. 1996. *1995-1996 Stormwater Utility Survey*. Management Consulting Division. Kansas City, MO. pp. 10.
- Mussman, J.M. and Z. L. Snyder. 1994. *Key Storm Water Rate Development Factors*. Black & Veatch. pp. 12.
- Lindsey, Greg 1988a. *A Survey of Stormwater Utilities*. Stormwater Management Administration; Maryland Department of the Environment. pp. 41.
- Lindsey, Greg 1988b. *Financing Stormwater Management. The Utility Approach*. Maryland Department of the Environment. pp. 45.

# Ponds

R0079860

88



# Pond/Wetland System Proves Effective in New Zealand

The performance of an innovative pond/wetland stormwater treatment system was evaluated in 1992 at a highly industrial site in the Auckland, New Zealand region. The newly retrofitted pond served a 24 acre, 66% impervious, Pacific Steel industrial site, which produces steel from automotive scrap recycled on-site.

As might be expected, the site had high loads of stormwater pollutants—concentrations were from five to ten times higher than residential areas in the Auckland region. This was particularly true for metals—median concentrations of copper, lead, and zinc were 0.14, 0.29, and 0.21 mg/l, respectively.

The pond/marsh system is shown in plan view in Figure 1. Innovative design features included an oil trap near the inlet to recover hydrocarbons, an extremely long flow path (2:1), a submerged berm that creates a quasi-forebay, a shallow marsh zone, and a micropool at the outlet. The total treatment volume averaged 1.92 watershed-inches (0.90 watershed inches when the full site is routed to the facility).

The 1.65 acre facility had 53% of surface area devoted to the pool, and 47% devoted to the marsh. However, 90% of the treatment volume was allocated to

pool, and 10% to the marsh. The runoff frequency spectrum of the Auckland region was generally comparable to that of the American east coast and Midwest regions. In general, the particle-size distribution of the solids are considerably finer than those found in the United States due to the volcanic-derived soils.

Flow-composite monitoring of six storms during 1992 indicated that the pond/marsh system performed very effectively (Table 1). Removal of solids and various forms of phosphorus approached 75%. Removal of total copper, lead, and zinc exceeded 85%. Although nitrate removal was high (62%), a net export of ammonia was observed.

The pond/marsh system was relatively ineffective in removing COD (2%), however. Leersnyder attributes this to an initial deposition of oil-based forms of carbon followed by export of algal matter and plant detritus produced within the pond/wetland system.

Sampling of the bottom sediments of the pond revealed sharp gradients in metal, nutrient and hydrocarbon enrichment from the inlet to the outlet. Bottom sediments near the inlet structure were highly enriched with pollutants (23,956 mg/kg, 1,034 mg/kg, and 1,491 mg/kg of hydrocarbons, lead, and total phosphorus,

Figure 1: Plan View of Pacific Steel Pond (Leersnyder, 1993)

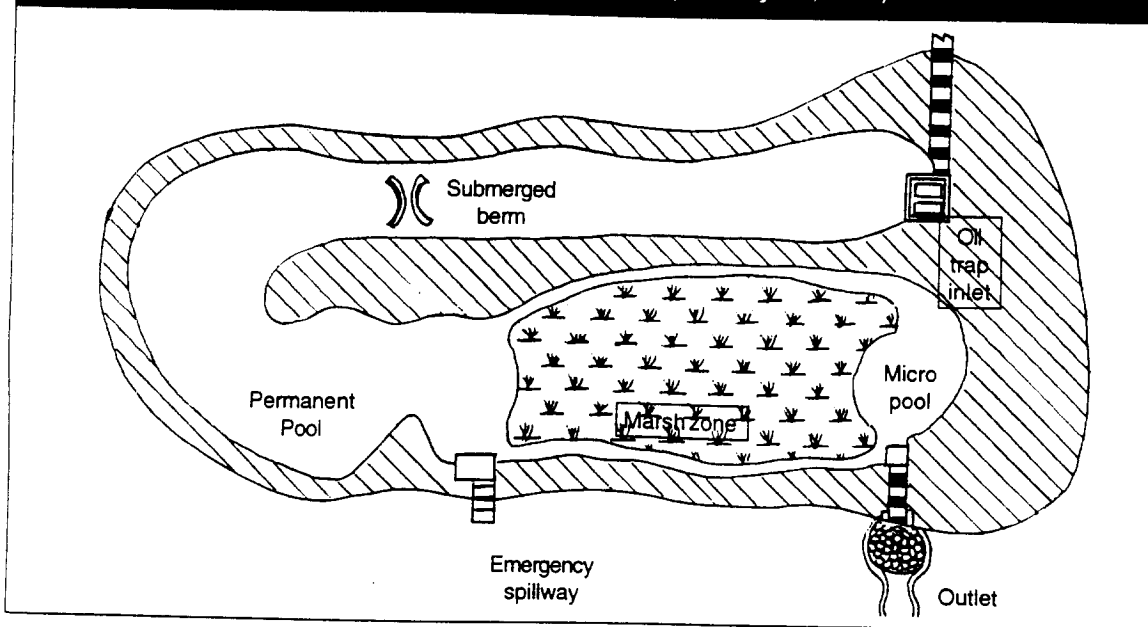

R0079862

**Table 1: Pollutant Removal Rates for Pond/Wetland System (Leersnyder, 1993)**

Parameter	Removal Rate (%)
Suspended Solids	78
Total Phosphorus	79
Sol. Reactive Phosphorus	75
Nitrate	62
Ammonia	43
COD	2
Total Copper	84
Total Lead	93
Total Zinc	88

*Percent mass reduction in six monitored storms in 1992*

respectively), but sediment concentrations declined by 80 to 97% at the outlet. The sharp gradient was consistent with Leersnyder's particle-size data, which indicated that most pollutants were attached to sediments deposited near the inlet.

Somewhat lower performance was reported for a second pond system located in a residential/commercial area of Auckland. While metal and sediment removal exceeded 60%, the removal of soluble reactive phosphorus (-42.7%), nitrate (28%) and ammonia (6%) was less than expected. The low nutrient removal was attributed to a high resident population of ducks, geese, and other waterfowl that lived on the pond.

The performance of the Pacific Steel pond/marsh system ranks among the highest yet reported for any pond system. This reflects not only the large treatment volume, but the system's excellent internal geometry, and the redundant treatment mechanisms of ponds and wetlands.

—TRS

**Reference**

Leersnyder, H. 1993. *Performance of Wet Detention for the Removal of Urban Stormwater Contaminants in the Auckland Region*. M.S. Thesis. Univ. of Auckland.



# Article 71

Technical Note #16 from *Watershed Protection Techniques*, 1(2): 64-68

## Performance of Stormwater Ponds and Wetlands in Winter

by Gary Oberts, Metropolitan Council, St. Paul, MN

Stormwater ponds and wetlands are common practices for treating stormwater runoff in northern regions. Until recently, however, very little winter monitoring data was available. Oberts and his colleagues sampled four stormwater ponds in Minnesota during both rainfall and snowmelt conditions (Oberts *et al.*, 1989). They found that ponds were generally effective in removing pollutants during non-winter conditions. However, there was a marked reduction in the performance of stormwater ponds in treating snowmelt runoff. Most ponds did a fair job of removing sediment and organic matter in the winter, but were mediocre at removing nutrients and lead (Figure 1).

There are several reasons for the poor performance of stormwater ponds in winter. One primary reason is the thick ice layer that can form, sometimes reaching three feet in depth. This ice layer can effectively eliminate as much as half of the permanent storage volume needed for effective treatment of incoming runoff. In this case, the first phase of meltwater runoff entering the pond plunged beneath the ice layer and created a turbulent, pressurized condition that scoured and resuspended bottom sediments in the pond.

Once the available pool volume under the ice was filled, meltwater runoff was forced to flow over the top

of the ice. This further reduced performance, since the settling depth above the impermeable ice layer was minimal. Pollutants that settled on the ice were easily resuspended during the next melt or runoff event. In addition to the physical limitations of settling, biological activity in the pond was also greatly reduced during the winter.

The same forces working against wet ponds in winter also work against wetland systems. In fact, wetland efficiency may drop even further because wetlands are shallower, have larger amounts of detritus available for re-suspension, and are biologically dormant during winter.

Research on a wetland in Minnesota shows how pollutants can pass through a stormwater wetland system, even when it appears as though the system might be working. The pollutant removal performance during snowmelt and for the first two rainfall events after snowmelt in a six-acre, six-chambered, lowhead wetland treatment system are presented in Figure 2. The wetland outlet was frozen for the entire winter and was thus effectively closed. This resulted in the formation of a thick ice layer and subsequent deposition and accumulation of all small midwinter events and base-flow in the final wetland chamber (approximately 2.5

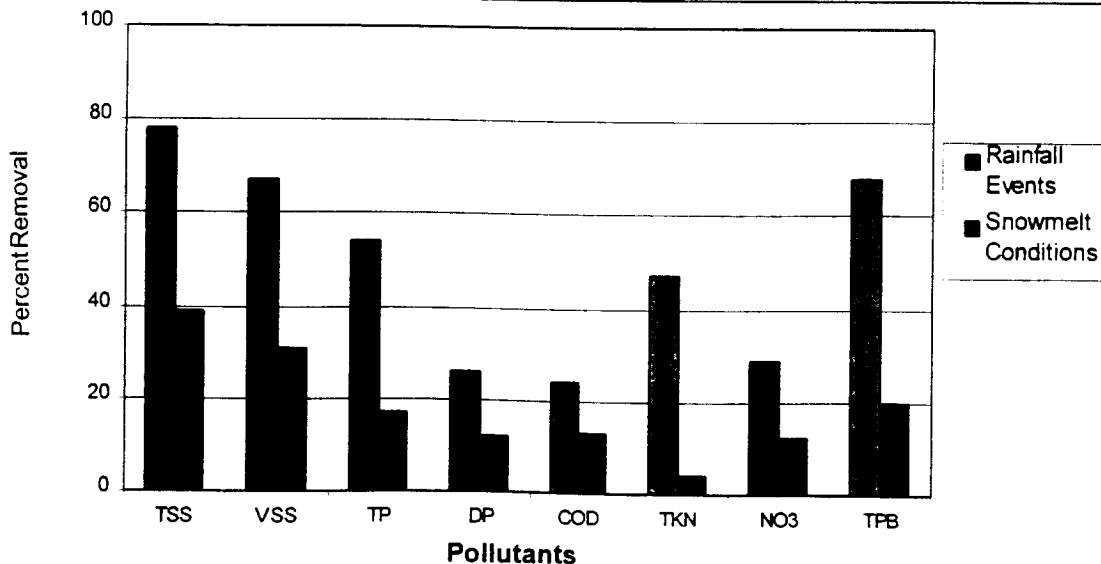

Figure 1: Average Effectiveness of Four Stormwater Ponds (Oberts *et al.*, 1989)

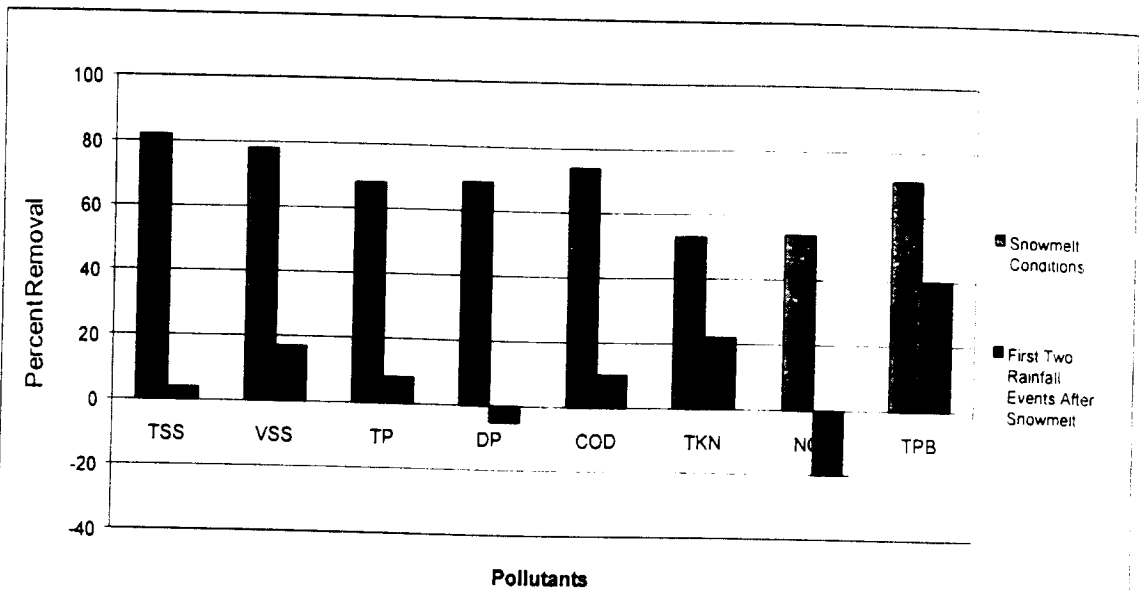

Figure 2: Effectiveness of a MN Stormwater Wetland in the Spring (Oberts and Osgood, 1988)

acres). When the end-of-season melt began, runoff entering the final wetland cell ponded and dropped a portion of its load on top of the ice layer. Water began to move downgrade only when an opening in the outlet culvert formed. The material that settled was subsequently washed away by the next rain that melted the snowpack entirely from the catchment.

**Are there design methods that can improve the performance of stormwater ponds during snowmelt conditions?**

*Meltwater Treatment*

The first meltwater from a snowpack will likely be acidic and highly concentrated with soluble pollutants, particularly ions ( $\text{Na}^+$ ,  $\text{Ca}^{2+}$ ,  $\text{SO}_4^{2-}$ ,  $\text{Mg}^{2+}$ ,  $\text{H}^+$ ,  $\text{NO}_3^-$ ). Adverse impacts of meltwater on aquatic life are typically related to elevated levels of metals, organic toxicants, and salt. Thus, meltwater treatment should occur before it reaches a receiving waterbody. One option is to detain it so that it can infiltrate into the soil where soil adsorption and macrobiotic activity can occur (Zapf-Gilje *et al.*, 1986).

Hartsoe (1993) found that PAHs were essentially non-detectable in groundwater infiltrating through sand and gravel at a highway drainage infiltration pond in Minnesota. However, the most soluble meltwater pollutants, such as chloride, will likely pass through the soil relatively intact. This phenomenon should be taken into account when designing a pond.

Two alternatives for meltwater treatment are shown in Figures 3 and 4. The first option is a nonstructural approach wherein meltwater is routed through an infil-

tration swale (e.g., grass, sand/gravel) to a flow diffuser that spreads the meltwater over a naturally vegetated or wetland surface (Figure 3). Even though the vegetation is dormant, some benefit will occur because the area will likely be able to infiltrate some water. Caution must be exercised, however, since chlorides and other ions can adversely impact the grass or wetland areas and induce a shift to less desirable plant species.

Meltwater infiltration can also be accomplished using a gravel level spreader that acts as a diversion channel. This simple feature can be incorporated into many different kinds of meltwater handling systems. The diversion channel can be used to route highly concentrated water around a particularly sensitive receiving water or into a best management practice.

The second option for meltwater treatment is an infiltration-detention basin that incorporates two design features to enhance meltwater treatment (Figure 4). The first feature is a variable outflow control structure that allows for drawdown of the water level to increase runoff storage. The second feature is an underdrain with a control valve to drain the porous bottom substrate in the fall. The goal is to decrease the moisture levels that lead to an impermeable layer of frozen soil.

Both the underdrain and outflow controls should be closed prior to the spring melt in preparation for runoff treatment. Once the melt begins, the initial function of the basin is to promote the infiltration of the "first flush" of meltwater. As the melt event proceeds and reaches its peak end-of-season flow, the basin acts as a detention facility, since inflow to the pond will exceed the infiltration capacity of the soil. Critical design features include the underdrain, the relatively flat slopes, soil

type, and the predicted end-of-season snowmelt volumes that will discharge into the basin.

Local groundwater quality must be considered since the first meltwater entering the basin may contain soluble pollutants that could migrate through the soils. Even though a very large volume of meltwater enters the basin, the combination of added detention with enhanced infiltration may dampen the "shock" effect of the highly concentrated first melt.

Additionally, the available storage helps to settle some of the particulate pollutants that leave the snowpack last. A basin of this type requires active management to assure desired infiltration capabilities are maintained and to regulate storage and soil conditions.

#### Seasonal Stormwater Ponds

A conceptual design for a "seasonal" pond that might overcome ice layer problems is shown in Figure 5. Water is drawn down in the fall from the pond to prevent the formation of a layer of ice at the normal summer elevation.

A low-flow channel discourages the formation of channel ice. The channel, which must have a high velocity, helps move baseflow and small melt through the pond during the winter and prevent ice buildup. As the melt progresses and meltwater flows increase, the lower outlets are closed, allowing the pond to again act

as a normal detention pond, capable of impounding water to summer design levels.

#### Other Pond Design Considerations

When drawdown is not possible or desirable, there are still some design options to improve the winter performance of stormwater ponds. First, the pond bottom should be sloped so that the deepest part is near the outlet. This configuration minimizes scouring of bottom material as water emerges from under the ice on its way out of the pond. Installation of a baffle weir, floatable skimmer, or a riser hood around the outlet can also help keep a constant movement of water below the ice, thus preventing the buildup of ice at the outlet. These measures assure that the outlet remains clear in the winter and can partially reduce the upwelling pressure of runoff from below the ice layer.

If an ice layer is unavoidable, the outflow device can be totally closed to allow for some detention capacity between the ice layer and the spillway elevation. Overflow can occur via an emergency spillway, provided adequate safety and erosion control measures are taken. Another approach to dealing with ice cover is to prevent its formation through aeration or circulation. This practice can be a safety problem, however, if the public has access to the facility. Thus, aeration or circulation should only be used if safety can be assured.

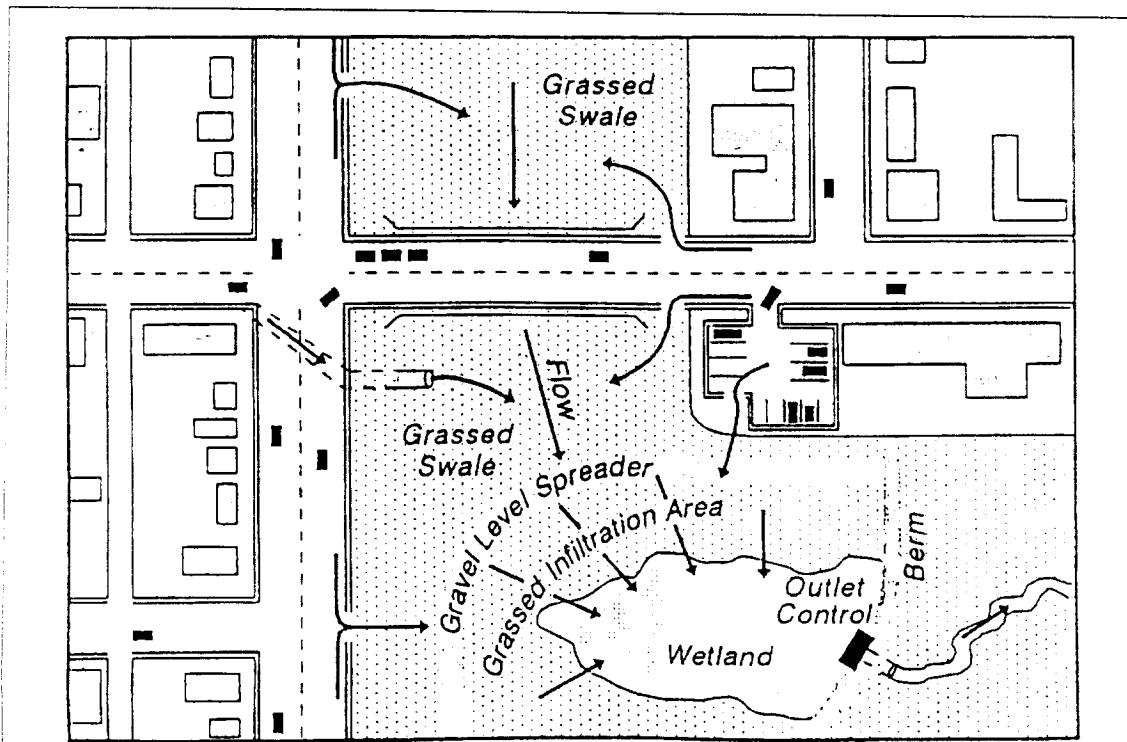

Figure 3: Minimum Structural Approach to Meltwater Treatment

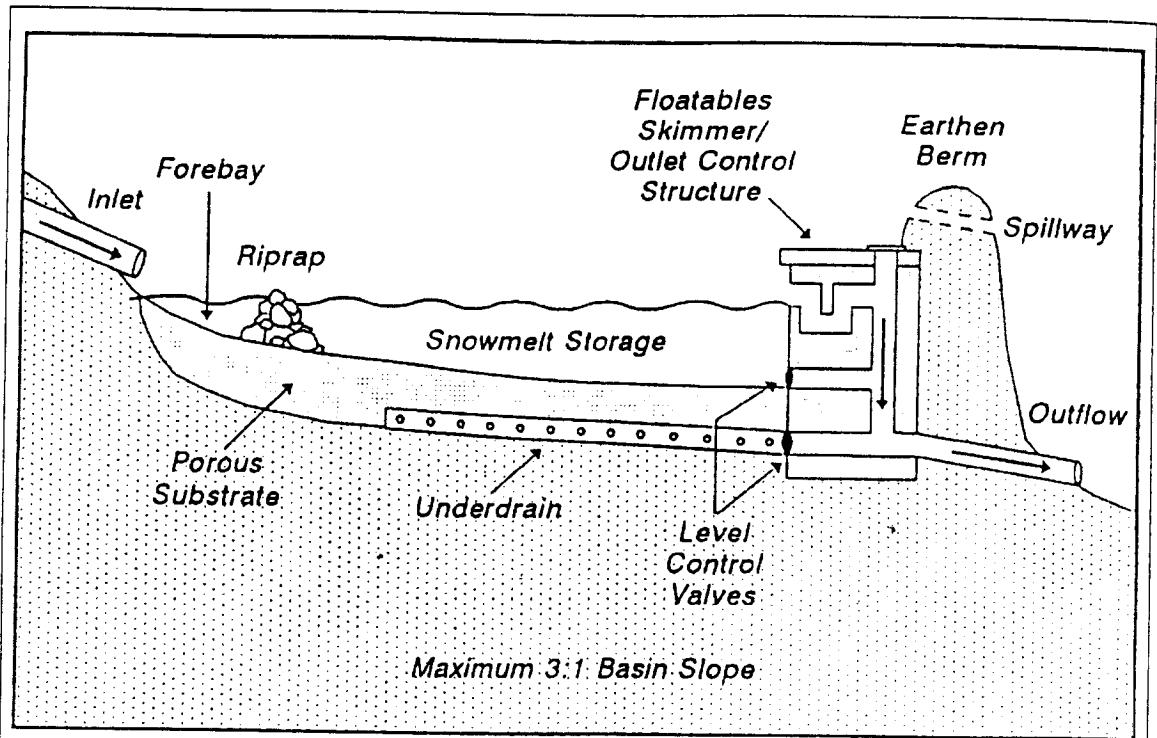

Figure 4: Combined Infiltration/Detention Basin

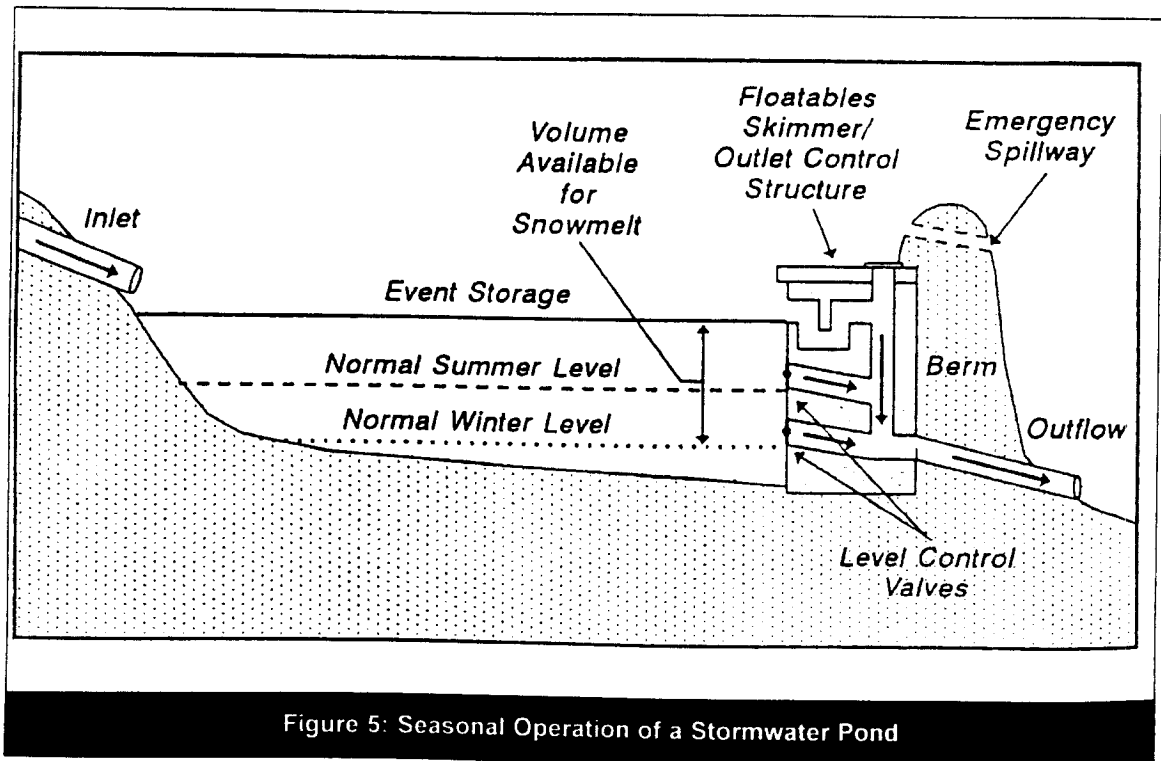

Figure 5: Seasonal Operation of a Stormwater Pond

Other problems are often encountered in the winter months. Ice can form a barrier that interferes with proper flow through the conveyance system. Frozen culverts are a very common occurrence, especially when water velocity is not sufficient to keep water moving, or when splash occurs, which slowly builds a thick layer of ice.

The use of moving parts in stormwater ponds should be carefully scrutinized because of the potential for freeze-up at the time when they are most expected to function (plates/gates, flashboards, valves, or similar controls). Orifice or weir outlet control may be used as an alternative. For example, if a pond is scheduled to be drawn down in the fall, and there is concern that a movable control valve will freeze in winter, an inserted flashboard or a bolted metal plate over an orifice could be used.

Warm weather methods of treating stormwater need to be adapted to more effectively handle pollutants during snowmelt. Useful approaches include seasonal detention facilities, specially designed outlet structures, meltwater infiltration, off-channel diversion, and aeration/circulation. See also articles 3 and 75.

## References

- Hartsoe, J.A. 1993. *The Groundwater Impact of Polycyclic Aromatic Hydrocarbons From Infiltrating Highway Runoff*. Met. Council, St. Paul, MN. Publ. No. 590-93-036. 88 pp.
- Oberts, G.L. and R.A. Osgood. 1988. *Lake McCarrons Wetland Treatment System: Final Report on the Function of the Wetland Treatment System and the Impacts on Lake McCarrons*. Met. Council. St. Paul, MN. Publ. No. 590-88-095. 227 pp.
- Oberts, G.L., P.J. Wotzka and J.A. Hartsoe. 1989. *The Water Quality Performance of Select Urban Runoff Treatment Systems*. Met. Council, St. Paul, MN. Publ. No. 590-89-062a. 170 pp.
- Zapf-Gilje, R., S.O. Russell and D.S. Mavinic. 1986. "Concentration of Impurities During Melting Snow Made From Secondary Sewage Effluent." *Water Science and Technology*. 18:151-156.

# Performance of a Stormwater Pond/Wetland System in Colorado

Urbonas and his colleagues recently investigated the pollutant removal performance of a large stormwater pond/wetland system located in Aurora, Colorado. The unique runoff treatment system is illustrated in Figure 1. Runoff enters a large wet pond that provided a total of 0.3 watershed-inches of runoff treatment (0.1 inches of permanent pool, plus 0.2 inches of extended detention — approximately 20 hours for most storm events). Runoff then exits the pond over a soil/cement spillway and enters a series of six cascading wetlands cells.

Wetland cells were located in a flat and broad channel, and were formed by a soil/cement drop structure installed across the channel. Water velocity was designed to be less than three feet per second (fps) during major floods, and less than 0.3 fps during smaller storm events. The wetland consisted primarily of cattail and bulrush species. Average contact time in the 3.8 acre wetland area was about two hours during smaller storms. The wetland cells comprised about 0.7% of total watershed area.

The Shop Creek watershed draining to the system was 550 acres in size and almost exclusively composed of detached single family homes. Watershed imperviousness averaged 40%, although only 75% of the

impervious surfaces were hydraulically connected. Shop Creek is located in the high plains and foothills of the Rockies mountains east of Denver.

Thirty-six storm events were sampled over a three year period in a cooperative effort of the Cherry Basin Water Quality Authority and the Denver Urban Drainage and Flood Control District. Monitoring was confined to the growing season (May to September) in the semi-arid area. In addition, a limited number of baseflow samples were taken along the wet pond and wetland system to characterize water quality dynamics during dry weather periods.

The monitoring revealed that the pond/wetland system was reasonably effective at removing many pollutants during storm events (Table 1). For example, about half of the total and dissolved phosphorus load was removed as it passed through the pond, with the majority occurring in the pond rather than the wetland. Likewise, about 72% of suspended sediment was removed by the system, even with a slight export from the wetland component. Removal of total zinc and copper approached 60% for the system. Chemical oxygen demand (COD) was reduced by 56%.

The performance of the pond/wetland system in removing nitrogen, however, was mediocre, due in

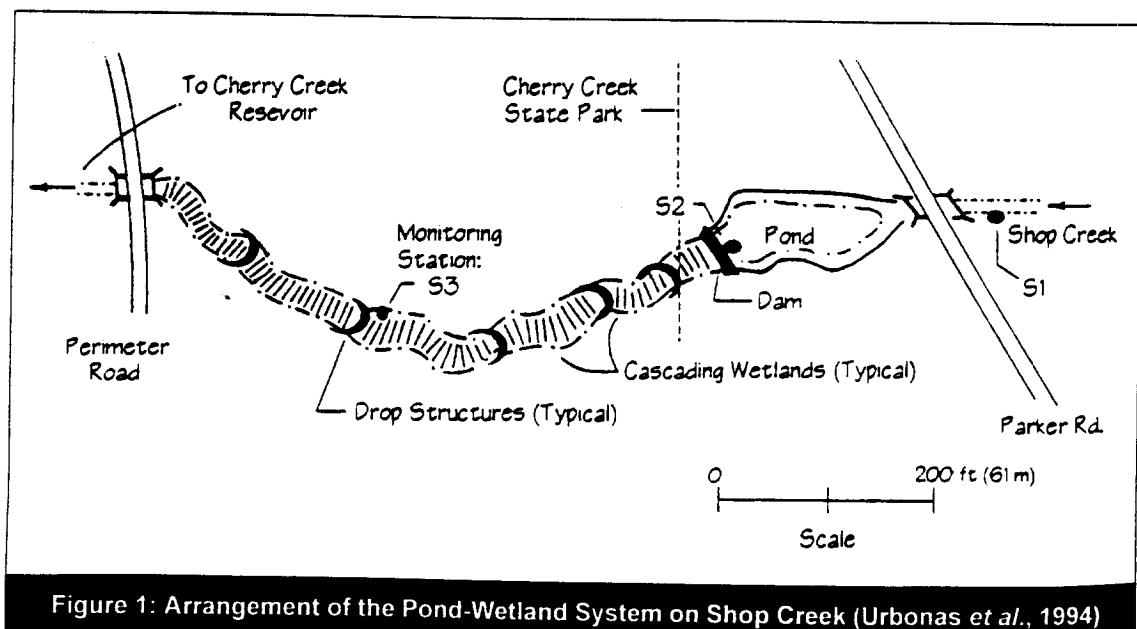

Figure 1: Arrangement of the Pond-Wetland System on Shop Creek (Urbonas *et al.*, 1994)



most part to a large export of nitrate (76%) and to a lesser degree, nitrite. The modest removal of organic forms of nitrogen (30%) could not offset this export of nitrate, which may have been caused by a large resident waterfowl population. In general, the combined system worked effectively, with the extended detention wet pond providing the bulk of the storm removal. The cascading wetlands helping to polish the quality of runoff during baseflow periods.

The importance of the wetland component was most evident during baseflow periods (Table 2). During these dry weather periods, the pond tended to export some pollutants due to biological activity and other processes (e.g., total copper, total iron, total phosphorus, organic nitrogen, and suspended solids).

The slight export of pollutants from the pond was generally compensated by further pollutant removal within the wetland component during dry weather periods. The only exception to this pattern was total copper, which increased by 110% as it passed through both portions of the system.

In summary, the long-term monitoring of the Shop Creek pond/wetland system indicates the importance of assessing pollutant removal during both storm and dry weather periods. The common practice of neglecting baseflow when pollutant removal efficiencies are computed is not a wise idea on pond systems that serve large drainage areas.

The study also supports the trend toward design of multiple and redundant stormwater treatment systems to provide more reliable pollutant removal over a range of runoff conditions.

—TRS

**Table 1: Average Removal Rates for the Pond/Wetland System During Storms, 1990-1992 (Urbonas et al., 1994)**

Parameter	% Removed by Pond	% Removed by Wetland	% Removed by System
Total Phosphorus	49	3	51
Dissolved Phosphorus	32	12	40
Nitrate-Nitrogen	-85	5	-76
Organic-Nitrogen	32	-1	31
Total Nitrogen	-12	1	19
Total Copper	57	2	57
Dissolved Copper	53	-1	58
Total Zinc	51	31	66
Dissolved Zinc	34	-5	30
Total Suspended Solids	78	-29	72
Chemical Oxygen Demand	44	21	56

#### Reference

Urbonas, B., J. Carlson, and B. Vang. 1994. *Joint Pond-Wetland System in Colorado, USA*. An Internal Report of the Denver Urban Drainage and Flood Control District.

**Table 2: Baseflow Water Chemistry Through the Shop Creek Pond/Wetland System (N=5)**

Parameter	Baseflow to Pond	Baseflow from Pond	Baseflow from Wetland	Storm Outflow *
Total Phosphorus (mg/l)	0.11	0.19	0.09	0.20
Dissolved Phosphorus (mg/l)	0.095	0.047	0.07	0.13
Nitrate-N (mg/l)	0.71	0.32	0.22	2.2
Total Copper (µg/l)	15	28	32	15
Dissolved Zinc (µg/l)	15	8	6	32
TSS (mg/l)	7	26	6	33
COD (mg/l)	19	56	24	36

\* Average concentration of storm outflow from pond-wetland system

# Article 73

Technical Note #63 from *Watershed Protection Techniques*, 2(1): 296-297

## Performance of Two Wet Ponds in the Piedmont of North Carolina

**H**ow much storage in a wet pond is enough? Some interesting answers to this questions have been addressed by researchers in North Carolina (Wu, 1989). They examined the performance of two very dissimilar wet ponds located in the piedmont near Charlotte, NC. The first wet pond, Lakeside, was large and deep and had a permanent pool volume equivalent to 7.1 watershed-inches (Table 1). To put this in perspective, this storage volume is seven to 15 times greater than that typically required for stormwater quality treatment in most communities in the US.

The second pond, known as Runaway Bay, was shallow (average depth 3.8 feet), and despite the fact that it served a 435-acre watershed, had a smaller surface area than the Lakeside pond. Indeed, when the perma-

nent pool volume of Runaway Bay was compared to Lakeside, it was found to be 20 times smaller (0.33 watershed inches of storage). The investigators examined the role of permanent pool volume on pollutant removal performance in these wet ponds.

Great performance was not expected for a number of reasons. To begin with, the two ponds were not originally designed for stormwater treatment. Each pond was fed by many inlet pipes, most of which were located near the outlet. Consequently, each pond experienced significant short-circuiting and was unable to delay downstream peak discharge by more than a few hours. Second, the soils in the watersheds were the trademark red clay soils of the Southern Piedmont.

An analysis of sediment particles in runoff showed that over 40% were less than three microns in diameter, and all were less than 26 microns (i.e. medium silt). As a result, the measured sediment settling velocity averaged less than an inch per hour, an uncommonly slow settling rate. Third, runoff concentrations of many pollutants produced from the two watersheds were quite low, when compared to those found in other cities and towns across the U.S. In particular, incoming runoff had relatively dilute concentrations of nitrogen and phosphorus. Monitoring of other ponds has often shown that pond performance declines when incoming pollutant concentrations are low. Lastly, one of the ponds (Lakeside) had its own internal nutrient loading source: a year-round population of 30 to 40 geese. Feeding on nearby turf, the geese were estimated to add some five to 7% to the pond's total nutrient load through droppings.

Wu and his colleagues monitored the performance of each pond during 11 storm events that ranged from 0.5 to 3.6 inches of rainfall. The results are shown in Table 2. As expected, the larger and deeper Lakeside pond performed better than the shallow and undersized Runaway Bay pond. Excellent removal of suspended sediment and some metals was observed at the Lakeside pond (greater than 80%). The performance of the larger Lakeside pond in removing nutrients, however, was surprisingly modest in comparison to the smaller Runaway Bay pond. Removal of phosphorus and nitrogen was only 10% higher at Lakeside, despite the fact that this pond had a permanent pool volume 20 times greater than Runaway Bay. Wu speculated that the population of geese at the Lakeside pond could

Table 1: Characteristics of the Study Ponds

Pond characteristic	Lakeside Pond	Runaway Bay
Drainage area (acres)	65	437
Imperviousness	46%	38%
Pond area (acres)	4.9	3.3
Mean depth (ft.)	7.9	3.8
Volume (acre-ft.)	38.8	12.30
Equivalent watershed storage (in.)	7.1	0.33
Resident geese	30 to 40	none

Table 2: Pollutant Removal of Two Wet Ponds in the North Carolina Piedmont (Mean storm efficiency N= 11)

Water quality parameter	Lakeside Pond (%)	Runaway Bay (%)
Total Suspended Solids	93	62
Total Phosphorus	45	36
Total Kjeldahl Nitrogen (TKN)	32	21
Extractable Zinc	80	32
Extractable Iron	87	52
Pond Area/Watershed Area	7.5	2.3

have reduced its efficiency. Short-circuiting and low inflow concentrations were also cited as reasons for the modest performance at the Lakeside pond.

Another interesting facet of the study was Wu's analysis of the outflow from the ponds under dry weather conditions. Dry weather outflow from ponds is generally not measured in most monitoring studies, nor is it accounted for when pond pollutant removal rates are computed. The standard assumption is that both the volume of total runoff and the concentration of pollutants in dry weather flow are inconsequential in relation to those produced during storm events. Wu's data suggests that this assumption may be a dubious one (Table 3). Levels of total phosphorus and organic nitrogen in the outflow from each pond was actually higher during dry weather periods than during storm conditions.

To get a better handle on the ideal permanent pool volume for wet pond design, Wu used an EPA model of wet pond pollutant removal performance, using local data on pond geometry, rainfall/runoff relationships and sediment settling velocities (EPA, 1987). Wu found generally good agreement between the model results and his field monitoring data, although the model tended to slightly underpredict nutrient removal rates. Based on his results, Wu recommended that satisfactory pollutant removal performance could be achieved if wet ponds were sized to be at least 2% of the contributing drainage area, with an average depth of six feet. The study also reinforces the notion that treatment volume

**Table 3: Comparison of Storm and Dry Weather Outflows From Lakeside (LS) and Runaway Bay (RB) Ponds**

Water quality parameter (mg/l)	Mean storm inflow	Mean storm outflow	Dry weather outflow
Total P (LS)	0.14	0.08	0.15
Total P (RB)	0.12	0.08	0.18
TKN (LS)	0.86	0.59	1.20
TKN (RB)	0.79	0.63	0.80

alone does not guarantee good performance. Other key design variables include providing good internal geometry and pondscaping to discourage large geese populations.

—TRS

**References**

Wu, J. 1989. *Evaluation of Detention Basin Performance in the Piedmont Region of North Carolina*. North Carolina Water Resources Research Institute. Report No. 89-248. Raleigh, NC. 46 pp.

U.S. EPA. 1987. *Methodology for Analysis of Detention Basins for Control of Urban Runoff Quality*. EPA 440/5/87-001. US EPA Washington, DC. 72 pp.



## Article 74

Technical Note #113 from *Watershed Protection Techniques*, 3(3): 717-720

# Performance of Stormwater Ponds in Central Texas

Is any more data on stormwater ponds really necessary? After all, the performance of nearly 40 stormwater ponds has been investigated over the last two decades. However, there are a few good reasons to acquire still more monitoring data on these stormwater workhorses. First, most of the stormwater ponds monitored in the past were relatively small in size and simple in design. Moreover, these ponds seldom possessed the forebays, aquatic benches, greater volumes, extended detention, pondscaping and other design features now routinely prescribed by many local stormwater agencies. It is thus of more than passing interest whether these new and often expensive features can actually improve the pollutant removal performance of ponds and by how much.

Second, most prior pond research has occurred on the coasts, and mostly within humid climates. Because of this, performance monitoring data has been lacking for stormwater ponds built in semi-arid climates that have very hot and dry summers and the accompanying high evaporation rates. Stormwater managers have frequently wondered whether it is possible to maintain a permanent pool and prevent stagnation in ponds within these regions, and how these factors might influence the pollutant removal capability and maintenance requirements of wet ponds.

Two recent monitoring studies conducted near Austin, Texas shed some light on both of these issues

(COA, 1997a; LCRA, 1997). While the Central Texas region typically gets about 30 to 35 inches of rainfall each year, it is not unusual for the region to go many weeks without rain during the summer, when evaporation rates are as high as 10 inches per month. As a consequence, significant pond draw downs must be factored into the design of stormwater ponds, or else they must be supported with supplemental water.

The first stormwater pond, known as St. Elmo's, had a permanent pool of 4.1 acre-feet. The pond served a 27.1 acre catchment that had more than 66% impervious cover, most of which was either street or parking lot. The surface area of the pond was 1.65 acres, with about 40% devoted to shallow wetlands, and 60% allocated for deeper pools. The layout and pondscaping plan for St. Elmo's are depicted in Figure 1. Forebays were located at the primary stormwater inlets, and berms were used to extend the flow path and prevent runoff from short-circuiting through the pond. The pond also provided extended detention storage above the pool, with a one to three day draw down time after a storm. Combined, the permanent pool and extended detention storage provided about 1.8 watershed-inches of storage quality treatment. Overall, the hydraulic retention time in the pond ranged from two to 70 days, with an average of about a month. Clearly, St. Elmo's was not an undersized pond.

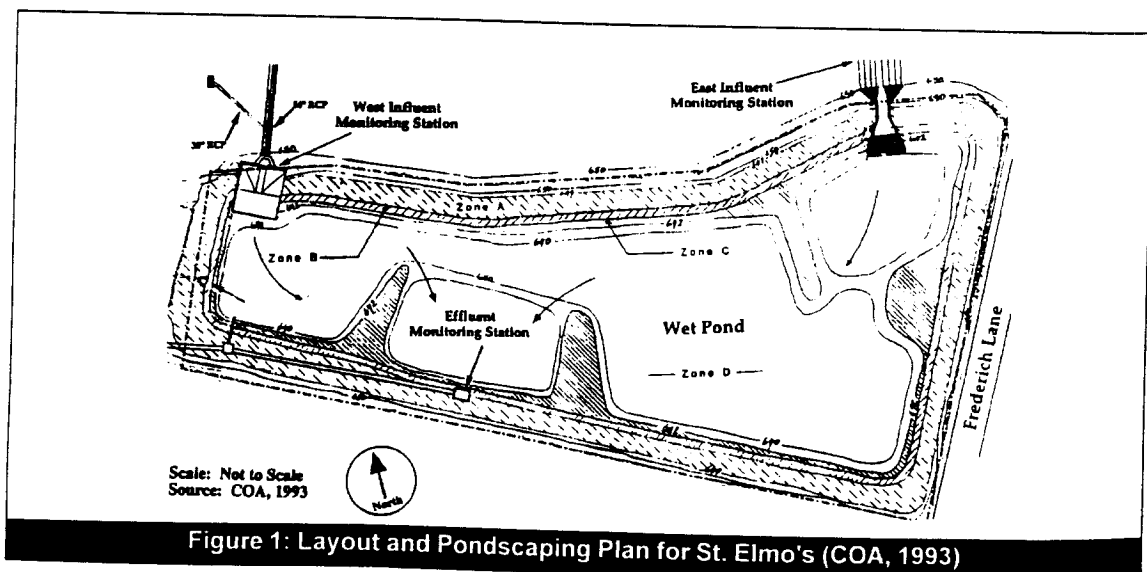

To prevent evaporation in the summer, the bottom of the pond was sealed by a liner. Still, evaporation made it difficult to maintain the pool at a constant level. To conceal changes in water levels, shallow areas in the pond were planted with spike rush (*Eleoarchis spp.*), Bulrush (*Scirpus*), Duck Potato (*Sagittaria*) and other aquatic plants. The pond was less than two years old when monitoring began in 1994, and more than 20 paired stormwater samples were collected at the inlets and outlet over the next two years. As usual, the monitoring effort and subsequent data analysis followed the exacting standards of the City of Austin Drainage Utility (COA, 1997a). The computed pollutant rates for the St. Elmo's wet pond are provided in Table 1.

It is evident that the St. Elmo wet pond provided a very high rate of pollutant removal, with more than 90% removal of total suspended solids and bacteria. Nutrient removal was also quite strong, with exceptional removal of total phosphorus (87%) and dissolved phosphorus (66%). Removal of various forms of nitrogen ranged from 40 to 90%, as well. However, the removal of metals was not as promising, ranging from 30 to 60%. Overall, the St. Elmo pond consistently achieved removal rates approximately 20% above the national median removal rates for wet ponds. A close inspection of the outflow from the pond revealed very low concentrations of most stormwater pollutants, which is another indicator of a high level of treatment (see Table 1).

A third indicator of the high level of stormwater treatment achieved by the St. Elmo pond was the high pollutant concentrations found in the sediments (Table 2). Despite the fact that the pond was only a few years old, its sediments had trace metal and hydrocarbon levels similar to those found in the sediments of Austin area oil/grit separators. The high level of stormwater treatment achieved at St. Elmo was attributed to its enhanced pond design features and large permanent pool. These resulted in unusually long hydraulic residence times that allowed settling, algal uptake and other pollutant removal processes to operate.

The second pond was a micropool extended detention pond monitored by Bruce Melton and Tom Curran of LCRA (1997). The pond drained roughly 12 acres of office park and roadway, and utilized a much different design concept than St. Elmo's. Most of the water quality storage provided in the pond (about one watershed-inch) was devoted to extended detention (ED), with only a small permanent pool located near the outlet (about 0.29 acre-feet). During dry weather, the pool was maintained by draining excess condensation water from the air-conditioning systems of the buildings in the office park. This supplied about 2.6 acre-feet per year of supplemental water needed to sustain the micropool, which had a fringe of wetland plants. The pond had two inlets, each of which had a forebay formed

by a rock or gabion berm to provide pretreatment. Some of the upland drainage was treated with other innovative peat sand filters.

The pond was extensively landscaped with a variety of drought and/or inundation tolerant plant species planted, depending on their elevation within the pond.

**Table 1: Performance of the St. Elmo Wet Pond System**

Water Quality Parameter	Outflow Concentration	Removal Efficiency
Total Suspended Solids--TSS	9 mg/l	93%
BOD, five day	2.4	61%
COD	23	50%
Nitrate-Nitrogen	0.45	40%
Total Kjeldahl Nitrogen	0.47	57%
Ammonia-Nitrogen	0.03	91%
Total Nitrogen	0.92	50%
Total Phosphorus	0.04	87%
Dissolved Phosphorus	0.03	66%
Copper	4.2 ug/l	58%
Lead	3.9 ug/l	39%
Zinc	59.6 ug/l	27%
Fecal Coliform	1324	98%
Fecal Strep	1265	96%

*For comparison purposes, the median removal rates for wet ponds was 77% (TSS), 47% (TP), 30% TN and 45% (Cu), according to CWP National STP Database (see article 69). Pollutant removal rates for trace metals were computed based on means of instantaneous individual inflow and outflow concentrations.*

**Table 2: Sediment Chemistry of St. Elmo Pond Sediment (mean of five sediment samples)**

Sediment Parameter	Units	Level
Lead	mg/kg	21.5
Zinc	mg/kg	471
Copper	mg/kg	46.7
Petroleum Hydrocarbons	mg/kg	5,202
Total Organic Carbon	mg/kg	4,414
PAH's (max)	ug/kg	10,210



A clay liner was installed to prevent infiltration losses, which failed initially and was subsequently repaired. Water levels in the pool were fairly stable, but did draw down during extended dry periods (which coincided, naturally, with the onset of the stormwater monitoring program). With some persistence, the research team was able to collect 17 paired storm samples at the inlet and outlet over a two-year period. Their estimates of the pollutant removal capability for the pond are provided in Table 3.

In general, the micropool extended detention pond performed quite well in removing most pollutants found in urban stormwater. Overall, the removal rates are generally higher than the national median removal rates for all stormwater ponds, and are the highest yet recorded for a pond that devoted most of its treatment volume to extended detention. The micropool ED pond removed roughly half of the total nitrogen and phosphorus in incoming runoff, and produced very low concentrations of all forms of nutrients in its outflows (see Table 3). Removal of sediment and trace metals was greater than 80% in the pond.

#### *Implications for Stormwater Design*

The strong nutrient removal performance in both ponds was promoted by the long growing season and bright sunshine for which Central Texas is noted. Both ponds were rapidly overgrown with surface and benthic algae, emergent plants and submerged aquatics. As much as 70 to 80% of the surface area of each pond was covered by these aquatic plants, which undoubtedly led to the high removal. At the same time, the high rate

of plant growth added to the annual maintenance burden, as some form of aquatic plant management or harvesting was needed to keep each pond looking attractive. The role of evaporation, while not directly studied, was thought to be very important in the pollutant removal performance of the ponds.

Glick *et al.* (1998) noted that the monitoring studies clearly demonstrated that wet ponds exhibit greater pollutant removal than other stormwater practices in Austin, Texas, at a lower cost per volume treated than other practices, such as sand filtration. Consequently, the City has developed new specifications for wet ponds and actively promote their use (COA, 1997b).

In many instances, wet ponds can require supplemental water to maintain a stable pool elevation during dry periods in Central Texas. Consequently, designers need to explore innovative means of recycling other sources of water to maintain pools. Otherwise, designers working in semi-arid watersheds should design for a variable pool level that can have as much as a three-foot draw down during the dry season. The use of wetland plants along the pond's shoreline margin can help conceal these drops in water level, but managers will need to reconcile themselves to chronic algal blooms, high densities of aquatic plants and the occasional episode of odor problems. Thus, the price for attaining higher pollutant removal in ponds in Central Texas is often supplementary source of water and certainly a greater effort to maintain aquatic vegetation. -TRS

Table 3: Performance of the LCRA Office Wet Extended Detention Pond (LCRA, 1997)

Water Quality Parameter	Outflow Concentration (mg/l)	Removal Efficiency (%) <sup>a</sup>
Total Suspended Solids	12.0	83
Total Organic Carbon	8.7	45
Total Phosphorus	0.11	52
Ortho-phosphorus	0.034	76
Nitrate-nitrogen	0.06	85
Total Kjeldahl Nitrogen (TKN)	0.69	52
Total Nitrogen	0.77	55
Lead	0.003	90
Zinc	0.030	86

(a) removal computed based on average event mean concentration (EMC) from 17 storms at inlet and outlet of basin. (b) removal for Cadmium and Chromium could not be computed because most samples were below detection limits.

**References**

City of Austin (COA). 1997a. *Evaluation of Nonpoint Source Controls— An EPA/TNRCC Section 319 Grant Report*. Drainage Utility Department. Report No. COA-ERM-97-04. Austin, TX. 130 pp.

City of Austin, (COA) 1997b. "Wet Pond Design Supplement." Section 1.6.6.C of *Environmental Criteria Manual*. City of Austin, TX Drainage Utility.

Glick, R., G. Chang, and M. Barret. 1998. *Monitoring and Evaluation of Stormwater Quality Control Basins*. Water Environment Federation Speciality Conference. Proceedings. Watershed Management: Moving from Theory to Implementation. Denver, CO. May 3-6, 1998.

Lower Colorado River Authority (LCRA), 1997. *Final Report: Innovative NPS Pollution Program for Lake Travis in Central Texas*. Prepared for Environmental Protection Agency and the Texas Natural Resource Conservation Committee. Contract No. 1900000019. 60 pp.

**Profile of the St. Elmo Wet Pond Showing Landscaping Zones (COA, 1993)**

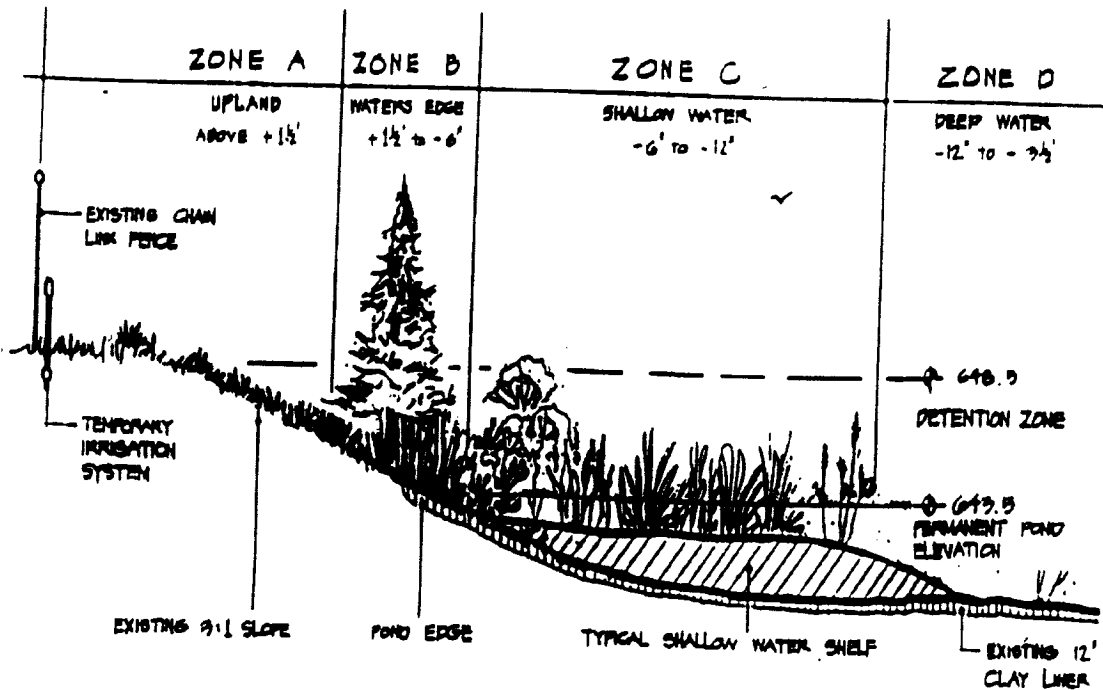

## Article 75

Technical Note #114 from *Watershed Protection Techniques*, 3(3): 721-728

# Pollutant Removal Dynamics of Three Canadian Wet Ponds

Communities in the Toronto metropolitan area have long relied on wet ponds and wet extended detention ponds to treat stormwater runoff from new development. According to provincial guidelines, wet ponds are sized based on two primary factors: the quality of fishery habitat present downstream (designated as fishery level one through four) and the amount of impervious cover present in the upstream catchment (OME, 1994). Based on these factors, engineers must achieve a numeric target for suspended sediment removal in the stormwater pond to protect the downstream fishery habitat (Table 1). The Ontario approach for sizing ponds results in wet ponds that often have more water quality storage than many of their American counterparts, given that many Ontario watersheds still contain high quality fishery habitat.

Over the last five years, a consortium of local and provincial stormwater agencies have investigated how various kinds of ponds perform under the demanding climatic conditions of the Toronto metropolitan region. This research program, known as the Stormwater Assessment Monitoring and Performance Program (SWAMP), has added greatly to our understanding of how modern ponds remove stormwater pollutants during both the summer and winter in northern latitudes.

The SWAMP study is also notable because it commissioned a series of supplemental research studies to investigate the internal dynamics of stormwater ponds. These studies included monitoring wetland plant colonization over time, sediment deposition rates, sediment quality, the impact of chlorides from road salts, and the impact of ponds on stream warming. With apologies to our Canadian friends, we confess to being metrically challenged, and have converted some of their metric data into American units for the convenience of our stateside readers.

The basic design utilized in the SWAMP program involved sampling three ponds during both the growing season and more demanding wintertime conditions. Automated flow and water quality samplers were located at the inlet(s) and outlets from each pond during the summer and fall. Due to ice cover, grab samples of pollutant concentrations were collected at inlets and outlets to characterize how the ponds influenced pollutant concentrations during winter and snow melt conditions. Each of the three ponds selected for intensive monitoring employed several innovative pond design concepts, such as sediment forebays, extended detention over the permanent pool, generous water quality storage volumes, reverse-sloped pipes, multiple cells,

Table 1: Sizing Guidelines for Wet Ponds in Ontario (OME, 1994)

Watershed Protection Level	Required water quality storage for Ontario wet ponds (inches per acre)			
	35% imp	55% imp	70% imp	85% imp
Level 1 fishery (excellent habitat) 80% sediment removal	0.56	0.76	0.90	1.0
Level 2 fishery (good habitat) 70% sediment removal	0.36	0.44	0.52	0.60
Level 3 fishery (poor habitat) 60% sediment removal	0.24	0.30	0.34	0.38
Level 4 retrofit and redevelopment 50% sediment removal	0.24	0.24	0.24	0.26

Note: Indicated storage is allocated to permanent pool, except up to 0.16 inches which can be supplied as extended detention storage.



or ideal pond geometry (although not all of these design factors were incorporated into every pond).

#### Heritage Estates Wet Pond

The first pond investigated by the SWAMP program was a basic wet pond known as Heritage Estates (Liang and Thompson, 1996) (see Figure 1). The pond served a 130-acre residential catchment that had estimated impervious cover of 50%. Designed for Level 2 protection, the wet pond was a pool that provided 0.51 watershed-inches of storage. The pond was relatively shallow (about three to four feet in depth) and had a surface area of 1.85 acres (or about 1.4% of watershed area). The pond did not provide any storage for extended detention, but did provide control for the five-year storm. The pond was seven years old when monitoring began, and had two inlets, but no forebay. The outlet structure of the Heritage Estates pond was a rectangular weir discharging water from the surface of the pond.

The pond froze over during the winter months, and often had eight to 12 inches of ice cover. The roads in the catchment were heavily sanded and salted during the winter months, but were swept in the early spring, and monthly thereafter. The study team was able to monitor more than 20 storm events at Heritage Estates, with half of the samples obtained during the growing season, and the remainder collected during winter or spring snow melt conditions.

#### Harding Park Wet Extended Detention Pond With Wetland

The second pond, known as Harding Park, was a retrofit, and was much more complex in its design (see Figure 2). Harding Park had three cells, including a shallow forebay, a six-foot deep permanent pool and a small wetland. In addition, extended detention storage was provided above each cell. The pond was designed for Level 2 protection, and contained about 0.66 watershed-inches of water quality storage. About two-thirds of its water quality storage was devoted to extended detention, with the remaining third allocated to a small permanent pool (about 0.22 inches). The average detention time achieved by the pond was not ideal, averaging about six to 12 hours for most storm events.

The Harding Park pond served a 42-acre residential catchment that was estimated to be 45% impervious. The entire facility had a surface area of 1.7 acres (or about 4% of the watershed area). The retrofit, which was only one year old when monitoring began, encountered some early operational problems. A berm which separated the pond and the small wetland collapsed shortly after construction and was not repaired for many months. Consequently, the first year of monitoring data could not be used. Still, the SWAMP study team was able to collect more than 20 storm samples after the berm was

repaired. Once again, half of the storm samples were collected in the growing season, and the remaining half were collected under winter and spring snow melt conditions (SWAMP, 2000b).

#### Rouge River Wet Extended Detention Pond

The last pond that was monitored was a wet extended detention pond, known as the Rouge River Pond. Designed for Level 1 protection, the retrofit pond served a 320-acre catchment that was dominated by some of the more heavily traveled roads in the Toronto

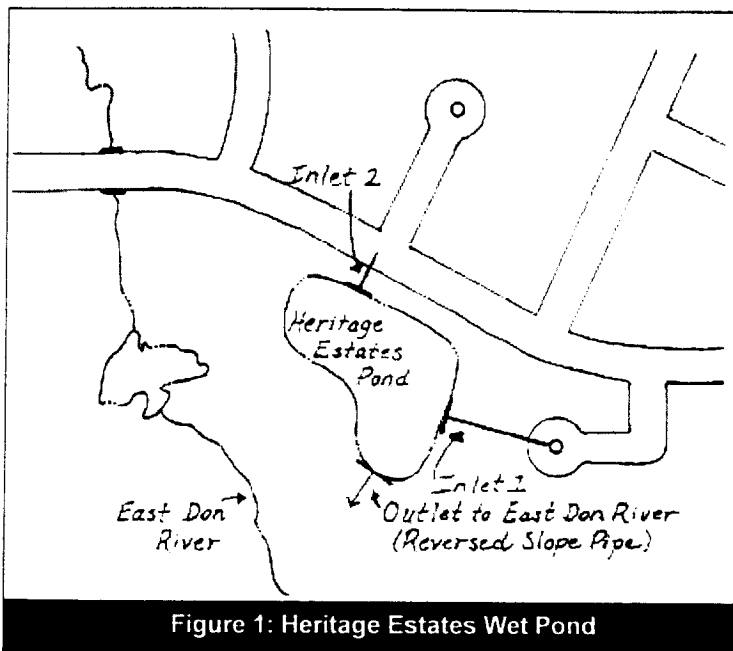

Figure 1: Heritage Estates Wet Pond

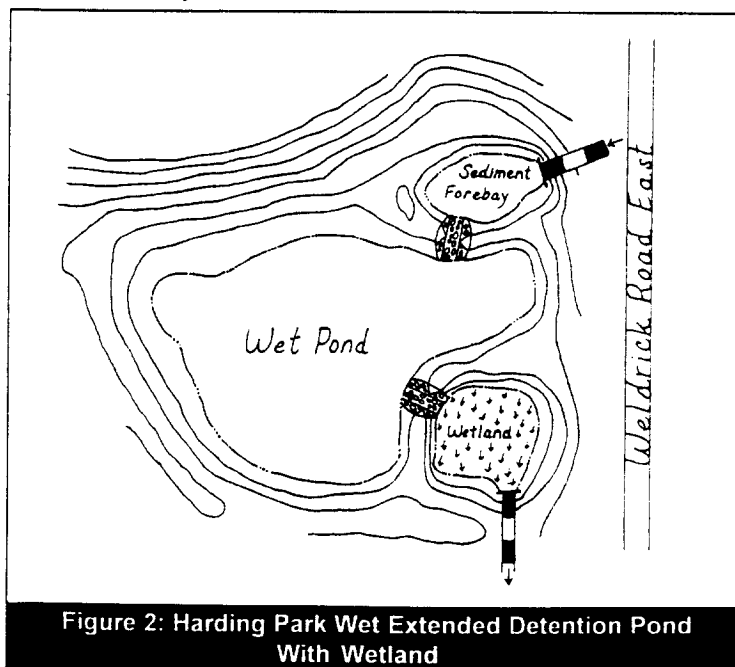

Figure 2: Harding Park Wet Extended Detention Pond With Wetland

region. The catchment also included some residential development, and was estimated to be 60% impervious. The retrofit pond provided a total of 0.64 watershed-inches of water quality storage, which was equally split between the permanent pool and extended detention. Linear in shape, the pond had an extraordinary length to width ratio of ten to one (see Figure 3). The wet pond was quite deep (eight foot average depth), and was equipped with a reverse slope pipe outlet that withdrew water about three feet below the normal pool. The pond also had a sediment forebay at its single inlet that comprised about 15% of the total water quality storage for the pond. The retrofit was also equipped with a flow splitter to bypass all storm flows that exceeded the two-year storm event around the facility (SWAMP, 2000a).

The pond was less than two years old when monitoring began, and several early problems were encountered. The sediment forebay was completely filled shortly after construction, and the main pond cell experienced very high turbidity, as a result of sediment loads from upstream roadway construction and severe bank erosion. Sampling commenced after the forebay was dredged and upstream erosion problems were stabilized, and the SWAMP team collected 18 storm events after these problems were corrected.

### Comparative Performance of the Three Canadian Stormwater Ponds

#### *Pollutant Removal During the Growing Season*

The comparative capability of the three stormwater ponds to remove stormwater pollutants during the growing season is presented in Table 2. As can be seen, all of the ponds were able to remove most urban pollutants at a reasonably high level. For example, each of the ponds was able to remove at least 80% of the incoming

suspended sediment load during the growing season, which met or exceeds provincial guidelines for sediment removal. Indeed, particle size analysis conducted at two of the ponds indicated that they were effective in removing most particles larger than 10 microns.

The results were more mixed for nutrient removal. Each of the three ponds did an exceptional job of removing soluble phosphorus (range 69% to 91%), and two of the three ponds averaged about 80% for total phosphorus, as well. A high rate of phosphorus removal in the ponds was also indicated by the very low phosphorus concentrations measured at the pond outlets (see Table 4). On the other hand, the three ponds showed a much lower ability to remove nitrogen from stormwater. While each pond was capable of removing a modest amount of nitrate-nitrogen due to algal uptake, the removal of organic nitrogen was low, and in some cases, negative. Overall, removal of total nitrogen ranged from about 15 to 40% in the three ponds.

Each of the ponds was reasonably effective in removing total copper, lead and zinc, but was not very effective in removing cadmium from stormwater runoff. The study also measured the ability of the ponds to remove many trace elements not frequently monitored by other investigators. Removal rates of 50% or greater were consistently attained during the growing season for aluminum, beryllium, chromium, cobalt, iron, nickel and vanadium at each of the ponds. In contrast, low or negative removal rates were routinely reported for barium, calcium, magnesium, silicon, strontium and titanium. The ponds were also found to have a moderate to high ability to remove oil and grease and pentachlorophenol from stormwater runoff (the latter are associated with the use of wood preservatives).

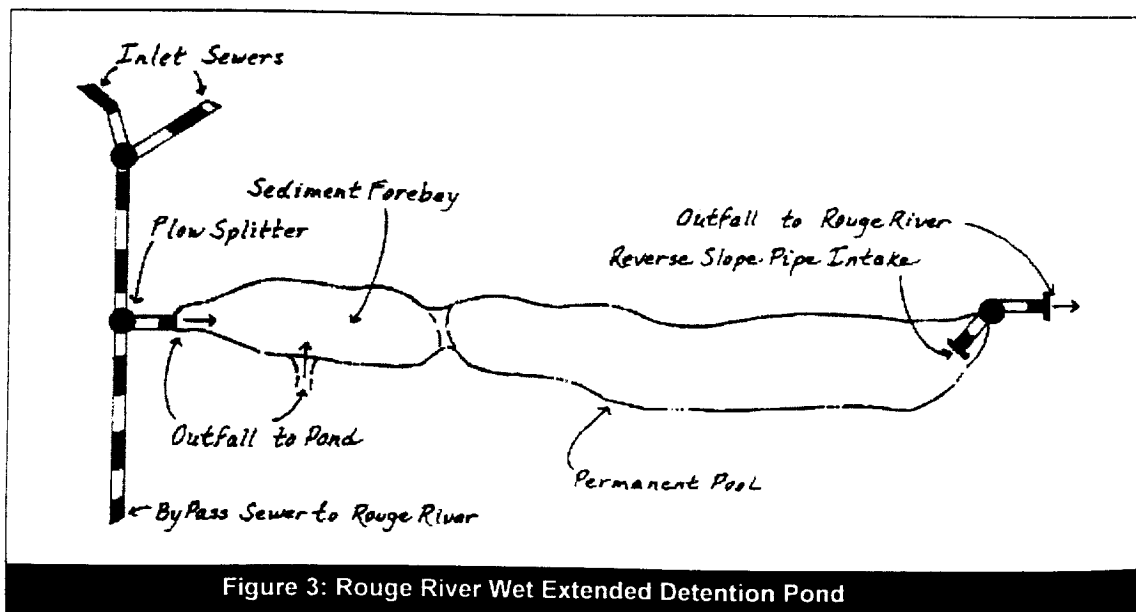

Figure 3: Rouge River Wet Extended Detention Pond

The ponds showed some promise in removing bacteria, with 50 to 90% removal reported for fecal coliform and *E. coli* during the growing season. Even at this level of stormwater treatment, however, outflow concentrations were typically five to 10 times above bacteria standards (see Table 4). The study team also discovered that dissolved inorganic carbon (DIC) and chlorides were exported from each of the ponds during the growing season. The export of chlorides was thought to reflect the gradual release of dissolved salts that had entered the pond during the winter as a result of road deicing.

The study team conducted a series of bioassays to determine if one of the ponds (Rouge River) could reduce potential toxicity of stormwater for zooplankton and trout test organisms. Most of the bioassays indicated that the stormwater entering and leaving the pond was non-lethal. A few bioassays caused mortality, which was primarily attributed to high chloride and copper concentrations. The Rouge River pond did appear to reduce copper concentrations to non-lethal levels, but had little effect on chloride levels.

#### Pollutant Removal During Winter Conditions

A key study objective was to characterize how the ponds worked during snow melt conditions in the winter. This effort was limited by the unavoidable problem of collecting grab samples of pollutant concentrations, since ice cover prevented the team from collecting reliable flow measurements in the winter. Still, the SWAMP team was able to collect more than 30 samples at the three ponds.

Overall, winter removal rates were surprisingly high, and were almost as great as those observed during the growing season (Table 3). Sediment removal ranged from 75 to 86%. Nutrient removal was slightly lower, which was expected given the lack of biological uptake in the winter. Still, average phosphorus removal ranged from 56 to 67%, and TKN removal was about 30%, as well. Slightly negative removal was reported for soluble forms of nitrogen. The concentration of total phosphorus and total nitrogen in pond effluent was typically 30 to 50% higher in winter than in the growing season. Removal of copper, lead and zinc also tended to be slightly lower in the winter months than during the

**Table 2: Comparative Pollutant Load Reduction at Three Ontario Stormwater Ponds During Growing Season**

Parameter <sup>1</sup>	Heritage Park Wet Pond	Harding Park Wet ED Pond w/marsh	Rouge River Wet ED Pond
Total Suspended Solids	80%	80%	87%
Total Phosphorus	80	37	79
Ortho-phosphorus	91	87	69
Nitrate-nitrogen	62 <sup>2</sup>	29	24
TKN	0	(-24)	59
Ammonium	(-68)	(-24)	70
Cadmium	10	0	46
Copper	70	41	79
Lead	15	84	84
Zinc	68	69	79
Fecal Coliform	90	64	ns
<i>E. Coli</i>	86	51	ns
Chloride	(-188)	(-545)	(-169)
Pentachlorophenol	80	ns	46
Oil/Grease	ns	37	79

Notes: 1. Growing season removal based on 10 or more paired samples at each pond.  
 2. Nitrate removal calculated using average mean concentration methods  
 ns = not sampled



R0079880

**Table 3: Comparative Pollutant Removal at Three Ontario Stormwater Ponds in Wintertime Conditions**  
(removal rates based on average event mean concentration reduction method)

Parameter <sup>1</sup>	Heritage Park Wet Pond	Harding Park Wet ED Pond w/marsh	Rouge River Wet ED Pond
Total Suspended Solids	86%	78%	75%
Total Phosphorus	65	56	67
Ortho-phosphorus	30	66	74
Nitrate-nitrogen	(-1)	(-12)	(-18)
TKN	34	31	31
Ammonium	(-68)	(-18)	14
Cadmium	49	80	63
Copper	65	22	41
Lead	27	11	73
Zinc	72	38	25
Fecal Coliform	83	(-3)	ns
Chloride	(-73)	(-3)	(-17)
Pentachlorophenol	45	ns	20
Oil/Grease	ns	29	51
DOC	ns	(-90)	1

Notes: 1. Winter removal based on 10 or more paired samples at each pond.  
ns = not sampled

**Table 4: Comparative Outflow Concentrations From Three Ontario Stormwater Ponds During Growing Season**

Parameter	Heritage Park Wet Pond	Harding Park Wet ED Pond w/marsh	Rouge River Wet ED Pond
Total Suspended Solids	16	48	37
Total Phosphorus	0.07	0.11	0.06
Ortho-phosphorus	0.03	0.014	0.006
Nitrate-nitrogen	0.65	0.66	0.97
Total Nitrogen	1.60	1.66	1.58
Copper	0.008	0.005	0.010
Zinc	0.010	0.016	0.067
Fecal Coliform	1779	2858	783
Chloride	81	71	580
Oil/Grease	nd	0.8	1.5
DIC	nd	30.7	49.1

Notes: all units in mg/l except for fecal coliform which is in units of colonies per 100 ml. Winter outflow concentrations were generally in the same range as growing season concentrations, with the exception of chlorides, total nitrogen and phosphorus.

growing season. The three ponds were unable to remove chloride during the winter months, and chloride levels in pond outflow were two to three times higher in the winter than during the summer months. Still, the overall winter performance of the three ponds was much higher than that reported for other ponds and pond/wetland systems in cold climates (see article 71).

Winter chloride inputs continued to have a strong influence on the ponds during the summer months. There was evidence of gradual accumulation of chlorides in the bottom of the permanent pool over time, and a strong chemical stratification was observed at two of the ponds during the summer. The stratification was caused by a dense layer of chloride-rich water that entered the pond in the winter and persisted at the bottom of the pond throughout the summer months.

#### *Stream Warming*

Each of three catchments produced about 0.1 cfs of base flow that continuously flowed through the ponds most of the year. Other researchers have demonstrated that wet ponds can dramatically increase base flow water temperatures during the summer. This "delta-T effect" has the potential to harm aquatic species adapted to cold and cool water conditions, but has not been studied extensively in northern latitudes. The SWAMP team reported high delta-Ts during the months of July and August for the Heritage Estates wet pond (nine to 13 degrees F), the Harding Park wet ED pond (nine to 18 degrees F) and the Rouge River wet ED pond (11 to 14 degrees F). One of the ponds (the Rouge River pond) had an outflow pipe situated several feet below the permanent pool, but this design feature did not appear to greatly influence the ponds' delta-T.

Baseflow water temperatures were typically in the low 60s to 70s when they entered the pond in the summer, but warmed to the high 70s to mid 80s by the time they exited the pond. The baseflow water temperatures consistently violated provincial temperature criteria to protect cold water fisheries. However, the study team noted that in each case downstream water temperatures quickly recovered as a result of groundwater inflows, riparian forest cover, and the confluence with larger streams.

#### *Sediment Deposition and Sediment Quality*

The study team measured the average rate of sediment deposition within two of the ponds. The stabilized residential drainage at the Heritage wet pond had a very low deposition rate of about 0.1 inch/year, whereas the Rouge River wet ED pond had a deposition rate of about one inch per year. Sediment deposition rates for these ponds were at the lower range reported in a wider study of deposition for other stormwater ponds in the Toronto region (0.5 to 10 inches per year, GIC, 1999). Extrapolating their data using a pond simu-

lation model, the study team predicted a 30 to 50 year sediment clean out cycle would be sufficient to maintain the sediment removal rates for the three ponds.

Pond sediments were tested to evaluate whether they could meet provincial quality criteria for safe sediment disposal. Sediments from the Heritage Estates wet pond were found to be suitable for land application, whereas the sediments of the main cell of the Rouge River wet ED pond were not (primarily because of high metals from roadway runoff). According to current OME sediment disposal criteria, sediments from this pond will ultimately need to be land-filled. Testing of sediments in the pond's forebay revealed coarse sands that were not contaminated by pollutants.

#### *Plant Community*

The study also included a detailed investigation of how wetland plants colonized the ponds and their buffers after they were constructed. The Harding Park pond was initially planted with 11 wetland species shortly after construction, while the Rouge River pond was started with five species. As might be expected, the initial coverage and density of wetland plants were rather poor, both above and below the permanent pool. However, within two years after construction, more than 75 aquatic and meadow wetland plant species were found within each facility, and plant coverage was quite dense. Most of the originally planted species were still found in the wetland community after three years. About a third of the colonizing species were found to be non-native species, and the plant community was showing signs of invasion by more aggressive species, such as purple loosestrife, cattail and water plantain. Still, the considerable wetland diversity attained in such a short time by natural colonization has led some to question the notion of requiring elaborate pondscaping plans at the time of construction.

#### **Summary**

The performance of the three Canadian ponds compares favorably to the median performance of 36 wet ponds and wet ED ponds that had been monitored in the 1980s and early 1990s (see article 64), particularly with respect to suspended sediment, total phosphorus and trace metals, such as copper and zinc. Indeed, as a group, the Canadian ponds performed comparably to Texas wet and wet ED ponds (article 74). The pollutant removal performance of both groups of ponds ranks among the highest recorded for any stormwater practice, despite the dramatic differences in climate between the two regions. Clearly, their high performance can be partly attributed to their large water quality storage volumes, and possibly to their more progressive design features, as well.

At this point, it is difficult to infer exactly which pond design features promote higher pollutant removal.



**R0079882**

For example, the Harding Park extended detention wet pond/marsh was clearly the most complex pond design in the Canadian study, but it actually performed slightly worse than the two more simply designed ponds. It is worth noting that the Harding Park pond allocated a much greater proportion of its water quality storage volume to temporary extended detention rather than permanent pool, which suggests that permanent pool volume can be a very important factor controlling removal rates. Still, the key lesson from recent stormwater pond monitoring is that reliable pollutant removal can be achieved even in demanding climates, when enough permanent pool volume is provided and innovative design and landscaping features are incorporated into pond designs. As a consequence of the SWAMP monitoring program, the province of Ontario is refining its pond design criteria, and expects to issue a new provincial stormwater manual in 2000. See also article 71.

-TRS

#### References

- Greenland International Consultants. 1999. *Stormwater Management Facility Sediment Maintenance guide. Stormwater Assessment Monitoring Performance Program (SWAMP)*. Toronto and Region Conservation Authority. Toronto, Canada. 69 pp.
- Liang, W. and M. Thompson. 1996. "Performance Assessment of an Off-line Stormwater Management Pond." *Stormwater Assessment Monitoring Performance Program (SWAMP)*. Ontario Ministry of Environment. Toronto and Region Conservation Authority. Toronto, Canada. 234 pp.
- Ontario Ministry of Environment. 1994. *Stormwater Management Practices: Planning and Design Manual*. Marshall Macklin and Monaghan Ltd. Toronto, Ontario. 260 pp.
- SWAMP. 2000a. *Performance Assessment of a Highway Stormwater Quality Retention Pond - Rouge River, Toronto, Ontario*. Stormwater Assessment Monitoring Performance (SWAMP) Program. Ontario Ministry of Environment. Toronto and Region Conservation Authority. Toronto, Canada. 124 pp.
- SWAMP. 2000b. "Performance Assessment of a Stormwater Retrofit Pond - Harding Park, Richmond Hill, Ontario." *Stormwater Assessment Monitoring Performance (SWAMP) Program*. Ontario Ministry of Environment. Town of Richmond Hill. Toronto and Region Conservation Authority. Toronto, Canada. 124 pp.

## A Tale of Two Regional Wet Extended Detention Ponds

**W**hy do some stormwater ponds work, and others don't? How can virtually identical ponds located just a few miles away from each other have dramatically different pollutant removal capability? Some interesting answers to these questions can be gleaned from recent research performed by Robert Borden and his colleagues at North Carolina State University.

The setting for their study is the rapidly growing North Carolina Piedmont. In response to concerns about development's influence on water quality in local water supply reservoirs, many communities employ large regional wet extended detention (ED) ponds to remove pollutants from stormwater runoff generated by new development. State stormwater regulations promote the use of these ponds, on the basis of prior national research that has generally demonstrated they are highly effective in removing many stormwater pollutants of concern (see article 64 for a review). Consequently, regional wet ED ponds were adopted as a central element of a protection strategy for the City Lake reservoir near High Point, North Carolina. Local officials are now implementing a network of 33 regional wet and dry extended detention ponds to remove stormwater pollutants from future development in the 31-square mile watershed that contributes runoff to the drinking water reservoir.

Borden *et al.* (1997) conducted an intensive monitoring study to document the pollutant removal performance of the first two large regional ponds constructed to protect the reservoir. Each pond was a wet extended detention pond that served a watershed nearly two square miles in size, and was built in advance of anticipated watershed development. The first pond was known as Davis Pond and had a rural drainage area of some 1,258 acres, consisting mostly of dairy farms, crops and forest, that will ultimately be converted into low-density residential development. The second pond, called Piedmont, drained a partially developed 1,220-acre subwatershed that included a large petroleum tank farm, industrial development, highways and open land slated for further development.

Intensive sampling at major inflows and outflows to each pond during both baseflow and storm conditions allowed very accurate computation of the mass of pollutants entering and leaving each facility. Over a single year, 22 storms were sampled at Davis Pond and

25 storms sampled at the Piedmont Pond, as well as 12 samples of baseflow conditions. The suite of pollutants measured included sediment, nutrients, carbon, coliform bacteria, and metals. In addition, researchers also intensively sampled water quality conditions occurring within each pond, taking monthly samples of dissolved oxygen, temperature, nutrients, chlorophyll, secchi depth and other parameters at various depths in the pond water column throughout the growing season. Lastly, the research team sought to understand the nutrient and sediment dynamics of the ponds using a series of simple and complex models.

At first glance, the Davis and Piedmont ponds were very similar (Table 1). Both drained about the same drainage area, and were located just a few short miles from each other. Their subwatersheds both had the same fine-grained clay soils for which the region is known. Both ponds had about the same surface area and depth, and had desirable length to width ratios. Both ponds had a similar permanent pool volume, and provided considerable additional extended detention volume. Both ponds stratified during the summer months, and experienced moderate sediment inputs.

At second glance, however, the two ponds could hardly be more different. As noted earlier, Davis pond was rural while Piedmont pond was primarily industrial (and had twice as much impervious cover). Average drawdown time for Davis Pond was nearly 60 hours, while Piedmont had an average drawdown time of less than eight hours. Algal conditions in Davis Pond were hyper-eutrophic, whereas Piedmont Pond barely registered as eutrophic at all. Incoming phosphorus concentrations were typically three times higher in Davis Pond than Piedmont. And whereas no stormwater practices were located upstream of Davis Pond, nearly half of the total drainage area to the Piedmont Pond (48%) was subject to prior treatment from an upstream stormwater pond at an industrial site. Lastly, the year in which Davis Pond was monitored was a dry year (rainfall only 78% of normal), compared to the relatively normal year monitored at Piedmont (93% of normal rainfall).

The pollutant removal performance observed at the two North Carolina ponds was considerably different (Table 2). On one hand, Davis Pond was found to have an overall pollutant removal just slightly below the national median for stormwater ponds. Davis Pond removed an estimated 60% of incoming sediment, 45 to 60% of phos-

**Table 1: Comparative Profile of the Davis and Piedmont Wet Detention Ponds in North Carolina**

Feature	Davis Pond	Piedmont Pond
Drainage Area (acres)	1258	1220
Watershed Imperviousness (%)	16	30
Land Use	Farmland	Industrial
Watershed Soils	70% HSG 'C'	60% HSG 'C'
Pond Surface Area (acres)	12.7	10.0
Mean Pond Depth (feet)	4.9	4.1
Pool Storage Volume (wi) <sup>a</sup>	0.65	0.5
Temp. ED Storage Volume (wi)	0.74	1.17
Average Drawdown Time (hrs)	59 hours	7.7 hours
Length to Width Ratio	3.75 : 1	7 : 1
Pond Area/Drainage Area Ratio	1.01%	0.97%
Upstream Stormwater Practices?	None	Upstream pond on 48% of DA
Year Sampled	1994	1995
Number of Storms Sampled	25	22
Annual Rainfall	78% of normal	93% of normal
Stratifies During Summer?	Yes	Yes
Trophic State <sup>b</sup>	Hypereutrophic	Mesotrophic
Storm inflow TSS conc (mg/L)	145	101
Storm inflow TP conc. (mg/L)	0.36	0.13

<sup>a</sup> wi = watershed inches  
<sup>b</sup> As computed using the North Carolina Trophic State Index

phorus forms, and 70 to 90% of fecal coliforms. Removals of organic carbon, nitrogen and total copper was rather low (approximately 20%), and zinc and lead removal was also fairly modest.

On the other hand, the Piedmont Pond ranked as one of the lower performers on record, particularly given its large design volume. Only 20% of sediment was removed as it passed through Piedmont, and the pond appeared to slightly export bacteria. Removal of dissolved phosphorus was also disappointing (15%). On the positive side, Piedmont was fairly effective in removing soluble nitrate, but showed very modest ability to remove organic carbon or total nitrogen (approximately 30%).

Thus, despite their design similarities, the two ponds have clearly different removal dynamics and capabilities. Borden and his colleagues diagnosed why the two ponds behaved differently by analyzing internal pond water quality data and applying models. Several key

factors appeared to explain their wide divergence in pollutant removal performance.

The first key factor involved algal production. Davis Pond, by virtue of its higher phosphorus loading and long residence time experienced very high algal production. Monitoring revealed high chlorophyll *a* and shallow secchi depth readings throughout the growing season, and the pond was classified as hyper-eutrophic according to the North Carolina Trophic State Index (NCTSI) (Table 3). Modeling showed that incoming nutrients were taken up by the pond algae, incorporated into biomass, and eventually settled to the bottom sediments of the pond. The high algal production, coupled with the pond's shallow depth, created a very strong vertical stratification in the water column during the summer. While nitrogen uptake was also strong in the summer months, ammonia nitrogen produced by decomposition of bottom sediments tended to be trapped and accumulated in the bottom waters of the pond (known as the hypolimnion). Once pond stratification broke down with the onset of cooler weather, much of this ammonia mixed through the water column and was then discharged from the pond, which may account for the mediocre removal of total nitrogen noted at Davis. Also, not all algae produced in the pond settled with the sediments; a substantial portion was discharged from the pond, as evidenced by the export of chlorophyll *a* seen in Table 2.

While Davis pond was an algae factory, Piedmont was not. Incoming phosphorus concentrations were often too low to stimulate algal growth. Secchi depth readings averaged three feet, and the average chlorophyll *a* level was a mere 10 µg/L during the growing season. Inorganic nitrogen and phosphorus levels within the pond were frequently below detection limits during the summer, clearly limiting algal growth. Consequently, Piedmont was classified as only mildly eutrophic using the NCTSI technique. Since algal production was so low within Piedmont pond, nutrient uptake was not a major removal mechanism within the pond.

The second key factor explaining the divergent removal capability was the particle size distribution of incoming sediments. The research team showed that the particle size distribution of sediments generated from both subwatersheds were exceeding hard to settle out (Table 4). Sixty percent of the incoming sediments to both ponds had measured settling velocities of one foot per second or less, which is near the limit for meaningful sediment removal. The higher sediment removal reported for other stormwater ponds is simply due to the fact that they receive more sediment mass in heavier fractions that are much easier to settle out. The fine clay soils eroded from the subwatershed limited the capability of both North Carolina ponds to achieve a higher sediment removal rate. Since Davis Pond had a much longer drawdown time (59 hours compared to





**Table 2: Pollutant Removal of North Carolina Ponds  
Percent Annual Mass Removal (including baseflow and stormflow conditions)**

Monitored Parameter	Davis Pond (%)	Piedmont Pond (%)	National Median <sup>c</sup> (%)
Total Suspended Solids	60	20	67
Total Organic Carbon	22	27	41
Total Phosphorus	46	40	48
Dissolved Phosphorus	58	15	52
Total Nitrogen	16	30	31
Nitrate-Nitrogen	18	66	24
Fecal Coliform	48 <sup>a</sup>	(-5)	65
Copper	15 (-30.3) <sup>b</sup>	nd	57
Lead	51	nd	73
Zinc	39 (60.5) <sup>b</sup>	nd	51
Chlorophyll a	(-193)	neg	nd

<sup>a</sup> Average monthly removal ranged from 70 to 90%, annual mean influenced by a single outlier.

<sup>b</sup> Numbers in parentheses indicate removal of soluble metal fraction.

<sup>c</sup> Brown and Schueler, 1997

**Table 3: The Trophic State of Two Stormwater Ponds**

Constituent	Davis Pond (1994)		Piedmont Pond (1995)	
	Annual Mean	NCTSI Score	Annual Mean	NCTSI Score
Secchi Disc (in.)	22	0.92	36	0.41
Chlorophyll a (µg/L)	61	1.52	9.1	-0.07
Total P (mg/L)	0.151	1.92	0.037	0.32
Total Organic N (mg/L)	1.23	2.03	0.291	-0.33
<b>INDEXTOTAL</b>		<b>6.38</b>		<b>0.32</b>

The North Carolina Trophic State Index (NCTSI) provides a quantitative index of eutrophication, based on the total score derived from four lake-wide annual mean variables: concentrations of total organic nitrogen and total phosphorous (mg/L), chlorophyll-a (micrograms/ L) and average secchi disk depth (in inches). A index score of less than -2 indicates oligotrophic conditions, -2 to 0 indicates mesotrophic conditions, 0 to 5 eutrophic conditions, and a score more than 5 indicates hypereutrophic conditions.

eight at Piedmont), however, it had a longer time frame to settle fine-grained sediments.

The last key factor relates to upstream treatment. As noted earlier, nearly half of the Piedmont subwatershed was also served by an upstream pond. Although no actual monitoring data was available to assess the effectiveness of the upstream pond, it appeared to have a strong influence in reducing inflow concentrations to the downstream pond. Borden noted that inflow concentrations were routinely two to four times lower at

Piedmont than Davis. In addition, it was speculated that coarse sediment particles were preferentially removed in the upstream pond, making it that much more difficult to settle sediments in the downstream pond.

Researchers tested a series of simple and complex models to explain the sediment and nutrient removal dynamics of the Davis and Piedmont Ponds. Three models were found to be poor predictors of sediment removal at the test ponds: Brune's empirical curve, Heinemann's curve and Driscolls stochastic sediment-

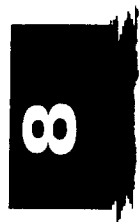

R0079886

**Table 4: Settling Velocity Fractions for Stormwater Sediments in Feet per Hour**

Sediment Size Fraction	% of Sediment by Mass	National	North Carolina Region	Study Area
1	0 to 20%	0.03	0.01	0.04
2	20 to 40	0.30	0.08	0.44
3	40 to 60	1.50	0.40	0.93
4	60 to 80	7.00	1.80	1.9
5	80 to 90	65.00	6.00	4.44

tation model. A complex continuous lake simulation model adapted from the Minnesota Lake Water Quality Model (MINLAKE — Riley and Stefan, 1988) aptly predicted seasonal trends in pond dynamics and produced relatively accurate predictions of sediment and nutrient removal. Interesting, a very simple empirical equation developed by Reckhow (1988) to predict nutrient behavior in Southeastern lakes also proved to be reasonably accurate in predicting annual nutrient removal rates for large stormwater ponds. The Reckhow equations predict phosphorus and nitrogen trapping efficiency for phosphorus and nitrogen in lakes based on simple parameters

$$K_p = 3.0 P_m^{0.53} T_w^{-0.75} z^{0.58}$$

$$K_n = 0.67 T_w^{-0.75}$$

$K_p$  = trapping efficiency for phosphorus

$K_n$  = trapping efficiency for nitrogen

$P_m$  = mean annual influent TP concentration (mg/l)

$T_w$  = hydraulic residence time (years)

$z$  = mean depth (meters)

The predictive value of the simple Reckhow model is shown in Table 5. A quick review of the first equation shows the importance of inflow phosphorus concentration and increased residence time in pond or lake removal efficiency.

—JSB/TRS

**References**

Borden, R.C., J. L. Dorn, J. B. Stillman, and S.K. Liehr. 1997. *Evaluation of Ponds and Wetlands for Protection of Public Water Supplies*. Water Resources Research Institute. University of North Carolina. Raleigh, NC. pp. 88.

Brown, W. and T. Schueler. 1997. *Pollutant Removal Database of Current Urban Stormwater BMPs*. Center for Watershed Protection. Silver Spring, MD. pp. 116.

Reckhow, K.H. 1988. "Empirical Models for Trophic State in Southeastern US Lakes and Reservoirs." *Water Resources Bulletin* 24: 723-734.

Riley, M., and H. Stefan. 1988. "MINLAKE: A Dynamic Lake Water Quality Simulation Model." *Ecological Modeling* 43: 155-182.

**Table 5: Comparison of Observed and Predicted Nutrient Removal for North Carolina Stormwater Ponds Using the Reckhow Equations**

Annual Nutrient Removal (%)	Davis Pond		Piedmont Pond	
	Total P (%)	Total N (%)	Total P (%)	Total N (%)
Observed	46	16	40	36
Predicted	51	24	30	21



# Performance of a Dry Extended Pond in North Carolina

A dry extended detention (ED) pond relies on settling as the primary mechanism to remove pollutants from stormwater runoff. A dry ED pond is normally empty during dry weather, but rapidly fills up with runoff during a storm event. The stored runoff is gradually released over a period of one to three days, allowing an opportunity for pollutants to settle out to the floor of the pond. Settling can be a very important pollutant removal mechanism, but it does have its limits. Earlier performance monitoring indicated that dry ED ponds had low to moderate ability to remove most stormwater pollutants (see article 64). This conclusion, however, is considered provisional, as many of the dry ED ponds that were monitored failed to achieve their target extended detention times due to design problems. A recent study by Stanley (1994) sheds new light on the potential performance of well-designed dry ED ponds.

Stanley and his colleagues monitored a demonstration dry ED pond in a small coastal plain watershed in North Carolina, and also conducted experiments to explore the settling behavior of stormwater pollutants. The dry ED pond served a 200 acre watershed, composed of a mix of single family, multifamily and commercial land uses (total imperviousness= 29%). Located near Greenville, NC, the watershed had the sandy soils and low relief characteristic of the coastal plain.

The dry ED pond was designed to provide a maximum of 72 hours of detention for the first half-inch of runoff through the use of a vertical perforated pipe at the pond's outlet. Any runoff in excess of the half-inch was bypassed through a concrete spillway, and was not treated. The pond ranged in depth from eight to 11 feet deep when full, but was designed to fully drain after a storm event. Like many other "dry" ED ponds, the 1.75 acre grass bottom of the pond has gradually become soggy since it was constructed in 1991, and some portions near the outlet reverted to a shallow wetland.

The pond's performance was monitored during eight storm events in 1992, that ranged from about a half-inch to two inches of rainfall. One storm, however, was a real whopper. This storm dropped a total of 9.28 inches of rain over a period of less than five days. As a consequence, about 70% of the total runoff volume bypassed the pond through the spillway during this rare storm and was not treated. Thus, Stanley's sampling

effort provides a glimpse of how well ED ponds perform during extremely large and rare storm events.

The overall results of the performance monitoring were generally consistent with prior studies (Table 1). Removal of particulate pollutant that are prone to settling was moderate to high, and removal of predominantly soluble pollutants (not subject to gravity) was low or negligible. This behavior was particularly evident when nitrogen and phosphorus was considered. Removal of the particulate fraction of nutrients was moderate (33 to 43%) while removal of soluble nutrient fractions was poor (+ 10% to -9%). Consequently, the combined removal rate for total phosphorus and nitrogen was a modest 14% and 24%, respectively. Removal rates for trace metals predominantly found in particulate forms ranged from 40 to 50% (cadmium,

**Table 1: Median Pollutant Removal Rate Observed in the Greenville Dry ED Pond (N=8)**

Water Quality Parameter	All Storm (%)	Big Storm*
Total Suspended Solids	71	25
Particulate Organic Carbon	45	19
Particulate Nitrogen	43	22
Particulate Phosphorus	33	17
Cadmium	54	12
Chromium	49	16
Copper	26	11
Lead	55	19
Nickel	43	27
Zinc	26	11
Ammonia (NH <sub>3</sub> -N)	9	20
Nitrate-N	(-2)	6
Total Dissolved Phosphorus	(-9)	6
Dissolved Organic Carbon	(-6)	(-5)
Total Phosphorus	14	—
Total Nitrogen	26	—

\* Removal Rate includes pollutants that bypassed the pond through the emergency spillway and were not subject to settling



**R0079888**

**Table 2: Pollutants Settled After 72 Hours, Average of Three Trials (Stanley, 1994)**

Water Quality Parameter	Percent Settled
Total Suspended Solids	93
Lead	77
Cadmium	73
Chromium	72
Nickel	66
Total Nitrogen	50
Total Phosphorus	46
Copper	45
Zinc	35
Total Organic Carbon	35
Dissolved Organic Carbon	23

chromium, nickel and lead) whereas removal rates for metals that are partially in soluble form (such as copper and zinc) were only half as great. Limited sampling fecal coliform indicated that bacteria levels were slightly reduced as they passed through the dry ED pond.

Table 1 also shows the pollutant removal that occurred in the pond during the rare 9.28 inch rainfall event. Stanley calculated the removal rate based on the total inflow and outflow from the pond, which includes about two thirds of the total runoff volume that bypassed the pond and was not subject to settling. As might be expected, removal rates sharply declined during the storm. Still, removal rates remained positive, which is surprising given that only one-third of the runoff volume was ever subject to extended detention. This suggests that the ED pond was still capable of providing good removal for the first half inch of runoff, even during a storm that delivered six times more runoff volume (three inches) than was designed to be treated.

The results of three settling column experiments were generally consistent with prior research on pollutant settling in urban runoff, as well as the performance monitoring results (Table 2). Moderate to high removal was observed for particulate pollutants after 72 hours, such as suspended sediment, particulate forms of carbon and nutrients, and several trace metals. In most cases, the bulk of the settling occurred in the first 6 to 12 hours of the settling experiments.

Only minor increments of additional settling occurred in the second or third day. Pollutants that are present partly or mostly in soluble forms, such as orthophosphorus, copper and zinc, did not settle out, even after 72 hours of settling. A comparison of the settling column data with actual pond performance data reveals that removal rates were consistently 20 to 30% higher under the ideal settling conditions of the column experiments. This would seem to suggest that more turbulent conditions in the pond reduced settling rates.

Stanley's study provides further evidence as to the benefits and limitations of dry extended detention. Clearly, such ponds are capable of effectively removing particulate pollutants, but have little or no capability to remove soluble pollutants that often have the most influence on downstream aquatic ecosystems. Pond systems that utilize other pollutant removal mechanisms, such as wet ponds and stormwater wetlands, still offer more reliable removal for these pollutants.

—TRS

**Reference**

Stanley, D. 1994. *An Evaluation of the Pollutant Removal of a Demonstration Urban Stormwater Detention Pond*. Albermarle-Pamlico Estuarine Study. Report 94-07. 112 pp.

# Influence of Groundwater on Performance of Stormwater Ponds in Florida

Stormwater quality treatment and flood control can be difficult in Central Florida. Flat topography and a high water table make it very difficult to separate stormwater from groundwater. A common stormwater management approach in this low-relief environment has been to construct regional ponds or wetlands. These are typically excavated below the water table to provide the required pool storage for pollutant removal. Weirs above the pool are used to create additional storage needed to protect residents from flooding caused by the intense rainfall for which the region is noted. Many regional ponds serve very large drainage areas—from one to two square miles in size. Consequently, the regional ponds are located “on-line” and are fed by base and storm flow from canals and ditches.

Several concerns have been raised about the performance of regional ponds and wetlands in such environments. First, will a regional pond’s performance decline because the permanent pool is supplied by groundwater rather than stormwater? And, second, since groundwater is a more significant component of a regional pond’s water budget, will the ponds prove effective in removing pollutants during dry weather conditions? Some intriguing answers to these questions have emerged from three recent monitoring studies in Central Florida.

In the first study, Kevin McCann and Lee Olson investigated the pollutant removal performance of a retrofit pond located in Orlando, Florida. The retrofit, known as Greenwood, was truly a “deluxe” model of a pond system. Greenwood consisted of a sediment basin that pre-treated runoff before entering a three-cell pond system with broad wetland benches. More than 13 acres in area, the pond had many innovative design features such as water reuse (for landscaping irrigation), four fountains to aerate deeper pools, and skimmers near the outlet (see Figure 1). The entire system was extensively landscaped, including a riverine floodplain and broadleaf marsh, creating a park area with a trail network for passive recreation. The pond had a drainage area of some 572 acres where land use was more than 50% residential, and a water quality treatment volume of 1.25 watershed inches. Like many Florida ponds, it was formed by excavating well below the normal water table (Table 1).

**Figure 1: Schematic of the Greenwood Pond System (McCann and Olson, 1994)**

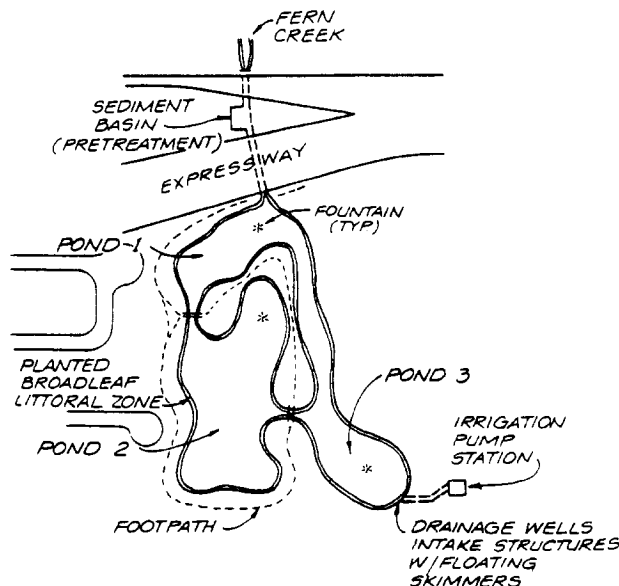

The Greenwood pond had a unique water budget. The pond actually discharged into the Floridian aquifer through drain wells. The drain wells and low topographic position of the pond created a positive gradient for groundwater movement, thereby “attracting” groundwater inflows from an area five times greater than its “surface runoff” watershed. As a result, groundwater inflows dominated the water budget of the pond, with 46.7% of the total outflow from the pond estimated to be groundwater seepage. Of the remaining outflow, about 75% was from stormflow and 25% from surface baseflow.

McCann and Olson sampled flow and pollutant concentration at three stations above and below the pond during 11 storm events and eight baseflow periods. Pollutant removal was computed based on the reduction of mass loads during both storms and dry weather for the entire pond system. For the sediment basin, removals were based on the mean of storm EMC reductions. Results are shown for the sediment basin and the entire pond system in Table 2.



R0079890

**Table 1: A Comparison of Design Features:  
St. Joe's Creek and Greenwood Stormwater Quality Facilities**

Criteria	St Joe's Creek	Greenwood
<b>Drainage Area</b>	1,280 acres	527 acres
<b>Surface Area</b>	25 acres	13 acres
<b>Treatment Volume</b>	0.25 watershed inches (estimated)	1.25 watershed inches (estimated)
<b>Detention Storage?</b>	YES, unspecified	YES, 243 acre-feet
<b>Cells</b>	One cell, but fill area may have created a two-cell system	Three cell design
<b>Average Pool Depth</b>	1.15 feet average, maximum of 5 feet	5.1 feet
<b>Design Features</b>	Primarily a flood detention pond with a "shallow pool" 24 hour detention	Broad wetland benches, water reuse, aeration fountains, sediment pretreatment basin, and extensive pondscaping
<b>Monitoring Effort</b>	6 storms, 16 baseflow samples	11 storms, 8 baseflow samples
<b>Removal Calculation</b>	Median storm load reduction	Load reduction
<b>Baseflow as % of Total Flow</b>	30% (estimated)	24.6%
<b>Groundwater Influence?</b>	Yes, 38.5% of outflow was due to groundwater inflow	Yes, 46.7% of outflow was due to groundwater inflow
<b>Excavated to Groundwater?</b>	YES	YES
<b>Baseflow Residence Time</b>	8 days	23 days
<b>Location</b>	On-line, below stream elevation	On-line, below stream elevation

In general, the sediment basin was only marginally effective as a pretreatment device, probably due to its relatively small size. About 14% of incoming sediment was retained in the trap during storm events. The sediment basin also exhibited mediocre performance in removing nutrients and metals, with removal of most of these parameters falling within a range + or - 15%. During dry weather periods, no major change in pollutant concentration was reported as they passed through the sediment basin.

The pond system, on the other hand, showed excellent removal capability for many parameters. Sediment, for example, was removed at a 68% rate, which is nearly identical to the national median removal rate for wet ponds. Total and soluble phosphorus forms were removed at the impressive rates of 62% and 77%, respectively. Removals of copper, lead and zinc all fell within a 60 to 70% range. Surprisingly, the Greenwood pond was not effective in removing any form of nitrogen, with a net outflow of about 10% for total nitrogen over the study period. Poor nitrogen removal was attributed to high nitrogen concentrations in groundwater inflow to the pond that exerted a strong influence on the nitrogen budget of the facility. As noted earlier,

nearly half of the pond's water budget was due to groundwater inflow, rather than stormflow or surface baseflow. Water quality sampling within the pond revealed a system that was only mildly eutrophic, as indicated by both low chlorophyll a levels (7.3 ug/l) and deep secchi-depth readings (5.1 feet).

The reported removal rates for Greenwood, however, may underestimate the potential pollutant reduction that can be achieved by such a facility. This is evident when the outflow concentrations from the pond are more closely examined (see Table 3). Sediment and nutrient concentrations in the outflow of Greenwood Pond were about 50% lower than the national mean from other ponds and wetlands. This may suggest that Greenwood's removal capability may have been limited by the relatively low concentrations of stormwater pollutants entering the facility.

Whereas the Greenwood pond might be termed a deluxe pond, the St. Joe's pond investigated by Kantrowitz and Woodham (1995) was clearly an economy model. Located on the West Coast of central Florida, a shallow pool was formed during the construction of a large detention pond designed for flood control (see Figure 2). The pond served a 1,280 acre

watershed, was nearly 25 acres in surface area and was fed by a channelized creek (median dry weather flow 1.7 cfs). The pond was excavated four to eight feet below the creek's bed, and had a dry weather residence time of about eight days. The average depth was only 1.15 feet, and much of the pond's surface area has gradually been colonized by aquatic plants. Despite its large surface area, the St. Joe's pond had a modest water quality treatment volume (an estimated 0.26 watershed-inches). A ridge of fill material, left over during construction, divided the pond into two cells during baseflow periods.

Performance monitoring of St. Joe's pond began shortly after it was constructed in 1989. Kantrowitz and Woodham sampled six storm events, computing removal efficiency on the basis of median storm load removal. In addition, 16 pre- and post- construction baseflow samples were collected to examine the pond's influence in modifying water quality in St. Joe's creek. Removal rates were calculated separately, and are shown in Table 4.

St. Joe's pond was moderately effective at removing nutrients during storms, with phosphorus removal ranging from 40 to 50%, and removal of nitrogen forms ranging from two to 40%. While sediment removal was very low during storms (7%), this reflects the fact that median inflow concentrations were a mere 16 mg/l and probably could not be reduced much further. St. Joe's pond was moderately effective in removing biological oxygen demand (49%), and many trace metals (chromium>zinc>copper>lead). Consistent with other studies, the pond exported both dissolved solids and chlorides during storm events. Kantrowitz and Woodham reasoned that much of the removal could be attributed to dilution (i.e., higher storm runoff concentrations mix with lower baseflow concentrations stored within the pond). Although the investigators did not measure the quality of groundwater inflows, it is likely that they contributed to the dilution effect.

**Table 2: Pollutant Removal Capability of the Greenwood Pond System**

Stormwater Pollutant	Removal Rate %	
	Sediment Basin <sup>a</sup>	3 Cell Pond <sup>b</sup>
Total Suspended Solids	12.8	68.3
Total Dissolved Solids	(-6.8)	(-147.8)
Total Phosphorus	(-11.4)	61.5
Ortho-phosphorus	(-7.4)	76.7
Total Nitrogen	3.7	(-11)
Total Kjeldahl Nitrogen	0.3	(-10.3)
Nitrate-Nitrogen	16.0	(-13.2)
Ammonia-Nitrogen	(-100)	(-10.2)
Cadmium	26	n.d.
Lead	9.6	59.7
Zinc	(-5.9)	68.9
Copper	18.6	58.9

<sup>a</sup> Removal based on the mean of storm EMC reductions.

<sup>b</sup> Removal based on the reduction of mass load during both storms and dry weather for the entire pond system.

St. Joe's pond performed even better during dry weather conditions (Table 4) with five to 15% higher removal rates recorded for sediment, oxygen demand, nutrients and several metals. These findings suggest that settling, uptake and adsorption were acting to remove pollutants in the four to eight days that it took for baseflow to travel through the pond. Wetland vegetation was also thought to play a key role in promoting pollutant removal in St. Joe's Pond during baseflow conditions, as removal efficiency improved when wetland plant cover increased.

The fact that groundwater-influenced ponds can reduce concentration of pollutants in stormwater and baseflow does not necessarily imply that they will

**Table 3: Comparison of Outflow Concentrations for Greenwood Pond System with National Mean of Stormwater Wetland Outflow Concentrations (all units in mg/l)**

Pollutant Type	Greenwood Baseflow Outflow Concentration	Greenwood Stormflow Outflow Concentration	National Mean Stormflow Outflow Concentration *
Total Suspended Solids	6.7	5.9	32
Total Phosphorus	0.09	0.10	0.19
Ortho-phosphorus	0.029	0.03	0.08
Total Nitrogen	0.95	0.98	1.63
Total Kjeldahl Nitrogen	0.78	0.79	1.29
Nitrate	0.17	0.18	0.35

\* Source: article 64; all units in mg/l

always reduce the mass export of pollutants, particularly when they attract large groundwater inflow. For example, monitoring of a groundwater-influenced wet pond in Central Florida revealed a sharp differences in removal efficiency, depending on whether pollutant load or concentration reduction were used as the measure of the pond's removal capability (Wanielista *et al.*, 1988). Specifically, the research done on Angel Pond confirmed that pollutant load reduction was negative over the study period, despite the fact that the pond recorded positive reductions in sediment, metal and

coliform concentrations during stormwater runoff and dry weather flow events. The negative load removal was attributed to the migration of pollutants from groundwater to the pond, which comprised over 75% of the pond's water budget (Wanielista *et al.*, 1988).

The three regional pond studies offer several lessons to the design engineer. First, designers should strive to keep the normal pool elevation above the water table elevation. This can act to reduce the influence of groundwater on the pond's water budget. As a practical target, groundwater should probably supply no more than a quarter of stormwater quality pond's total water budget. Second, designers should not rely on groundwater dilution alone for stormwater treatment. Indeed, depending on local groundwater quality, it is possible for groundwater to magnify rather than dilute some pollutants (particularly nitrogen). Therefore, designers should maximize internal features that can provide greater physical and biological treatment of stormwater. As was discovered in Greenwood pond, longer flow paths, greater residence times, higher treatment volumes and wetland plantings are essential in physical treatment for stormwater in high groundwater areas.

—TRS

Figure 2: Schematic of the St. Joe's Pond and Flood Control Facility (Kantrowitz and Woodham, 1995)

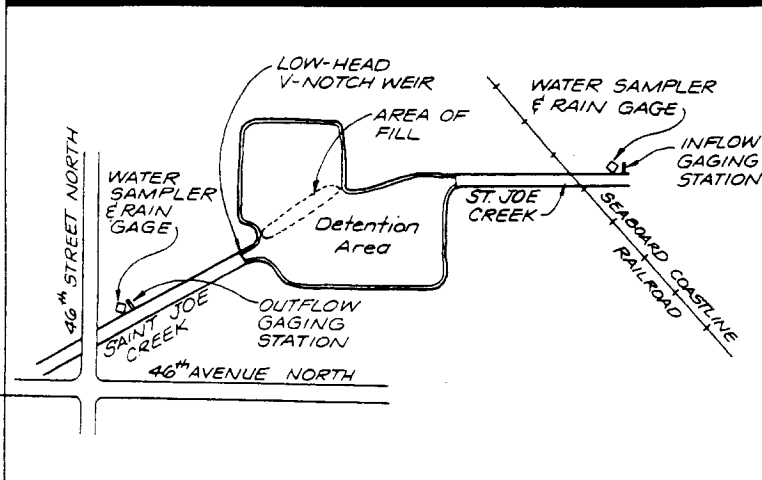

Table 4: Pollutant Removal Rates for St. Joe's Pond (Kantrowitz and Woodham, 1995)

Pollutant	Stormflow (%)	Baseflow (%)
Total Suspended Solids	7	45
Total Dissolved Solids	(-28)	17
BOD	49	65
Total Phosphorus	40	45
Ortho-phosphorus	52	51
Nitrate + Nitrite	23	36
Ammonia	40	83
Total Chromium	255	0
Total Copper	52	38
Total Lead	60	82
Total Zinc	48	50
Chloride	-28	27

Pollutant removal rates for storm events were adjusted to account for intervening drainage area and were based on median storm load removal. Baseflow removal computed by comparing pre-construction and post-construction baseflow loads.

## References

- Kantrowitz, I., and W. Woodham. 1995. "Efficiency of a Stormwater Detention Pond in Reducing Loads of Chemical and Physical Constituents in Urban Streamflow, Pinellas County, Florida." U.S. Geological Survey. *Water Resources Investigations Report: 94-4217*. Tallahassee, FL. 18 pp.
- McCann K., and L. Olson. 1994. "Pollutant Removal Efficiencies of the Greenwood Urban Wetland Treatment System." *Lake and Reservoir Management* 9(2):97-106.
- McCann, K., and L. Olson. 1995. *Final Report on Greenwood Urban Wetland Treatment Effectiveness*. City of Orlando Stormwater Utility Bureau. Prepared for Florida Dept. of Environmental Protection. Orlando, FL. 40 pp.
- Wanielista, M., Y. Yousef and C. Bass. 1988. *Alternatives for the Treatment of Groundwater Contaminants: A Detention Pond with Groundwater Inflow*. University of Central Florida. Florida DOT. FL-ER-88-40. 98 pp.



# The Environmental Impact of Stormwater Ponds

Stormwater ponds are one of the most effective techniques for providing channel protection and pollutant removal for urban streams. However, persistent concerns have been raised about the possible secondary environmental impacts produced by ponds. This article reviews available data on the negative impacts of stormwater ponds on downstream water temperature regimes, downstream dry weather water quality, downstream bedload movement, downstream trophic shifts, upstream fish passage, upstream channel degradation, and destruction of riparian cover and wetlands. The article concludes by suggesting design and "fingerprinting" techniques that can be used to avoid or mitigate these environmental impacts.

Stormwater ponds are among the most adaptable, effective and widely applied stormwater treatment practices in developing areas. The popularity of stormwater ponds can be attributed to their proven ability to attenuate flows from design storms; economies of scale compared to other types of stormwater practices (Wiegand *et al.*, 1986); high urban pollutant removal capability (Schueler and Helfrich, 1988); longevity, particularly in comparison to other types of stormwater practices (MDE, 1991); community acceptance (Adams *et al.*, 1983); and effect on adjacent land prices (Schueler, 1987).

In recent years, many communities have adopted regional stormwater pond policies to achieve maximum stormwater benefits at the watershed scale at minimum cost. Individual ponds serve areas ranging in size from 50 to 500 acres, and are located within the larger watershed using hydrology simulation models.

However, large stormwater pond systems have recently come under increased scrutiny from state and federal environmental regulatory agencies. In many cases, pond designers must obtain both a Section 401 (water quality certification) and/or Section 404 (wetland) permit prior to construction. In an increasing number of cases, permits for pond construction are denied or are issued with rigorous conditions. The most common impacts cited are wetland disturbance, downstream warming, and the sacrifice of upstream stream reaches. Other frequently cited negative impacts of ponds include the creation of barriers to fish passage, poor quality of pond effluent, downstream shifts in stream trophic status, and loss of forests in the floodplain.

To date, very limited research has been conducted on the environmental impacts of stormwater ponds. Typically, the severity of impacts attributed to ponds has been inferred from limnological research studies on the effects of larger impoundments and reservoirs on large river systems (for an excellent review, see Ward and Stanford, 1979 and Petts, 1984). In these systems, impoundments are a "serial discontinuity" and have a pervasive and persistent impact on aquatic life downstream. How well does this paradigm apply to the case of urban stormwater ponds? For a number of reasons, it may not apply totally.

First, stormwater ponds are typically located in headwater streams, as opposed to larger rivers. Second, stormwater ponds tend to be extremely shallow (five to 10 feet), and thus experience only weak stratification. Impoundments, on the other hand, may be from 15 to 150 feet deep, and exhibit very strong seasonal stratification. Third, and most importantly, urban streams differ in many important ways from natural stream ecosystems. Urbanization profoundly changes the hydrology, morphology, water quality and ecology of streams, and the severity of these changes is directly related to the degree of watershed imperviousness (see article 1).

## Environmental Impacts Associated With Stormwater Ponds

This article presents some new research data on the severity of secondary impacts of stormwater ponds. In addition, several design techniques are suggested to minimize secondary impacts.

The range of potential environmental impacts that ponds can exert is shown in schematic fashion in Figure 1. Ponds can have both positive and negative impacts on the local and downstream environment, as discussed below.

### *Alteration on Downstream Temperature Regime*

It has been recognized for many years that urban streams tend to be warmer than undisturbed streams (Pluhowski, 1970). A recent study of headwater streams in the Maryland Piedmont confirmed the existence of a "heat island effect" in urban streams (Galli, 1990). The increase in urban summer stream temperatures from an undeveloped reference stream baseline (denoted as the watershed Delta-T) is a direct function of watershed im-

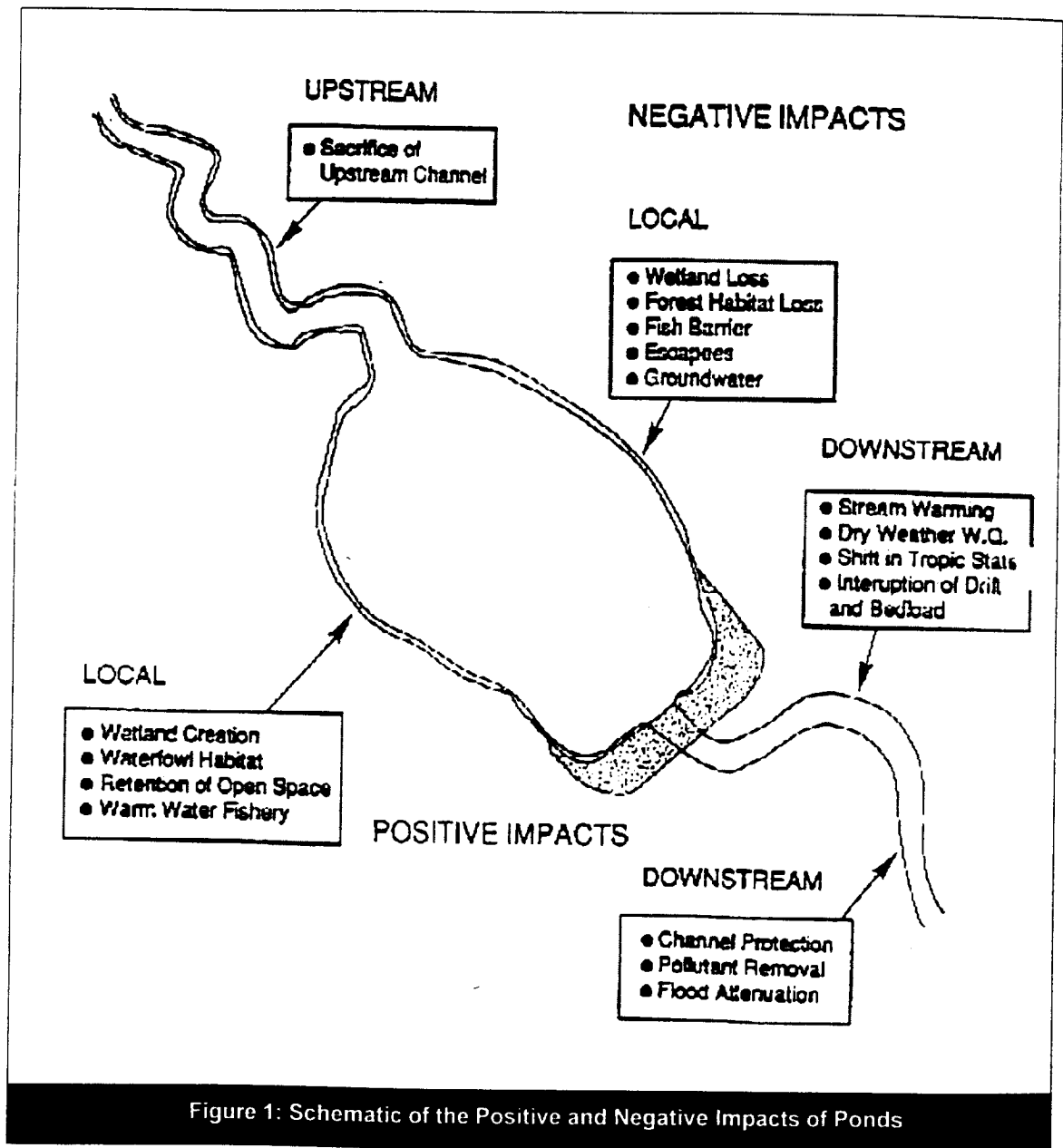

perviousness (Table 1). The summer mean Delta-T for a highly developed headwater stream was 8.6 degrees Fahrenheit, with no statistical difference between baseflow and stormflow conditions. A maximum instantaneous Delta-T of 16.2 degrees F was observed during the hottest portion of the summer.

Stormwater ponds can amplify the warming effect noted for urban streams. The permanent pool of ponds acts as a heat sink during the summer months, and discharges warmer waters during both storm and baseflow conditions (Schueler and Helfrich, 1988). The magnitude of this effect can be characterized by the pond delta-T, which expresses the change in water temperature upstream and downstream of a pond. The mean summer

delta-T for the Countryside wet pond in Maryland was 9.5 degrees F with an instantaneous maximum of 15.1 degrees F (Table 2 and Figure 2). A similar Delta-T was reported by Galli (1988) for the Rolling Acres wet pond. The magnitude of a wet pond Delta-T appears to be a direct function of the size of the permanent pool in relation to the contributing watershed area. For example, a shallow pond system that had a much smaller permanent pool had a correspondingly smaller mean summer Delta-T (Table 2).

No pond system was found to be thermally neutral, even for ponds that did not have a permanent pool. For example, the Tanglewood extended detention dry pond had a mean and maximum Delta-T of 5.1

**Table 1: Effect of Watershed Imperviousness on Stream Temperatures  
Delta-T Values for Six Headwater Streams in the Maryland Piedmont  
Summer, 1989 (Galli, 1990)**

<b>Stream Name</b>	<b>Area (acres)</b>	<b>Flow (a) (cfs)</b>	<b>Impervious (percent)</b>	<b>Mean (b) Delta-T</b>	<b>Max (b) Delta-T</b>
Lakemont	400	0.9	> 1.0	0°F	0°F
Countryside	165	0.25	12	1.9	9.4
Oak Springs(c)	140	0.11	18	2.4	8.4
Fairland Ridge	25	0.05	25	3.7	12
Tanglewood	195	0.26	30	5.1	15.1
Whiteoak Trib	225	0.35	60	8.6	16.2

(a) Measured dry weather baseflow

(b) Delta-T computed as the change in summer mean water temperatures from an undisturbed natural reference stream to a geographically similar urban stream over an identical time interval

(c) The temperature regime of the Oak Springs site was influenced by the presence of a farm pond 100 feet upstream of sampling site.

**Table 2: Effect of Stormwater Pond Systems on Downstream Water Temperatures  
Delta-T Values for Four Maryland Pond Systems  
Summer, 1989 (Galli, 1990)**

<b>Pond Name</b>	<b>Pond System</b>	<b>Mean Delta-T</b>	<b>Max Delta-T</b>	<b>Max Temp of Pond Effluent</b>
Fairland	Dry "Infilter" (a)	2.5°F	7.6°F	77.7°F
OakSprings	ED Shallow Marsh (b)	3.2	8.7	77.7
Tanglewood	Dry ED Pond (c)	5.3	10.9	81.9
Countryside	Wet Pond (d)	9.5	15.1	82.6

(a) Infiltration trenches provide 0.25 inches/imp of WQ storage

(b) 3 acre Dry 24 hr ED Detention w/ 500 foot rip-rap pilot channel

(c) 1 acre shallow wetland (mean depth 18 inches with 24 hr ED)

(d) 1.5 acre pond (mean depth 6 feet) with pond release 2.5 feet below normal pool elevation.



R0079896

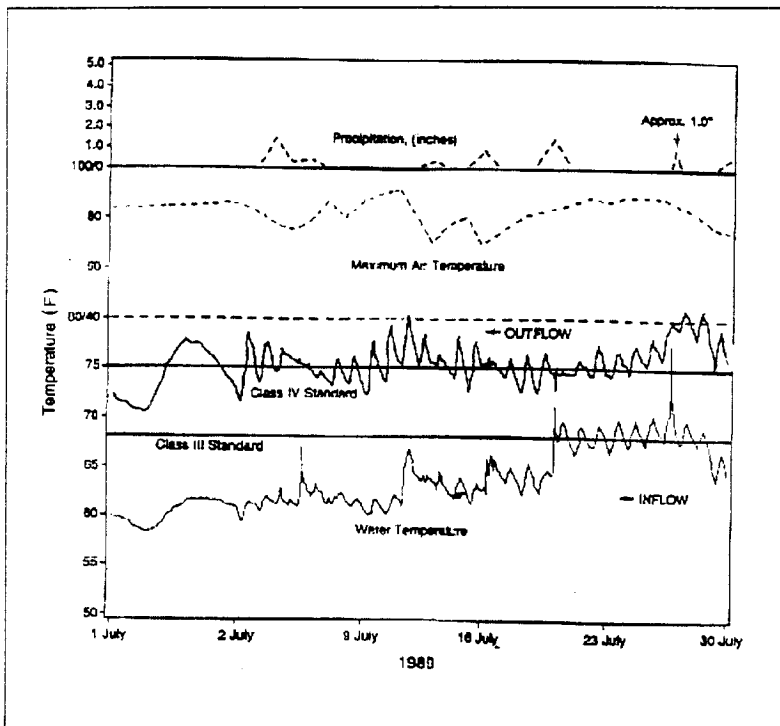

Figure 2: Upstream and Downstream Summer Temp Profiles of a Wet Pond (Galli, 1990)

and 15.1, respectively. The high Delta-T was attributed to warming within the unshaded, rip-rap pilot channel. The lack of riparian cover and the thermal properties of rip-rap and concrete pilot channels can impart significant heat to baseflow and runoff in dry detention ponds. Galli (1991) observed average Delta-T's ranging from one to three degrees F per 100 feet for rip-rap pilot and outfall channels.

The impact of stream warming is especially significant for cool- or cold-water streams. Stream temperature is one of the central organizing features of aquatic communities, and affects the rates of detrital processing, respiration, and bacterial growth, as well as the timing of reproduction, molting and drift for aquatic organisms. For some species, stream warming can be lethal. Salmonoid species, such as trout, are exceptionally sensitive to stream warming (Galli and Dubose, 1991). Stream warming also fundamentally alters macroinvertebrate species composition (particularly so for stoneflies and caddisflies), as well as diatom, periphyton and fungal associations of streams.

#### Poor Water Quality of Pond Effluent

Although most ponds reduce urban pollutant concentrations during storms over the long term, their discharge during dry weather periods can be a concern. Ponds are typically weakly stratified but are

hyper-eutrophic systems that can become partially or totally anoxic in the summer months (Galli, 1988).

Dissolved oxygen (DO) levels discharged from surface and mid-depth release ponds can be hypoxic but are seldom anoxic. About 1% of dissolved oxygen measurements in pond discharges in the Maryland suburbs were below 5.0 mg/l, with a minimum reading of 3.4 mg/l (Galli, 1991). Recovery is usually quite rapid and occurs within a few hundred feet below the pond.

Dissolved oxygen, however, can be a serious problem in ponds that release water from the bottom of the pool. Galli (1988) reported a minimum DO level of 1.7 mg/l at the Rolling Acres wet pond. Deep release ponds also often discharge extremely carbon-rich effluent that can coat the stream substrate and increase the benthic oxygen demand during low flows.

#### Barrier to Downstream Movement of Bedload

Ponds are excellent traps for silt, sand, coarser-grained gravels and cobbles that comprise the bedload of a stream. Because of the limits of gravity settling, ponds are much less effective at trapping fine silts and clays (Schueler and Lugbill, 1990). Thus, ponds tend to totally block the downstream movement of extremely coarse-grained particles, while at the same time exporting a steady supply of fine-grained particles downstream. Galli (1988) provides some evidence that ponds can cause embedding of downstream substrates, with a consequent reduction in habitat value.

#### Downstream Shift in Stream Trophic Status

Ward and Stanford (1979) contend that impoundments create a strong shift in the trophic status of the downstream community. This is often manifested in reduced detrital processing of leaf litter (i.e. the shredding of leaf litter into bacterially rich fine particles) and increased scraping of microbial slime on rocks and filtering of fine organic particles from the water column. This paradigm has been confirmed for wet ponds (see Table 3). A much greater proportion of shredders was found above the pond, whereas a greater proportion of collectors and scrapers was found below it. This presumably reflects differences in the size of carbon fractions utilized by aquatic insects as they are modified by the pond.

Table 4 provides additional conclusions as to the changes in aquatic insect communities above and below the Rolling Acres wet pond, as abstracted from Galli (1988).

#### Sacrifice of Upstream Channels

A frequent concern of large ponds is that they provide no effective control for their tributary drainage, and thereby sacrifice the entire network of up-



**Table 3: Macroinvertebrate Community Trophic Structure Upstream, Downstream and Within a Wet Stormwater Pond, Maryland, April to December, 1985 (Galli, 1988)**

Primary Functional Trophic Category	Riffle Upstream Of Pond	Riffle Downstream Of Pond	Littoral Area Within Pond (a)
	% of benthic community		
Shredders	55.8	1.1	0.5
Collector-Gatherers	6.5	15.7	13.6
Collector-Filterers	12.0	26.0	0.0
Scrapers	13.4	43.4	0.6
Predators	12.3	13.8	85.3

(a) benthic samples only  
 (b) percentage based on lumped individuals within each category for eight sampling surveys.

**Table 4: Other Changes In the Benthic Community Upstream and Downstream of the Rolling Acres Wet Pond Reported by Galli (1988)**

- Riffle substrates below the pond were finer grained, more heavily embedded and contained higher mass of CPOM and FPOM than upstream substrates.
- Greater mass of detrital carbon was evident below the pond than above the pond.
- Detrital carbon below the pond was much finer-grained in size, as typified by the high percentage of collector/filter species.
- Periphyton density was greater above the pond than below it; however, algal species below the pond tended to be associated with eutrophic conditions.
- Leaf pack processing rates were sharply lower below the pond than above the pond
- Macroinvertebrate density was similar above and below the pond; however, the standing crop was slightly lower, and species diversity was sharply lower below the pond.
- Several pollution-sensitive taxa were eliminated below the pond, including all *Ephemeroptera*, *Plecoptera*, and *Odonata*. Non-insect forms predominated below the pond (tubificid worms and snails).



R0079898

**Table 5: Summary of Useful Techniques to Reduce Pond Impacts**

Site Problem	Recommended Pond Fingerprinting Techniques
Need to Avoid an Existing Wetland	<ul style="list-style-type: none"> <li>• Perform wetland delineation before locating pond</li> <li>• Select pond system with minimal permanent pool</li> <li>• Adjust pond configuration ("donut pond")</li> <li>• Install parallel pipe system to divert runoff around wetland to pond site further downstream</li> <li>• Construct a sequence of ponds around the wetland</li> </ul>
Need To Preserve Mature Forest or Habitat Area	<ul style="list-style-type: none"> <li>• Select pond system with micropool</li> <li>• Configure pond to minimize the removal of specimen trees</li> <li>• Limit the area of disturbance</li> <li>• Mandate tree protection measures during construction</li> <li>• Plant native tree and shrubs to replicate habitat functions lost due to pond</li> </ul>
Concern About the Thermal Impact of a Permanent Pool on Downstream Fishery	<ul style="list-style-type: none"> <li>• Split 50-75% of cooler baseflow above pond and bypass it around the permanent pool</li> <li>• Select pond system with minimal permanent pool</li> <li>• Use the infiltrator pond</li> <li>• Preserve existing shade trees, plant fast-growing shade trees along the shoreline/stream valley</li> <li>• Align pond in north-south direction</li> <li>• Avoid excessive rip-rapping and concrete channels that rapidly impart heat to runoff</li> <li>• Utilize deep-water release in the permanent pool</li> </ul>
Need to Protect Stream Reach Above Pond From Urban Stormflows	<ul style="list-style-type: none"> <li>• Install parallel pipe system along the upstream reach to convey excessive stormflows</li> <li>• Install plunge-pools at terminus of storm drains to reduce runoff velocities</li> <li>• Use bio-engineering techniques and checkdams to stabilize the stream reach</li> </ul>
Concern About Pond Effluent	<ul style="list-style-type: none"> <li>• Locate pond release within a foot of normal pool elevations</li> <li>• Dilute pond effluent during severe pond drawdowns and draining operations</li> <li>• Maximize reareation within riser, barrel and outfall</li> </ul>

stream channels. The extent of this sacrifice is closely related to the size and imperviousness of the contributing watershed to the pond.

*Influence of Ponds on the Fish Community*

Ponds are usually a final barrier to resident fish migration, and can prevent the recolonization of fish when upstream populations are severely impacted. Given the frequent stressors in degraded urban streams, it is quite likely that upstream fish populations may eventually become extinct. What is less appreciated is the influ-

ence that ponds have on downstream fish populations. Most larger ponds eventually establish a modest warm-water fish community due to the unregulated introduction of fish species by local fisherman. Typically, the fish community is quite similar to that of a farm pond, with the exception of some exotic species such as goldfish and koi. During storms, many of these warm-water species are washed downstream. Cummins (1990) has documented at least seven species of pond "escapees" that have become well established within the urban Anacostia stream network.



*Disturbance of Non-Tidal Wetlands and Forests*

Typically, the best location for a wet pond is at the lowest elevation of a development site, stream valley or floodplain. These same areas are likely to be wetlands and/or forest habitat. The traditional approach has been to construct an embankment across the stream to obtain the needed storage for a permanent pool, which can result in the complete inundation and eventual destruction of the wetland. Construction of stormwater ponds has been cited as the greatest single source of urban wetland destruction in the last two decades in several regions. In most cases, at least a portion of a proposed pond site will be considered as a wetland under the currently accepted unified federal method for wetland delineation, particularly if it is located on a perennial stream.

Non-tidal wetlands play an important role in maintaining the hydrology and water quality of urban streams. At the same time, uncontrolled stormwater severely degrades the quality of non-tidal wetlands. Thus, a pond siting strategy that seeks to totally avoid wetlands is self-defeating. A more realistic strategy is to fingerprint ponds above, around, or below wetlands, and in some cases, substitute stormwater wetlands for low quality

natural wetlands.

**Minimizing the Secondary Impacts of Ponds**

This section presents techniques for reducing or eliminating secondary impacts from stormwater ponds. These techniques include the selection of an appropriate pond system, fingerprinting, special pond design features, artificial wetland creation, and alternative conveyance. The techniques are summarized in Table 5.

*Selecting the Right Pond System*

The first step to reduce secondary pond impacts is to perform a careful field analysis of the development site and the stream prior to choosing a pond design. A complete delineation of wetlands, forest habitats and infiltration potential should be performed before any pond is designed or located. The stream evaluation should look at the temperature regime (cold, cold/cool, cool or warm water), as well as a biological survey to determine if any sensitive indicator organisms are present, such as trout.

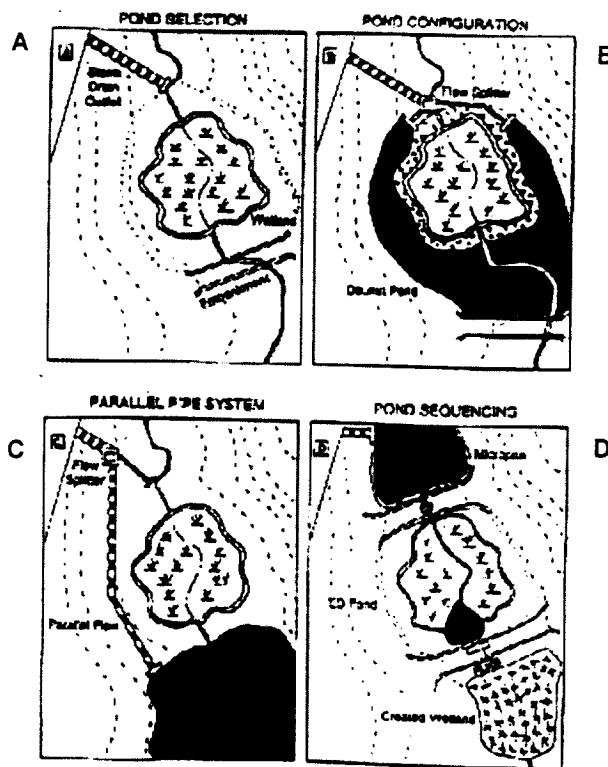

Panel A. Existing natural wetland is severely impacted by upstream stormwater inputs and frequent inundation.  
 Panel B. Existing wetland is protected by berm; stormwater bypassed to the two arms of the wet pond.  
 Panel C. Excess stormwater diverted around natural wetland to a more favorable location via a parallel pipe system.  
 Panel D. Stormwater penetrated before it reaches wetland, where temporary extended detention is provided. A downstream stormwater wetland is created to compensate for impacts to the existing wetland.

**Figure 3: Techniques for Fingerprinting a Stormwater Wetland Around a Natural Wetland**



R0079900

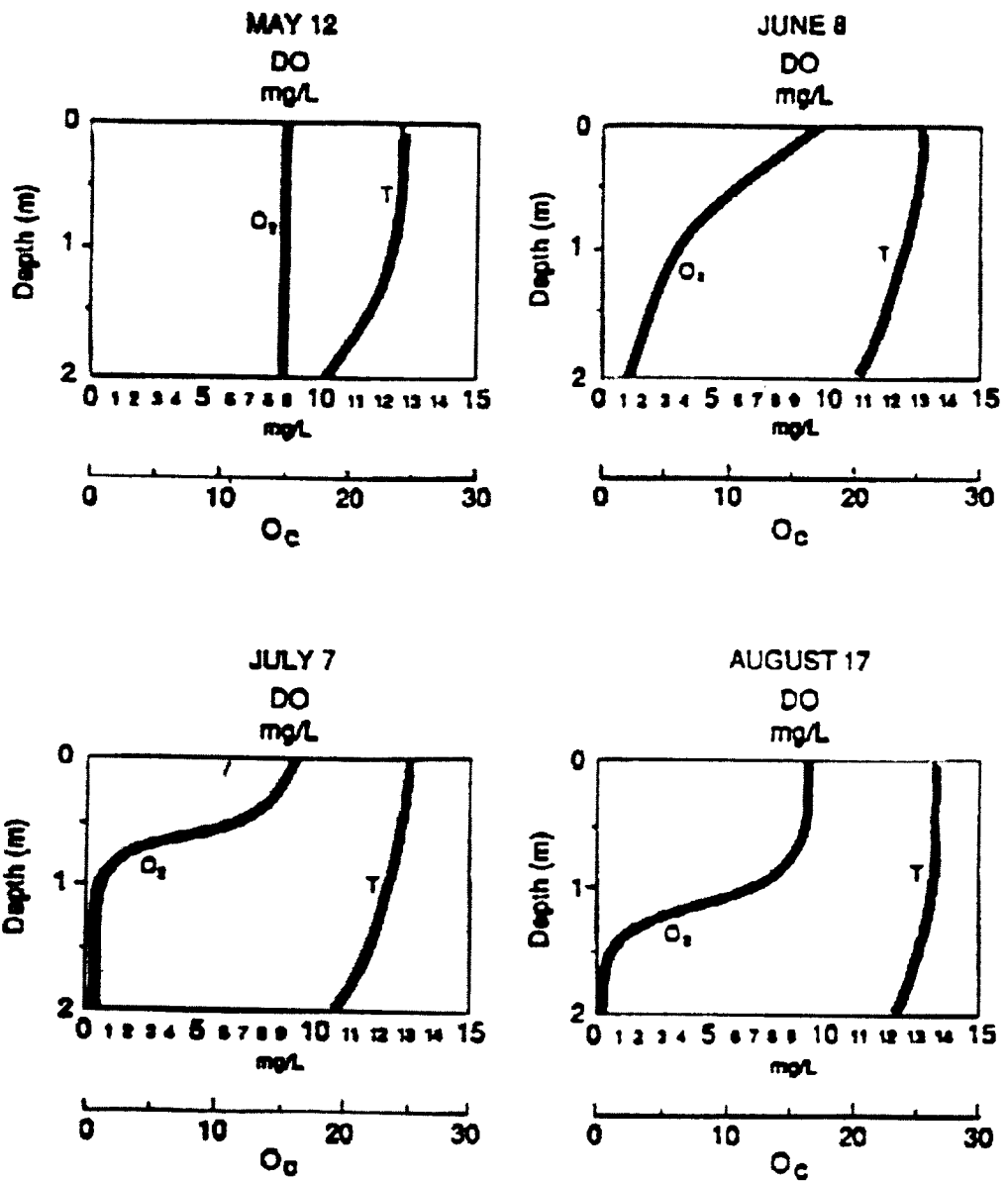

Figure 4: Profiles of Oxygen and Temperature in an Eight-Foot Deep Hypereutrophic Wet Pond in Maryland in the Summer (Galli, 1998)

In temperature-sensitive watersheds, the ED micropool pond is recommended since it is expected to have the smallest pond delta-T. Ponds that employ a deep permanent pool, or a large shallow marsh should generally be avoided in trout streams. The ED micropool design is also an excellent choice for fingerprinting a pond around a high quality wetland or a quality forest habitat.

#### Pond Fingerprinting

Pond fingerprinting is a broad term that refers to a series of techniques that can reduce the potential environmental impacts of ponds. Figure 3 illustrates several fingerprinting approaches that can minimize the impact of ponds on existing wetland areas.

Traditionally, ponds are located by constructing an embankment across the stream valley to create the required storage volume for a permanent pool. This results in the complete inundation and destruction of the wetland area. Designers should select a pond de-



sign that does not have a permanent pool. While this eliminates the need for a destructive permanent pool, it can cause a major hydrologic change to the existing wetland, due to the greater frequency of inundation or water level fluctuation.

A second option is to create a "donut" pond configuration (shown in Panel B). In this option, a flow splitter is installed at the terminus of the stormdrain system. At the same time, a berm is created around the existing wetland. A permanent pool is then excavated along the outside perimeter of the berm to provide the required storage. The flow splitter controls the flow to the entire system. The stream's baseflow is directed through the wetland to maintain its original hydrology; however, all stormflow is routed to the two upper arms of the permanent pool. The donut can sharply reduce impacts to the wetland.

A third option involves installing a parallel pipe system to divert stormflows around the existing wetland to a permanent pool situated further downstream (Panel C). Once again, a flow splitter is installed at the terminus of the storm drain to divert the stormflows and send the existing baseflow into the wetland to maintain its hydrologic regime.

A fourth fingerprinting option involves pond sequencing, i.e., employing a series of smaller pools and wetland areas along the stream valley, rather than a single large permanent pool. One such scheme is shown in Panel D. In this option, a three-cell pond system is used to obtain the total storage requirement, involving (a) a small permanent pool cell above the wetland, (b), a ED micropool cell within the wetland, and finally, (c), a created wetland cell below the existing wetland.

#### *Engineering Solutions to Reduce the Pond Delta-T*

A number of pond design techniques can be employed to reduce the magnitude of the delta-T of a pond. First, it is very important to shade pilot and outfall channels, using fast-growing riparian species such as willows and red-maple. The use of exposed rip-rap and concrete surfaces in ponds should be kept to a minimum.

Second, the volume of permanent pools should be reduced, with a greater reliance on extended detention storage. Pools can be aligned in a north-south direction, where possible. A portion of the incoming baseflow can also be split out above the pool and bypassed entirely around the pool area. This has been done with some success at the Rolling Stone pond in Maryland, but the bypass pipes and flow splitters do require constant maintenance.

Deepwater releases from ponds have been suggested as a method for reducing the delta-T. However, the value of the deep-water release is extremely limited for ponds less than 10 feet deep, as shown in Figure 4.

The plot shows the profiles of oxygen and temperature in an eight foot deep hypereutrophic wet pond in Maryland in the summer. While oxygen concentrations exhibited sharp stratification from top to bottom, the vertical stratification of water temperature was much less pronounced. The maximum temperature difference between the surface and bottom of the pond was less than five degrees F (it should also be noted that pond surface temperatures are often two to three degrees F higher than what is observed at the point of outflow for any pond with an underwater release). The Rolling Acres pond had a deep water release six feet below the pond surface, yet still experienced significant delta-T (Galli, 1988). Moreover, the oxygen and carbon concentrations discharged from the pond was of very poor quality during the summer months.

#### *Alternative Conveyance to the Pond*

The sacrifice of upstream reaches can be mitigated to some extent by the use of parallel pipe systems. In these systems, excess stormwater runoff is split from the storm drain before it is discharged into the stream, and is piped in a direction parallel to the stream before it is returned to the stream. Excess runoff is roughly defined as all storm flow runoff volumes from the six month storm up to the two-year event. A number of parallel pipe systems have been constructed in the Maryland suburbs, and most appear to be working effectively to protect sensitive stream reaches above ponds (see article 150).

#### *Wetland Creation*

Stormwater ponds have the potential to create additional areas of emergent and high marsh wetland. Contrary to popular belief, the potential quality and functional value of these artificially created wetland systems can be quite high. In actual practice, many stormwater wetlands have little diversity or structure, since they have uniform depth, and overemphasize the use of non-local emergent plants. Recent stormwater pond designs borrow heavily from experiences gained in wetland restoration, and emphasize complex shapes, irregular micro-topography, wetland mulch, and greater attention to the more diverse "high marsh" zone (Schueler, 1991).



### Concluding Thoughts: The Relative Importance of Primary and Secondary Impacts

Stormwater ponds remain the preferred and practical option for mitigating the impacts of uncontrolled stormwater runoff on streams and distant receiving waters. However, when ponds are designed and located with no regard for the immediate environment, they can produce a diverse array of potential negative impacts in sensitive streams. Consequently, designers should carefully assess the potential impact of stormwater ponds, and utilize pond fingerprinting to help avoid these impacts.

—TRS

### References

- Adams, L.W. L.E. Dove, D.L. Leedy, and T. Franklin. 1983. *Methods for Stormwater Control and Wildlife Enhancement: Analysis and Evaluation*. Urban Wildlife Research Center. Columbia, Maryland. 200 pp.
- Galli, F.J. 1988. *A Limnological Study of an Urban Stormwater Management Pond and Stream Ecosystem*. Masters Thesis. George Mason U. 153 pp.
- Galli, F.J. 1990. *Thermal Impacts Associated With Urbanization and Stormwater Best Management Practices in Maryland*. Anacostia Restoration team. Prepared for the Maryland Department of the Environment. 150 pp.
- Galli, F.J. and R. Dubose. 1990. *Water Temperature and Freshwater Stream Biota: An Overview*. Anacostia Restoration Team. Prepared for the Maryland Department of the Environment. 122 pp.
- Hartigan, J.P. 1986. "Regional BMP Master Plans." *Urban Runoff Quality: Impact and Quality Enhancement Technology*. B. Urbonas and L. Roesner, editors. American Society of Civil Engineers. pp. 351-365
- Maryland Department of the Environment. 1991. *Stormwater Management Infiltration Practices in Maryland: A Second Look*. Sediment and Stormwater Administration. 75 pp.
- Petts, G.E. 1984. *Impounded Rivers: Perspectives for Ecological Management*. John Wiley & Sons. New York. 326 pp.
- Pluhowski, E.J. 1970. *Urbanization and Its Effect on the Temperature of Streams in Long Island, New York*. U.S. Geological Survey Professional Paper 627-D. 110 pp.
- Schueler, T.R. 1987. *Controlling Urban Runoff: A Practical Manual for Planning and Designing Urban Best Management Practices*. Metropolitan Washington Council of Governments. 280 pp.
- Schueler, T.R. and M. Helfrich. 1988. "Design of Wet Extended Detention Pond Systems." *Design of Urban Runoff Controls*. L. Roesner and B. Urbonas, editors. American Society of Civil Engineers. New York.
- Schueler, T.R. and J. Lugbill. 1990. *Performance of Current Sediment Control Measures at Maryland Construction Sites*. Prepared for the Maryland Department of the Environment. Anacostia Restoration Team. 90 pp.
- Schueler, T.R. and F.J. Galli. 1990. "Pond/Marsh Detention System Key to Urban Stream Restoration." *Restoration and Management Notes*. 8(2):115-116.
- Schueler, T.R. 1991. *Design of Stormwater Wetland Systems*. Anacostia Restoration Team, Metropolitan Council of Governments. Washington, DC. 144 pp.
- Ward, J.V. and J.A. Stanford. 1979. *The Ecology of Regulated Streams*. Plenum Press. New York. 398 pp.
- Wiegand, C.W., W.C. Chittenden and T.R. Schueler. 1986. "Cost of Urban Runoff Controls." *Urban Runoff Quality: Impact and Quality Enhancement Technology*. B. Urbonas and L. Roesner (editors). American Society of Civil Engineers. pp 366-380.

# Pollutant Dynamics of Pond Muck

**H**istorically, most research on stormwater ponds has focused on the movement of pollutants into and out of the pond. This is quite understandable, as knowledge about inputs and outputs of pollutants helps to estimate pollutant removal performance. An impressive amount of input/output monitoring data has been collected: nearly 65 pond monitoring studies have been conducted in the U.S. and Canada.

Most of the monitoring studies have shown that stormwater ponds and wetlands are quite effective in trapping pollutants carried in urban stormwater. Much less is known, however, about the fate of stormwater pollutants once they are trapped in a pond. It is generally assumed that most of the pollutants eventually settle out to the pond bottom and form a muck layer. (The term **muck layer** is used here to distinguish newly-deposited bottom sediments from the older parent soils that formed the original pond bottom.)

The muck layer deepens as the pond ages. Pollutants may remain trapped within the muck layer until the entire layer is excavated during a pond clean-out. In most cases the muck is eventually dewatered, excavated, and applied back to the land surface. Research on bottom sediments in other shallow water systems, however, suggests that the muck layer may not be so inert. Figure 1 illustrates how a given pollutant can follow a number of diverse and complex pathways into and out of the muck layer.

Some runoff pollutants are transformed within the muck layer, while others are decomposed through chemical and microbial processes involved in sediment diagenesis. Indeed, diagenesis is often a key pathway for decomposition of organic matter and some nutrients. Alternatively, pollutants can migrate further below the muck layer and into the original soil profile. In some extreme cases, pollutants can travel into groundwater.

Alternatively, pollutants might enter the food chain while in the muck layer, either through uptake by wetland plants or by bottom feeding fish. Under the right conditions, some pollutants could also be released from the muck into the water column (where they could exit the pond during the next storm).

In this article, we examine the internal dynamics within the muck layer of stormwater ponds, based on an extensive review of research studies on the physical, chemical, and biological nature of the muck layer of over

50 stormwater ponds and wetlands. While it must be admitted that the study of muck is somewhat lacking in glamour, it can have many important implications for the design and operation of stormwater ponds and wetlands. Typical questions include:

- What is the average deposition rate of muck in ponds?
- After how many years of deposition will muck need to be removed?
- Can the deposition rate be used to calculate the size of the sediment forebay for a pond?
- How tightly are pollutants held in the muck layer?
- Is there any risk that pollutants could be released back into the water column? Or migrate into groundwater supplies? Or enter the aquatic food chain where toxicity might be magnified?
- If pollutants do remain in the muck layer, should muck be considered hazardous or toxic?
- Can muck be safely applied back on the land surface after it is cleaned out from the pond? Or are more exotic and expensive methods needed to safely dispose of muck?
- Finally, the depth of accumulated muck generally represents the long term work of a pond in trapping pollutants. Can the characteristics of pond muck allow us to infer anything about the pollutant removal processes operating in ponds or the land uses that drain to it? Can muck pollutant concentrations "fingerprint" upstream land uses?

To answer these questions, we reviewed bottom sediment chemistry data from 37 wet ponds, 11 detention basins, and two wetland systems, as reported by 14 different researchers. Although the studies covered a broad geographic range, almost 50% of the sites were located in Florida or the Mid-Atlantic states. Analysis was restricted to mean dry weight concentrations of the surface sediments that comprise the muck layer (usually the top five centimeters). The stormwater ponds ranged in age from three to 25 years.

## The Nature of Pond Muck

The muck layer can be easily distinguished from the parent soils that comprise the pond's original bottom.

**R0079904**

Figure 1: A Field Guide to the Muck Layer

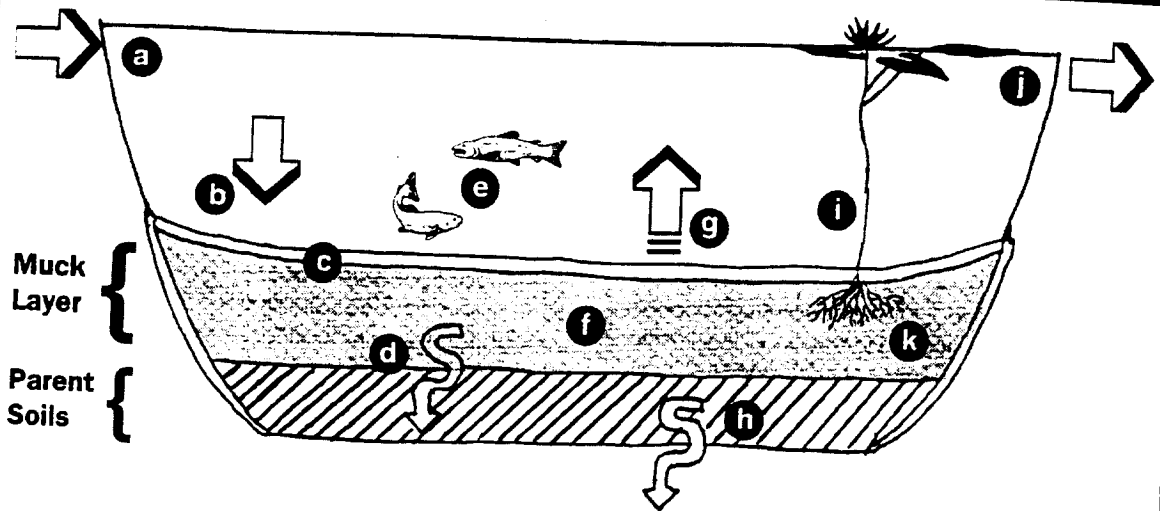

Pond muck represents a long term repository for the pollutants trapped within a stormwater pond. A pollutant, however, can take many different pathways through the mucklayer, as shown in the diagram above.

- a Pollutant inflow.** Sediment, nutrients, trace metals, and hydrocarbons enter the pond during each storm. The total pollutant load delivered to the pond depends to some degree on land use. Some evidence exists that metal and hydrocarbon loads are significantly greater from watersheds draining roads or industrial areas.
- b Sediment Deposition.** A steady rain of sediment particles, attached pollutants, and algal detritus forms the muck layer over time. Field measurements indicate that the muck layer grows from 0.1 to 1 inch per year, with greater deposition noted near the inlet.
- c Muck Microlayer.** The uppermost layer of muck represents the recently deposited sediments and pollutants. Consequently, it is very high in organic matter and constantly worked over by microbes, worms and other organisms.
- d Downward Migration.** Most pollutants are tightly bound to sediment particles and remain fixed within the muck layer. Other pollutants can migrate downward into the subsoil via pore spaces between sediment particles.
- e Fish Bio-magnification.** Bottom feeding fish that dwell in larger ponds, such as carp and catfish, ingest detritus from the muck layer. Not much is known about pollutants accumulating in their tissues over time.
- f Sediment Diagenesis.** Organic matter and nutrients are gradually reduced and decomposed over time in the muck layer through a process known as sediment diagenesis. Diagenesis is a key pollutant removal pathway that combines physical, chemical, and biological processes within the sediment to slowly break down organic matter, in the presence or absence of oxygen.
- g Phosphorus Release.** In the summer, low oxygen levels near the bottom of pond can induce a "burp" of soluble phosphorus, ammonia, or methane back into the water column. The potential for this phenomena is greatest in deeper ponds in warmer latitudes.
- h Groundwater Migration.** Pollutants not tightly bound to the pond muck can migrate downward through sediment pore spaces and ultimately reach the water table. Soluble pollutants, such as chloride and nitrate, are the most mobile and have been reported to migrate outward from ponds into groundwater at modest levels. Most monitoring studies, however, reveal little if any risk of groundwater contamination from stormwater pond muck.
- i Wetland Plant Uptake.** The roots of wetland plants take up both nutrients and metals from the muck layer and transport them upward to tubers, stems, and leaves. At the end of the growing season, this above-ground plant matter often dies off. Some of the nutrients are released back into the pond, while others settle back to the muck layer as detritus.
- j Pollutant Export from the Pond.** Pollutants remaining in the pond's water column will often flush out during the next storm event. Consequently, any pollutants that were released from the muck layer back into the water column may exit as well, thereby reducing the long term pollutant removal performance of the pond.
- k Sediment Clean-outs.** The ultimate removal of stormwater pollutants is accomplished when the muck layer is excavated from the pond and applied back on the land. This operation may need to be conducted every 25 to 50 years, depending on whether the pond has a forebay. Based on existing data and sediment quality criteria, pond muck does not usually constitute a toxicity hazard.

Distinguishing features include the following:

- **Very "soupy" texture**— 57% moisture; number of studies reporting (N) = 15
- **Distinctive grey to black color**
- **High organic matter content**— nearly 6% volatile suspended solids on average (N=16)
- **Low density** (about 1.3 gms/cm) (Dorman *et al.*, 1989)
- **Poorly-sorted sands and silts dominating the muck layer**

#### Deposition of Muck

Muck essentially represents the bulk of all sediments and pollutants that have been historically trapped within a pond (excepting those that are microbially broken down into gaseous forms or those pollutants that migrate below the pond). Therefore, the long term deposition rate of the muck layer is of great interest.

The annual deposition rate can be easily calculated if the age of the pond and the depth of the muck layer are known. The depth of the muck layer is relatively easy to estimate in the field, due to its unique physical characteristics. Annual muck deposition rates on the order of 0.1 to 1.0 inch per year have been reported for a series of ponds in Florida (Yousef *et al.*, 1991). These rates compare favorably with other pond sedimentation rates calculated at 0.5 inches/yr (Galli, 1993) and 0.8 inches/yr (Schueler, 1994) utilizing different techniques.

The deposition rate of muck is not always the same throughout a pond, however. The greatest rates tend to be observed near the inlets of wet ponds, and to some extent, the outlets of detention basins (Grizzard *et al.*, 1983). In addition, muck deposition rates increase sharply for ponds that are small in relation to the contributing watershed areas and for ponds that located directly in streams (Galli, 1993).

#### Nutrient Content of Pond Muck

As might be expected, the muck layer is highly enriched with nutrients (Table 1). Phosphorus concentrations in 23 ponds averaged 583 mg/kg (range 110 to 1,936 mg/kg, N=23). Nearly all the nitrogen found in pond muck is organic in nature, with a mean concentration of 2,931 mg/kg (range 219 to 11,200, N=20). Nitrate is present in extremely small quantities, which may indicate that some denitrification is occurring in the sediments, or perhaps merely that less nitrate is initially trapped in muck.

In the entire pond data set, the nitrogen to phosphorus (N:P) ratio of the muck layer averages about five to one, whereas the average N:P ratio for incoming stormwater runoff is typically around seven to one. This lower N:P ratio is not unexpected. Ponds are generally more

effective in trapping phosphorus than nitrogen and the decay rate for nitrogen in the muck layer is generally thought to be more rapid than for phosphorus (Avinmelich *et al.*, 1984).

Researchers have expressed concern that phosphorus trapped in the muck layer might be released back into the water column, particularly when oxygen levels are low in the summer. A number of investigators have observed hypoxic and even anoxic conditions near the muck layer in ponds as shallow as five feet deep (Galli, 1993; Yousef *et al.*, 1990).

An intriguing suggestion for possible sediment phosphorus release is evident in a handful of Florida ponds (Table 1). These ponds had unusually high N:P ratios of the muck layer, often in excess of 10 to one. One explanation for the apparent depletion of phosphorus in the muck layer would be the mobilization and release of phosphorus from recurring anoxia over many years.

Still, most of the more Northern ponds, as well as many Southern ones, appear to retain most of the phosphorus deposited in the muck layer. For example, phosphorus levels in the muck layer are 2.5 to 10 times higher than the soils underlying the pond bottom. Also, muck layer phosphorus levels do not normally decrease as ponds grow older.

#### Trace Metal Content of the Muck Layer

The muck layer of stormwater ponds is heavily enriched with trace metals. This phenomenon is consistent with reported performance data (Table 2). Trace metal levels are typically five to 30 times higher in the muck layer, compared to parent soils. Trace metal levels in the muck layer also follow a consistent pattern and distribution. (zinc > lead >> chromium = nickel = copper > cadmium).

This pattern is nearly identical to their reported concentrations monitored in urban stormwater runoff. It also suggests that rarely monitored (or detected) trace metals, such as chromium, copper, nickel, and possibly cadmium, are actually trapped by stormwater ponds. The muck layers of older ponds often contain more lead than zinc, whereas in younger ponds the converse is true. This may reflect the gradual introduction of lead-free fuels over the last decade, with the consequent reduction in lead loadings delivered to the younger ponds.

The trace metal content of the muck layer happens to be directly influenced by the type of land use that drains to it (Table 3). Muck layers in stormwater ponds that drain residential areas had the lightest metal enrichment. Commercial sites were subject to slightly greater enrichment, particularly for copper, lead, and zinc. Ponds that primarily served roads and highways were highly enriched with metals, presumably due to the influence of automotive loading sources (e.g., cadmium, copper, lead, nickel, and chromium).



**Table 1: Characteristics of the Muck Layer in Wet Stormwater Ponds (mg/kg Dry Weight Unless Otherwise Noted)**

Location	Land Use	% Moisture	% Volatile Suspended Solids	Total Kjeldahl Nitrogen	Total Phosphorus	Nitrogen to Phosphorus Ratio	Hydrocarbons
FL	Road	63	7.1	5180	510	10:1	
FL	Road	77	10.2	4140	301	14:1	
FL	Road	50	9.7	3110	1116	3:1	
FL	Road	60	6.8	1130	100	11:1	
FL	Road	52	6.5	2290	270	9:1	
FL	Road	62	4.5	1440	370	4:1	
FL	Road	65	4.8	2070	480	4:1	
FL	Road	60	4.3	2110	110	20:1	
FL	Road	76	10.4	11200	420	26:1	
FL	Residential	33	2.4	889	292 #	3:1	
FL	Road	64		2306 *	3863	0.6:1	
FL	Residential		6.4	624	619	1:1	
FL	Residential		1.1	256	389	0.7:1	
FL	Commercial		4.1	5026	1936	3:1	
FL	Road				1100		
VA	Residential		4.3	828	232	4:1	
NZ	Industrial			2471	995	3:1	12892
NZ	Residential			5681	1053	5:1	2087
MN	Residential	70	9.5		405		
MN	Residential	32	4.8		606		
MN	Road	51		3271	695	5:1	
CT	Road	32		219	499	0.4:1	
MD	Institutional			11000	917	12:1	474
<b>MEANS</b>		<b>57</b>	<b>6.0</b>	<b>2931</b>	<b>583</b>	<b>5:1</b>	

\* = Total Nitrogen

# = May have been influenced by fuel spill

Although the sample size was small (N=2), industrial catchments had, by far and away, the greatest level of trace metal enrichment in the muck layer of any land use. Clearly, further monitoring of heavily industrial catchments is warranted to confirm if muck enrichment represents a problem.

Most trace metals are very tightly fixed in the muck layer and do not migrate more than a few inches into the soil profile. Many researchers have examined soil cores to determine the distribution of trace metal concentration with depth. A consistent pattern is noted. Trace metal levels are at their maximum at the top of the surface layer, and then decline exponentially with depth. Eventually they reach normal background levels within 12 to 18 inches below the pond. Representative sediment metal profiles are shown in Figure 2.

Although the muck layer is highly enriched with metals, it should not be considered an especially toxic or hazardous material. For example, none of over 400 muck layer samples from any of the 50 ponds sites examined in this study exceeded current EPA's land application criteria for metals (Giesy and Hoke, 1991)

(Table 2). In fact, metal levels in the muck layer are usually less than 10 times higher than the national mean for agricultural soils in the U.S. (Holmgren *et al.*, 1993) (Table 4).

Of perhaps greater interest is whether soluble metals can easily leach from the muck layer where they could exert a biological or groundwater impact. The capacity for metals to leach from sediments is measured by EPA's Toxicity Characteristics Leaching Procedure (TCLP). The TCLP test, or a slight variant, has been applied by four different investigators to pond muck (Dewberry and Davis, 1990; Harper, 1988; Yousef *et al.*, 1990, 1991) with much the same result—usually less than 5% of the bulk metal concentration is susceptible to leaching.

In general, cadmium and zinc exhibited the greatest potential for leaching (usually less than 10%) while copper and lead showed little or no leaching potential. Moreover, leachate concentrations seldom exceeded the mean metal concentrations reported for urban stormwater runoff.

**Table 2: Trace Metal Content in the Muck Layer of 50 Stormwater Ponds and Wetlands (mg/kg dry weight)**

Practice	Location	Land Use	Cadmium	Copper	Lead	Zinc	Nickel	Chromium
WP	FL	Residential	4.8	13	38.2	35.7	10.8	4.8
WP13	VA	Mix	3.2		45.3			25
WP	VA	Residential	0.8	17.2	48	78	12.2	
WP	NZ	Industrial		173	578	3171		
WP	NZ	Commercial		18.2	48.9	146		
WP9	FL	Road	15	28	374	161	52	61
WP	MD	Institutional	12	130	202	904		120
WP	MN	Residential			32.9			
WP	MN	Residential			17.0			
WP	OR	Institutional		60.2				
WP	CT	Road	0.4	19	39	53		13
WP	FL	Road	ND	13	125	105		31
WP	MN	Road	ND	57	139	261		51
WP	FL	Road	6	49	620	250		20
WP	FL	Residential	1.5	7	11	6	3	6
WP	FL	Residential	0.6	2	12	11	4	12
WP	FL	Commercial	2.7	6	42	103	6	11
SM	MN	Residential			82			
SM	MN	Residential			56			
DPSM	MD	Industrial	12	140	400	1098		
EDP	MD	Residential	0.4	8	223	45		
DP	VA	Commercial	1.7	30	748	202		
DP8	VA	Residential	3.0		50		30	
EPA land application criteria			380	3300	1600	8600	990	3100

KEY: WP = Wet pond; SM = Shallow marsh; DPSM = Detention basin with shallow marsh; DP = Detention basin; EPA = Maximum metal limits for land application

### Hydrocarbon Content in Muck

One aspect of the muck layer that has yet to be well explored is the potential for hydrocarbons and PAH contamination. The limited data on hydrocarbon levels in the muck layer (Table 1) are a cause for some concern, particularly at an Auckland, New Zealand industrial site. Gavens *et al.* (1982) reported that the concentration of total PAH and aliphatic hydrocarbons in the muck layer of a 120 year old London basin were three and 10 times greater, respectively, than the parent sediments. Only limited biodegradation of hydrocarbons trapped in the muck appeared to have occurred in the basin in recent years. Yousef (1994) on the other hand, reports that hydrocarbons were rarely detected in the muck of Florida ponds.

### Aquatic Community

A soupy substrate, high pollutant load, and periodically low oxygen level render the muck layer a rather poor habitat for aquatic life. Macroinvertebrate sampling conducted by Yousef *et al.* (1990) and Galli (1988) indicate that the muck layer community has poor diversity and characteristics of high pollution stress. Chironomid and tubificid worms comprised over 90% of all organisms counted in a Florida pond muck layer, and dipteran midge larvae constituted 95% of all organisms collected in the muck layer of a Maryland pond. While the diversity of the community is extremely low, the benthic population can become very dense at certain times of the year. This is not surprising, given that extensive microbe population that uses the highly organic muck layer as an attractive food source.

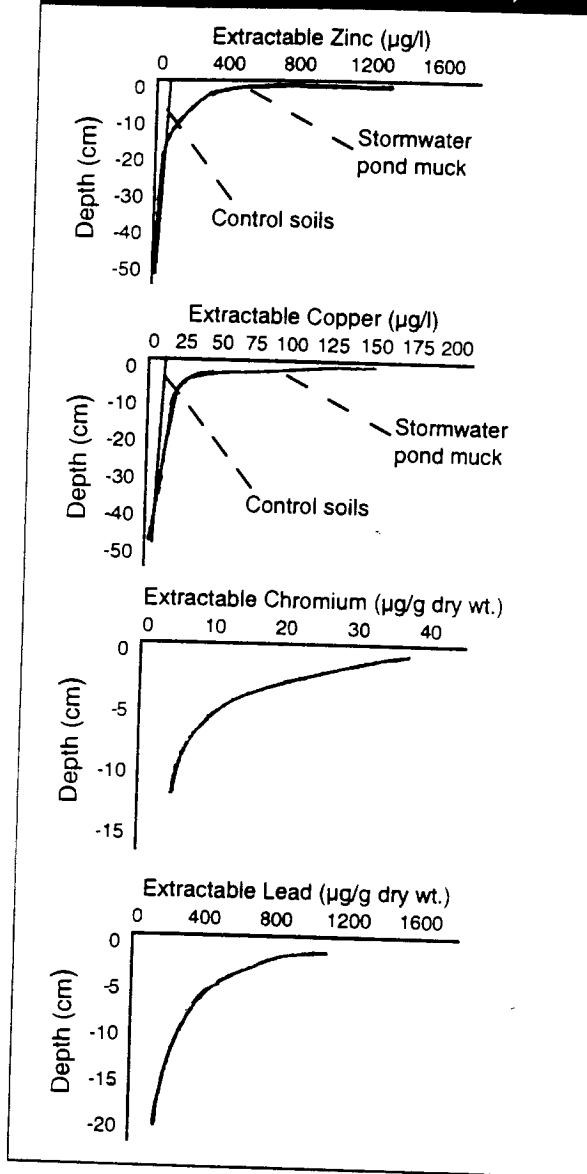

**Table 3: The Effect of Land Use on Trace Metal Concentrations in the Muck Layer (mg/kg)**

Land Use	No. of Sites	Cadmium	Copper	Lead	Zinc	Nickel	Chromium
Residential	18	2	9.4	44	35	8	31
Commercial	5	2	18	214	150	6	22
Road	13	11	30	330	163	52	51
Industrial	2	—	157	489	2135	—	—

R0079908

**Figure 2: Metal Profiles With Depth (Grizzard et al., 1983; Yousef et al., 1991)**



**Comparison of Pond Muck to Sediments Trapped in Other Stormwater Practices**

How does pond muck compare to the sediments trapped in other stormwater practices? Table 4 shows that the metal content of the muck layer of wet ponds and stormwater wetlands is quite similar to concentrations seen in the soils of "dry" detention basins. The metal content of pond muck and grassed swale soils are also quite similar in most respects, although swale soils tend to have about twice as much phosphorus and lead as their pond counterparts. Sediments trapped within the filter bed and sedimentation chamber of sand filters also appear to be generally comparable to pond muck, although only one sand filter has been sampled to date (Shaver, 1991).

The one stormwater treatment practice that sharply departs from this pattern is the oil grit separator (OGS). The metal content of trapped sediment within OGSs is five to 20 times higher than other stormwater practices, particularly if the OGS drains a gas station (Schueler and Shepp, 1993). Hydrocarbon and priority pollutant levels in OGS sediments are also much higher.

This condition reflects the fact that OGSs often exclusively serve hydrocarbon hotspots and are designed to trap lighter fractions of oil (Schueler, 1994). It is doubtful that metal and hydrocarbon levels in pond muck could approach the level seen in OGSs, since they typically drain larger watersheds that dilute the influence of individual hydrocarbon hotspots.

**Implications for Pond Design and Maintenance**

An understanding of the dynamics of the pond muck layer has many implications for the design and maintenance of stormwater ponds.

*Pond Clean-out Frequency*

Based on observed muck deposition rates, stormwater ponds should require sediment clean-out on a 15 to 25 year cycle (Schueler, 1994; Yousef et al., 1991). For

**Table 4: Comparative Metals Concentration in Stormwater Practice Sediments (mg/kg) Dry Weight**

Practice	No. of Observations	Cadmium	Copper	Lead	Zinc	Nickel	Chromium
Wet pond	38	6.4	24.5	160	299	38	36
Detention Basin	11	4	59	161	448		30
Grassed swale	8	1.9	27	420	202	13	30
Oil grit separator	13	14	210	320	504		284
Oil grit separator <sup>a</sup>	4	36	788	1198	6785		350
Sand filter	1	1.3	43	81	182	30	30
Sand filter <sup>b</sup>	1	4.6	71	171	418	49	52
Agricultural soils <sup>c</sup>	3000	0.28	30	12	56	24	
Resid. yards	9	0.1	5	13	9		

Notes: a = Oil Grit Separator, serving gas stations    b = Sand filter with sedimentation chamber  
 c = Holmgren et al., 1993



example, using a 0.5 inch/year muck deposition rate, and assuming that the muck consolidates over time as it deepens, up to 15 to 25% of pond depth can be lost over a 25 year period. The loss of capacity would be faster if construction occurs in the contributing watershed over this time period.

Most ponds are now designed with a forebay to capture sediments. A common forebay sizing criteria is that it constitutes at least 10% of the total pool volume. Based on a 0.5 inch/yr muck deposition rate, and the *untested* assumption that a forebay traps 50% of all muck deposited in the pond, the forebay could lose 25% of its capacity within five to seven years. At the same time, the sediment removal frequency for the main pool might be extended to about 50 years. These calculations assume that turbulence in the forebay does not cause muck to be resuspended and exported to the main pool. To meet this critical assumption, the forebay must be reasonably deep (four to six feet) and have exit velocities no greater than one foot/second at the maximum design inflow.

#### *The Proper Disposal of Muck*

All of the available evidence strongly argues that pond muck does not constitute a hazardous or toxic material. Thus, it can be safely land-applied with appropriate techniques to contain any leachate as it dewater. The high organic matter and nutrient content of pond muck might even make it useful as a soil amendment. Chemical testing of pond muck prior to land application is probably not needed for most residential and commercial sites, given the consistent pattern in the distribution of pond data reviewed in this paper.

Greater care should probably be exercised when disposing of pond muck from industrial sites and perhaps some heavily travelled highways. Although only a few industrial sites have been sampled so far, the data suggests these sites may pose a risk. In addition, there is a much greater chance of pollutant spills, leaks, or illegal discharges occurring in a pond over the 20 or 25 year time span in between clean-outs. It would seem prudent, therefore, to require prior testing at selected industrial and roadway ponds to reduce this risk.

#### **Further Research Into the Muck Layer**

While our emerging understanding about the muck layer is probably sufficient to make reasonably good management decisions regarding clean-outs and disposal, further research on muck layer dynamics is needed in several areas.

- Ponds need to be sampled to verify the deposition rate of muck over a broader range of geographic and regional conditions. Based on this data a predictive model of muck deposition rates could be developed to help practitioners who design and maintain ponds.

- Much more data needs to be collected concerning the accumulation of hydrocarbons and PAHs in the muck layer, particularly in ponds draining roads and industrial sites. Further testing of the muck layer for these compounds would give managers greater confidence about the proper method for muck disposal, as well as providing inferences about how well stormwater ponds can trap these key pollutants.
- The significance of muck layer phosphorus release as a factor in reducing the long term pollutant removal performance of a stormwater pond remain an open question. Perhaps direct, in-situ measurements of phosphorus flux in a stormwater pond, such as those used for many years in estuarine studies, could help resolve this issue.
- So far, few researches have explored the possible risk of pollutant bio-magnification in the muck layer, either by wetland plant uptake or by bottom feeding fish. A systematic sampling program to define pollutant levels in plant and animal tissue in a large population of stormwater ponds and wetlands would help assess the nature of this risk. Such a survey would also provide helpful guidance to designers on the issue of whether efforts should be made to attract wildlife to these systems.

—TRS

## References

- Avinmelich Y., J. McHenry and J. Ross. 1984. "Decomposition of Organic Matter in Lake Sediments." *Environmental Science and Technology*. 18(1):5-11.
- Dewberry and Davis, Inc. 1990. *Toxicity of Sediments from BMP Ponds*. Final Report. Northern Virginia Planning District Commission. 42 pp.\*
- Dorman, M., J. Hartigan, R. Steg and T. Quaserbarth. 1989. *Retention, Detention and Overland Flow for Pollutant Removal from Highway Stormwater Runoff*. Federal Highway Administration. Report No. RD-89-202. 179 pp.\*
- Fish, W. 1988. *Behavior of Runoff-Derived Metals in a Well-Fined Paved Catchment/Retention Pond System*. Water Resources Research Institute Report No. 103. Oregon State University. 54 pp.\*
- Galli, F. 1988. *A Limnological Study of an Urban Stormwater Management Pond and Stream Ecosystem*. M.S. Thesis. Department of Biology. George Mason University. Fairfax, VA.
- Galli, F. 1993. *Analysis of Urban Best Management Practice Performance and Longevity in Prince George's County, Maryland*. 202 pp.
- Gavens, A., D. Revitt and J. Ellis. 1982. "Hydrocarbon Accumulation in Freshwater Sediments of an Urban Catchment." *Hydrobiologia*. (91): 285-292.
- Giesy, J. and R. Hoke. 1991. "Freshwater Sediment Quality Criteria: Toxicity Bioassessment." in *Sediments: Chemistry and Toxicity of In-Place Pollutants*. R. Baudo, J. Geisy, and H. Muntau, Editors. Lewis Publishers.
- Grizzard, et al. 1983. *Final Monitoring Report for Washington Metropolitan Area Nationwide Urban Runoff Project*. Chapter 7. Occuquan Watershed Monitoring Lab. Metropolitan Washington Council of Governments. 366 pp.\*
- Grizzard, T. 1989. Memorandum dated 22 March 1989. *Detention Basin Spoil Disposal Near Twin Beech Court*. OWML. Manassas, Virginia. 5 pp.\*
- Harper, H. 1988. *Effects of Stormwater Management Systems on Groundwater Quality*. Final Report. Environmental Research and Design, Inc. Florida Department of Environmental Regulation. 460 pp.\*
- Holmgren, et al. 1993. "Cadmium, Lead, Zinc, Copper and Nickel in Agricultural Soils (USA)." *Journal of Environmental Quality*. 22: 335-348.
- Leersnyder, H. 1993. *The Performance of Wet Detention Basins for the Removal of Urban Stormwater Contaminants in the Auckland (NZ) Region*. M.S. Thesis. Dept. of Environmental Science and Geography. University of Auckland. 118 pp.\*
- Oberts, G and R. Osgood. 1988. *Final Report on the Function of the Wetland Treatment Systems and the Impacts on Lake McCarrons*. Metropolitan Council. Publ. No. 590-88-095. 94 pp.\*
- Oberts, G., P. Notzka and J. Hartsoe. 1989. *The Water Quality Performance of Selected Urban Runoff Treatment Systems*. Metropolitan Council. Publ. No. 590-89-062(a).\*
- Schiffer, D. 1989. *Effects of Highway Runoff on the Quality of Water and Bed Sediments in Two Wetlands in Central Florida*. U.S. Geological Survey Publication No. 88-4200. Florida Dept. of Transportation.\*
- Schueler, T. and D. Shepp. 1993. *The Quality of Trapped Sediments and Pool Water Within Oil Grit Separators in Maryland*. MWCOG. Maryland Department of Environment. 42 pp.\*
- Schueler, T. 1994. "Hydrocarbon Hotspots: Can They Be Controlled?" *Watershed Protection Techniques*. (1)1: 3-5.
- Schueler, T. 1994. *Design of Stormwater Pond Systems*. Center for Watershed Protection. Ellicott City, MD
- Shaver, E. 1991. *Sand Filter Design for Water Quality Treatment*.\*
- Wigington, P., C. Randall, and T. Grizzard. 1986. "Accumulation of Selected Trace Metals in Soils of Urban Runoff Swale Drains." *Water Resources Bulletin*. 22(1):73-79.\*
- Yousef, Y., M. Wanielista, J. Dietz, L. Yin and M. Brabham. 1990. *Final Report-Efficiency Optimization of Wet Detention Ponds for Urban Stormwater Management*. University of Central Florida. Florida Dept. of Environmental Regulation. 200 pp.\*
- Yousef, Y., L. Lin, J. Sloat and K. Kaye. 1991. *Maintenance Guidelines for Accumulated Sediments in Retention/Detention Ponds Receiving Highway Runoff*. University of Central Florida. Florida Dept. of Transportation. 210 pp.\*
- Yousef, Y. 1994. Personal communication. University of Central Florida, Orlando.

\* References with an asterisk were used to compile tables 1, 2 and 4.

R0079911

## Article 81

Technical Note #66 from *Watershed Protection Techniques*, 2(1): 302-303

# The Pond Premium

**R**eal estate agents and homeowners have long been aware of the "waterfront effect." A home situated near a stream, lake or river usually costs more to buy or rent than a more distant one. A waterfront location can translate into an extra charge or premium of nearly 30%. Does a similar effect exist for such artificial water features such as a stormwater pond or wetland? If a waterfront effect exists for these stormwater practices, it would have several important implications. For example, a strong effect could help a developer recoup some or all of the costs involved in designing and constructing a stormwater treatment practice for the site. Also, the notion that stormwater ponds could actually increase property value (and the local tax base) is a compelling justification for skeptical communities to adopt that stormwater quality requirements. The key question, then, is how great is the waterfront effect and how long does it last?

The U.S. Environmental Protection Agency (EPA) recently examined the issue by conducting a broad survey of real estate agents and developers that were involved in selling or leasing property featuring either well-designed stormwater ponds or constructed wetlands. Nearly twenty case studies were compiled, which compared the price or rents charged near stormwater

ponds with similar units located further away. Some of the key findings are illustrated in Tables 1 and 2. As a general rule, a premium of five to 30% existed for homes, apartments and offices with a view of a well-designed pond or wetland, with an average premium of about 10%. As might be expected, this premium is not as great as those charged for natural waterfront locations, but it is still substantial—averaging about \$10,000 per single family home. The premium also appears to hold up well upon reselling.

Two of the case studies tracked the resale value of homes near ponds for up to two decades, and found the premium held up or even increased as time went by. For apartment space, the pond premium typically amounted to \$10 per month for each unit. A pond premium was also evident in the commercial office space market, with a typical premium in the range of \$1.00 to \$1.50 per square foot. Even in soft or overbuilt real estate markets, the authors often found that a presence of a pond helped to sell space or units more rapidly, which has can provide developers a clear cash flow benefit. While the study primarily examined the waterfront effect associated with wet ponds, it did include two case study examples involving stormwater wetlands. In this limited sample, stormwater wetlands were also found

Table 1: Residential Lot Premium for Stormwater Ponds and Wetlands

Location	Base lot costs	Estimated premium
Alexandria, VA	\$130,000 to 140,000 condos	\$7,500
Fairfax, VA	\$333,000 to 368,000 homes	\$10,000
Burke VA	\$130,000 to 160,000 townhomes	\$10,000
Orange County, VA	varies	\$49,000
Fauquier County, VA	\$289,000-305,000 homes	\$10,000
Loudon County, VA	varies	\$7,500 to 10,000
Broward County, FL	\$0.1 to 1.1 million homes	\$6,000 to 60,000
Broward County, FL	varies	\$200 to \$400 per linear foot
Hybermia, IL	\$299 to 375,000 homes	\$30,000 to 37,500
Wichita, KS (wetland)	\$35,000 to 40,000 lots	\$20,000
Boulder, CO (wetland)	\$130,000 lots	\$35,000

00

R0079912

**Table 2: The Pond Premium for Rental Properties**

Location	Rental Type	Premium
Reston, Va	Apartment	\$10/month
Greenbelt, VA	Apartment	\$15/month
Waldorf, MD	Apartment	\$5 to 10/month
Mitchellville, MD	Apartment	\$10/month
Laurel, MD	Apartment	\$10/month
St Petersburg, FL	Apartment	\$5 to 35/month
Fairfax, VA	Comm. Office Space	\$1/sq. ft.
Prince Georges, MD	Comm. Office Space	\$1 to 1.50/sq. ft.

Source: U.S. EPA, 1995.

to have a strong waterfront effect. This appears to reflect a recent trend among many housing consumers to prefer a more natural appearance of their community.

The authors noted several factors that contributed to the size of the pond premium. Foremost among these is the size of the pond or wetland. In most of the case studies, ponds had a surface area of several acres or more. A second key factor was the addition of relatively low cost aesthetic or recreational amenities to the design of the pond. Many of the ponds included fountains, footpaths, bike trails or gazebos in their design, and all featured attractive pondscaping and landscaping.

It should be clearly noted that not all stormwater ponds will automatically generate a premium. In particular, it is doubtful whether smaller ponds (e.g. less than an acre) will produce a significant premium. Also, some home-buyers may perceive that steep-sided or deep wet ponds are a safety risk for young children and avoid them. Fencing may reduce the risk, but also tends to diminish the very aesthetic and recreational qualities that produce the pond premium.

Poor maintenance should also reduce the premium, particularly to the extent that it results in an unsightly, overgrown or stagnant pond. Lastly, developers themselves have reduced the pond premium in their decisions on where to locate the pond. A common practice over the years has been to relegate ponds to some hidden place in the back of a development where they are out of sight and out of mind (and consume as few lots as possible). The case studies clearly show that the

a pond premium can only be achieved when designers make the pond a prominent and integral feature of their residential or office development.

The EPA study provides further evidence that some environmental regulations can produce economic benefits to developers, property owners and even local governments. The existence of the pond premium is a strong incentive for developers to incorporate more attractive stormwater ponds and wetlands into their projects and to properly maintain these structures. These economic benefits are particularly important in an era of regulatory reform. In this respect, state and federal permitting agencies may wish to reexamine their policies with regard to ponds. In some regions of the country, these agencies have actively discouraged the construction of larger stormwater ponds that produce the greatest premium, on the grounds that they might produce downstream environmental impacts. A more balanced approach may be needed in order to realize the economic benefits, and produce more widespread application of stormwater controls. See also **article 84**.

—TRS

**Reference**

U.S. EPA. 1995. *Economic Benefits of Runoff Controls*. Office of Wetlands, Oceans, and Watersheds. Washington, DC. Publ. 841-S-95-002. 19pp.

**R0079913**

# Water Reuse Ponds Developed in Florida

Stormwater runoff can become a valuable water resource in many regions of the country. This novel perspective has led to the development of *water reuse ponds*. The basic principles are quite simple. Stormwater runoff is captured and stored in a pond, and then pumped back out to irrigate pervious areas in the contributing watershed. These areas can include golf courses, cemeteries, landscaping, community open space, and turf areas.

The design is similar in many respects to a wet extended detention (ED) pond. Each has four distinct storage components: sediment/forebay storage, flood control storage, pool storage, and temporary storage. The key difference is that in water reuse ponds, temporary storage is gradually pumped out for irrigation, whereas in wet ED ponds, it is gradually released downstream over a 24-hour period. During an extended dry weather period, continued pumping of the water reuse pond can draw down water levels in the permanent pool.

Water reuse ponds have several key environmental and economic benefits. The greatest benefit is the increased pollutant removal and groundwater recharge that occurs because a large fraction of the annual stormwater runoff volume (and pollutant load) are applied back to the watershed. Consequently, water reuse ponds are expected to achieve even greater mass pollutant removal rates than standard stormwater ponds. Without reuse, ponds cannot reduce the volume of runoff delivered downstream, and must rely exclusively on pollutant removal pathways within the pond to capture and treat stormwater pollutants.

Water reuse ponds are also a particularly useful design option where the water table is close to the land surface. Continuous pumping helps maintain storage capacity that would otherwise be lost due to groundwater intrusion.

The key economic benefit of water reuse ponds is that they are a relatively cheap source of irrigation water, when compared to the cost of potable water supplies. For example, Wanielista and Yousef (1993) calculate that the cost of irrigating a 100-acre, 18-hole golf course (two inches per week) may cost the operator nearly \$300,000 a year if potable water is used. In contrast, the annual irrigation cost of pumped stormwater from a water reuse stormwater pond was seven times lower (about \$40,000/year).

Two questions are often asked about water reuse ponds:

- How much stormwater storage is needed to assure a reliable irrigable water supply?
- How much stormwater runoff actually leaves the pond? Put another way, is it possible to design a "zero-discharge" pond?

To answer these questions, Wanielista and his colleagues simulated a water reuse pond in Florida using 15 years of daily rainfall, runoff, reuse, and pond discharge data. The heart of the model is a pond water balance that computes changes in incoming runoff, groundwater, direct rainfall to the pond, irrigation, pond outflow, storage, evapo-transpiration, and other hydrologic terms.

The model accurately simulated the actual performance of a monitored water reuse pond in Orlando, Florida. It was then used to construct a series of rate-efficiency-volume (REV) curves. These curves are a helpful aid in designing water reuse ponds. While REV curves are presently available only for Florida, the basic modeling approach is transferable to other regions of the country.

An analysis of the Florida curves suggest that water reuse ponds can provide a reliable source of irrigable water over the long term if a sizeable reuse volume is provided (often in excess of the local water quality volume). At this size, as much as 50 to 90% of the incoming runoff will be recycled back on the land, depending on the irrigation rate.

Water reuse ponds do have a few drawbacks. For example, they require a greater degree of operation than other stormwater practices, as well as the presence of a nearby customer for irrigation water. Also, reuse ponds may not be appropriate in sensitive streams, as continued pumping could diminish or eliminate downstream flows needed to sustain aquatic life. Nevertheless, they are a potentially useful pond design option in many climatic regions where irrigation is needed in urban areas on a seasonal or year-round basis. —TRS

### Reference

Wanielista, M. and Y. Yousef. 1993. "Design and Analysis of an Irrigation Pond Using Urban Stormwater Runoff." *Engineering Hydrology*. C. Kuo (ed.) ASCE. New York, NY. pp. 724-730.

82

R0079914

## Article 83

Technical Note #88 from *Watershed Protection Techniques*, 2(3): 450-452

# Trace Metal Bio-Accumulation in the Aquatic Community of Stormwater Ponds

Stormwater managers have always been concerned that pollutants trapped in stormwater pond sediments could re-enter the aquatic food web. Prior research has demonstrated that trace metals and hydrocarbons are taken up and incorporated into the tissues of wetland plants. Is there also a risk that pond macro-invertebrates can take up metals trapped in pond sediments? Can they ultimately move upward in the food web into the fish and wading birds that feed on them? If so, is the metal bio-accumulation great enough to warrant concern about toxicity? Is it safe to eat fish that are caught from stormwater ponds? Does it make sense to design stormwater ponds to attract wildlife? Two recent studies begin to shed some light on these troubling questions.

Karouna-Reiner conducted comprehensive macro-invertebrate surveys at 18 stormwater ponds and wetlands in suburban Maryland over a one-year period. Most of the ponds were a half-acre to one-acre in size, and most were constructed within five years of the study. All had a permanent pool up to six feet deep; many also contained extensive emergent wetlands. The pond's contributing watersheds were dominated by either commercial, residential or industrial land uses. In addition, Karouna-Reiner selected two constructed ponds that did not receive urban runoff to serve as reference controls. During the course of her year-long study, Karouna-Reiner monitored trends in the pond macro-invertebrate community in the littoral zone and sampled metals in pond water, sediments and macro-invertebrate tissue. In addition, she designed a bioassay system to test for toxicity in a sensitive amphipod, *Hyallela azteca*, exposed to typical stormwater pond sediments over a 10-day period.

In general, the sediment macro-invertebrate community in stormwater ponds was dominated by snails, midges, damselflies, skimmers, backswimmers and various diving and crawling beetles. Although diversity in individual stormwater ponds was quite variable, the pond macro invertebrate community was only slightly degraded in comparison to the reference ponds, according to two biological metrics, and was not different according to two others (abundance and percent chironomids - see Table 1). Statistical analysis also showed that the type of land use had no influence on the diversity of the pond community. Much of the variability in diversity was attributed to differences in wetland coverage and hydrology among the ponds. The stormwater pond macro-invertebrate community was more diverse than those sampled by Galli (1988) and Yousef *et al.* (1991) (both of whom concentrated more on the composition of deeper water sediments).

Karouna-Reiner detected copper, lead and zinc, and occasionally cadmium in the tissues of snails, damselflies, and a composite sample of other macro-invertebrates collected from the stormwater ponds (Table 2). While clear bio-accumulation was noted for copper, zinc and cadmium, the metal levels found in sediments and macro-invertebrate were generally within, or reasonably close to those for other unpolluted pond and wetland systems. In addition, the bioassay work did not indicate any acute toxicity for the amphipod, *H. azteca*, that were exposed for 10 days.

Campbell (1995) investigated trace metal levels in sediment and fish tissue in seven stormwater ponds in located in Central Florida. He studied three fish species that had different feeding habits: the bottom-feeding redear sunfish (*Lepomis microlophus*), the predatory

Table 1: Comparison of Macro-Invertebrate Diversity in Stormwater and Reference Ponds (Karouna-Reiner, 1995)

Pond Diversity Metric	Stormwater Ponds	Reference Ponds
	N = 18	N = 2
Taxa Richness	15.8	18.6
EPOT *	5.17	6.33
Abundance	247.1	229.72
Percent chironomids	10 %	15.5 %

\* taxa richness of *Ephemeroptera*, *Plecoptera*, *Odonata* and *Trichoptera*

**Table 2: Trace Metal Levels in Macro Invertebrates and Fish in Stormwater Ponds**  
(All values mg/kg dry weight unless otherwise indicated)

Organism	N	Cadmium	Copper	Lead	Zinc
Snails <sup>1</sup>	18	NA	44.4	1.56	73.14
Damselflies <sup>1</sup>	18	NA	23.55	3.25	101.13 *
Composite <sup>1</sup>	18	3.4	30.53	0.49	169.58 *
Redear Sunfish <sup>2</sup>	7, wet	1.64 *	6.37 *	15.78 *	42.42 *
Largemouth Bass <sup>2</sup>	7, wet	3.16 *	3.81	12.04	29.99 *
Bluegill Sunfish <sup>2</sup>	7, wet	0.006	2.08 *	0.70	36.61

Sources: <sup>1</sup> Karouna-Renier, 1996      <sup>2</sup> Campbell, 1995 (whole fish samples)

Note: An asterisk indicates that the stormwater sample was significantly higher than the control site at the 95% confidence interval.

largemouth bass (*Micropertus salmoides*), and the omnivorous bluegill sunfish (*Lepomis macrochirus*). The metal level in the tissue of 15 fish of each species were sampled from stormwater ponds, and compared to an equal number of fish caught at unpolluted control sites. As might be expected, Campbell found that the redear sunfish, which feeds off macro-invertebrates located in pond sediments, had the greatest accumulation of metals in its tissues (Table 2). The predaceous largemouth bass had moderate metal accumulation, while the omnivorous bluegill had lower metal levels. In most cases, however, metal levels in the three fish species sampled in stormwater ponds were significantly higher than control sites, often by a factor of five to 10. The degree of bio-accumulation was influenced, but not directly related to, the metal levels found in the bottom sediments.

The studies imply that trace metals in trapped pond sediments can and do move into the pond food web, probably starting with the macro-invertebrates that live and feed among pond sediments. Bottom-feeding fish that consume these macro-invertebrates appear to take up metals, which in turn may move further along the food web into the predatory fish that consume them. It was not clear, however, whether the metal levels were high enough to exert toxic effects. Preliminary evidence suggests that metal levels were *not* great enough to exert acute toxic effects in the aquatic community of stormwater ponds. Though it should be stressed that pond sediment metal levels in the study ponds were well below the mean levels observed in a national survey of stormwater ponds (see Table 3, and article 80).

Clearly, more research is needed to determine if greater metal uptake occurs in other stormwater pond food webs before an unequivocal conclusion can be reached. At the present time, it seems prudent to restrict human consumption of fish from stormwater ponds until a larger sample size has been tested. Research needs to be gathered on bioaccumulation in rough fish (such as carp) that are vegetarian or scavengers. More research is also needed to examine if metals are bio-accumulating in wading birds, such as herons and egrets, that feed on all three trophic levels.

—TRS

#### References

- Campbell, K.R. 1995. "Concentrations of Heavy Metals Associated with Urban Runoff in Fish Living in Stormwater Ponds." *Archives of Environmental Contamination and Toxicology* 27: 352-356.
- Galli, F. J. 1988. *A Limnological Study of an Urban Stormwater Management Pond and Stream Ecosystem*. M.S. thesis. George Mason Univ. Fairfax, VA.
- Karouna-Renier, N. 1995. *An Assessment of Contaminant Toxicity to Aquatic Macro-Invertebrates in Urban Stormwater Treatment Ponds*. M.S. Thesis. University of Maryland. College Park, MD.
- Yousef, Y., Lin, J. Sloat and K. Kaye. 1991. *Maintenance Guidelines for Accumulated Sediments in Relation/Detention Ponds Receiving Highway Runoff*. Univ. Central Florida, FL Dept of Transportation. 210pp.

**Table 3: Comparison of Trace Metal Levels in Stormwater and Sediments**  
(All values mg/kg dry weight unless otherwise indicated)

Investigators	N	Cadmium	Copper	Lead	Zinc
Karouna-Renier	18	0.26	8.6	10.92	28.03
Campbell	7 (wet)	0.28	14.11	4.91	28.82
National (article 80)	36	5.24	18.0	111	97.8



## Article 84

Technical Note #89 from *Watershed Protection Techniques*, 2(3): 453-454

# Human and Amphibian Preferences for Dry and Wet Stormwater Pond Habitat

**W**hat kind of ponds make the best habitat for homeowners and frogs? Some answers to this question have emerged from two surveys. Resident attitudes toward stormwater ponds in the Champaign-Urbana area were recently sampled by Emmerling-DiNovo (1995). The study area, located in east central Illinois, included seven residential subdivisions that employed two different stormwater management strategies—large wet ponds and dry detention basins. The ponds were large, ranging from two to 12 acres in size. Most of the wet ponds had rectangular shapes and had little shoreline vegetation. Similarly, the dry detention basins were flat and rectangular and had a mown grass cover. All ponds had common access and were maintained by a homeowner's association. The flat and level landscape of the study area had few water features.

Emmerling-Dinovo surveyed over 140 homeowners in the affluent subdivisions (mean annual income of \$90,000). The respondents all owned single family homes, and had lived in them for an average of eight years. The survey was structured to compare the attitudes of homeowners toward wet and dry ponds and queried not only residents who live adjacent to ponds, but also those that do not. In addition, the survey asked homeowners to rank the value of ponds relative to other amenities in the subdivision. Survey results indicate that residents clearly preferred wet ponds over dry ponds. For example, slightly over 82% of all respondents were willing to pay a premium to live next to a wet pond. By contrast, 67% percent of residents were unwilling to pay any premium to live next to a dry pond, and 10% felt that such a lot should be discounted.

Residents were asked to estimate the value of lots adjacent to and distant from both wet ponds and dry ponds. Results are portrayed in Table 1. On average, wet ponds were perceived to add four to 24% to the value of an adjacent lot. In contrast, dry ponds were felt to subtract from three to 10% from the value of an adjacent lot. The wet pond premium is consistent with that reported in article 81 for 20 stormwater wet ponds and wetlands in other regions of the country. It is also comparable to the results of a similar homeowner survey of two residential subdivisions in Ontario, Canada. Baxter *et al.* (1985) found that 17% of residents who were distant from wet pond but living within the same subdivision would be willing to pay a premium to live next to one; and, nearly half of all residents who lived next to one felt it enhanced their property value.

The survey revealed an interesting sociological phenomenon—the existence of “wet” people and “dry” people. “Wet” people, who live in subdivisions with wet ponds, exhibit the strongest preferences for living next to wet ponds, and express the greatest disdain for dry ponds. When asked what they liked most about their neighborhood, 63% of “wet” people identified the wet pond. On the other hand, “dry” people, who live in subdivisions with dry ponds, did not exhibit very strong preferences for either wet ponds or dry ponds. In addition, “dry” people did not value natural areas, wildlife and recreation as highly as “wet” people.

The attractiveness and image of the subdivision, along with potential resale value, were the three primary factors considered in purchasing a home according to the survey. If these factors were held constant, however, the presence of a wet pond was very important in individual lot selection. For example, over half of

Table 1: Pond Premium or (Discount) for Lots Adjacent to, or Distant from Wet and Dry Stormwater Ponds (Emmerling-Dinovo, 1995)

Location of Survey Respondent	Wet Pond Premium	Dry Pond Discount
Next to Wet Pond	23.9%	(-9.9%)
Distant from Wet Pond	13.4%	(-10.2)
Next to Dry Pond	7.8	(-2.5)
Distant from Dry Pond	4.4	(-8.9)



the respondents indicated that the presence of a pond had a strong or very strong influence on their selection of a lot. In fact, wet ponds outranked five other common subdivision features—natural areas, cul-de-sacs, golf courses, public parks, and the unloved dry pond. (see Table 2). What is perhaps the most striking about the Emmerling-DiNovo survey is that the poorly landscaped and geometrically simple wet ponds scored so highly. How much more value might they have had if they were designed with more natural shapes and better landscaping?

Amphibians such as frogs, toads and spring peepers, also exhibit similar preferences for living next to wet ponds compared to dry ponds, according to a survey by Bascietto and Adams (1983). These wildlife researchers conducted an evening call count of frogs and toads at 14 stormwater ponds in Columbia, Maryland. The ponds were divided into three categories: wet ponds, dry ponds, and dry ponds with streams (Table 3). As might be expected, dry ponds without streams were very poor amphibian habitat, with only one species recorded in the call survey (the American toad). On the other hand, wet ponds and the dry ponds with streams were much better habitat with five species frequently recorded. Wet ponds were favored by more true frogs, whereas toads and tree frogs preferred dry ponds with streams. The greatest amphibian diversity occurred when ponds had shallow pools, gentle slopes, dense emergent vegetation, and adjacent forest habitats.

The clear implication is that wet ponds are a better habitat than dry ponds and provide an important link to increased diversity. A designer that makes a wet pond more attractive to both amphibians and humans can expect to increase the marketability of his or her subdivision.

—TRS

**Table 2: Comparative Ranking of Preference to Locate Adjacent to Six Common Subdivision Features in Illinois Residential Subdivisions (Emmerling-DiNovo, 1995)**

Locational Factor	Mean Score
Adjacent to wet pond	4.44
Adjacent to natural area	4.27
On a cul-de-sac	3.83
Adjacent to a golf course	3.67
Adjacent to public park	3.10
Adjacent to dry pond	2.05

Respondents were asked to rank each factor from 0 to 5, with five being the most preferred.

**References**

Bascietto, J., and L. Adams. 1983. "Frogs and Toads of Stormwater Management Basins in Columbia, MD." *Bulletin of MD Herpetological Society* 19(2): 58-60.

Baxter, E., G. Mulamootil and D. Gregor. 1985. "A Study of Residential Stormwater Impoundments; Perceptions and Implications." *Water Resources Bulletin* 21(1):83-88.

Emmerling-Dinovo, C. 1995. "Stormwater Detention Basins and Residential Locational Decisions." *Water Resources Bulletin* 31(3): 515-521.

**Table 3: Amphibian Species in Stormwater Ponds Frequency of Occurrence During an Evening Visit (Bascietto and Adams, 1983)**

Amphibian Species	Wet Pond	Dry Pond with stream	Dry Pond without stream
American toad	0.23	0.20	0.28
Fowler's toad	0.0	0.12	0.0
Grey Tree frog	0.23	0.45	0.0
Bull frog	0.13	0.0	0.0
Green frog	0.62	0.40	0.0

Frequency of occurrence at each site during individual evening call surveys at 14 stormwater ponds (N= 4 to 5 of each type shown). Spring peepers were also noted in earlier surveys of wet ponds and dry ponds (that had flowing water).



R0079918

# Dragonfly Naiads as an Indicator of Pond Water Quality

by John Trevino, Lower Colorado River Authority

The whirl of a dragonfly is a common sound along the edge of freshwater ponds. The adult dragonfly, however, begins its life cycle within the pond. The juvenile stage, known as a naiad, burrows in the mud or lurks within the shoreline vegetation (see Figure 1). Despite their small size, dragonfly naiads are voracious predators, feeding on other aquatic macroinvertebrates and even larger prey items. Given their position in the pond food web, dragonfly naiads could be a useful indicator of pond water quality. A simple way to test their value as an environmental indicator is to compare dragonfly naiads found in undisturbed freshwater ponds with those that inhabit the more stressful conditions of stormwater ponds.

The Lower Colorado River Authority (LCRA) recently examined this issue as part of an intensive biological study of a recently constructed stormwater pond. Wet ponds are generally considered experimental in the semi-arid climate of Central Texas because high evaporation rates often require ponds be augmented with water in order to maintain a permanent pool and sustain an aquatic ecosystem.

## Indicators for Lentic Systems

The stormwater pond was built in Travis County, Texas, on LCRA property known as the Mansfield Tract. The wet pond captured runoff from a newly constructed bridge over Lake Austin and a roadway. Constructed in a natural depression in the floodplain of the Colorado River adjacent to Lake Austin, the pond was augmented by Lake Austin water. The soils surrounding the wet pond contained alluvial silt and clay. The pond had a drainage area of approximately 9.5 acres, and was 150 feet long, 90 feet wide and five feet deep. The structure was designed with a permanent pool of approximately 0.4 watershed inches.

Since most macroinvertebrates are habitat specific, scientists planted local emergent and submergent vegetation within the wet pond to provide habitat structure. The vegetation was planted around shallow peripheral areas of the pond. Miller *et al.* (1989), Engel (1985) and Dvorak and Best (1982) have shown that aquatic macrophytes are heavily colonized by macroinvertebrates. Among the submergent vegetation planted were two obligate wetland plant species predicted to do well in these types of systems, *Elodea canadensis* (waterweed) and *Myriophyllum spicatum* (eurasian watermilfoil). A third obligate wetland macrophyte, *Najas guadalupensis* (southern naiad) established itself unexpectedly in the middle of the study. All three species are adapted to the low flow velocity and low turbulence associated with lentic areas. Emergent vegetation was also planted, including *Phragmites australis* (common reed), *Scirpus validus* (soft-stem bulrush) and *Sagittaria latifolia* (arrowhead).

Researchers conducted five macroinvertebrate surveys of the wet pond vegetation between November 1994 and July 1996. Organisms were collected qualitatively with a standard 500 micron mesh dipnet. Four one-meter "drags" were made through submerged vegetation with the dipnet for one minute. Samples were preserved in the field and later sorted, enumerated, and identified to the lowest possible level using taxonomic keys by Merritt and Cummins (1996).

In lotic (running waters) systems, macroinvertebrates have been widely used as reliable water quality indicators (Shackleford, 1988; Plafkin *et al.*, 1989). This is not true for lentic systems (ponds and lakes). Indicators for lentic systems such as wet ponds are still under development. In the absence of such indicators, scien-

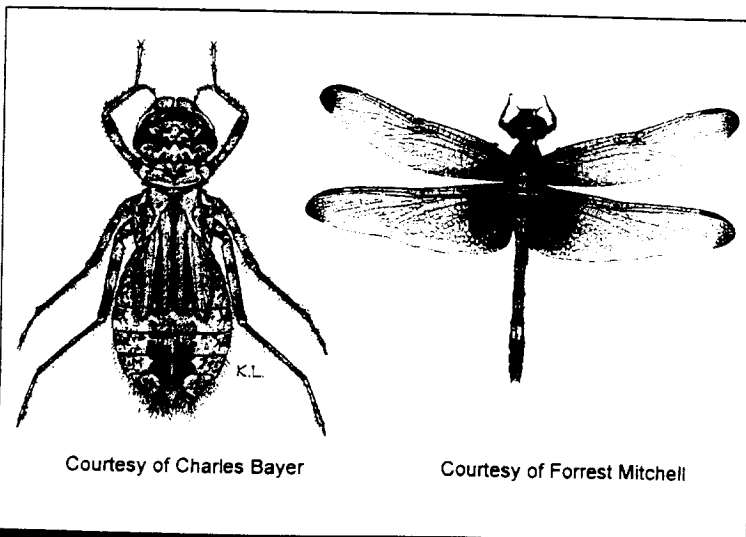

Figure 1: Dragonfly Naiad and Adult (*Dythemis* species)

tists frequently adopt metrics developed for flowing systems on lentic environments (Karouna-Reiner, 1995). This approach may provide a meaningful synopsis of the ecological condition of a wet pond, but it is still viewed as controversial.

Stormwater runoff quality entering the wet pond was also characterized during 21 storm events, although due to drought, only three pond outflows were recorded. Average TSS concentrations to the pond were 125 mg/l, which are comparable to other sediment monitoring data in the Austin area for developed areas (LCRA 1991). Baseflow TSS concentrations in the wet pond were 23 mg/l, which again were comparable to a study of other wet ponds sampled in the same region (Mitchell *et al.*, 1995). Impacts of suspended and deposited sediment to the aquatic environment are well documented. Deposited sediment can impact the benthic macroinvertebrate community by causing physical smothering. Suspended sediment impacts the epiphytic macroinvertebrate community by limiting light penetration to macrophytes and reducing habitat.

Research on stormwater wet pond insect assemblages in semi-arid climates is limited at best. Indicator organisms for lentic systems are also lacking. Because of this dilemma, Mitchell and his colleagues (1995), proposed using dragonfly naiads as possible indicators of lentic system water quality. In preliminary studies, Mitchell showed that some dragonfly naiads, like *Tramea* sp., *Celithemis* sp. and *Dythemis* sp., may prefer cleaner-water ponds.

Table 1 compares the dragonfly naiad species collected from the LCRA wet pond study to a pair of stormwater ponds and an unimpacted freshwater reference ponds previously sampled by Mitchell *et al.* (1995). All data were collected during the fall of 1994 and 1995 using comparable methods. The table summarizes the presence and absence of the three dragonfly naiads species that are thought to be clean water indicators.

*Celithemis* sp., *Dythemis* sp., and *Tramea* sp. were either absent or present in very low numbers in stormwater wet ponds, including the Hwy. 620 wet pond. These genera were also absent or nearly absent in the other three surveys at the LCRA pond. In contrast, the three dragonfly naiad species were numerous in unimpacted reference ponds. This suggests that *Celithemis*, *Dythemis*, and *Tramea* species could be possible indicator organisms for pond water quality.

The initial trend seen in the dragonfly surveys was thought to be due to the input of pollutants from stormwater runoff. Other factors, however, could have produced this trend, such as seasonal change, early pond succession, continual augmentation by lake water and water level fluctuations. Because of the short term nature of the study (19 months), it was not possible to isolate the factor or factors that caused the disappearance of the dragonfly naiad species. To confirm study findings, additional research with long-term monitoring is recommended.

**Table 1: Comparison of Dragonfly Genera in Impacted and Unimpacted Wet Ponds**

Collection Period	Dragonfly Genera	Hwy. 620 Wet Pond	Mitchell Wet Ponds average	Mitchell Ponds average
<b>No. of individuals collected</b>		Impacted <sup>a</sup>	Impacted <sup>b</sup>	(Unimpacted) <sup>b</sup>
Oct-Nov 1994	<i>Celithemis</i> sp.	0	0	45
	<i>Dythemis</i> sp.	1	0	38
	<i>Tramea</i> sp.	2	0	9
Oct-Dec 1995	<i>Celithemis</i> sp.	0	0	19
	<i>Dythemis</i> sp.	0	0	19
	<i>Tramea</i> sp.	0	0	31

<sup>a</sup> Collection method: Four one-meter D-net drags through submerged vegetation. Duration of each drag equaled one minute. Wet pond is perennial, augmented by Lake Austin water. LCRA wet pond receives mostly highway and bridge runoff (Saunders and Gilroy 1997).

<sup>b</sup> Collection method: Five two-meter D-net drags through submerged vegetation and other pond material. All wet ponds are perennial. The two impacted wet ponds, Mule Pasture and Upper Wetlands, receive agricultural runoff; whereas the unimpacted reference ponds, Hort and Peanut Irrigation, are augmented by well water (Mitchell *et al.* 1995, Lasswell *et al.* 1997).



In summary, this study reinforced Mitchell's finding that some dragonfly naiads may be potential indicator organisms for lentic systems. Because little research has been done on lentic system indicators to date, this research provides an encouraging start for scientists attempting to identify cost-effective biological indicators to measure water quality impacts in ponds and lakes. Determining if *Celithemis* sp., *Dythemis* sp., and *Tramea* sp. are possible indicator organisms for storm-water wet ponds warrants further investigation.

#### References

- Dvorak, J. and E.P.H. Best. 1982. "Macroinvertebrate Communities Associated with the Macrophytes of Lake Vechten: Structural and Functional Relationships." *Hydrobiologia* 95:115-126.
- Engel, S. 1985. *Aquatic Community Interactions of Submerged Macrophytes*. Technical Bulletin No. 156. Department of Natural Resources, Madison, WI. 79 pp.
- Karouna-Reiner, N. 1995. *An Assessment of Contaminant Toxicity to Aquatic Macroinvertebrates in Urban Stormwater Treatment Ponds*. M.S. Thesis. University of Maryland. College Park, MD. 161 pp.
- Lasswell, James L. and Forrest L. Mitchell. 1997. *Survey of Dragonflies (Odonata: Anisoptera) in Central Texas Ponds*. Masters Thesis In Press. Journal of the Kansas Entomological Society, KS. 24 pp.
- Merrit, R. W. and K. W. Cummins. eds. 1996. *An Introduction to the Aquatic Insects of North America*. Third edition. Kendall/Hunt Publishing Co. Dubuque, IA. 862 pp.
- Miller, Andrew C., David C. Beckett, Carl M. Way, and Edmond J. Bacon. 1989. *The Habitat Value of Aquatic Macrophytes for Macroinvertebrates*. Report No. A-89-3. US Army Corps of Engineer, Department of the Army, Washington, D.C. 66 pp.
- Mitchell, Forrest L., James L. Lasswell, Ann L. Kenimer, Larry M. Hauck, and Kenya K. Kresta. 1995. *Biology of Dragonfly Naiads in Relation to Habitat and Water Quality*. 24th Water for Texas Conference. Austin, TX. 8 pp.
- Plafkin, James L., Michael T. Barbour, Kimberly D. Porter, Sharon K. Gross, and Robert M. Hughes. 1989. *Rapid Bioassessment Protocols for Use in Streams and Rivers*. Office of Water. EPA 440-4-89-001. Washington, D.C. 190 pp.
- Saunders, Geoffrey P. and Mary P. Gilroy. 1997. *Treatment of Nonpoint Source Pollution with Wetland/Aquatic Ecosystem Best Management Practices*. Final Report. Lower Colorado River Authority, Austin, TX. 182 pp.
- Shackelford, B. 1988. *Rapid Bioassessments of Lotic Macroinvertebrate Communities: Biocriteria Development*. Arkansas Department of Pollution Control and Ecology, Little Rock, AR. 45 pp.

## Article 86

Technical Note #12 from *Watershed Protection Techniques*, 1(1): 27

# Establishing Wildflower Meadows in New Jersey Detention Basins

The vegetative management of existing stormwater detention basins generally falls into one of two categories. Either they are intensively manicured as turf, or they become overgrown with weeds and non-native grasses and ultimately evolve into shrubs or forest. The first management strategy is costly, as it requires frequent mowing and chemical applications to maintain the manicured appearance often desired by adjacent residents. The second vegetation management strategy can be characterized as nothing more than *benign neglect*.

A third vegetation management approach has recently been promoted by Brash *et al.* (1992). They advocate the establishment of wildflower meadows in dry detention ponds, to create a more attractive appearance without the need for frequent mowing. Ten detention basins were planted in 1991 and various establishment techniques subsequently evaluated. The meadows were established with both annual and perennial wildflowers at relatively low cost (from 1/2 to one cent more per square foot compared to conventional hydroseeding of fescue with topsoil amendments).

Soils in most detention ponds are poor, so up to five inches of topsoil was initially added. A nurse crop of Sheep Fescue was established, seeded at a rate of 20 lbs/acre along with conventional seeding or hydroseeding of commercial wildflower mixes at about 10 to 12 lbs/acre. "Clean" straw mulch (i.e., relatively weed-free wheat or barley straw) was applied at 1,000 to 1,500/lbs/acre for initial erosion control and weed suppression.

First year establishment of a wildflower meadow was attained at most sites, as determined by visual surveys. Poor establishment was observed in detention ponds that were subject to frequent inundation (i.e., experiencing more than 48 hours of inundation five or more times during the growing season). This finding suggests that wildflower meadows will be hard to establish in extended detention ponds. Wet seed mixes are available for these wet areas, but they are more costly.

Fertilization did not have a positive effect on wildflower establishment, and may have actually benefited competing weeds and grasses. Annual mowing is required, either in the fall (for maximum seed dispersal) or in the late winter (for maximum winter wildlife cover). Ideally, mowing equipment should be used that cuts at

four inches high, but this equipment is seldom commercially available. Overseeding of annual wildflowers in the spring or perennial wildflowers in the fall is needed to maintain diversity in the meadows over time. Experience has shown that perennial wildflower meadows will become dominated by a few species in three or four years if they are not annually overseeded (Brash, pers. comm.).

Best results were obtained when the meadow was established soon after the construction of the pond. To prevent erosion during pond construction, it may be advisable to use oats or sheep fescue to achieve rapid, temporary vegetative cover during construction (avoiding the more aggressive tall fescues mixtures that are commonly used for this purpose).

For existing detention ponds, it may be necessary to use Roundup® or other herbicides to kill the aggressive grasses and permit the development of the slower-growing wildflower species. A more expensive but non-chemical approach, would be to scrape the top three inches of soil, and replace it with topsoil.

The wildflower meadow approach appears to be an attractive vegetation management option for the drier portions of many stormwater ponds, as long as annual mowing and overseeding are performed.

—TRS

### Reference

- Brash, W., C. Halbower, A. Hryncyszyn and L. Ennis. 1992. *Establishment of Wildflower Cover in Stormwater Basins*. Prepared by Mercer County Soil Conservation District. Hamilton Square, N.J. 27 pp.

88

R0079922

# Persistence of Wetland Plantings Along the Aquatic Bench of Stormwater Ponds

**S**henot (1993) evaluated the persistence of wetland plantings along the aquatic bench of three stormwater ponds two to three years after they were initially planted. Each pond had been planted with six to eight species of wetland plants in single-species clusters at an average density of four plants/square meter. Two of the three ponds were extended detention ponds. In those ponds, the aquatic bench was subject to periodic inundation by as much as three to six feet of runoff, as well as incidental loading of trash and debris.

Shenot reported that 82% of the planted species persisted in the ponds after two to three years. However, the persistence of planted species within individual planting clusters was somewhat lower (68%). As indicated in Table 1, several wetland species showed

both persistence and a significant rate of spread (pickerelweed, arrowhead, softstem bulrush, and common three-square). Other species showed good persistence but a low rate of spread across the bench (sweet flag and wild rice). In particular, wild rice achieved high local densities (433/m<sup>2</sup>) and was extensively utilized by wildlife.

Other species (arrow arum and lizard's tail) did not survive in most planting cells. The persistence of planted species appeared to be inversely related to the frequency and depth of inundation caused by extended detention. Other factors thought to contribute to poor survivorship were poor inorganic soils, steep bench slope, and predation by ducks.

Shenot also enumerated the 35 to 80 wetland plant species that became established as volunteers within the wetland planting clusters. Although exotic grasses, smartweed, and cattails were present, many of the most numerically abundant species were rushes, sedges, and other native wetland plants (Table 2).

It should be noted that the three most successful planted species (pickerelweed, soft stem bulrush and wild rice) were seldom dominant wetland plants within their original planting zone. And despite some spread, they were still a negligible component of the entire wetland plant community after three years. Competition from volunteer species and preferential waterfowl grazing may explain this pattern.

Cattails, which are notorious for invading and dominating shallow water, had established themselves in 50% of the planting clusters, but were present in relatively low densities (three plants per square meter). Shenot concluded that planting clusters were a useful method to improve the quality and diversity of the aquatic bench, both for existing ponds and newly-constructed ponds. Longer-term monitoring will be needed, however, to determine the ultimate trajectory and composition of the planted wetland community along the aquatic bench of stormwater ponds.

—TRS

## Reference

Shenot, J. 1993. *An Analysis of Wetland Planting Success at Three Stormwater Management Ponds in Montgomery Co., MD.* M.S. Thesis. Univ. of Maryland. 114 pp.

**Table 1: Relative Persistence of Eight Species of Wetland Plants on the Aquatic Bench (Shenot, 1993)**

	Persistence	Spread
Sweetflag ( <i>Acorus calamus</i> )	Good	Limited
Arrow arum ( <i>Peltandria virginia</i> )	Poor	None
Pickerelweed ( <i>Pontederia cordata</i> )	Good	Moderate
Arrowhead ( <i>Sagittaria latifolia</i> )	Excellent	Excellent
Lizard's tail ( <i>Saururus cernuus</i> )	Poor	None
Common three square ( <i>Scirpus americanus</i> )	Good	Excellent
Soft stem bulrush ( <i>Scirpus validus</i> )	Excellent	Good
Wild rice ( <i>Zizania aquatica</i> )	Excellent	Limited

**Table 2: Top 10 Volunteer Species Recorded at the Three Ponds (Shenot, 1993)**

1. Various exotic grasses ( <i>Gramineae</i> )	75%
2. Soft rush ( <i>Juncus effusus</i> )	55%
3. Fox sedge ( <i>Carex vulpinoidea</i> )	33%
4. Other sedges ( <i>Carex sp.</i> )	33%
5. Smartweeds ( <i>Polygonum sp.</i> )	33%
6. Most many-flowered aster ( <i>Aster spp.</i> )	30%
7. False nettle ( <i>Boehmeria cylindrica</i> )	30%
8. Rice cutgrass ( <i>Leersia oryzoides</i> )	30%
9. Va. bugleweed ( <i>Lycopus virginicus</i> )	30%
10. Spike rush ( <i>Eleocharis spp.</i> )	22%

Defined as percentage of stations where the species was recorded as one of the five most numerically dominant species at the station. N = 40.

# Wetlands

R0079924





# Article 88

Technical Note #102 from *Watershed Protection Techniques*, 3(1): 597-600

## Return to Lake McCarrons

*Does the performance of wetlands hold up over time?*

**H**ow well does the pollutant removal performance of ponds and wetlands hold up over time? Some have speculated that it must decline, while others assume that it remains constant. Until recently, however, there has been no monitoring data to answer the question. Almost all pond and wetland monitoring studies have been one-time "snapshots" taken over a few years at most, and usually right after construction. Thus, any assumption about the future performance of a stormwater pond or wetland is simply an assumption. A recent study by Gary Oberts (1997) and his colleagues, however, sheds more light on what we can expect about the long term performance of stormwater ponds and wetlands.

Oberts returned to a Minnesota pond/wetland system that he had first investigated nearly a dozen years before. The Lake McCarrons system consists of two main stormwater treatment areas: a wet pond with a surface area of about 2.5 acres, and a six-acre linear wetland composed of five cells (Figure 1). The entire system provided about 0.32 inches of treatment storage, with about 40% allocated to the pond and 60% to the wetland cells. The treatment system had a large contributing drainage area (736 acres) which was 27% impervious. The predominant land use was single family residential homes, interspersed with some commercial development and highways.

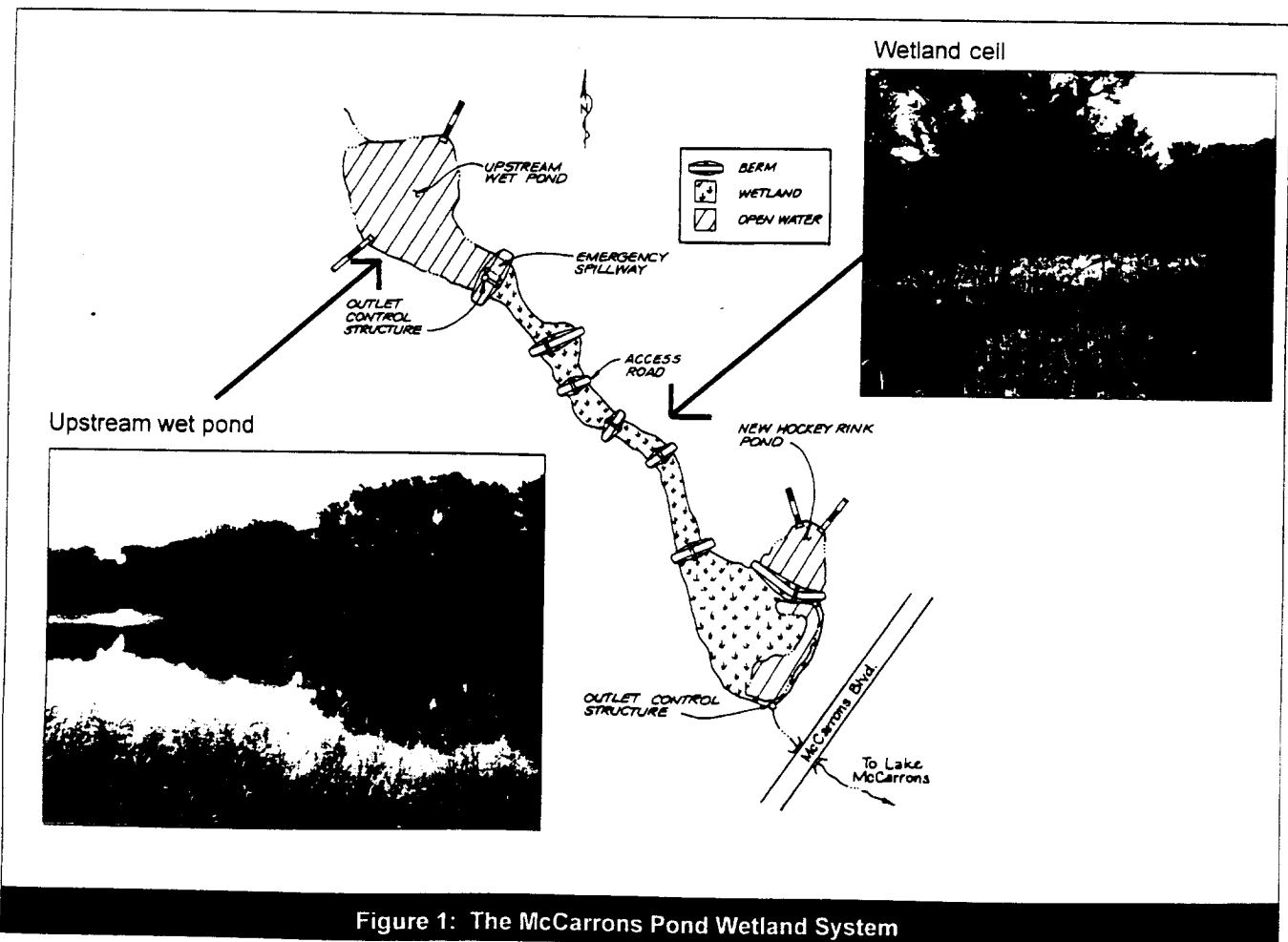

Figure 1: The McCarrons Pond Wetland System



Located near the twin cities of Minneapolis and St. Paul, the McCarrons system experiences cold and snowy winter conditions. While annual precipitation is modest (about 26 inches rainfall equivalent), much of it occurs as snow—about 50 inches each year. Cold winter temperatures present a major performance challenge for the system. A two foot thick layer of ice usually forms over the pond every winter, and ice also covers the wetland cells. The melt of the watershed snowpack creates a major runoff event in the spring, at a time when much of the system is still frozen and outlet structures are obstructed by ice.

Runoff and snowmelt events dominate the water balance at the McCarrons system (72% of total flow). Baseflow, which averages about 0.3 cfs, comprises the remainder of the total annual flow. About 10% of the total flow was lost as it traveled through the system, presumably due to evaporation and infiltration.

The McCarrons system was constructed in 1985 and its performance was intensively sampled over the next two years (Oberts and Osgood, 1988). The original monitoring effort consisted of automated sampling of 21 rainfall and four snowmelt events, as well as four baseflow samples. The pond system exhibited remarkably high pollutant removal over this period, particularly given that the winter conditions and the loss of 18 percent of the pond capacity due to sediment deposition from upstream construction (Table 1). The reduction in sediment, phosphorus and nitrogen mass was 96, 70 and 58%, respectively. In each case, the removal of the McCarrons system was about 15 to 20% higher than the national average performance for pond and wetland systems (see article 64).

Nutrient removal was slightly greater in the pond than in the wetland cells, and during summer months as

compared to the winter months. The very high phosphorus removal (70%) was believed to be due in part to the sapric peat subsoils that were exposed during the excavation of the system. These subsoils contained high amounts of peat and organic matter which may have been important binding sites for phosphorus, at least until the soils were either saturated or buried.

Ten years later, Oberts and his colleagues returned to Lake McCarrons, and sampled 35 storm and snowmelt events over a 22-month period, as well as quarterly baseflow quality samples. He employed essentially the same sampling effort and monitoring methods as were used in the first study, and therefore could compare how pollutant removal rates had changed over time.

The pond/wetland system and its catchment had changed in several ways in the 10 years since the first monitoring study. In particular, about 100 acres of new drainage area was connected to the system which fed into the system downstream of the headwater detention pond. Another small inlet pipe was directly connected to the last wetland cell in the system, which resulted in short-circuiting of this runoff through the system. In addition, several berms that formed the individual wetland cells had eroded, and flow across the entire wetland had begun to channelize. On the plus side, the main pond cell had been dredged to its original dimensions shortly before the second round of monitoring began (at a cost of \$50,000).

The wetland community has also changed significantly over the years. Wetland species that had been originally planted in the cells were largely supplanted by invasive species, such as cattail, reed canary grass, purple loosestrife and duckweed. A recent wetland plant inventory indicated that 17 plant species were now colonizing the emergent zone, half of which were invasive species. Relict populations of bulrush, water lilies and water irises that were part of the original wetland planting plan could still be found in a few places. The characteristics of the wetland sediments had also changed substantially in the intervening years. Both iron and aluminum concentrations in pond and wetland sediments had declined sharply since 1985, indicating that the bottom sediments had lost much of their capacity to adsorb phosphorus.

Oberts found that the performance of the McCarrons system had clearly declined during the second monitoring study. The mass reduction of sediment, phosphorus and nitrogen dropped to 66, four and 33%, respectively (Table 1). Most of the pollutant removal occurred in the pond rather than the wetland, with the exception of nitrogen. Pollutant removal during storm events at McCarrons was generally within the range of pollutant removal for other pond and wetland systems (Table 2). Removal during snowmelt events was slightly lower. Pollutant removal was greatest during the onset of snowmelt, but declined sharply and even became negative during the later stages of the melt.

**Table 1: Total Mass Removal Efficiency of the McCarrons Pond/Wetland System (Storm and Base Flow)**

Parameter	1985 - 1986 Study (%)	1995-1996 Study (%)
Total suspended solids	96	66
Volatile suspended solids	95	56
Total phosphorus	70	4
Dissolved phosphorus	45	23
Chemical oxygen demand	80	32
TKN	55	19
Nitrate	63	68
Total nitrogen	58	33
Lead	93.2	not measured
Zinc	not measured	38

The primary factor causing the decline in pollutant removal rates from 1985 to 1995 was the fact that the system became "leakier" in between storm events. This behavior is best exemplified by the export of total phosphorus under baseflow conditions (Figure 2). In 1985, total phosphorus removal was consistently high during storms but was essentially zero during baseflow conditions. While storm removal remained fairly high during the 1995 study, a substantial mass of total phosphorus was exported during baseflow conditions (total phosphorus removal was an astounding negative 344%). The baseflow total phosphorus concentration out of the system doubled from 1985 to 1995, and was actually higher than the average concentration leaving the system during storms (Table 3).

Oberts also measured the delta-T or change in stormwater and baseflow temperature as it flowed through the system. He found that the system increased the average flow temperature by nine degrees Fahrenheit during the productive summer months. Interestingly, the warm discharge from the system had a strong influence on the limnology of Lake McCarrons. The warmer stormwater flows did not mix through the water column, but instead remained in the epilimnion, or upper part of the lake. Since the stormwater phosphorus concentrations were high, this led to higher algal growth in the lake than would have otherwise occurred.

**Table 2: Comparison of Pollutant Removal During Rainfall and Snowmelt Events, Lake McCarrons 1995-1996**

Parameter	Storm event removal (%)	Snowmelt event removal (%)
Total suspended solids	78	76
Total phosphorus	38	35
Dissolved phosphorus	52	36
Chemical oxygen demand	48	42
TKN	39	26
Nitrate-N	60	48
Total nitrogen	42	29

Another stormwater practice that has been sampled at two separate points in time was located in a much warmer climate—a Florida pond/wetland system originally monitored by Martin and Smoot (1986) and subsequently monitored about seven years later by Gain (1996). This retrospective study also concluded that sediment and nutrient removal declined sharply as the system aged, and in many cases, became negative (Table 4). It should be noted that Gain's retrospective analysis was plagued by problems that make it hard to make an exact

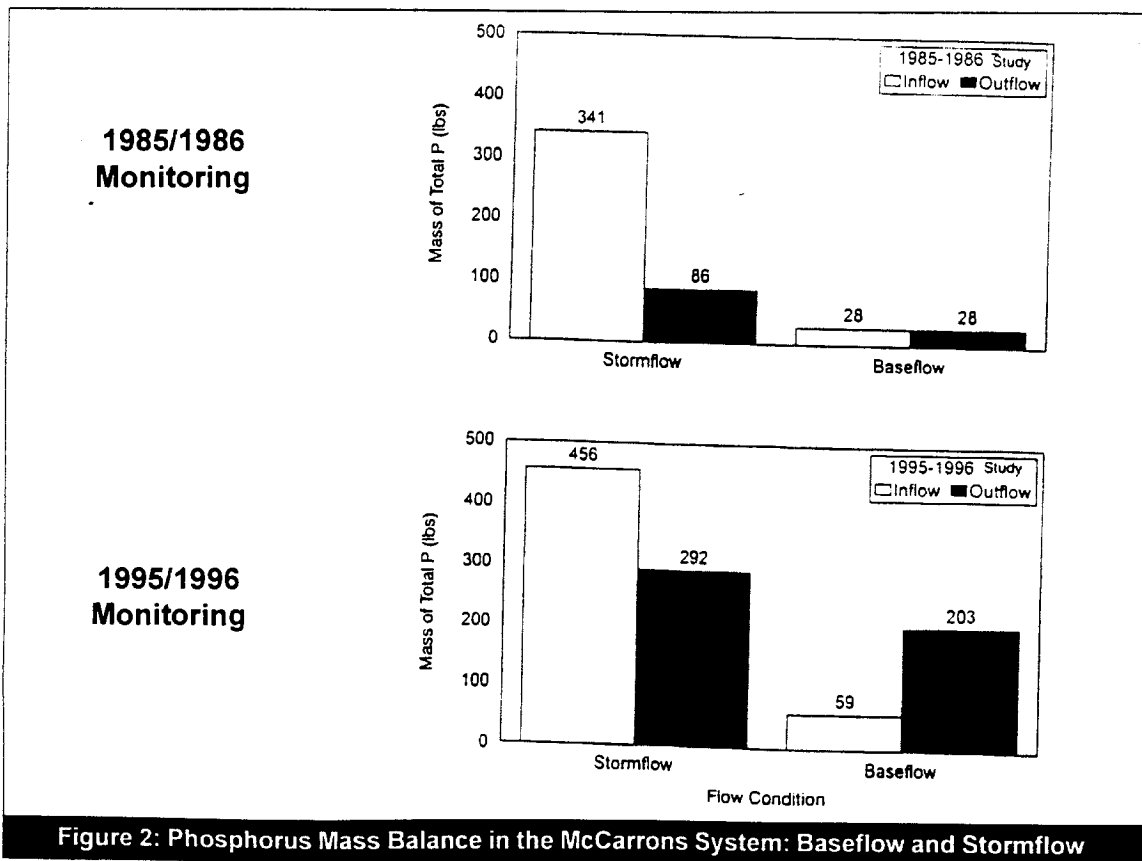

**Table 3: Mean Outflow Concentrations (mg/l) From the McCarrons Pond/Wetland System, 1995 and 1996**

Parameter	Stormflow	Baseflow
Total suspended solids	22.6	14.0 (10.0)
Total phosphorus	0.25	0.32 (0.16)
Dissolved phosphorus	0.13	0.08 (0.06)
TKN	1.42	1.47 (1.23)
Nitrate	0.27	0.21 (0.31)
Total nitrogen	1.64	1.68 (1.54)
Zinc	0.009	< 0.009

Note: Numbers in parentheses reflect baseflow means for the 1985-1986 monitoring study for comparison purposes

**Table 4: Comparison of Storm Pollutant Removal at a Florida Pond/ Wetland System Seven Years Apart (N=22) (Gain, 1996)**

Parameter	1982 - 1984 %	1989 - 1990 %
Total suspended solids	55	24
Total organic carbon	5	-31
Total phosphorus	22	-9
Dissolved phosphorus	34	5
Total nitrogen	15	-25
Total lead	74	23
Total zinc	39	45

comparison (e.g., the runoff coefficient increased over time, the pond had filled with at least a foot of sediment, incoming pollutant concentrations had declined and often were near the irreducible levels, and storm frequencies were different). Still, the performance trend at the Florida pond was clear. The modest reduction in nutrient loads was offset by a modest export from the wetland. Some evidence was found for internal nutrient recycling within both the pond and wetland.

**Summary**

The return to Lake McCarrons suggests that the pollutant removal performance of pond/wetlands may not hold up over time, especially for wetlands, and particularly for phosphorus. While the removal rates for the pond component also declined, the drop was not nearly as great as the wetland. Many more carefully

controlled retrospective studies are needed at other ponds and wetlands before this finding can be generalized. But in the meantime, prudent watershed managers should reevaluate their assumption that the long term pollutant removal of stormwater practices is constant, and possibly consider "discounting" removal rates when formulating watershed plans or TMDLs.

The study of the Lake McCarrons system is not over. In the next few years, the wetland will be extensively "repaired," possibly by reconfiguring the wetland berms, removal or burial of saturated soils, regrading of wetland swales to reduce channelization and installation of a new inlet structure from the pond to the wetland. Oberts plans a third monitoring effort to test whether the wetland repair will actually improve pollutant removal rates for the system.

—TRS

**References**

Gain, W.S. 1996. "The Effects of Flow Path Modification on Water Quality Constituent Retention in an Urban Stormwater Detention Pond and Wetland System. Orlando, FL." *US Geological Survey Water Resources Investigations Report 95-4297*. Tallahassee, FL .44 pp.

Martin, E. and J. Smoot. 1986. "Constituent Load Changes in Urban Stormwater Runoff Routed Through a Detention Pond/Wetlands System in Central Florida." *US Geological Survey Water Resources Investigations Report 85-4310*. 74 pp.

Oberts, G. 1997. *Lake McCarrons Wetland Treatment System -- Phase III Study Report*. Metropolitan Council Environmental Services. St. Paul, Minnesota

Oberts, G.L and R.A. Osgood. 1988. *Lake McCarrons Wetland Treatment System: Final Report on the Function of the Wetland Treatment System and the Impacts on Lake McCarrons*. Metropolitan Council Publication no. 590-88-095. St. Paul, MN.

# Nutrient Dynamics and Plant Diversity in Stormwater Wetlands

The performance of two stormwater wetland systems in the coastal plain of Maryland were monitored over a two year period by Athanas and Stevenson (1991). The wetland plant community was established by planting at one site (Queen Anne) and volunteer colonization at the second (Washington Business Park).

The 0.6 acre Queen Anne stormwater wetland treated runoff from a 16 acre catchment containing the roof, parking areas, and ballfields of a high school. About 30% of the wetland's surface area was in the 0 to -12 inch depth zone, with the remaining surface area in the -12 to -24 inch depth zone. A polyliner and six inch sand layer was placed on the bottom to prevent groundwater intrusion. The wetland was planted with 4,000 plants of three species (common three square, lizards tail, and duck potato (*Sagittaria*)) at an approximate density of 0.7 plants/square foot.

The Queen Anne stormwater wetland was reasonably effective in removing sediment, total phosphorus and total nitrogen from urban runoff (Table 1). Removable of soluble nutrient forms (ortho-P, ammonia and nitrate) were frequently above 50%, whereas removal of particulate forms was slightly negative. This pattern has been seen in many ponds and wetlands where both baseflow and stormflow performance monitoring is conducted. The current explanation is that soluble nutrient forms are taken up by algae and bacteria and are then incorporated into particulate forms. Due to intense biological activity in the wetland during the growing season there is a slight export of particulate nutrients in the outflow from the wetland.

The authors felt that overall removal rates could have been higher, but the sand substrate on the bottom of the wetland did not contain enough organic matter to provide the exchange sites to trap pollutants. The sand substrate was also impoverished with respect to aluminum and iron cations, which help to increase phosphorus binding to sediments. A review of the outflow concentrations from the wetland after the fall plant dieback did not reveal any pulse or spikes of dissolved nutrient concentrations.

The plant community in the Queen Anne stormwater wetland showed an interesting development pattern. While the planted species survived well, the emergent marsh zone was invaded by cattails and spike rush, along with other rushes, sedges (*Carex*), and boneset (*Eupatorium perfoliatum*). The cattail had spread to

most of the marsh after three years, but did not crowd out the other species. They formed a kind of structural matrix that many other species appear to exploit. The mean above-ground biomass in the stormwater wetland after two years was about 350 grams dry weight per square meter. The greatest unit biomass was recorded in saturated soils not inundated (above normal pool).

A series of monitoring problems prevented the computation of pollutant removal performance at the Washington Business Park "volunteer" stormwater wetland. Based on a comparison of inflow and outflow concentrations, it did appear to be an effective facility, despite much higher sediment and nutrient inputs. The plant community was dominated by cattails and common reeds (*Phragmites*). The sedges, rushes and other emergent species found at the Queen Anne site were poorly represented at the Washington Business Park. This presumably reflects the value of intentional planting and also perhaps greater sediment deposition.

—TRS

**Reference**

Athanas, C. and C. Stevenson. 1991. *The Use of Artificial Wetlands in Treating Stormwater Runoff*. Prepared for the Maryland Sediment and Stormwater Administration. 66 pp.

**Table 1: Pollutant Removal at the Queen Anne Stormwater Wetland Site**

Urban Pollutant	Percent Mass Reduced
Total Suspended Solids	65.0
Orthophosphorus	68.7
Total Dissolved Phosphorus	44.3
Total Organic Phosphorus	-5.7
Total Particulate Phosphorus	7.2
Total Phosphorus	39.1
Nitrate+Nitrite-Nitrogen	54.5
Ammonia-Nitrogen (NH <sub>4</sub> )	55.8
Total Organic Nitrogen	-5.4
Total Particulate Nitrogen	-5.0
Total Nitrogen	22.8

Mass reduced for both storm and baseflow events over 23 months



# Adequate Treatment Volume Critical in Virginia Stormwater Wetland

**T**he performance of a small stormwater wetland (0.3 acre) was assessed over a two year period in suburban Northern Virginia. The wetland was created within an existing stormwater detention basin that served a 40 acre residential and commercial watershed (30% impervious). The total treatment volume was not great, approximately 0.1 watershed-inch of storage.

The shallow wetland was planted with container-grown common three square, rice cutgrass, and arrowhead at a density of one plant per four square feet. Waterlily and spatterdock were planted in the deeper zones of the marsh as well. The performance of the wetland was characterized by continuous flow composite sampling of 23 storm events, as well as routine baseflow monitoring. In addition, the investigators examined the seasonal nutrient dynamics in the wetland's biomass.

The large input of stormwater from all storms appeared to overwhelm the capacity of the wetland to remove nutrients (Table 1). Removal was low or negative for most forms of phosphorus and nitrogen. The wetland also was a net exporter of zinc and aluminum. Removal of suspended solids was only moderate (62%).

The wetland performed much better during smaller storms (defined as storms generating runoff volumes smaller than the 0.1 watershed-inches of storage provided by the wetland). In fact, nutrient and sediment removal rates frequently exceeded 60 to 70%. This finding strongly suggests that stormwater wetlands

can be effective in removing pollutants from urban stormwater, but need to be sized appropriately to accommodate greater runoff volumes.

The seasonal baseflow monitoring provided several interesting insights about the nutrient dynamics of the wetland. First, no dramatic increase in soluble nutrients was experienced at the end of the growing season when the plants die back. A number of researchers have predicted that large nutrient pulses could be expected from stormwater wetlands at the end of the growing season. In fact, the highest soluble phosphorus concentrations leaving the wetland in baseflow were witnessed in the summer.

During much of the year, the wetland tended to be a slight exporter of particulate phosphorus and nitrogen. Apparently, the wetland "packaged" soluble nutrient forms into particulate ones through algal or plant uptake which were subsequently exported from the wetland. Part of the reason for the lack of a pronounced nutrient pulse at the end of the growing season may be that most of the plant nutrients were located below the sediment surface of the wetland.

The researchers also made an attempt to determine the fate of above-ground plant biomass using "litterbags" (mesh bags containing wetland plant matter that are measured over time to determine the rate of decomposition). They concluded that 40 to 65% of the above-ground plant biomass (and nutrients) could be retained in the wetland, and that the wetland was accumulating organic matter and nutrients over time.

The development of the wetland plant community in the first three years after its creation was recorded. Wetland plants quickly took over all the shallow depth zones and grew rapidly in biomass (200-600 gms ash free dry weight /m<sup>2</sup>). The wetland plant species coverage after two years is reported by depth zone in Table 2. Eighteen volunteer species had become well established in the wetland after two years. Cattails, spike rush, and duckweed were the most dominant invading species (the first two species were thought to be present in the seedbank of the site prior to construction).

Of the planted species, rice cutgrass had greatly expanded its coverage in the shallowest depth zones (zero to six inches) after two growing seasons. Both spatterdock and water lily expanded their coverage into the deeper areas. Interestingly, the investigators believed that the spatterdock was displacing cattails by

**Table 1: Pollutant Removal Performance of the Stormwater Wetland (Pollutant Mass Reduced During Both Storms) N=27 (OWML and GMU, 1990)**

Pollutant	Small Storms	All Storms
Ortho-phosphorus	59%	-5.5%
Total Soluble Phosphorus	66%	-8.2%
Total Phosphorus	76%	8.3%
Ammonia-Nitrogen	68%	-3.4%
Total Suspended Solids	93%	62.0%
Total Kjeldahl N	81%	15.0%
Nitrate+Nitrite N	68%	1.2%
Total Nitrogen	76%	-2.1%



the end of the growing season. While common three-square (*Scirpus americanus*) was still present in the plant community, it did not greatly expand its coverage in the first two years.

Although this undersized stormwater wetland did not perform well, the study did provide several insights into better stormwater design. Clearly, additional treatment volume beyond 0.1 watershed-inches was needed to assure good removal during larger storm events. Second, performance was compromised by both sediment deposition (loss of capacity) and resuspension. Perhaps a sediment forebay near the inlet might have improved overall performance.

On the positive side, the study showed that a reasonably diverse wetland plant communities could become rapidly established if a wide range of depth zones were provided. Lastly, the study of the internal plant nutrient dynamics indicated that most of the nutrients taken up by the wetland plants are stored in below-ground biomass or as organic detritus, and the much-feared end of season nutrient pulse may not be of critical importance.

—TRS

#### Reference

Occoquan Watershed Monitoring Lab and George Mason University. 1990. *Final Project Report: The Evaluation of a Created Wetland as an Urban Best Management Practice*. Northern Virginia Soil and Water Conservation District. 170 pp.

**Table 2: Dominant Plants Recorded in the Stormwater Wetland by Depth Zone After Two Growing Seasons (OWML and GMU, 1990)**

Depth Zone in Created Wetland	Dominant Species — % Cover*
0-6 inches above normal pool	<i>Juncus effusus</i> (soft rush) — 70%
0-6 inches below normal pool	<i>Leersia orzoides</i> (rice cutgrass) — 61% <i>Eleocharis obtusa</i> (spikerush) — 29%
6-12 inches below normal pool	<i>Typha latifolia/angustifolia</i> (cattail) — 45% <i>Eleocharis</i> — 41% <i>Leersia</i> — 30%
12-18 inches below normal pool	<i>Typha</i> — 68% <i>Ludwigia plustrus</i> (water purslane) — 16% <i>Eleocharis</i> — 13% <i>Lemna spp.</i> (duckweed) — 13%
18-30 inches below normal pool	<i>Lemna spp.</i> — 100% <i>Typha</i> — 90% <i>Eleocharis</i> — 50% <i>Nuphar</i> — 50% <i>Nymphaea odorata</i> (water lily) — 70%

\* percent of random 1 meter square quadrats where the indicated species was present.

## Article 91

Technical Note #78 from *Watershed Protection Techniques*, 2(2): 377-379

# Pollutant Removal by Constructed Wetlands in an Illinois River Floodplain

**R**ivers and their floodplains have been dramatically altered by man in the interest of flood control or navigation. Nowhere is this more evident than the urbanized Midwest. The Des Plaines River, located near Chicago, is an excellent example. The riparian ecology of this river and its floodplain has been severely altered by channelization over the last 50 years. Important functions such as flood control, wildlife habitat, wetlands and pollutant removal have all been sharply diminished.

Over the last 10 years, Hey and his colleagues (Hey *et al.*, 1994a, 1994b; Mitsch *et al.*, 1995; Sanville and Mitsch, 1994) have embarked on an ambitious effort to restore the drainage characteristics and habitat quality of the river, primarily through the construction of off-line wetlands within the river's floodplain. The wetlands were designed to mimic the complex interaction between a river and its floodplain. As part of the Des Plaines River Demonstration Project (Table 1), Hey and Mitsch have independently analyzed the capability of the off-line wetlands to reduce sediment and nutrient levels found in river runoff.

The Des Plaines River drains a watershed of 200 square miles, 80% of which is agricultural and the remainder urban. Four experimental wetlands (EWs) were placed in linear succession along the western bank of the river containing dense emergent wetland vegetation (Table 2). Ranging in size from five to 8.6 acres, and with maximum depths of five feet, each wetland received water diverted from the river through a pump and irrigation pipeline system. EWs three and five were subjected to high flow conditions (13.4 to 38.2 in/wk), while EWs four and six received lower flows (2.8 to 6.3 in/wk).

Pollutant levels were measured from flows entering and leaving each wetland. Since the wetlands received water from the same river source, only one inlet location was necessary to determine pollutant concentrations. All total suspended solids (TSS) and nitrate-nitrogen measurements reported by Hey *et al.* (1994a) were taken during the 1990 and 1991 growing seasons (April through September—Table 3). Phosphorous data reported by Mitsch *et al.* covered the 1990-1992 growing seasons.

Table 1: The Des Plaines River Demonstration Project

<b>Location:</b>	Upper Des Plaines River, Wadsworth, IL (35 miles north of Chicago)
<b>Land use:</b>	80% agriculture, 20% urban
<b>Watershed:</b>	200 mi <sup>2</sup>
<b>Objectives:</b>	<ul style="list-style-type: none"><li>• restore presettlement flora and fauna</li><li>• restore drainage characteristics associated with original creeks and floodplains</li><li>• create diverse wetland habitat</li></ul>
<b>Parties involved:</b>	Wetland Research, Inc. IL Dept. of Energy & Natural Resources U.S. Fish & Wildlife Service Lake County Forest Preserve District
<b>Wetlands:</b>	8 man-made wetlands ranging in size from 4.0 to 11.2 acres in size (data from 4 wetlands are in this Technical Note)
<b>Pollutants:</b>	Point and nonpoint; primarily sediment and nutrients
<b>Final products:</b>	<ul style="list-style-type: none"><li>• design manual laying out the conditions for creating wetlands</li><li>• operations manual describing methods and procedures for managing recreated wetlands (water level controls, public health, and pests)</li><li>• hour-long documentary on before and after conditions</li><li>• living example of the benefits wetlands can provide to a modern society</li></ul>



**Table 2: Dominant Vegetation in Four Illinois Constructed Wetlands (Mitsch *et al.*, 1995)**

Cattails  
 Reed canarygrass  
 Knotweed  
 Northern water plantain  
 Muskgrass  
 Red rooted spikerush  
 Water or marsh purslane  
 Sago pondweed  
 Broad-leaf arrowhead  
 Softstem bulrush\*

\* introduced to EWs 3 and 4 in 1989; flourishes in deepwater areas

The experimental wetlands showed great promise. Outlet concentrations of each pollutant were significantly lower than the concentrations found in the river water prior to wetland treatment (Table 3). Despite variable nutrient loading rates each year, the pollutant removal efficiencies were rather high, often greater than 80% (Table 4). Sediment settled out within the confines of the wetland, and of the TSS not removed through wetland processes, an average of 36% was converted to volatile compounds.

High removal rates were also reported for phosphorous, with 1992 data showing greater removal efficiency in the low-flow wetlands. Biological uptake and settling of phosphorous-bound solids accounted for the majority of its removal during the study. One factor believed to contribute to total phosphorus (TP) and TSS outlet concentrations was the resuspension of sediments by foraging fish. This speculation is partially supported by generally lower outlet TSS and TP concentrations during the 1991 growing season, after carp had been removed from the sites. The constructed wetlands also showed an ability to remove nitrate-N. Outlet concentrations from the constructed wetlands were comparable to concentrations observed in a natural system.

The high mass removal and consistently low outlet concentrations led Hey *et al.* (1994a) to reason that the experimental wetlands had not yet been loaded to full saturation capacity. Based on 1990 hydraulic loading rates to the experimental wetlands, Hey *et al.* (1994b) estimated that similar water quality improvement could be achieved in other northeastern Illinois watersheds if one to 5% of the watershed could be devoted to off-line wetlands located in the floodplain.

However, 1992 data revealed a slight decrease in phosphorus removal efficiencies, causing Mitsch *et al.* to cautiously raise the question of whether the wetland sediments might be beginning to experience phospho-

**Figure 1: Location and Flow Conditions of Four Experimental Wetlands at the Des Plaines River Wetlands Demonstration Project (Arrows Indicate Direction of Flow) (Hey *et al.*, 1995)**

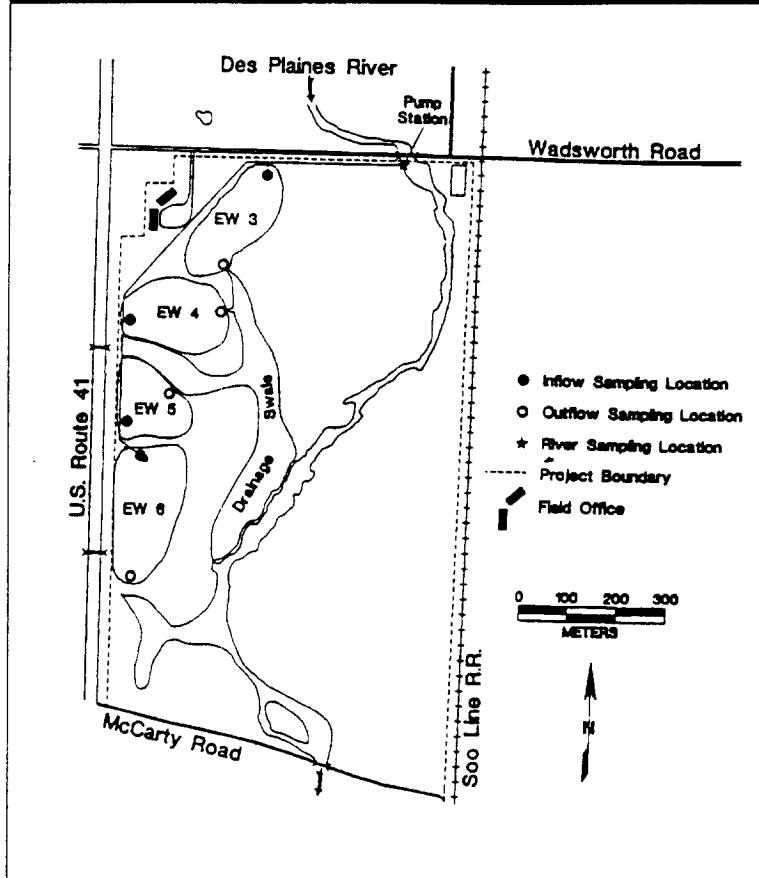

**Table 3: Average Inlet and Outlet Pollutant Concentrations for Four Constructed Wetlands Along the Des Plaines River, Illinois (Data from 9-25 Samples)**

	TSS (mg/L)	Nitrate-N (mg/L)
<b>1990</b>		
Inlet	78.1	1.87
EW3	6.8	0.54
EW4	13.7	0.24
EW5	5.8	0.53
EW6	8.1	0.32
<b>1991</b>		
Inlet	102.1	1.22
EW3	7.2	0.23
EW4	7.3	0.10
EW5	4.9	0.18
EW6	6.3	0.18



**Table 4: Pollutant Removal Efficiency (%) of Four Constructed Wetlands, Based on Mass Balance and Flux Analysis**

	1990				1991				1992
	TSS*	Nitrate-N*	TP*	TP**	TSS*	Nitrate-N*	TP*	TP**	TP**
EW3	79	79	66	63	95	86	89	86	53
EW4	77	39	52	81	94	95	98	98	87
EW5	92	80	75	63	99	92	99	96	78
EW6	~100	99	99	99	~99	99	~100	99	83

\* Hey *et al.*, 1994a

\*\* Mitsch *et al.*, 1995

rous saturation. In the future, researchers plan to increase hydraulic loading rates to the wetlands in an effort to more fully ascertain their long-term pollutant removal potential. Such continued efforts can help resolve the questions of whether constructed wetlands have a limited life span for consistently treating pollutant-laden waters and how much watershed area should be devoted to floodplain wetlands to protect water quality. Long-term monitoring of pollutant removal and changes in wetland plant communities will be useful to managers considering riverine "floodplain" wetlands as a large-scale watershed protection technique in rivers dominated by nonpoint source pollution.

The Des Plaines River experience suggests that reconnecting a river to its floodplain via constructed wetland systems can be an effective watershed protection technique in developed communities where rivers have been extensively channelized in the past and little land area is available for wetland construction in the headwaters of the watershed. In addition to significant pollutant removal, the wetlands can also provide greater fish and wildlife habitat, and possibly greater flood control storage. However, such systems need to be carefully designed so that they do not increase local

flood elevations. In addition, they may require constant maintenance and power to direct river water into the floodplain, and then back into the river.

-RLO/TRS

#### References

- Hey, D.L., A.L. Kenimer, and K.R. Barrett. 1994a. "Water Quality Improvement by Four Experimental Wetlands." *Ecological Engineering* 3: 381-397.
- Hey, D.L., K.R. Barrett, C. Biegen. 1994b. "The Hydrology of Four Experimental Constructed Wetlands." *Ecological Engineering* 3: 319-343.
- Mitsch, W.J., J.K. Cronk, X. Wu, R.W. Nairn, and D.L. Hey. 1995. "Phosphorus Retention in Constructed Freshwater Riparian Marshes." *Ecological Applications* 5(3): 830-845.
- Sanville, W. and W.J. Mitsch (eds). 1994. "Creating Freshwater Marshes in a Riparian Landscape: Research at the Des Plaines River Wetlands Demonstration Project." *Ecological Engineering* 3, special issue.

# Pollutant Dynamics Within Stormwater Wetlands: I. Plant Uptake

Plants in a constructed wetland function to physically slow the flow of water and cause suspended particles to fall out; provide a substrate on which associated microbes assimilate organics, metals, and nutrients; and take up pollutants from the sediment into the roots. It is arguable whether this last function is really desirable in either constructed or natural wetlands.

A key management question is whether pollutants that are deposited in wetland sediments are incorporated into wetland plant tissue. Will toxic metals and hydrocarbons interfere with plant growth and nutrient uptake? Pollutants that are deposited in the stormwater wetland can remain in the pond muck, be taken up by plant roots below ground, or be taken up into the shoots (Figure 1). Will nutrients be released back into the water when the plants die back in the fall? Is there a risk that waterfowl that feed on wetland plants will be affected? Which plants are most sensitive to metal pollutants and which are most efficient at accumulating pollutants? A study by the city of Seattle (1993) addresses some of these questions.

The South Base bus maintenance site is a good example of a hydrocarbon "hotspot" in the sense that while good stormwater practices are in place and the site is well managed, it is an area of high impervious cover and vehicular traffic: 18.5 acres of vehicle maintenance area and parking lots. The city converted a dry detention pond to a 0.56 acre constructed wetland in 1988 in order to improve outflow water quality and study plant uptake of zinc, lead, and total petroleum hydrocarbons (TPH). Five plant species were chosen for intensive study: common cattail (*Typha latifolia*), water flag (*Iris pseudacorus*), burreed (*Sparganium* sp.), blunt spike-rush (*Eleocharis ovata*), and hardstem bulrush (*Scirpus acutus*) which grew in monospecific stands in the pond.

Both the amount of pollutants taken up and the area covered by the different species were measured in order to find the species that is most efficient for pollutant removal (having highest uptake per area of cover). Daily and seasonal changes in water level, rainfall, and plant biomass were recorded. During the summer, whole plant specimens were harvested, and samples of above- and below-ground tissue and surrounding soil underwent chemical analysis. Samples were analyzed for lead, zinc, TPH, nitrogen, and phosphorus.

The data were analyzed separately for roots and shoots and pooled for whole plant uptake. South Base Pond plants and sediments were compared with uncontaminated controls. Summarized results for cattail are presented in Table 1.

Of the five species at South Base wetland, cattail was most efficient at taking up pollutants. While concentrations of lead, zinc, and TPH were actually highest in burreed tissue, cattail was more vigorous and therefore had the greatest pollutant uptake per area of cover. Pollutant concentrations were also high in spike-rush tissue but this species ranked fourth in vigor. Whether this or any species was growing at less than full potential because of its high pollutant uptake is a question not addressed in this study.

Previous research has indicated that metal uptake is species specific, and for most aquatic plants the bulk of pollutants are stored in the roots and not the stems and leaves (although zinc is more mobile than lead (Lepp, 1981)). This finding was confirmed for the five wetland plants at South Base. The key result of this study is that concentrations of TPH, zinc, and lead were higher in the root than the shoot (Figure 2). Biofiltration by plants only works if the pollutants are settling to the bottom—plants do not take up appreciable amounts from the

Sediments, nutrients, trace metals, and hydrocarbons enter the pond during storms. The pollutant load varies depending on the land use near the pond. Pollutant particles are deposited in the muck layer, where they are usually bound (1). Some pollutants may migrate further. Studies show that plants uptake metals in the sediments into the roots (2). A very small concentration of metals enters via the water column and a small concentration leaves the roots to enter the shoots (3).

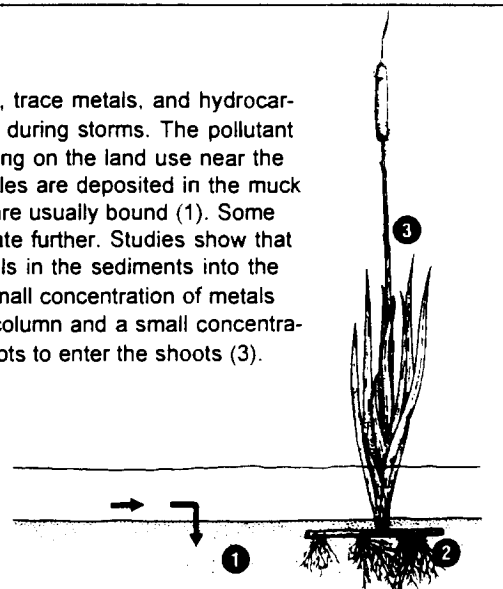

Figure 1: Pollutant Pathways in a Wetland



**Table 1: Pollutant Concentrations in Cattail (ppm)**

	TPH	Lead	Zinc
Roots*	2,867	17.2	125
Shoots*	516	1.37	31
Soils*	3,907	107	292
Pond muck from typical urban wetland**	ND	330	163

\*average of means from three sampling dates

\*\*Schueler, 1995

water column. Roots not only directly take up pollutants but also oxidize surrounding soil, enabling microbes to assimilate pollutants.

It might seem that because these pollutants are stored in the roots and rhizomes of plants, we need not be concerned about risks to animals that consume the vegetation (unless the roots are eaten) or export of pollutants to water supplies when the shoots die back.

However, it must be noted that South Base Pond is a newly constructed wetland, and few studies exist concerning pollutant fate in aged wetlands. It is not known what happens to root pollutants as perennial plants age. The whole plant, including the root, eventually dies, and pollutants may be given off along with the decaying material. Even before decay, a point may be reached where living root tissue begins to leak. Indeed, root leakiness (membrane permeability to ions) is aggravated by uptake of zinc (Lepp, 1981).

According to Shutes *et al.* (1993), pollutant-laden plants need not be harvested because the pond muck will be covered by less-polluted incoming sediment. This cannot be expected at a hotspot site like South Base where incoming sediment is always contaminated. Sites like these must undergo periodic dredging of at least the forebay to remove overly polluted sediment. If a particular site is known to receive heavy metals and petrochemicals then some thought should be given to whether it is desirable to attract wildlife by providing food plants—especially edible roots. At any rate, it is generally agreed that wetlands not be used as the first

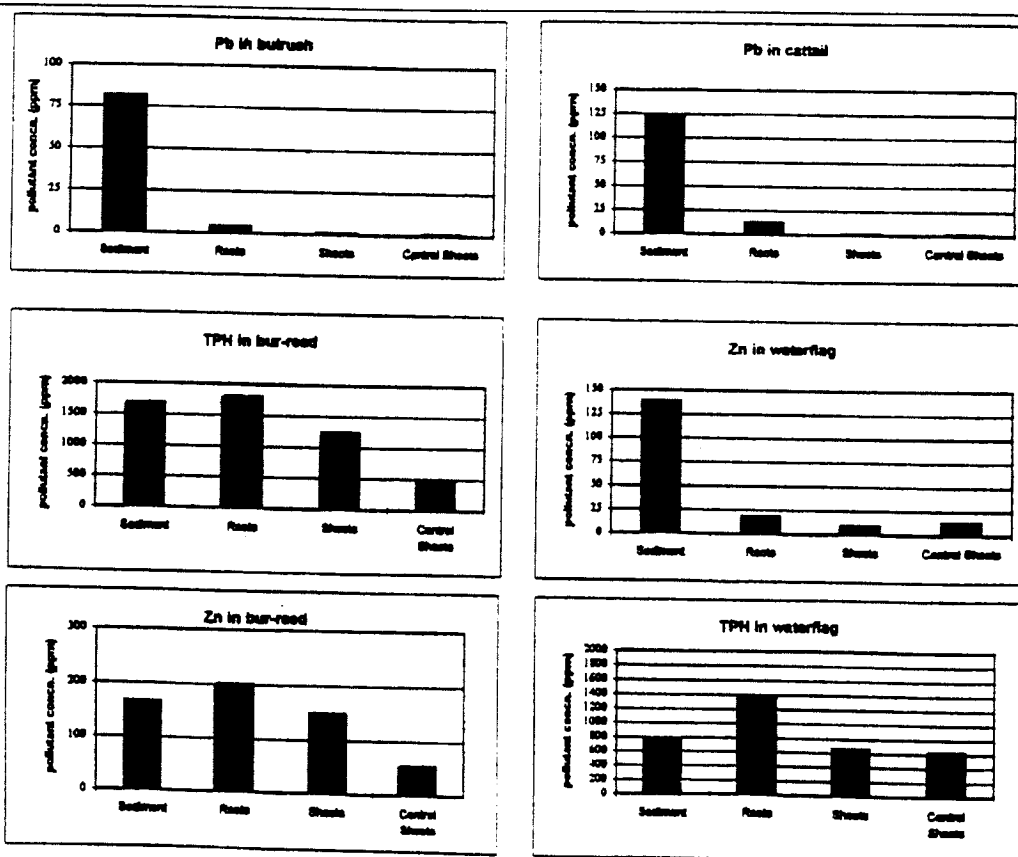

For some pollutants and some species the combined pollutant concentration from the whole plant—root plus shoot—is still significantly less than what is left in the surrounding soil, while in other cases just the reverse is true. Pollutant uptake is species specific. However, note that in all cases, including those not shown, pollutant concentration was higher in below-ground material (roots) than in the emergent vegetation (shoots). In most cases, the level of pollutants in shoots from the stormwater pond were not much different from unpolluted controls; Zn in burreed is an exception.

**Figure 2: Selected Data Sets for Wetland Plants at South Base Pond**

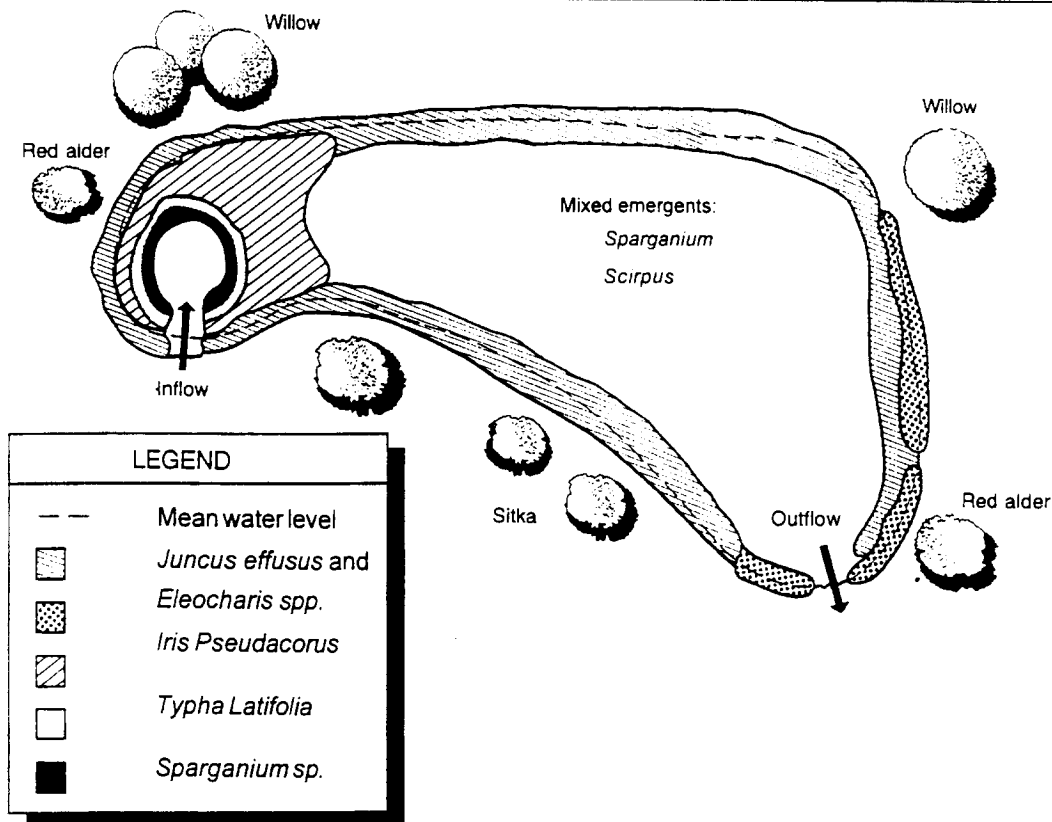

Figure 3: Vegetation Plan for South Base Pond, Seattle (Seattle Metro, 1993)

interceptor of stormwater. Constructed wetlands in high-hydrocarbon sites should be placed in series after other devices such as the coalescing plate or API water/oil separators at this site.

The following recommendations emerged from the South Base study:

1. Control the source of pollutants (especially oil spills) where possible. Place a primary treatment system, such as a sand filter or detention pond, prior to the marsh and install floating booms on the deep forebay of the marsh. Create a deep forebay that can be accessed for future dredging if necessary.
2. Create a gentle pond slope for good plant establishment and diversity. Design for moderate water level fluctuations. Most wetland plants thrive in consistently shallow water.
3. Plant primarily rhizomatous perennials with long growing seasons.
4. Use cattail near the inflows. Prevent this species from taking over the whole marsh by thinning and harvesting immature fruit. Choose adjacent species that are not likely to be shaded out (Figure 3).

#### Update

Plans are being made for the harvesting and dredging of South Base and an overall management of King

County Metro's 11 constructed wetlands. Vegetation is well established. Permanent and transient wildlife—ducks, songbirds, mammals, reptiles - have been observed using the pond. There are no amphibians and fish, as the pond dries up in September.

Three years of outflow monitoring show consistently low concentrations of TPH and Pb and Cu. Zn is as high as 330 ppb but averages 80 ppb; fluctuations are non-seasonal. The pond becomes anaerobic and odiferous in dry periods.

—JMC

#### References

- Koeppel, D. E. (Chapt. 2) and J. C. Collins (Chapt 5) In: *Effect of Heavy Metal Pollution on Plants* (vol. 1, ed. N. W. Lepp), NJ: Applied Science Pub. 1981.
- Schueler, T. 1995. "Pollutant Dynamics of Pond Muck." *Watershed Protection Techniques* 1(2): 39-46.
- Seattle Metro. 1993. *South Base Pond Report: The Response of Wetland Plants to Stormwater Runoff From a Transit Base*. Pub. No. 775, August 1993.
- Shutes, R. B., J. B. Ellis, D. M. Revitt, and T. T. Zhang. 1993. "The Use of *Typha latifolia* for Heavy Metal Pollution Control in Urban Wetlands." *Constructed Wetlands for Water Quality Improvement*, ed. G. A. Moshiri, CRC Press.



## Article 93

Technical Note #54 from *Watershed Protection Techniques*, 1(4): 214-216

# Pollution Dynamics Within Stormwater Wetlands: II. Organic Matter

**W**etland designers use basic parameters such as surface area, rainfall frequency, input concentrations, and overflow rates to design wetlands to achieve a desired nutrient removal rate. While this approach has proven effective for secondary wastewater treatment, much less is known about wetlands designed for stormwater runoff.

Great variation exists in the pollution pathways of stormwater runoff. "Black box" studies of constructed wetlands, in which inflow and outflow concentrations are measured to yield the mass balance, tell us part of the story. We still don't really know where exactly in the system the bulk of nutrients are being removed. Pollutant pathway studies in mesocosms can tell us more about the relative importance of the individual nutrient removal processes (e.g., filtration, adsorption, ion exchange, assimilation, denitrification) and consequently the suitability of one wetland design or another for stormwater treatment.

Existing data on the nutrient removal rates of stormwater ponds and wetlands vary considerably due to the differences in type, location, size, maintenance, or age of the wetlands. "Wetlands" span the continuum from ordinary wet ponds to carefully planted marshes. Some argue that the vegetation in constructed wetlands is superfluous because the nutrient removal depends only on the surface area of muck. By examining sediment, water (plankton), and vegetation pathways separately, we can identify the key components in a stormwater wetland design.

Controlled experiments with mesocosms make it possible to both study individual nutrient pathways in isolation and control inflow nutrient concentrations to see how removal pathways respond to input concentrations. If enough data are gathered, equations can be derived which water quality managers can actually use to predict the efficiency and load capability of different wetland designs.

Table 1: Removal Rates (mg/m<sup>2</sup>/day) and Efficiencies (% Decrease per Day) of Mesocosm Components (Johengen and LaRock, 1993)

	Nitrate N		Ammonium N		Phosphate P	
	Rate	Eff.	Rate	Eff.	Rate	Eff.
<b>Summer</b>						
Plants (growing in sediment)	270	96	246	93	202	72
Sediment alone (unvegetated)	188	76	210	87	185	78
Plants alone*		20		6		0
Water column (plankton)	55	22	155	65	86	37
<b>Fall</b>						
Plants	145	35	285	75	281	73
Sediment alone	72	17	164	43	228	68
Plants alone*		18		32		5
Water column	8	3	64	30	11	4

\* Not physically measurable, for comparison only, obtained by subtracting sediment alone from sediment plus plants.  
Note: Efficiencies but not rates can be compared between seasons since different influx concentrations were used (0.5 mg/l in summer and 1.5 mg/l in fall for each nutrient).

### Are Wetland Plants Really Necessary?

There are multiple removal pathways in pond sediments: pollutants may be broken down through physical and biological processes in the top muck layer and parent soils underneath, some pollutants return to the water column, and nutrients are taken up by plants (Figure 1). In one mesocosm experiment (Johengen and LaRock, 1993), vegetation rooted in sediment was found to be effective at removing nitrogen and phosphorus, but so was unvegetated sediment. In another mesocosm experiment, Crumpton (1993) found little difference between mesocosm cells with plants and those containing unvegetated sediments. Indeed, the amount of nitrate removed could be predicted solely as a function of the inflow concentration. The living plants themselves accounted for little of the nitrogen removal through uptake (Table 1). However, the removal processes that occur in the sediment are dependent on the deposition of organic matter, which increases as the vegetation becomes more established. The plants provide a necessary litter layer and aerobic zone for microbial activity and more significantly, the supply of organic carbon (decaying plants) to promote the denitrification process.

Bare or newly planted wetlands can be jump-started in effect by adding "detritus" (such as hay or leaf litter) in the first season. Thereafter, stormwater wetlands are self-sustaining, high-capacity nitrogen removers, unlike wastewater wetlands which operate on a different principal. In this sense, the vegetation is essential to the system. Mature vegetated wetlands have a removal capacity that is as much as five times higher than the unvegetated zones (Crumpton, personal communication). Because it is the *supply of organic carbon* that determines nutrient removal - much more so than uptake by living plants - nitrogen removal can be expected to continue after the plants have died back in the fall, except where the soil is completely frozen.

The contribution of the substrate micro-organisms in phosphate removal is also stressed in these studies (Figure 2, Table 1). Like nitrate removal, phosphate removal rates are greater in the sediments than in the water column. Phosphate removal in vegetated and unvegetated sediment remains high in the fall, after the plants have died back. In the vegetated sediment experiments, the sediment accounted for 80 to 100% of the phosphorus removal (Johengen and LaRock, 1993).

### How Much Nitrogen Can a Wetland Take?

The chemical conditions suitable for the denitrification process that converts nitrate to nitrogen gas exist

1 Nitrogen in sewage wastewater is in the form of ammonium, not nitrate. Ammonium denitrification requires aerobic conditions - the reason for aerating devices in some of these systems. Also, the phosphorus in the wastewater system will be higher than in a typical stormwater wetland.

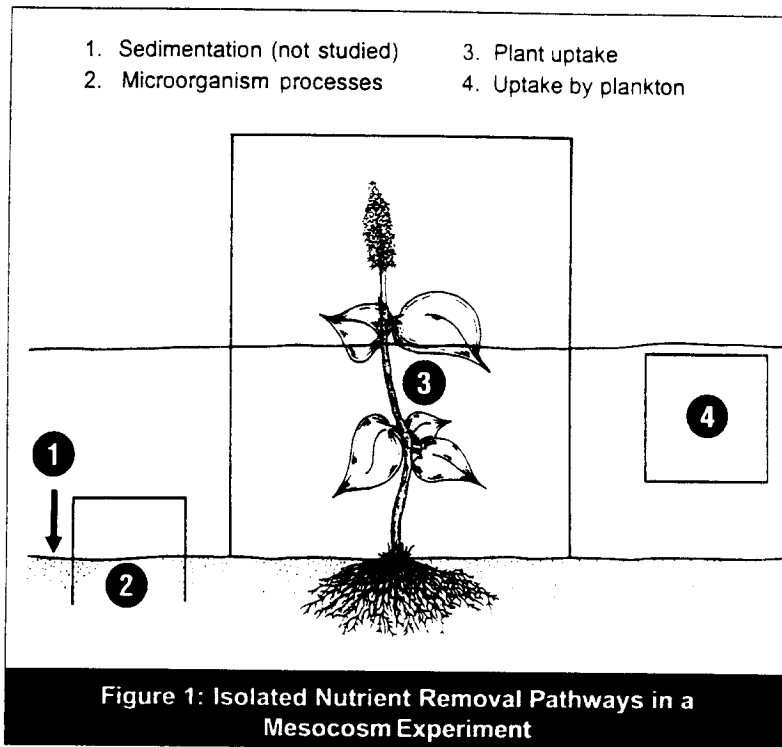

Figure 1: Isolated Nutrient Removal Pathways in a Mesocosm Experiment

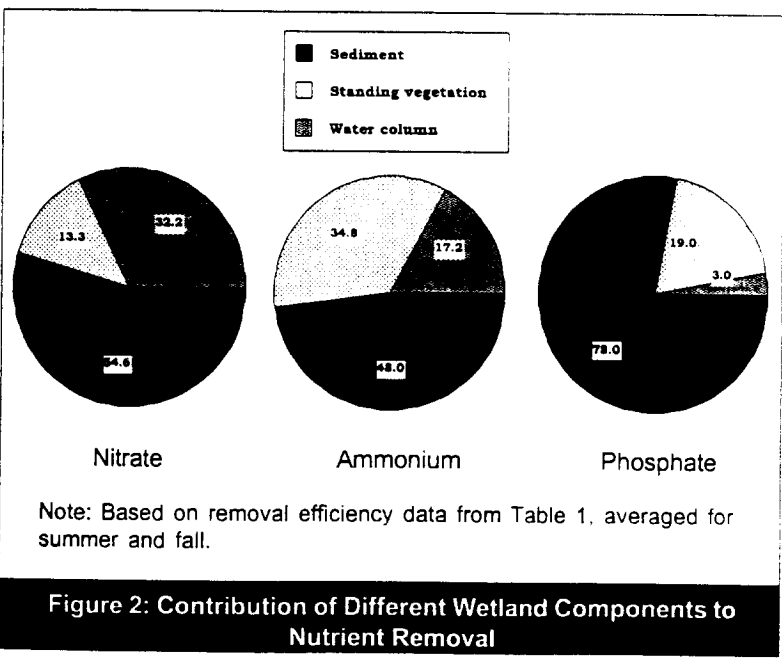

Figure 2: Contribution of Different Wetland Components to Nutrient Removal

in wetlands but few actual measurements of denitrification have been made. In controlled mesocosms, Crumpton found that the denitrification rate was only limited by the amount of nitrate put in; a higher influx resulted in higher nitrate processing. It would at first seem unlikely that removal could continue indefinitely. In Crumpton's mesocosms, a dose of 8 mg/l N was completely removed in five days and 20 mg/l was removed in seven days—a time period within the residence time of a typical wetland.

R0079940

**Table 2: Stormwater Wetland Mesocosm Studies**

	<b>Johenegen and LaRock, 1993</b>	<b>Crumpton, 1993</b>
<b>Site</b>	Jackson Co., Florida	Iowa State Univ. Experimental Farm
<b>Type</b>	Newly constructed filtration impoundment/artificial marsh built on stream, designed to receive stormwater from urbanized watershed: "mesocosms" are Plexiglass isolation chambers (Figure 1).	1. Array of 48 mini-wetlands (polyethylene cells) containing planted cattail. 2. Bench-top micro-chambers for sediment-only study.
<b>Dimensions</b>	2.5-ha marsh 45 cm deep (avg), 2 m deep outfall pool.	Wetland cells: 3.35 m diam., 90 cm deep, 60 cm soil. Microcosms: 2-in. diam. sealable cells for tracer injection into sediment and gas measurement
<b>Soil</b>	Clay bottom, some detritus	Obtained from a drained wetland
<b>Vegetation</b>	Planted <i>Pontedania</i> , volunteer duckweed	Planted cattails
<b>Methodology</b>	Isolation, controlled enrichment (nitrate, phosphate, ammonium), and sampling (for inorganic and organic solids, total phosphorus and nitrogen, ammonium and nitrate, orthophosphate, chlorophyll-a, and dissolved oxygen) of bare sediment, plankton in water column, and aquatic plants (rooted in sediment) in Plexiglass chambers; values of nutrient uptake from these isolated pathways compared with overall inflow/outflow measurement.	Mesocosms tested for repeatability and approximation to natural systems after one growing season; static and flow-through wetland cells given controlled enrichment, concentration of nitrate in water measured. Bench-top sediment-only cells injected with isotope tracer to measure denitrification rate.
<b>Results</b>	<ul style="list-style-type: none"> <li>• pH and dissolved oxygen not a factor in nutrient removal</li> <li>• Plant systems most effective in removing nitrogen (ammonium and ammonia the same)</li> <li>• Sediment most effective in removing phosphate, ammonium removed at a greater rate than ammonia</li> <li>• Water column (plankton) removal efficiency poorer than plants and sediment (half the phosphate); ammonium assimilated over ammonia</li> <li>• High phosphorus removal capacity of the sediments makes possible nutrient removal at low N:P ratios</li> <li>• Duckweed had significant N and P removal effect in sediment and water column chambers but not in macrophyte chambers (probably out-competed)</li> <li>• Removal rates in sediment and water column increased with higher concentration</li> </ul>	<ul style="list-style-type: none"> <li>• Nitrate removal in wetlands can be modeled based solely on nitrate influx and diffusion path from anaerobic sediment to surface</li> <li>• Decaying plant litter provides the site for denitrification</li> <li>• Sealed microcosm experiments with labelled nitrogen confirm that nitrate removal rate is linear and increases with increasing influx concentration. Later sealed mesocosm results also confirm this.</li> </ul>

Crumpton conducted further studies for longer time periods and at higher influx concentrations (30 mg/l, the upper limit of agricultural waste) and still saw a 10 to 25% daily nitrogen removal. Crumpton's mesocosm results suggest that well-designed stormwater wetlands can achieve higher nitrogen removal rates than are customarily measured in mass balance studies where removal seldom exceeds 40 to 50% (Schueler, 1994). Longer residence times, a larger supply of organic matter, and shallower water depths all appear to be design variables worth pursuing.

—JMc

**References**

Crumpton, W. G., T. M. Isenhart, and S. W. Fisher. 1993. "Fate of Non-Point Source Nitrate Loads in Fresh Water Wetlands: Results From Experimental Wetland Mesocosms." *Constructed Wetlands for Water Quality Improvement*, ed. G. A. Moshiri, 632 pp. Lewis/CRC Press.

Johenegen, T. H., and P. A. LaRock. 1993. "Quantifying Nutrient Removal Processes Within a Constructed Wetland Designed to Treat Urban Stormwater Runoff." *Ecological Engineering* 2: 347-366.

Schueler, T. R. 1994. "Review of Pollutant Removal Performance of Stormwater Ponds and Wetlands." *Watershed Protection Techniques* 1(1): 17-19.

**R0079941**





## Article 94

Technical Note #77 from *Watershed Protection Techniques*, 2(2): 374-376

# Pollutant Removal Capability of a "Pocket" Wetland

Many stormwater engineers now employ small pocket ponds or wetlands to treat stormwater runoff generated by smaller development sites. The term "pocket" refers to a pond or wetland that has such a small contributing drainage area that little or no baseflow is available to sustain water elevations during dry weather. Instead, water elevations are heavily influenced and, in some cases, maintained by a locally high water table. Until recently, very little was known about the pollutant removal performance of pocket wetlands or ponds. However, recent research and monitoring by Betty Rushton and Craig Dye in southern Florida has greatly increased our understanding of these systems. They recently completed a comprehensive analysis of a "pocket" wetland draining a six-acre office park near Tampa Bay, Florida. Their monitoring study examined storm dynamics and pollutant behavior at the facility over a two-year interval. In addition, they examined local groundwater interactions, accumulation of priority pollutants in pond sediments, and the pollutant chemistry of rainfall.

Constructed in 1986, the pond had a very small surface area (0.32 acres), was sized to provide a half-inch of runoff storage for water quality treatment, and had additional temporary detention of larger storms for peak-shaving purposes. Although the authors did not report the impervious cover for the site, they did compute a storm runoff coefficient of 0.32.

Runoff to the pond was conveyed by a 200 foot long grassed drainage channel, which may have provided partial pretreatment. The shallow pond (maximum depth of 18 inches) was sandwiched between two adjacent forested wetlands and had a flat bottom (see Figure 1). Pond water levels fluctuated during the year, drying out entirely during the dry season and then filling to the full 18 inch depth in the normally wetter "summer" season. Originally planted with arrowhead and pickerelweed, nearly 95% of the wetland surface area is now covered by cattail and algal mats.

For these reasons, the study pond can probably best be described as a pocket wetland, although it is technically considered a wet detention pond under Florida design guidelines. Hydrologic monitoring indicated that the pocket wetland had a mean residence time of 3.7 days on an annual basis, and a slightly shorter residence time (2.1 days) during the summer "rainy season." Physical monitoring indicated that the pocket

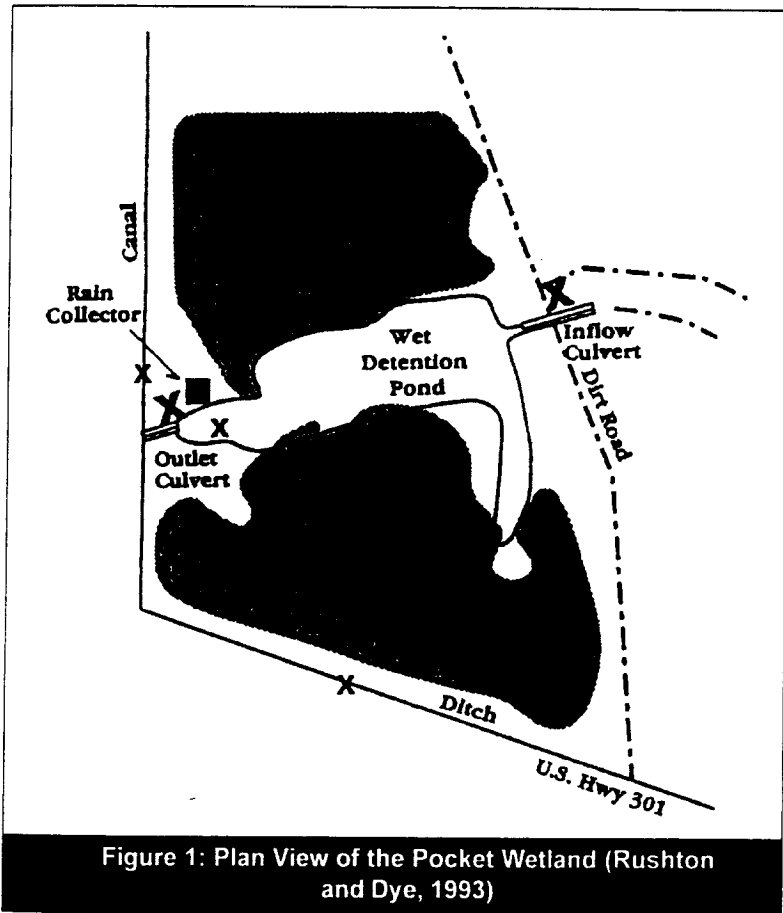

Figure 1: Plan View of the Pocket Wetland (Rushton and Dye, 1993)

wetland was strongly influenced by biological activity. For example, summer sampling showed a pronounced diurnal swing in dissolved oxygen in the pocket wetland, with complete nighttime anoxia followed by a partial daytime recovery to about four to five mg/l.

Rushton and Dye collected flow-weighted composite samples from the inflow and outflow of the pocket wetland over 39 storm events over a two-year period. The computed removal efficiency of the pocket wetland is described in Table 1, and is expressed in terms of both concentration and mass load reduction. In general, the pocket wetland exhibited moderate to high capability to remove pollutants in stormwater runoff. Sediment, phosphorus and nitrate removal ranged from 50 to 70%. Removal of ammonia, organic nitrogen and zinc, however, was relatively modest, ranging from zero to 50%. This low removal may merely reflect the fact the incom-

8

R0079942

**Table 1: Measures of Pollutant Removal Performance of the Tampa Bay Office Park "Pocket Wetland" (Rushton and Dye, 1993)**

Parameter	Sampling Interval		
	Summer 1989	6/90 to 6/91	6/90 to 6/91
Number of Storms	8-11	23-27	23-27
Removal Method	Change in EMC	Change in EMC	Mass Load
TSS	71	57	55
Total Phosphorus	46	57	65
Ortho-phosphorus	55	66	67
Nitrate-Nitrogen	70	67	65
Organic-Nitrogen	(-20)	3	59
Ammonia-Nitrogen	44	20	39
Zinc	5	42	51

Notes: EMC = event mean concentration. Cadmium and Copper were also measured, but were not detected frequently enough to calculate removal efficiency.

**Table 2: Mean Outflow Concentrations From Tampa Bay Office Park "Pocket Wetland"**

Parameter (mg/l)	Summer 1989	6/90 to 6/91	Background*
TSS	7.7	11.8	32
Total Phosphorus	0.18	0.17	0.19
Ortho-phosphorus	0.13	0.10	0.08
Nitrate-nitrogen	0.10	0.08	0.35
Organic-nitrogen	1.32	0.93	1.29
Zinc	0.035	0.030	0.033**

\* Mean values for stormwater wetland effluent concentration from article 65.  
 \*\* Mean Florida pond/wetland zinc effluent concentration reported by Kehoe et al. (1993).

**Table 3: Comparison of Pollutant Concentrations in Rainfall and Runoff at the Tampa Bay Office Park "Pocket Wetland"**

Parameter (No. of samples)	Rainfall/Runoff EMC*
TSS (19)	6 %
Total Phosphorus (19)	2 %
Ortho-Phosphorus (26)	4 %
Nitrate-Nitrogen (28)	121%
Organic Nitrogen (TKN-26)	33%
Total Nitrogen (26)	45%
Ammonia-Nitrogen (28)	366%
Total Zinc (21)	68%

\* Rainfall concentration as a percentage of stormwater runoff concentration

ing pollutant concentrations were quite low, often very close to the "irreducible" concentration (Table 2). A comparison of the pocket wetland's effluent concentration with other national and regional estimates of the "irreducible" concentration appears to confirm this. In general, the authors reported pollutant removal rates for the pocket wetland that generally fell within the mid-range of pollutant removal estimates for other larger wet ponds previously monitored in Florida.

Priority pollutant scans of bottom sediments at both the inlet and the outlet generally indicated that this relatively young wetland (three to five years old) had not yet accumulated high levels of pollutants within its sediments. Only eight of 83 priority pollutants were detected in the two sediment samples. Low level detections included several automotive-derived PAHs, (pyrene, flouranthene, benzo(b/k) flouranthene, and di-n-octyl-phthalate), as well as several priority pollutants commonly associated with plastics or treated paper, and one persistent insecticide.

On-site samplers also recorded the chemistry of rainfall at the site, which allowed for a direct comparison of the concentration of pollutants present in rainfall with those found in storm runoff. Table 3 presents their findings. As can be seen, rainfall is often a primary, if not dominant, source of many pollutants of concern. For example, rainfall concentrations of ammonia, nitrate, and zinc approach, and, in some cases exceed, those found in stormwater runoff. As might be expected, these pollutants did not often exhibit a pronounced "first flush behavior," although phosphorus and some metals often did exhibit declining concentrations during the course of the storm. Highest sediment concentrations coincided with the peak of the hydrograph.

Although the pocket wetland performed reasonably well, it did not achieve the 80% removal rate target set forth for Florida waters. To further enhance its performance, the authors recommend designing ponds to achieve a minimum 14-day residence time, maintaining aerobic bottom sediments (e.g., through greater depth or physical aeration), improving pretreatment, and eliminating dead storage areas. The pocket wetland has been significantly redesigned in the last two years to attempt to improve its performance. Initial results appear very promising, and a final monitoring assessment should be completed by the end of 1996.

-TRS

**References**

Rushton, B. and C. Dye. 1993. *An In-Depth Analysis of a Wet Detention Stormwater System*. Southwest Florida Water Management District. Brooksville, FL.  
 Rushton, B., C. Miller, and C. Hull. 1995. "Residence Time as a Pollutant Removal Mechanism in Stormwater Detention Ponds." *4th Biennial Stormwater Research Conference*. SFWMD. Brooksville, FL. Oct. 18-20, 1995.

# Performance of Gravel-Based Wetland in a Cold, High Altitude Climate

A recent study by John Reuter and his colleagues provides new insights about the performance of stormwater wetlands in tough climates. The study team investigated the nutrient removal capability of a small wetland in the high altitudes of the Lake Tahoe Basin of California. The average precipitation in this mountainous region is a scant 20 inches a year, much of which is in the form of snowfall. The spring melt of the snowpack produces a sharp increase in runoff. The summers are hot and dry, and produce little runoff during the short growing season. Fall rainstorms are also an important part of the water balance.

The mountainous region has granitic soils that are very poor in nutrients. Consequently, the region's exceptionally clear mountain lakes are highly oligotrophic, and are very sensitive to nutrient enrichment. As a result, communities have taken stringent measures to limit nutrient inputs into their sensitive lakes, including stormwater treatment options. Prior studies have shown that the ability of stormwater wetlands to remove nutrients can decline in the winter months especially when runoff is dominated by snowmelt (Oberts, 1994). The climate of the Lake Tahoe region presents a difficult challenge for removing nutrients through conventional stormwater wetland designs.

The study is intriguing not only for its location, but for its design. Most stormwater wetland designs have followed the traditional "impoundment" model. In this model, a site is excavated to form a very shallow pool, and emergent wetlands are rooted in the sediment. The primary pollutant removal mechanisms involve settling, and the adsorption of pollutants to sediments, detritus or plant stems. Actual pollutant uptake by the wetland plants themselves is incidental. In the Tahoe study, the stormwater wetland was designed using the "underground" model, which has been extensively used for the treatment of wastewater. In this design, runoff is directed into a gravel layer in which the wetland plants are rooted. Consequently, the wetland plants can directly take up pollutants from their roots, and the gravel medium also acts as an effective filtering mechanism (Figure 1).

The Tahoe stormwater wetland treated the runoff produced from a 2.5 acre recreational area, most of which was a fertilized ballfield (i.e., no impervious cover). The wetland was rather small (0.16 acres in size), composed

of transplanted cattails that had not become fully established during the course of study. The bottom of the wetland was sealed with a liner, and filled with a three foot deep layer of fine gravel. Runoff was introduced into the gravel layer in a perforated pipe; outflow was collected by means of perforated pipe located in a standing well. Thus, runoff had to pass through the entire gravel filter before leaving the wetland. In general, the gravel layer was anaerobic (no oxygen), except for the top few inches. The bottom of the gravel layer was "inoculated" with muck from an adjacent wetland to introduce denitrifying bacteria into the system.

The stormwater wetland was monitored over a 18-month period, which included two winters. Most of the flow during the sampling period was generated by snowmelt, although the largest single runoff event was associated with a fall thunderstorm. Incoming nutrient concentrations were fairly low in comparison with other urban runoff datasets-averaging 0.05 to 0.30 mg/l for nitrate, 0.5 to 1.5 mg/l for TKN, and 0.15 to 0.25 for total phosphorus. The sampling design did not permit the

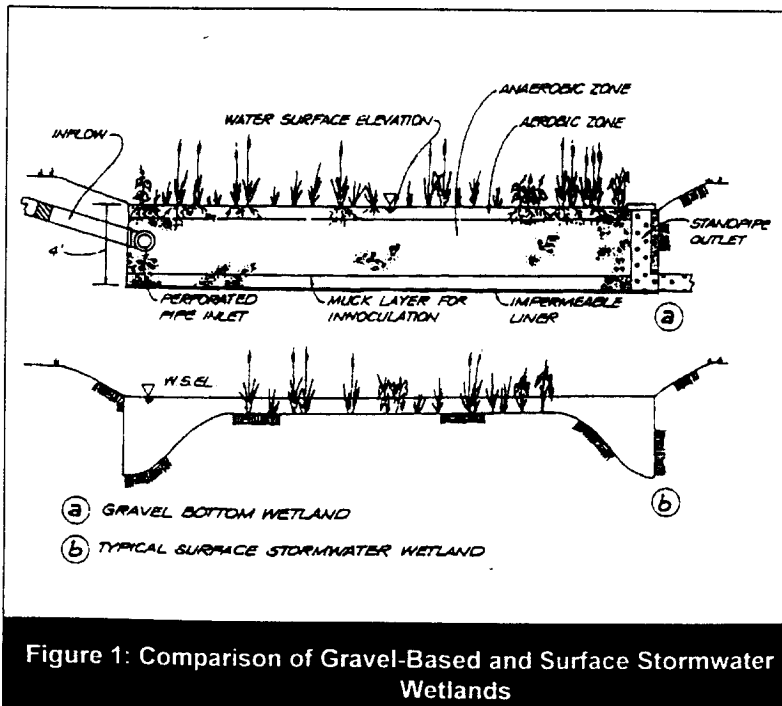

**Figure 1: Comparison of Gravel-Based and Surface Stormwater Wetlands**



**Table 1: Estimated Pollutant Removal Performance of the Lake Tahoe Gravel Stormwater Wetland (Reuter et al., 1992)**

Water Quality Parameter	Mean storm removal (%)
Suspended sediment	80 to 88
Particulate phosphorus	44 to 47
Soluble reactive phosphorus	-28 to -41
TKN	-3 to -14
NH <sub>4</sub>	-53 to -58
Nitrate	85 to 87
Total iron	80 to 88
Souble iron	72 to 78

direct measurement of runoff volumes entering and exiting the wetland, so the performance estimates were based solely on the change in nutrient concentration through the wetland. The results are shown in Table 1.

The gravel-based stormwater wetland proved to be very effective in removing particulate pollutants, such as sediment, iron and particulate phosphorus. Nutrient removal, however, was much more complex. Consider the nitrogen dynamics in the wetland. Soluble nitrogen forms, such as nitrate were removed at a high rate. Evidently, the anaerobic conditions in the wet gravel layer created ideal conditions to promote the denitrification process (the bacterial conversion of nitrate into nitrogen gas).

The wetland was not effective in removing organic nitrogen (TKN), and actually acted as a net source (-3 to -14% removal). The authors speculated that the source of the excess organic nitrogen was cattail detritus. On a positive note, the wetland did act as a sink for organic nitrogen under three conditions (1) during the warmer months, (2) when organic nitrogen concentrations in incoming runoff were high or (3) incoming runoff volumes were relatively low. The stormwater wetland also exhibited poor removal of ammonium (-53 to -58%), which was thought to be due to the mineralization of organic nitrogen in the gravel. Ammonium removal due to the nitrification process (bacterial conversion of ammonium into nitrate-nitrogen) was generally not possible since this process requires aerobic conditions in the gravel layer that were seldom present.

Phosphorus removal in the wetland was also mixed. Particulate phosphorus (PP) was consistently trapped in the gravel layer, resulting in average removal rates of 44 to 47%. Greater PP removal was observed in the

summer than the winter. On the other hand, the wetland was a net exporter of soluble reactive phosphorus (average SRP removal rates of -28 to -41%). The wetland did remove soluble phosphorus during the growing season, but tended to export dilute levels (0.03 to 0.09 mg/l) through the winter months. The authors concluded that a key source of SRP was the unwashed gravel used to form the wetland bed, and predicted that performance would improve as this internal load was gradually washed out.

Reuter and his colleagues were generally encouraged by the monitoring results, and predicted greater efficiency when the wetland vegetation became fully established, and if it were regularly harvested. They consider gravel based wetlands as a useful stormwater practice for smaller development projects in the mountainous West where spring snowmelt runoff dominates the water-balance. It would seem that the gravel-based wetland bed is a concept that could be transferred to coastal areas where nitrogen control is often a management priority. A two-cell wetland design that includes a drained sand layer cell (to promote aerobic conditions) that feeds into a gravel-based wetland cell (to promote anaerobic conditions) might provide higher and more reliable removal of all the nitrogen forms. Further testing of gravel-based stormwater wetlands in more humid and benign climates are warranted.

—TRS

#### References

- Reuter, J. T. Djohan and C. Goldman. 1992. "The Use of Wetlands for Nutrient Removal From Surface Runoff in a Cold-Climate Region of California-Results From a Newly Constructed Wetland at Lake Tahoe." *Journal of Environmental Management*. 36: 35-53.
- Oberts, G. 1994. "Performance of Stormwater Ponds and Wetlands in Winter." *Watershed Protection Techniques*. 1(2): 64-68.

## Article 96

Technical Note #67 from *Watershed Protection Techniques*, 2(1): 304-306

# The StormTreat System: A New Technology for Treating Stormwater Runoff

by Scott W. Horsley, StormTreat Systems, Inc.

**F**requently, stormwater runoff from various land uses—such as roadways, lawns, gas stations—is combined in a drainage ditch or stormwater pipe, which ultimately discharges to receiving waters. However, the pollutants from these different sources are diverse in their composition and quantity. Stormwater management is best accomplished by techniques that treat each area within the watershed independently as opposed to the more conventional “big pipe” solution, where a large detention/pond is constructed at the bottom of a watershed in an attempt to catch and treat all of the stormwater generated by the watershed. The big pipe approach is land-intensive and costly.

### A Self-Contained, On-Site System

A new stormwater technology, StormTreat System, has been designed to capture and treat the first flush of runoff by being positioned high in the watershed and near the pollution sources. StormTreat incorporates sedimentation, filtration, and constructed wetlands into a modular, unitary 9.5-foot diameter structure. The number of units at each location is determined by the design storm, the size of the sub-drainage area, and the detention volume within the drainage infrastructure.

The StormTreat System is significantly smaller (usually five to 10% of the treated area) when compared with conventional stormwater ponds or wetlands. Where land costs are high or difficult site constraints exist, this size efficiency can represent significant cost savings. Discharge from the system is slow enough for either surface or groundwater discharge and so can be located in low-permeability soils with a high water table. StormTreat does not have standing water, which is common in conventional stormwater ponds and can be unsightly, unsafe, or encourage mosquito breeding (see article 100).

The StormTreat System consists of a series of 9.5-foot diameter recycled polyethylene tanks (Figure 1), resistant enough for brackish environments and self-anchored to compensate for high groundwater conditions. The tanks connect directly to existing drainage structures, most commonly the catch basins. While designed to intercept the first flush - typically half an inch of rain - the system can be sized to accommodate any size storm event. Any surplus runoff bypasses the system. Inlet pipes may be adapted to fit existing storm drainage pipes, paved swales, and other settings.

### Operation

The internal sedimentation chambers contain a series of bulkheads fitted with filter screens (Figure 2). A series of “skimmers” are also utilized to selectively decant the upper portions of the stormwater in the sedimentation basins, leaving behind the more turbid lower waters. After moving through these internal chambers, the partially treated stormwater passes into the surrounding constructed wetland through a series of slotted PVC pipes. The wetland is comprised of a sand and gravel substrate planted with cattails, bulrushes, and burreeds. An outlet control valve provides a five-day holding time within the system. The valve can be shut off in the event of a hazardous waste spill. It can also be closed at the end of the rainy season in arid zones to preserve the mini-wetlands. Unlike most constructed

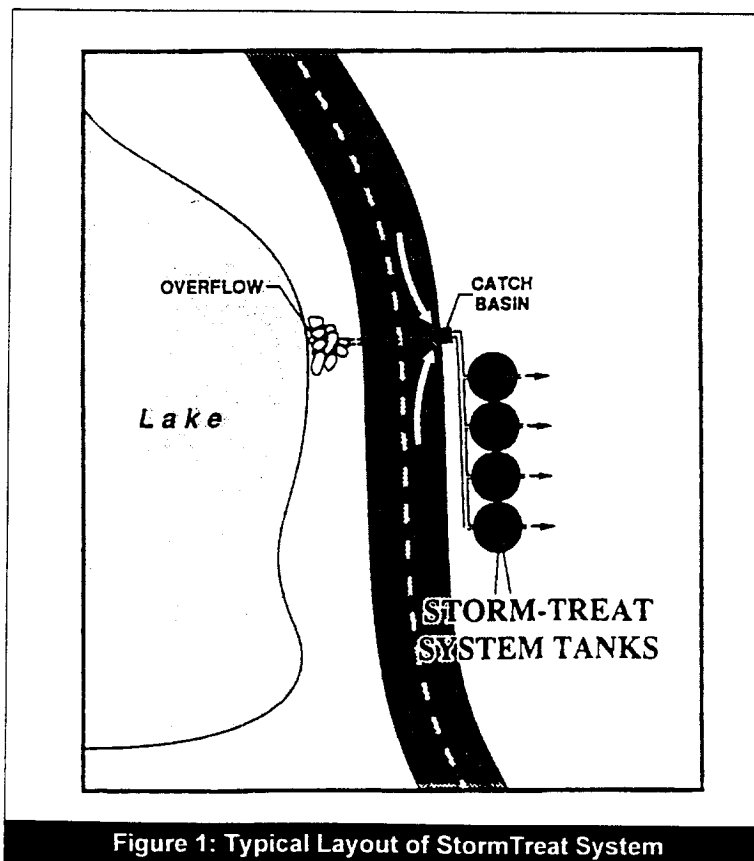

Figure 1: Typical Layout of StormTreat System

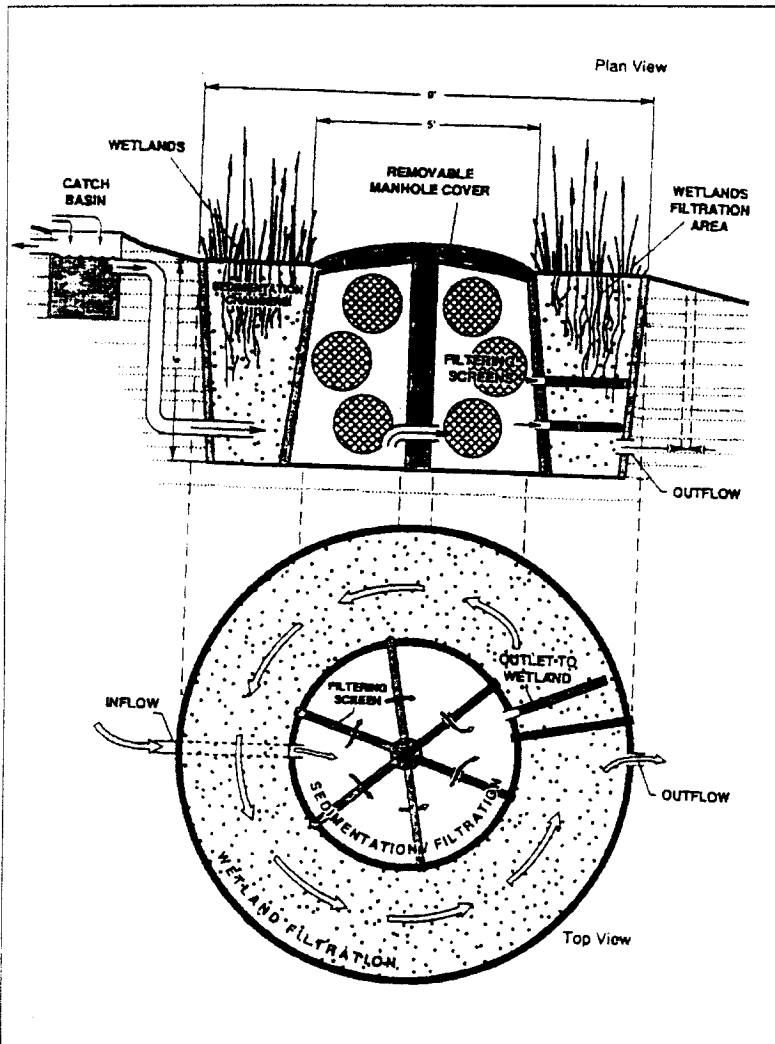

Figure 2: Cross-Section and Plan View of StormTreat System

wetlands, stormwater in the StormTreat System flows subsurface through the root zone of the constructed wetland, providing for greater pollutant removal.

### Maintenance

The StormTreat System requires minimal maintenance. The only regular maintenance requirement is sediment cleanout by suction pump once every three to five years, depending on local soil characteristics and catch basin maintenance practices. Annual inspections (and cleanings if necessary) of the screens and skimmers is also recommended. The cleaning of the screens is easily done by reaching into the manhole opening, unclipping the screens, and backwashing them with a garden hose. Inspection and cleaning of screens requires about 15 minutes per tank.

### Performance

To date, five storm events have been successfully sampled at the Kingston, MA installation (Table 1). First flush stormwater samples are taken at the entry point to the STS tanks by opening the manhole cover. Effluent samples are taken during the five days following the storm event. (Samples are obtained at the sampling ports where the effluent pipes discharge at ground surface.) The quality of the sampled effluent is compared with first flush runoff.

Removal of bacteria and pollutants is shown in Table 1. Testing results indicate that an average of 94% of the total coliform bacteria and 97% of the fecal coliform bacteria, 99% of the total suspended solids, and 90% of the total petroleum hydrocarbons are removed from the stormwater. Preliminary nutrient sampling suggests a removal rate of 44% for total dissolved nitrogen and 89% for total phosphorous. Higher nitrogen removal rates are expected during the growing

Table 1: Sampling Results From StormTreat System Treating 850-Foot Road Plus Parking Lot (Drainage Area 0.43 Acres Paved)

Pollutant	Stormwater influent	Treated discharge	Percentage removed (%)
Fecal coliform (no./100 ml)	690	20	97
Total suspended solids (mg/l)	93	1.3	99
Chemical oxygen demand (mg/l)	95	17	82
Total dissolved N ( $\mu\text{g/l}$ )	1,638	922	44
Total Petro HC (mg/l)	3.4	0.34	90
Lead ( $\mu\text{g/l}$ )	6.5	1.5	77
Chromium ( $\mu\text{g/l}$ )	60	1	98
Phosphorus ( $\mu\text{g/l}$ )	300	26.5	89
Zinc ( $\mu\text{g/l}$ )	590	58	90

### **StormTreat System**

- *Components:* sedimentation filters in combination with mini-wetlands in self-contained tanks
- *Size:* Each tank is 4 ft. high, 9.5 ft in diam, 5-10% of treatment area.
- *Capacity:* Number of tanks needed depends on storm design, impervious area, detention volume of accompanying collection basin.
- *Placement:* At site of runoff, e.g. in a series by roadside. Self-anchoring, suitable for coastal areas, adaptable to existing drainage pipes.

season when the wetland plants are more active. Removal rates for metals are as follows: lead, 77%; chromium, 98%; zinc, 90%.

### **Summary**

In many ways, the StormTreat System can be considered an adaptation of the gravel-based wetland technique. However, the promising pollutant-removal performance observed for the system needs to be discounted somewhat, since runoff greater than the first flush is bypassed around the unit, and receives no treatment.



**R0079948**

# Vegetated Rock Filter Treats Stormwater Pollutants in Florida

In recent years, a growing number of communities have employed rock or gravel-based media to grow emergent wetland plants to treat domestic wastewater. Known by many names, including rock-reed filters, vegetated submerged bed (VSB) wetlands, and shallow horizontal flow wetlands, they all apply the same basic technique (Figure 1). Wastewater is introduced into a shallow cell of rock or gravel in which wetland plants are rooted. Flow then travels slowly between the pore spaces in the rock, where it is subject to settling, algal and wetland uptake, and microbial breakdown. A recent technology assessment suggests that, when designed properly, VSB systems are a reliable and promising technique for reducing sediment, nutrient and organic carbon levels in wastewater (Reed, 1995).

In contrast, most stormwater wetlands are designed only to treat surface flows (and not subsurface flows). The question naturally arises whether the inclusion of rock or gravel cells could increase the pollutant removal performance of stormwater wetlands. Some preliminary answers have been recently reported by Egan and his colleagues (1995) in Central Florida. They designed and constructed an experimental "stormwater treatment train" to treat runoff from a 121-acre industrial subwatershed to protect a sensitive lake from eutrophication. The off-line system featured packed bed filter cells. Each packed bed filter cell was excavated into the soil, and had dimensions of 80 feet wide by 30 feet long and three feet deep. The bottom of each cell was sealed

with a plastic liner, and then filled with either crushed concrete or granite rock. Eight filter cells were planted with one or more of the following emergent wetland plant species: maidencane, giant bulrush, and fireflag. Two cells were not planted to serve as controls, i.e., to test the pollutant removal capability of the rock media itself.

The packed bed filters were but one component of a larger treatment train. The first component was an off-line storage facility designed to capture the first flush of runoff from the watershed. Diversion weirs shunted the water quality volume into a sedimentation chamber to provide pretreatment. Next, runoff was diverted into one of 10 packed filter beds cells. Flow into each cell was regulated by submersible pumps that distributed runoff evenly into each cell at one of three flow rates: 0.067, 0.13 and 0.27 cfs (or about 0.1 to 0.5 acre-feet of runoff treated per cell per day). The experimental system was instrumented with automated sampling monitors, and 15 simulated storms were withdrawn from the sedimentation chamber during the spring and summer.

The overall pollutant removal performance of the packed bed filter system is summarized in Table 1. It should be noted that the mass removal reported does not include any prior removal that may have occurred in the sedimentation chamber that supplied runoff to the filter cells. As can be seen, the removal rates for total suspended solids, total phosphorus, and fecal coliforms all approached or even exceeded 80%. In addition, the removal of both inorganic and organic nitrogen was

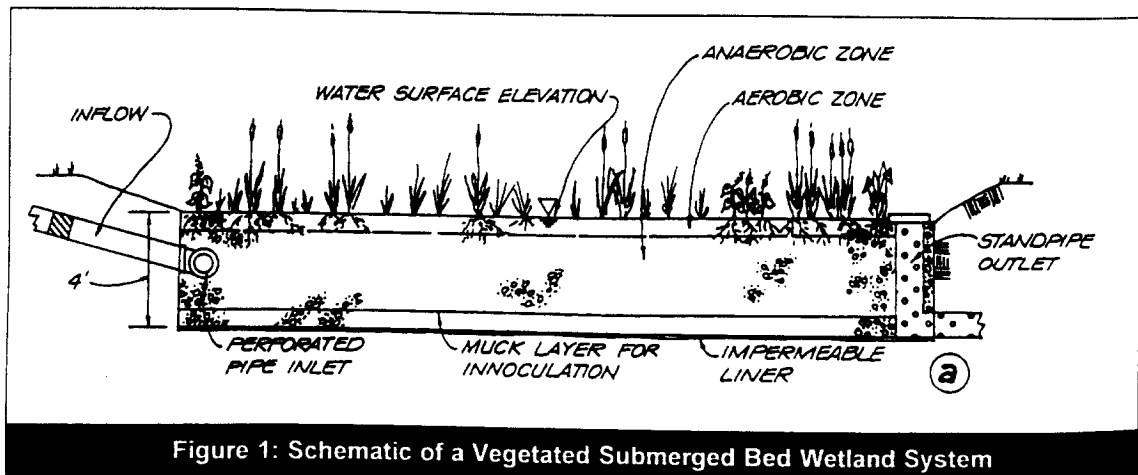

Figure 1: Schematic of a Vegetated Submerged Bed Wetland System



significant, ranging from 60 to 75%. In particular, the high removal of nitrate is unusual for many filtering systems, and may indicate that both nitrification and denitrification were occurring in the aerobic and anaerobic environments of the rock filter cells. Removal of other pollutants was moderate (organic carbon) to low (ortho-phosphorus and total dissolved solids). Removal of metals was also variable, with low to moderate removal for metals often found in soluble form (copper and chromium), and moderate to high removal for metals found primarily in particulate form (cadmium, lead and zinc). The metal removal analysis was somewhat complicated by the fact that many incoming metal concentrations were often at or below detection limits. In general, the pollutant removal performance of the packed bed filter was similar to those reported for sand and compost filtering systems, with the notable exception of consistently higher removal rates for inorganic nitrogen.

The 10 packed bed cells were arrayed in a manner that allowed Egan to examine the comparative influence of different rock media, wetland plants and flow rates on overall pollutant removal capability of the system. The statistical analysis revealed some interesting and surprising trends. For example, filter cells filled with recycled crushed concrete performed better than those that used granite rock. Egan speculated that the higher pH of concrete (7.5 versus 6.9) may have promoted greater epilithic algae and bacterial growth. In addition, the unplanted crushed concrete cells performed better than any other planted cells, suggesting that wetland vegetation had no discernible influence on pollutant removal. Emergent wetland plants did appear to slightly improve the performance of granite rock cells. The surprising conclusion, however, was that the rock surfaces themselves were more important in pollutant removal, by creating a large substrate area for growth of epilithic algae and microbes, reducing flow rates, and providing more contact surfaces. The same conclusion was reached by Reuter and his colleagues in their analysis of a sub-surface gravel-based wetland system in colder climates. Lastly, Egan and his colleagues found that best performance was achieved at the highest rate of flow, which tended to draw down water elevations in each cell by a third.

The experimental study implies that gravel or concrete filter cells could be an effective enhancement to surface stormwater wetlands designs, particularly in coastal regions where greater and more reliable nitrogen removal may be desired. In most cases, the basic design may need to be modified to allow gravity-driven flow rather than mechanical pumping. Where sufficient head is available, storm flows could be routed through a series of wetland or sand filter cells, and then into a sub-surface rock or gravel wetland cell. To prevent clogging or sediment deposition, the sub-surface cells should be

located off-line, and be fully protected by pretreatment cells.

-TRS

#### References

- Egan, T.J. S. Burroughs and T. Attaway. 1995. "Packed Bed Filter." *Proceedings of 4th Biennial Symposium on Stormwater Quality*. Southwest Florida Water Management District. Brookeville, FL. pp. 264-274.
- Reed, Sherwood. 1995. *Submerged Vegetated Bed Wetlands: A Technology Assessment*. Office of Water. U.S. EPA. Washington, DC.

Table 1: Average Mass Removal of the Packed Bed Filter System (Egan et al., 1995)

Parameter	Mass removal rate (%)
Total Suspended Solids	81
Total Dissolved Solids	8
Total Organic Carbon	38
Total Kjeldahl Nitrogen	63
Nitrate-Nitrogen	75
Total Nitrogen	63
Orthophosphate	14
Total Phosphorus	82
Cadmium	80
Chromium	38
Copper	21
Lead	73
Zinc	55
Fecal Coliforms	78

Note: 15 simulated storms



R0079950

## Article 98

Technical Note #23 from *Watershed Protection Techniques*, 1(2): 81-82

# Practical Tips for Establishing Freshwater Wetlands

No shortage of books and manuals exist to design freshwater wetlands for mitigation, restoration or stormwater treatment. A recent series of articles by Garbisch and others, however, suggest that successful establishment of freshwater wetlands often hinges on writing practical and thorough construction specifications for the contractor who implements the design. Lack of attention to these important details can lead to serious problems in establishing a dense and diverse freshwater wetland.

Ed Garbisch founded the nonprofit corporation **Environmental Concern (EC)** in 1972 to educate, research, develop, and apply technology for the restoration and construction of wetlands. Over this period, EC has been involved in hundreds of tidal and non-tidal wetland establishment projects and has gained a great deal of experience in wetland propagation and creation techniques. Some of the practical lessons they have

learned on how to construct successful wetlands are summarized in Table 1.

Matching the design hydrology of the planned wetland with the appropriate wetland plant species is perhaps the most critical task in the design of diverse pondscares. However, many wetland construction drawings fail to even show the design hydrology on the plan. Without a good understanding of the future water surface elevations and the frequency of inundation it is nearly impossible to make the right match. Therefore, it is important to clearly show design hydrology on all construction drawings (plan view and cross section).

Another frequently encountered problem is that while the planting plan may contain an extensive wetland plant list, most of the species may not be available in quantity from local wetland nurseries at the time of construction. As a consequence, plant species are substituted at the last minute that may not meet the

**Table 1: Useful Construction Specifications for Freshwater Wetlands (Garbisch, 1993, 1994)**

1. Always clearly specify the proposed wetland hydrology on construction plans and drawings to ensure that proper wetland plants are selected. Be wary of wetland projects that only rely on groundwater for water supply.
2. Consider procuring wetland plants through growing contracts with wetland nurseries. These contracts ensure that the desired species and quantities of wetland plants will be available to implement the planting plan.
3. Use care before automatically requiring topsoil amendments to prepare the substrate for planned wetlands. Topsoiling may not always be needed, can be expensive and may introduce undesirable species from the seedbank.
4. Although it is very important to quickly stabilize disturbed upland areas during construction, avoid specifying the use of Tall Fescue for this purpose, because of its allelopathic character.
5. Be careful when specifying hydroseeding to establish stormwater and other types of wetlands without strong confidence that seeds will germinate and root in the substrate before the site is inundated. Otherwise, both mulch and seeds will float away or be unevenly distributed through the marsh.
6. If seeding is to be used as the key propagation method to establish the wetland, be sure to specify the quantity of pure live seed needed, the commercial source of seed, seeding technique, filler, and window and other key aspects leading to a successful result.
7. Clearly specify watering requirements during the first growing season for seasonally or temporarily inundated wetland areas. Drought conditions can severely reduce growth and survivorship for these wetlands without initial watering by truck or by a shallow aquifer well.

original intent of the wetland plan. A new approach has been developed to ensure that the species and quantities of wetland plants are available at the time of construction.

This approach is termed *contract growing*. It involves executing an advance contract with a wetland nursery to grow and deliver a specified number and species of plants at a future date. An up-front deposit of 20 to 30% is normally required prior to growing. While contract growing means more planning and logistics, the practice does provide a better guarantee that the planned and most desirable wetland plant species will be available when needed.

Garbisch also questions the common specification to topsoil the surface of created herbaceous wetlands prior to planting. Topsoiling can be expensive, and may not always be needed at most sites. This is due to the fact that herbaceous wetland plants typically produce a great deal of below-ground organic matter and quickly dominate the composition of the substrate within a few years. Garbisch does suggest topsoiling in clay, rock, or pyritic soils and topsoiling or soil amendment for forested or scrub shrub wetlands. But generally, soil tests should be performed before recommending topsoil at a particular site.

Most wetland plans devote a great deal of attention to the selection of wetland plant species, but give relatively little thought to the ground covers used to vegetate disturbed areas around the pond or wetland. Many plans simply specify that these areas be stabilized through hydroseeding of KY-31 Tall Fescue (*Festuca arundinacea*). Fescue has been widely specified for years for erosion control during and after construction. It does an admirable job of quickly establishing a dense turf cover. This cool season bunch grass also tolerates a wide range of moisture conditions and can invade many areas of the site.

Burchick (1993) questions the wisdom of specifying Tall Fescue as a ground cover around wetlands and ponds. He argues that Fescue frequently displaces native grass and meadow species, out-competes natural or planted tree seedlings, and can even invade portions of the wetland. Fescue is a tough competitor partly due to its allelopathic characteristics. It secretes organic acids that can impair the germination of native species. Consequently, Burchick recommends that less aggressive cool season grasses be utilized for erosion control purposes around pond and wetland areas.

Direct seeding is often the most economical technique to establish wetlands. Garbisch cautions that construction specifications should be very tight if direct seeding is called for. For example, many wetland seed mixes have relatively low purity and germination rates. Consequently, Garbisch observes that if a pound of pure live seed (pls) is needed to establish a ground cover per unit area, and it has a 10% germination rate and

50% purity, then some 20 pounds will actually need to be broadcast to achieve the desired coverage. Consequently, it is recommended to express direct seeding rates in terms of pure live seed. The specifications should either require that the source(s) of the seed be indicated, or require that they be field collected and tested for purity and germination rate.

Of equal importance are the seeding *window* and *filler*. The window is the optimal seasons and dates for a successful result. The filler represents the sand dilution needed for small seeds to ensure they are uniformly distributed over the planting area. Seeding specifications should also clearly state the technique and implements for the seeding operation, and whether this operation will be done in the wet or the dry. Hydroseeding of wetlands should be avoided unless the contractor has confidence that the seeds will germinate and root before the next runoff event. Otherwise, the mulch, tack and seeds will float away or become unevenly distributed.

The establishment of a dense and diverse wetland is the joint product of the design engineer, landscape architect, wetland nursery, and planting contractor. Thoughtful and clear construction specifications help assure that each individual performs his or her role well.

—TRS

#### References

- Burchick, M. 1993. "The Problems With Tall Fescue in Environmental Restoration." *Wetland Journal*. 5(2):16.
- Garbisch, E. 1993. "The Need to Topsoil With Mineral Loam Soils in Planned Wetland Projects." *Wetland Journal* 5(2): 18.
- Garbisch, E. 1994. "The Do's and Don'ts of Wetland Planning." *Wetland Journal*. 6(1): 16-17.

# Broad-Leaf Arrowhead: A Workhorse of the Wetland

The broad-leaf arrowhead (*Sagittaria latifolia*) is a native North American wetland plant found in southern Canada and much of the United States. Many practitioners have found it especially useful for wetland enhancement, restoration, and creation projects because of several desirable characteristics. However, Marburger (1993) points out there is still much to be learned about its ecology and physiology before routinely investing in large scale planting and management schemes.

The plant is identified by its rosettes of arrowhead-shaped leaves. Flowers are white with three petals and arranged in whorls around a long stalk. Its most distinctive feature is the starchy tuber produced from the rhizomes. This phenomenon gives rise to its common name of *duck potato*. This "potato" portion of the plant is consumed by muskrats, porcupines, geese, and other animals. Native Americans and European settlers also used the tuber as a food source.

While its days as human food have long since past, other beneficial characteristics of broad-leaf arrowhead have propelled it into the field of wetland restoration. Special characteristics include the following.

1. **Adaptation to a wide range of conditions.** The plant persists under stabilized water levels of less than 50 cm and few drawdowns and survives in pHs from 5.9 to 8.8. It has been found in highly calcareous water and in a variety of soil types including sandy loams and silty clays. While it can withstand turbid conditions, it does not tolerate severe sediment deposition.
2. **Nutrient uptake.** Arrowhead rapidly takes up phosphorus from the sediments and retains it in its tissue. In one South Carolina study it had the highest leaf tissue composition of phosphorus of 17 wetland plants analyzed (Boyd, 1970). For this reason arrowhead is often selected for use in municipal and domestic wastewater treatment systems, constructed wetlands, and for stormwater runoff treatment.

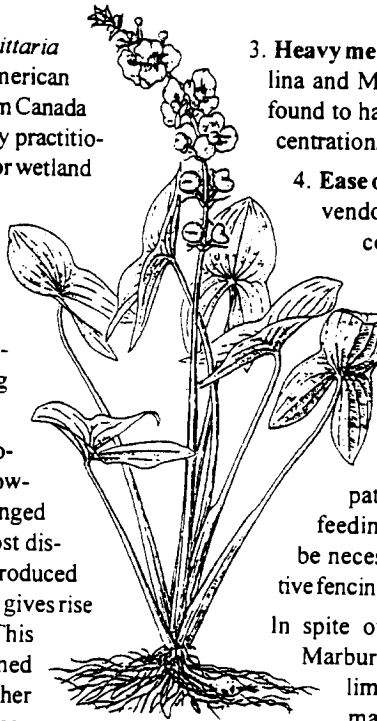

Adapted from Fassett, 1960

3. **Heavy metal uptake.** In surveys in South Carolina and Michigan, broad-leaf arrowhead was found to have the highest leaf dry weight concentrations of several metals.

4. **Ease of plant propagation.** Wetland plant vendors can supply achenes, tubers, and container-grown plants. Tubers are generally preferred because they require less site preparation. Plants are more costly, but survive a wider range of initial conditions.

5. **Resistance to disease and damage.** There are few reports of population reductions due to pathogens, insect pests, and animal feeding. In some limited situations, it may be necessary to enclose areas with protective fencing to keep out muskrats and waterfowl.

In spite of many apparent field successes, Marburger points out there exists only a limited database on the installation and management of the broad-leaf arrowhead, especially for large-scale applications. Before incorporating the

arrowhead in a wetland design, the practitioner needs to work with plant vendor to identify the following:

- If the environmental factors at the site are more favorable for germinating/growing achenes, tubers, or seedlings
- If environmental factors are right for sustaining a mature population of arrowheads
- If pathogens, animal herbivory, and/or other plant species are likely to impact the plant

### References

- JS
- Boyd, C.E. 1970. "Chemical Analyses of Some Vascular Aquatic Plants." *Archiven für Hydrobiologie* 67:78-85.
- Fassett, N.C. 1960. *A Manual of Aquatic Plants*. The U. of Wisconsin Press, 405 pp.
- Marburger, J.E., 1993. "Biology and Management of *Sagittaria latifolia* Willd. (Broad-leaf Arrowhead) for Wetland Restoration and Creation." *Restoration Ecology* 1(4) 248-257.

# Mosquitos in Constructed Wetlands: A Management Bugaboo?

Urban planners considering constructed wetlands for stormwater treatment might be concerned that mosquitos could become a major nuisance. Some observations in the field indicate that mosquitos are not a problem in constructed wetlands (Adams, 1983; Bennett, 1983). In general, functioning stormwater wetlands are less likely to produce mosquitos than are nutrient-laden secondary sewage and agricultural wastewater ponds or ponds that do not have frequent turnover. Even so, strong preconceptions exist, and building a wetland without first gauging public opinion could result in a major public relations headache. Those involved in the decision to build a wetland and the wetland designer can familiarize themselves with the breeding requirements of prevalent mosquito species to determine whether they feed on humans or carry disease and the likelihood that a wetland will be a high producer of mosquitos. Public opinion surveys and good information dispersal are important to avoid setbacks or negative impressions of wetlands and stormwater practices. Preventive measures can be incorporated in the site selection and design. In general, the basic design and maintenance of a good stormwater pond deters mosquito production (Table 1). If, indeed, mosquitos emerge, various biological controls can be used to subdue larval and adult populations.

An anti-mosquito strategy is as follows:

1. Assess the probable mosquito nuisance level of the area. Inform the public of the differences between stormwater and wastewater treatment.
2. After obvious high-risk sites have been ruled out (the local riding stable!) and there is still a moderate risk, modify the wetland design (e.g., maintenance of base flow, choice of vegetation) to deter mosquito breeding.
3. Choose and implement appropriate controls (Table 2) and monitor production levels.

*Consult Biologists Familiar With the Locality at Each Stage*

Some form of public involvement could be incorporated into the technical process. It cannot be assumed that residents will accept different designs equally. It might be worth considering inviting interested residents to participate in the planning well

before designs are finalized and resources committed to the project.

### Mosquito Risk

Where and when are mosquitos a concern? Wherever there is standing water, there may be mosquitos. Depending on the species, eggs are laid directly in standing water or in dry cavities (ground depressions, old tires) that later receive water. The larvae feed on algae and organic particles and take in oxygen by floating at the surface. Larvae develop into pupae, which emerge from the water as winged adults. The females of most species feed on the blood of animals although not all feed on humans. Many species of *Culex* do indeed feed on humans and these are the major nuisance species of North America. Some species of *Culex* carry encephalitis. Only species of *Anopheles* may potentially carry malaria and while there are such mosquitos in North America, the disease itself has not recently occurred here.

Mosquito production is sensitive to water level fluctuations. For the majority of species, production

**Table 1: How Well-Designed Stormwater Wetlands Deter Mosquito Production**

Mosquito breeding requirements	Stormwater pond design
<ul style="list-style-type: none"> <li>■ Shallow, stagnant water; anaerobic condition</li> <li>■ Egg rafts of permanent-pool species float on the water</li> </ul>	<ul style="list-style-type: none"> <li>■ In a well-constructed and maintained stormwater pond the water is kept moving; residence time is only a few days.</li> </ul>
<ul style="list-style-type: none"> <li>■ Adult females choose environments of high nutrition (anaerobic, high nutrients and bacteria) in which to lay their eggs.</li> </ul>	<ul style="list-style-type: none"> <li>■ Urban stormwater ponds are in non-agricultural settings and do not have high nutrient loads or animal waste.</li> </ul>
<ul style="list-style-type: none"> <li>■ Temporary-pool species require periodic drying (as in containers, puddles, tidal marshes)</li> </ul>	<ul style="list-style-type: none"> <li>■ Well-designed on-line systems are not expected to dry out.</li> </ul>

**R0079954**



increases with duration of standing water. However, there is an important exception in the case of "temporary pool" mosquitos. Impounding and flooding marshes is a way of controlling mosquitos in mainly coastal areas, where the prevalent nuisance species is one that depends on dry periods for egg development. In some localities, this approach could backfire if permanent-pool mosquitos also occur in the area where temporary-pool species are being controlled. One could inadvertently trade one nuisance species for another! It is important to know which species one is dealing with and what their breeding requirements are before implementing controls.

Being bit by a mosquito near a wetland does not necessarily mean that the mosquito came from the wetland. Female freshwater mosquitos range over half a mile (WRRI, 1989). Saltwater marsh species may range as far as 40 miles away from the site of emergence and be a nuisance in urban centers (R. Wolfe, personal communication). Therefore, mosquitos in an urban area could be coming from a number of sources, not necessarily the nearest wetland.

#### Designs for Deterrence

Which wetland designs contribute to and which deter mosquito production? Some factors that make wetlands good water treatment devices also make them more likely to be breeding areas for mosquitos:

- Dense vegetation is desired to better filter incoming water, stabilize the pond bottom, provide microbe substrate, and take up excess nutrients. Unfortunately, dense submerged vegetation can be correlated with high mosquito larvae production (WRRI, 1989), probably because the foliage provides refuge from predators and particles of plant detritus are food for larvae. Trees could be planted to shade out herbaceous aquatics but this would be counterproductive for water treatment.
- Low oxygen content and the presence of partially decomposed organic matter makes wetlands good immobilizers of trace metals. Mosquito larvae also thrive in these conditions.
- High surface area-to-volume ratio of the pond is generally recommended to achieve sheetflow and maximize the area of substrate for pollutant adsorption. Unfortunately, these large areas of shallow water are conducive to mosquito production. Deeper and steep-sided ponds will probably produce fewer mosquitos.
- A gradual bank slope increases vigor, diversity, and efficacy of the vegetation and lessens erosion (article 92). This design might also lead to higher mosquito production.

Certainly these basic design principles need not be abandoned, so long as it is understood that post-construction mosquito controls might be needed.

Some design considerations for mosquito deterrence include the following:

- Get an idea of future nutrient load on the wetland—is any septage or agricultural and animal waste likely? Sites of high nutrient load should be avoided. This is not likely to be a problem in developed settings.
- Attempting to avoid standing water altogether by building wetlands with flow-through gravel bottoms or that operate intermittently is probably unnecessary. Keeping a wetland dry is counterproductive to stormwater treatment processes (for example, the microbial activity in the muck layer). In addition, the degree of water level control appropriate in wastewater treatment or impoundments requires more supervision than can usually be given to a stormwater practice. Wastewater wetlands are built for a different purpose than are stormwater wetlands and function under different circumstances; therefore, their design and operation should not be copied blindly.
- Choose emergent vegetation with minimal submerged growth—dense submerged foliage provides refuge for the larvae and interferes with sampling and control.
- Cover open canals where feasible to cut down on standing water open to the sun; replace open troughs with closed distributor pipes (Tennessee, 1993).
- A properly laid-down parallel pipe system (article 150) will drain away and shouldn't cause any problems.
- Construct stormwater ponds on-line. Keep inflows and outflows clear of debris to maintain base flow.

#### Evaluation of Controls

##### *Bacteria*

The bacterium *Bacillus thuringiensis israelensis* (Bti) is a common insecticidal control of mosquitos and flies. It is widely available in briquet, powder, or liquid form. Commercial Bti is considered safe enough to add to drinking water (WRRI, 1989). It is active against most mosquitos, but less so against *Anophelens*. It is also toxic to many flies. There appears to be no evidence as yet that it is harmful to "desired" insects. Bti does not appear to interfere with the activity of larvae-eating fish (Mian, 1986). In addition, the presence of nitrates and phosphates does not

Table 2: Comparison of Mosquito Controls

Control	Efficacy	Availability
<i>Biological controls</i>		
<i>Mesocyclops</i> , a copepod	50-90% larvae consumed every few days	Laboratory reared, not easily obtained
Fish	Live-hatchers tend to do better than egg-layers; native spp. should be chosen, restocking not necessary except after severe winters or in shallow ponds	Non-natives may be prohibited in your areas. State Dept. Natural Resources or Mosquito Control often raise stocks of native fish
Pupfish ( <i>Cyprinodon</i> )	Egg-layer, good survival in unpolluted water but sensitive to wastewater	Most restricted to desert streams/springs in Southwest, some endangered.
Guppy ( <i>Poecilia reticulata</i> )	Prolific live-hatchers, high efficacy, sensitive to pH but tolerant of wide range of temperatures and dissolved oxygen	Non-native
Mosquitofish ( <i>Gambusia spp.</i> )	Live-hatching, does well in non-polluted waters	Wide-ranging native and introduced spp. in US, E. coast, S.E., Missisipi and Colorado R. basins
Killifish ( <i>Fungilis spp.</i> )	Voracious, very successful in MD and DE coastal programs	Several native spp., hardy overwinterer
<i>Larvicides</i>		
Cyromazine, methoprene (insect hormones)	One-time application good for 30+ days, application time should correspond with larval development	Several US distributors
Organophosphates (e.g. Abate)	Broad spectrum toxin, lethal for many invertebrates	Several US distributors
<i>Bacillus sphaericus</i>	Efficacy depends on ingestion by larvae, not as effective as Bti against non-Culex spp.	Product in development, available in some states, not nationwide
<i>Bacillus thuringiensis israeliensis</i> (Bti)	Highly effective if applied at correct time, efficacy depends on ingestion by larvae, high turbidity or suspended solids interfere with ingestion	Widely used in various forms, several distributors in US
References: Mian, 1986; Castelberry, 1990; Toyama, 1986; Cohen, 1986; Tennessen, 1993; Jones, 1990; Ali, 1989		



interfere with uptake of *Bacillus* larvicides, as is the case with organophosphates (Tennessee, 1993). The agent is applied as pellets, dust, or slug injection. Bti becomes active upon ingestion by the larvae. It loses its efficacy as the larvae age or as turbidity increases. A newer bacterial strain, *Bacillus sphaericus*, showed longer activity than Bti in one study but was not as effective as Bti against species other than *Culex* (WRRJ, 1989). *B. sphaericus* is approved by the U.S. EPA but state registration is pending. At least one American company is developing the product. Tennessee (1993) recommends weekly treatments with Bti before sampling reaches 0.5 larvae/dipper, blower application for small wetlands, and slug injection for large cells.

#### *Chemical Larvicides*

Unlike *Bacillus* larvicides, organophosphate larvicides, such as temephos, are non-specific—they kill whatever animal receives a lethal dose. This means that the dose required to kill the mosquito larvae in a pond could do away with many other invertebrates in the wetland and pose a threat to downstream habitats. If these chemical larvicides are overapplied, the dose may be high enough to be a risk to the health of other animals and an irritant to people. This makes organophosphates inappropriate control agents in populated areas. Some non-phosphitic chemicals that are used as larvicides are methoprene, an insect hormone mimic, and cyromazine, an insect growth regulator which purportedly affects only flies and mosquitoes. Cyromazine was found effective in one study of a drainage ditch. A one-time application of cyromazine (0.5 g active ingred./m<sup>3</sup>), prevented pupation and emergence for about forty days in a drainage ditch (Cohen, 1986).

The chemical Sevin (carbaryl) is toxic to humans and animals and should not be used.

#### *Insect-Eating Fish*

The best fish for mosquito control are those species that reproduce quickly and have a wide tolerance of environmental conditions. The more fish in the pond, the fewer mosquitos that emerge. Castleberry (1990) compared three species - pupfish (*Cyprinodon nevadensis amargosae*), mosquitofish (*Gambusia affinis*), and guppies (*Poecilia reticulata*) - in tanks planted with pondweed and containing *Culex* larvae. Guppies became well established, and tanks containing these fish produced the fewest mosquitos. Mosquitofish placed second and pupfish last. The trouble with pupfish may be that they are egg-laying and the eggs have a narrow environmental tolerance. The live-hatchers did better. Mian *et al.* (1986) observed high survival rates for both the guppy and a different species of pupfish (*Cyprinodon macularius*). In another study, guppies began to die when pH fell

below 5.5 (Toyama, 1989), indicating that acidity may be more of a factor than dissolved oxygen for fish survival. This would indicate that fish may not be the best control choice at industrial sites or in waters known to be highly acidic. The natural ranges of these fish should be noted: guppies are non-native; pupfish are native to desert springs and streams of the western US; species of *Gambusia* have a wide range in the US. Native minnows and killifish have done a good job in keeping down mosquitos in Maryland and Delaware and overwinter successfully if ponds are deep enough (at least three feet) (Wolfe, Lesser, personal communication). State DNR personnel should be contacted before any fish are introduced into wetlands.

#### *Copepods*

Copepods, tiny swimming crustaceans, feed on mosquito larvae and show some promise. Mosquito larvae consumption by a copepod was compared along with the performance of pupfish and guppies (Mian, 1986). The copepod was not adversely affected by effluent in the water and consumed between 50 and 90% of the mosquito larvae in a 24 to 72 hour period, whether there was other suitable food or not.

#### *Other Animals*

Putting up nest boxes to make the site more attractive to martins, swallows, etc., wouldn't hurt in reducing number of adult mosquitos. Tadpoles can be introduced into ponds to increase the frog population but it is unlikely that they are as effective as some of the larvae-eating fish.

#### *Ecological Impacts of Control*

Mosquito control techniques other than actual draining or flooding of marshes are fairly recent. The research has focussed on the efficacy of the new techniques and little is known about the ecological side effects. *Bacillus* larvicides supposedly act only on flies and mosquitos. Larvicides tend to be tested in the lab or in the field for target species only (mosquitos). Aside from cursory observation of aquatic invertebrate abundance, no one seems to know what the effects on the whole invertebrate community are. As for the impounding of tidal marshes to control temporary pool species, there are conflicting observations on the impacts to fish diversity and plant productivity depending on the location and native species.

#### **Conclusion**

It would seem then, from both an ecological and management standpoint, that designing a wetland that optimizes surface area and plant growth without excessive mosquito production is a more efficient approach than costly manipulations after the fact. It would also seem that, where necessary, biological



rather than chemical control of mosquitos is preferred, since the biological controls specifically target mosquito larvae and are harmless to humans, unlike many chemicals even at standard doses. As more comparisons are made between stormwater and wastewater wetlands and also reference natural wetlands, it could well be discovered that mosquito control in stormwater wetlands is rarely warranted. —JMC

#### References

- Adams, L. W. 1983. *Urban Wetlands for Stormwater Control and Wildlife Enhancement: Analysis and Evaluation*. Columbia, MD: Urban Wildlife Research Center
- Ali, A., M. S. Weaver, and E. Cotsenmoyer 1989. "Effectiveness of *Bacillus thuringiensis serovar israelensis* (Vectobac 12AS) and *Bacillus sphaericus* 2362 (ABG-6232) Against *Culex* spp. Mosquitoes in a Dairy Lagoon in Central Florida." *Fla. Entomol.* 72(4): Abstract.
- Bennett, G. W. 1983. *Management of Lakes and Ponds* (2nd ed.) Malabar, FL: Krieger Publishing Co.
- Casteleberry, D. T., and J. J. Cech, Jr. 1990. "Mosquito Control in Wastewater: A Controlled and Quantitative Comparison of Pupfish (*Cyprinodon nevadensis amargosae*), Mosquitofish (*Gambusia affinis*) and Guppies (*Poecilia reticulata*) in Sago Pondweed Marshes." *J. Am. Mosquito Control Assoc.* 6(2): 223-228.
- Cohen, J. 1986. "Observations on the Effect of Cyromazine on Inhibition of Larval Mosquito Development in Diluted Wastewater." *J. Am. Mosquito Control Assoc.* 2(3): 367-368.
- Jones, J. W., A. A. Weathersbee, III, P. Efrid, and M. V. Meisch 1990. "Evaluation of *Bacillus sphaericus* 2362 Against *Culex quinquefasciatus* in Septic Ditches." *J. Am. Mosquito Control Assoc.* 6(3): Abstract.
- Lasalle 1974. *Effects of Salt Marsh Impoundments on Mosquito Populations*. WRRR rep. 92 and 102
- Lesser, C. 1995. Personal communication. Maryland Department of Agriculture, Division of Mosquito Control.
- Matanmi, B. A., B. A. Federici, and M. S. Mulli. 1990. "Fate and Persistence of *Bacillus sphaericus* Used as a Mosquito Larvicide in Dairy Wastewater Lagoons." *J. Am. Mosquito Control Assoc.* 6(3): Abstract.
- Mian, L. S. M. S. Mulla, and B. A. Wilson. 1986. "Studies of Potential Biological Control Agents of Immature Mosquitoes in Sewage Wastewater in Southern California." *J. Am. Mosquito Control Assoc.* 2(3): 329-335.
- Tennessee, K. J. 1993. "Production and Suppression of Mosquitoes in Constructed Wetlands." *Constructed Wetlands for Water Quality Improvement*, ed. G. A. Moshiri, Boca Raton: CRC/Lewis.
- Toyama, G. M. 1986. "Low pH as the Limiting Factor for Survival of the Mosquito Larvivorous Fish, *Poecilia reticulatas*, in Impounded Sugar Mill Wastewater." *Proc. Hawaii Entomol. Soc.* 26: Abstract.
- Water Resources Research Institute. 1989. *Report No. 247: Proceedings of Workshop on Management of Aquatic Weeds and Mosquitoes in Impoundments*. March 14-15, 1989 UNC Charlotte
- Wolfe, R. 1995 Personal communication. Delaware Department of Environmental Control, Mosquito Control Division



R0079959

# Infiltration

R0079960



# Failure Rates of Infiltration Practices Assessed in Maryland

**H**ow long do infiltration practices operate effectively after they are installed? The answer, according to a field survey by Galli (1993), is not very long. He inspected over 60 infiltration trenches and basins constructed in the coastal plain and piedmont of Maryland during both dry and wet weather.

The structures ranged in age from six months to six years. They were all located within Prince George's County, which has been a regional leader in infiltration design standards, plan review, and construction inspection.

Galli found that less than half of the nearly 50 infiltration trenches he surveyed were working as designed. Furthermore, the longevity of trenches declined over time — less than one-third still functioned after five years.

Most trenches served smaller commercial developments of two acres or less. The trenches all incorporated some mechanism for runoff pretreatment, either in the form of a sump pit (N=31) or a grass filter strip (N=7) (Figure 1).

In addition, the majority of trenches had observation wells, bottom sand layers, and filter fabric protection on the trench walls and one foot below the trench surface. Soil borings were taken at 85% of the sites to confirm the underlying soil properties. As with many stormwater practices, the trenches were not maintained after their construction. The major performance problems encountered in the field are itemized in Table 1.

The effectiveness of the protective 25-foot grass filter strips was marginal. All of the filter strips experienced erosion, spotty vegetative cover, or short-circuiting within two years after construction. Sump pits, on the other hand, appeared to be a more effective pretreatment technique. The median volume of trapped sediment in the sump was about 10 cubic feet, and was composed of coarse inorganic sediments (55%), fine sand and silt (25%), and coarse organic matter and litter (20%).

Although the volume of trapped sediments in sump pits clearly indicates the critical need for pretreatment, the sediment volume did not increase with age. This finding implies that unless sump pits are regularly cleaned out, it is likely that the trapped sediments will be resuspended and transported inside the trench.

Figure 1: Schematic of Sump Pit Used to Pretreat Runoff Before Infiltration (Galli, 1993)

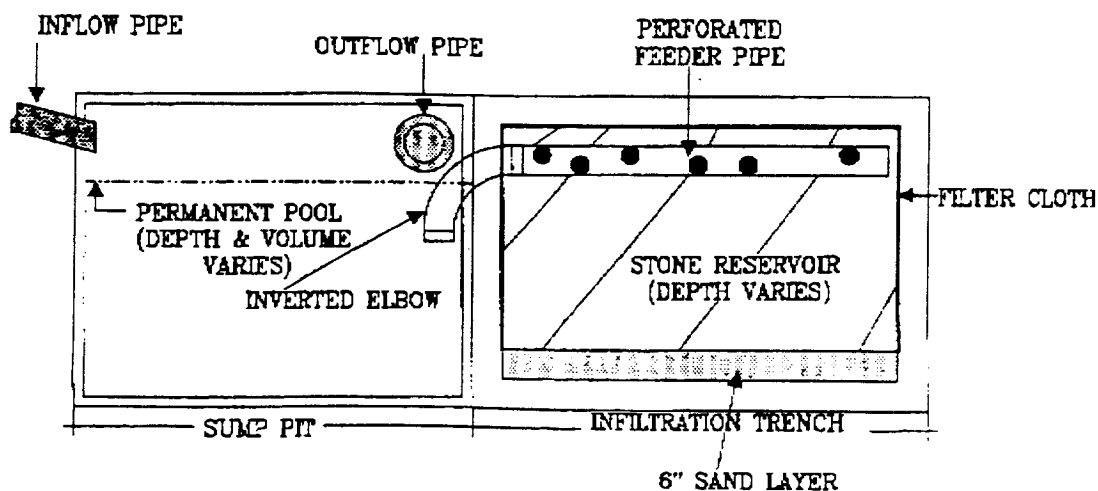

R0079962

**Table 1: Maintenance Problems Associated With Infiltration Trenches (Galli, 1993)**

Maintenance Problem	Sump Pit Trenches (%)	Filter Strip Trenches (%)
Slow infiltration rate	39	42
Excessive Sediment Buildup	67	32
Poor Flow Pattern	6	29
No Observation Well	16	0
Feeder Pipe Missing	29	NA
Poor Vegetative Cover	NA	71
Surface Filter Fabric Clogged	NA	29
Requires Major Rehabilitation	65	71
Working as Designed	48	43

The underlying cause for the failure of the trenches was attributed to three factors. First, a number of trenches were constructed in questionable soils, while others may have been constructed too close to the water table. Second, many trenches were prematurely contaminated by sediments during or shortly after their construction. Lastly, trenches were gradually clogging due to inadequate pretreatment of runoff.

Twelve infiltration basins were sampled. Most had relatively small surface areas (0.01 to 0.20 acres) and corresponding drainage areas (mean = 1.8 acres). All 12 of the infiltration basins clogged within two years of construction. The basins exhibited surface ponding in dry weather (mean depth of one foot), saturated soils, and a vigorous cover of wetland plants. Essentially, the infiltration basins quickly evolved into pocket wetlands. Although none of the basins were infiltrating runoff as originally designed, 60% provided at least partial pollutant removal for some fraction of runoff (either through very slow infiltration or by providing some dead storage up to the crest of the riser).

The complete failure of the basins to infiltrate runoff was due to a series of interrelated problems. These included compaction of soil during construction, further compaction of soils by the mass of ponded water after construction, large sediment inputs (very few basins had any kind of pretreatment to trap coarse sediments before they entered the basin), poor vegetative cover on the basin floor, and sealing of the basin floor by algal mats.

Galli provides several recommendations for increasing the longevity of infiltration trenches. They include (1) better geotechnical and groundwater investigations, (2) standardization of observation well caps, (3) better specification of clean stone materials for the reservoir, and (4) regular cleanout of sump pits.

Perhaps with more effective pretreatment, maximum ponding depths, direct stone inlets into deeper soil layers, and back-up underdrains, infiltration basins could achieve greater longevity in the field. However, in the final analysis, communities will need to carefully review their ability to provide or enforce regular maintenance activity if the longevity of infiltration practices is to be measurably improved.

—TRS

**Reference**

Galli, J. 1993. *Analysis of Urban BMP Performance and Longevity in Prince George's County, Maryland*. Metropolitan Washington Council of Governments, 202 pp.

# Longevity of Infiltration Basins Assessed in Puget Sound

by Karin Hilding, Hammond, Collier, Wade, and Livingston Associates, Seattle, WA

**R**ecent performance studies from the East Coast suggest that infiltration basins have a very short useful life before they clog. Failure rates of 50% and 100% have been reported. However, these studies were conducted in the mid-Atlantic region, where soils can often have marginal infiltration capacity (from 0.5 to 1.0 inch/hour) and, perhaps more importantly, have a high clay content. Other regions of the country are underlain by sandy or gravelly soils of much greater infiltration capacity. Will infiltration basins work better in these environments?

To test this hypothesis, 23 infiltration basins were surveyed in the Puget Sound Basin of the Pacific Northwest. The basins were designed for stormwater quantity control and not for water quality purposes. Detailed textural analysis and single ring infiltrometer tests were conducted on a subset of eight basins. In addition, stormwater managers and public works officials were interviewed to obtain a general assessment of how infiltration basins performed over time.

A number of factors would seem to promote better longevity in the Puget Sound area. First, basin soils had exceptionally high infiltration rates, ranging from 1.1 to 36 inches/hour (coarse gravelly sandy loams and fine sandy loams). Second, clay content of the underlying soils was never greater than 13% in any basin tested. Lastly, inspections and corrective maintenance had been regularly conducted at many of the basins, at least in the last few years.

On the other hand, most of the basins were constructed prior to the most recent infiltration basin design guidelines, issued by the Washington Department of Ecology (see Table 1). Consequently, few of the basins had effective pretreatment features, such as biofilters, forebays, or filter berms, that are now required on new infiltration basins.

The results of the survey indicate that while a majority of the infiltration basins were still working properly after 10 years, many had encountered problems (see Table 2). For example, 26% of basins surveyed had standing water in between storms, as well as wetland vegetation. In each case, the failure was attributed to a locally high water table. Noticeable sediment deposition was observed at 35% of all basins. A review of maintenance records indicated that scarification (sediment scraping) had been conducted at 43% of the sites in the last five years.

The average cost to maintain the basin ranged from \$500 to \$1,000 per year. A frequent maintenance headache was the difficulty in sustaining grass on the basin floor—only 30% of all basins had a dense grass cover crop. The thin grass cover was due to frequent inundation, poor soils, or standing water. Lack of grass cover and the presence of trash and debris often generate complaints from adjacent residents.

The study also compared measured infiltration rates at the basins with the predicted rate, based on the local soil survey or SCS textural estimation method (Table 3). The three methods gave inconsistent and variable estimates of the design infiltration rate. The single ring infiltrometer test tended to give the highest estimates of the infiltration rate, and is often used as a maximum or upper limit in the Puget Sound area. Clearly, for the soils in the Puget Sound Area, and perhaps elsewhere, the various soil infiltration methods provide only a guidepost for the true, but unknown, infiltration rate. Given the critical importance of the infiltration rate in selecting and designing infiltration practices, more research is needed to develop more effective and reliable methods to rapidly calculate it.

A companion study (Gaus, 1993) examined the concentration of trace metals in the surface soils of eight infiltration basins studied by Hilding. The average soil concentrations were 387 mg/kg for zinc, 261 mg/kg for

**Table 1: Current Washington Dept. of Ecology Guidelines for Infiltration Basin Design (1992)**

- Minimum infiltration capacity (fc) of 0.5 inch/hr.
- Maximum clay content of 30%.
- Maximum silt-clay content of 40%.
- Depth to bedrock and high water table of three feet.
- Maximum ponding time of 24 hours.
- Pretreatment required (forebay, biofilter, or sedimentation chamber).
- Measured Infiltration rate reduced by factor of two for design.
- Basins control 6 month, 2 year and 10 year, 24 hr rainfall events. If Fc is greater than 2 in/hr, water quality storm must be treated to protect groundwater.



**R0079964**

**Table 2: Summary of Field Survey of Puget Sound Infiltration Basins**

Field Parameter	Value
No. of basins surveyed	23
Mean age of basins	10.6 years
Mean infiltration rate (in/hr)	15.8 (range 1.1 to 36.0)
Maximum clay content	never exceeded 13% at any site
Had runoff pretreatment	39%
Had standing water	26%
Heavy sediment deposition	35%
Scarified in last 5 yrs. to improve infiltration rate	43%
Had dense grass cover	30%
Needed mowing or seeding	31% to 44%
Annual maintenance cost	\$500 to \$1000 per basin

**Table 3: Method Used to Estimate Soil Infiltration Rates (in/hr)**

Basin #	Soil survey permeability rates (in/hr)	SCS soil texture method	Field measurement single ring infiltrometer
Basin # 1	6-20	1.02-8	26.4
Basin # 2	6-20	20	7.2
Basin # 3	6-20	20	14.4
Basin # 4	6-20	2.4	36
Basin # 5	6-20	2.4	36
Basin # 6	0.6 to 2.0	2.4	19.2
Basin # 7	6-20	2.4	1.1
Basin # 8	6-20	2.4	2.2

lead, and 153 mg/kg for copper. Downward metal migration was not observed at most sites. A notable exception were basins situated on coarse gravelly soils. In these cases, some form of pretreatment prior to infiltration would be advisable to prevent groundwater contamination.

The field surveys do suggest that infiltration basins can still be an attractive stormwater option in regions with a high infiltration rate and stringent design guidelines. Even under these ideal conditions, however, extensive maintenance is required to keep the practice working over the long term.

**References**

Hilding, K. 1993. *A Study of Infiltration Basins in the Puget Sound Region*. ME thesis. Dept. of Biological and Agricultural Engineering. Univ. of California, Davis.

Gaus, J. 1993. *Soils of Infiltration Basins in the Puget Sound Region: Trace Metals and Concentrations*. ME thesis. Univ. of Washington.



# A Second Look at Porous Pavement/Underground Recharge

by Thomas Cahill, Cahill Associates

The optimal stormwater management practice prevents both water quality and quantity impacts. In theory, practices that rely on maintaining the mechanism of soil infiltration are ideal. Allowing the hydrologic cycle to continue in a pre-disturbance condition, so that aquifers are recharged and increased surface runoff pollutant loadings are prevented, is clearly the goal. However, practical engineering solutions based on the infiltration concept have been difficult to design and even more challenging to implement.

The quandary is illustrated vividly by porous pavement, a technique proposed over 20 years ago. After numerous unsuccessful installations, use of porous pavement is routinely rejected by most engineers, designers, and stormwater program managers. Contrary to prevailing wisdom, however, porous pavement/underground recharge bed stormwater practice applications can be developed successfully.

Cahill Associates (CA), a suburban Philadelphia environmental engineering firm, has been designing and constructing porous pavement/recharge bed installations in Middle Atlantic state locations for over 12 years. Their porous pavement installations serve a

range of building parking needs and customers include office centers, fast food restaurants, libraries, and condominiums. Areas covered range from 3,000 to 147,000 square feet.

Experience has shown that most porous pavement failures occur because of a lack of erosion/sediment control during construction. In many instances, contractors, unfamiliar with *what* they were doing and *why* they were doing it, allowed substantial quantities of sediment to erode onto the pavement surface after installation. Construction traffic also tracks heavy loads of clay particles onto the surface. Void spaces in the porous asphalt became permanently clogged, preventing stormwater from even entering the recharge bed below.

The fine silts that managed to pass through the porous pavement and through the underlying rock-filled recharge beds then settled out on the recharge bed bottom, reducing the recharge bed's ability to infiltrate over time. These failures have made stormwater managers generally very reluctant to recommend porous pavement as a stormwater practice, rejecting the technology as impossible to apply in the real world.

Figure 1: A Typical Porous Pavement/Recharge Bed Design

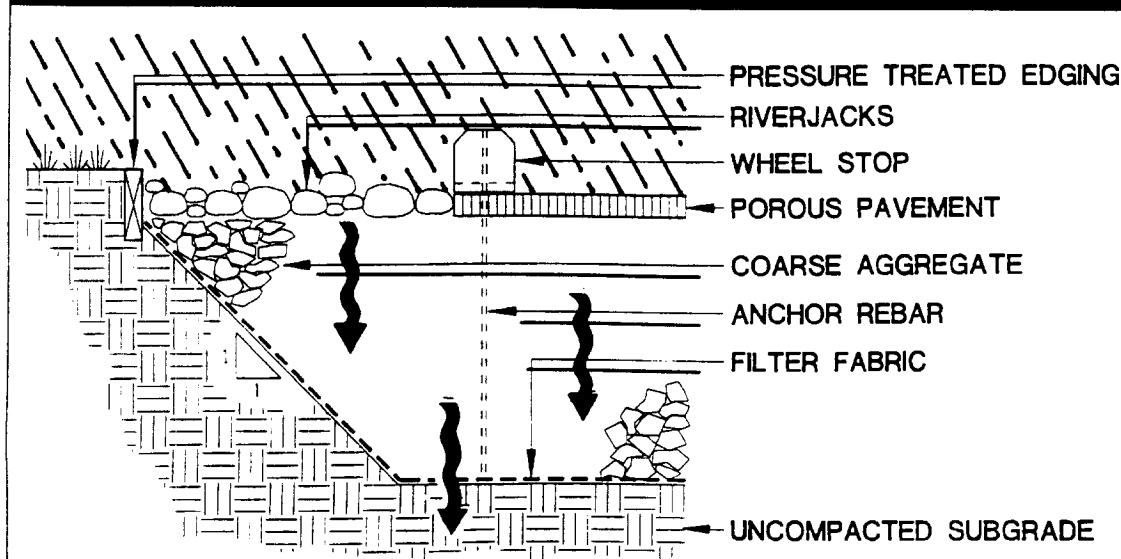

Source: Cahill Associates



R0079966

Success has been frequently demonstrated, however, when project designs have adhered to the following guidelines. Importantly, these specifications add only marginally to total project costs.

- **Site conditions such as permeability of the soil must be verified.** Field verification of a soil layer of reasonable thickness (four feet or more) with acceptable drainage qualities (percolation rate of 0.5 inches per hour or more) is essential. The most cost-effective method of field testing will vary with each site and its geological complexity.
- **All sediment-laden runoff must be directed away from the porous pavement/recharge bed.** Total site design and stormwater drainage planning must be tailored to porous pavement/recharge bed requirements. While all runoff from impervious surfaces (roof tops, roads, parking areas, walkways, and so forth) should be directed onto the porous pavement and then into the recharge bed, pervious zones being re-landscaped after construction must be redirected away from the bed, or pretreated so as to eliminate sedimentation and resultant clogging. Strict erosion and sedimentation controls are a must.
- **Special safeguards/redundancies should be included in the porous pavement/recharge bed design.** Project success has resulted in part because of certain engineering features in porous surface/recharge bed design (see Figure 1 and Table 1).
  - (1) Selected filter fabric is placed generously on the floor and sides of the recharge bed after excavation/bed preparation, providing an inexpensive barrier between the stone-filled recharge bed and the soil mantle interface. This filter fabric allows water to pass readily, but prevents soil fines from migrating up into the rock basin, reducing the effective storage volume of the recharge bed.
  - (2) In the event that the porous pavement becomes clogged, the edge of the porous paved area is designed to function as a linear overflow inlet around the perimeter of the parking bay. The inlet is accomplished quite simply by allowing a width of the bed around the perimeter to go unpaved, later to be topped off with a decorative river stone of some sort. Wheel stops are placed at the edge of the pavement, preventing vehicles from disturbing this emergency overflow.
  - (3) Most intense traffic is directed away from porous surfaces. Porous surfaces are limited to parking areas receiving least wear and tear. Roadways ringing the parking areas receive

conventional pavement, but drain into the recharge beds.

- **Communication with contractors is essential.** Contractors/workers involved with the project must understand what is being done and why compliance with specifications is essential. The nature and purpose of the porous pavement/recharge bed technique must be liberally entered onto the construction drawings and included within the written specifications for the project. Before construction, these specifications must be reviewed verbally and in person with contractors.
- **Installation must be supervised and spot-checked.** Proper inspection/supervision during construction of the porous pavement/recharge bed should be budgeted into all projects. Spot-checking by the engineer early on is essential. Regulatory agencies such as the local conservation district cannot be relied upon to make sure that plans and specifications are being executed fully. Contracts, bids, and budgets must include necessary inspection by the design engineer. A written record must be maintained including review and approval at critical project junctures, such as excavation of recharge beds, placement of filter fabric, and quality control at the stone crushing plant and asphalt mix plant. In addition, site inspection and supervision must make sure that construction vehicles are not allowed to traverse excavated recharge beds or enter the completed porous pavement, and that all erosion control measures are in place.

Cahill Associates and others recommend that completed porous pavement be vacuum-cleaned twice per year under normal circumstances, using commercially available pavement vacuuming equipment (either through vendor services or through outright purchase). Although many installations continue to function, in most cases this maintenance has not been performed, primarily because of a lack of communication between the contractor and site owner. Therefore, in new projects, specifications include the requirement that site owner maintenance staff be given copies of porous pavement/recharge bed maintenance requirements for future use. Also required are permanent signs (one per parking bay; minimum of two per project) containing a short list of maintenance requirements. For educational value, signs can highlight major benefits of the installation.

The porous pavement/recharge bed stormwater practice is not ideal for all developments and all sites. Clearly, if soils and geology do not allow for minimum necessary rates of infiltration, this type of stormwater management strategy makes no sense. The majority of upland soils in the eastern U.S., however, do have at least moderate infiltration capacities. In some coastal areas with excessively coarse sands infiltration rates

may be excessively rapid, and the recharge approach may need to be augmented with a peat liner for water quality reasons.

Environmental benefits of the porous pavement approach to stormwater management are compelling. As with any new technique, mistakes must be antici-

pated. However, if reasonable safeguards are taken, the porous pavement approach offers a uniquely elegant engineering solution for many sites as well as providing compelling environmental and cost savings advantages when compared with most other stormwater practices.

Table 1: Ten Tips for More Successful Porous Pavement Applications

1. **Contract with a Design/Build Firm.** These firms have the incentive to perform a careful and thorough job during each stage of design and construction.
2. **Perform Detailed Geotechnical Tests at the Proposed Site.** After further testing of soils and water table, as many as 25% of "ideal" sites are found to be inadequate for porous pavement. By catching these problem sites early, future problems can be avoided.
3. **Only Consider if Client is Informed and Responsible.** The owner of a porous pavement site plays a key role in maintaining and operating the stormwater practice. Large corporate office park clients are ideal as they often continuously own and manage both the practice and the property over several decades.
4. **Design a Perimeter Stone Filter Inlet as a Backup.** Extending the stone filter course several feet outside the perimeter of the porous pavement provides a cheap and reliable means of getting runoff into the stone filter chamber in the event that the porous pavement ever clogs.
5. **Utilize a Choker Layer of Stone in the Filter Course.** The stone reservoir is normally constructed with a top layer of 1/2 inch gravel over a bottom layer of larger 1.5 to 3.0 inch stone. To avoid uneven surfaces, it is helpful to add a thin "choker layer" of fine gravel between the two layers of stone.
6. **Overlap Filter Fabric on Sides During Construction.** By generously extending filter fabric above the surface of the porous pavement (and staking it to adjacent pervious areas) an extra measure of sediment protection can be achieved during construction.
7. **Pave Roads and Intensively Traveled Areas with Conventional Pavement.** Heavily travelled areas tend to clog more rapidly. Therefore, these areas should be conventionally paved, and then graded to drain over to adjacent porous pavements.
8. **Use Terraces of Porous Pavement on Sloping Sites.** Porous pavement can be used on moderately sloping sites, if a series of stone reservoirs are used in a terrace-like arrangement.
9. **Avoid the Use of Porous Pavement in Hydrocarbon Hotspots.** Gas stations, truck stops and industrial sites are poor choices for porous pavement, given the higher risk that pollutant spills could enter groundwater.
10. **Direct Runoff from Pervious or Exposed Areas Away from Pavement.** It is critical to keep sediment away from porous pavement both during and after construction. This can be accomplished by grading adjacent pervious areas to drain away from the parking area and maintaining extensive sediment controls during construction.

8

R0079968

# The Risk of Groundwater Contamination from Infiltration of Stormwater Runoff

by Robert Pitt, Associate Professor, University of Alabama-Birmingham

**F**ew pollutants ever disappear from the urban landscape. They are merely transferred from one medium to another—from air to land, from land to surface water, or from soil to groundwater. This last interaction is of great interest when it comes to the infiltration of urban stormwater. What is the risk that pollutants in urban stormwater might contaminate groundwater as a result of infiltration?

Infiltration is used as a technique to treat both the quality and quantity of urban runoff. It diverts runoff back into the ground in an attempt to replicate the normal hydrological cycle, whereby most rainfall infiltrates into the soil. Infiltrating runoff, rather than rainfall, can create some risks, particularly since runoff is likely to have picked up pollutants along the way.

To answer these questions, the University of Alabama-Birmingham and EPA Office of Research and Development embarked on a three-year cooperative study to define the nature of the potential risks to groundwater. Their preliminary results are shown in Table 1. The risk analysis is based on three key factors that influence a compound's movement into groundwater: its relative mobility, concentration and solubility. For example, a compound present at high concentration that is both mobile and soluble in soils and groundwater is a much greater risk than a relatively immobile and particulate-oriented compound.

The next stage of the risk assessment evaluates the ease of entry into groundwater. Typically, stormwater runoff is introduced to groundwater in one of three ways:

1. Sedimentation or filtration prior to infiltration into soils
2. Surface infiltration into soil
3. Subsurface injection into groundwater

An example of the first infiltration method would be a sedimentation chamber leading to an infiltration trench. In this instance, some compounds could be trapped in the sedimentation chamber and never enter the trench. A typical example of the second method is a grass swale without any pretreatment. Here, the compound percolates through the surface soils before reaching groundwater. Depending on the distance, the compound may be adsorbed and fixed onto soil. The last infiltration method involves routing stormwater deep into the ground, such that it does not pass through

or come into contact with the soil layer. Consequently, there is little chance that a compound will be removed before it enters groundwater.

The analysis should only be used for an initial screening estimate of contamination potential because of its simplifying assumptions. These include the assumption that underlying soils are sandy and of low organic matter content, which represents a worse case scenario in many communities. Second, the values for a compound's abundance and solubility in runoff were derived from residential and commercial areas only. Urban hotspots, such as vehicle service operations and industrial areas, were not explicitly included in the analysis. Recent research indicates that these land uses may often have both higher concentrations and frequency of detection for many compounds (see Table 2).

The stormwater pollutants with the greatest potential for possible groundwater pollution include the following:

- *Nitrate-nitrogen.* This mobile compound has a low to moderate potential for groundwater contamination, but only because nitrate is generally found in relatively low concentrations in urban stormwater (1 to 3 mg/l).
- *Pesticides.* Lindane and Chlordane both have moderate contamination potential for surface infiltration or subsurface injection. The contamination potential can be greatly reduced, however, if runoff is pretreated before entering an infiltration facility.
- *Other organic compounds.* 1,3 dichlorobenzene, pyrene and fluoranthene all are predicted to have a high groundwater contamination potential for subsurface stormwater injection. Again, their contamination potential drops sharply for surface infiltration due to their sorption onto soils in the vadose zone. Thus, most organic compounds have a low risk of contamination with adequate runoff pretreatment and soil percolation.

**Table 1: Groundwater Contamination Potential for Selected Stormwater Pollutants  
(Pitt et al., 1994)**

Compounds	Risk Factor			Contamination Potential		
	Mobility in soil	Abundance in stormwater	Filterable fraction	No pretreatment	Pretreatment*	Sub-surface injection
nitrate	H	L-M	H	L-M	L-M	L-M
2,4-D	H	L	L	L	L	L
lindane	M	M	L	M	L	M
malathion	H	L	L	L	L	L
atrazine	H	L	L	L	L	L
chlordan	M	M	VL	M	L	M
diazinon	H	L	L	L	L	L
VOCs	H	L	VH	L	L	L
1,3-dichloro benzene	L	H	H	L	L	H
anthracene	M	L	M	L	L	L
benzo(a) anthracene	M	M	VL	M	L	M
bis(2-ethyl hexyl) pthalate	M	M	L?	M	L?	M
butyl benzyl pthalate	L	L-M	M	L	L	L-M
fluoranthene	M	H	H	M	M	H
fluorene	M	L	L?	L	L	L
naphthalene	L-M	L	M	L	L	L
pentachloro phenol	M	M	L?	M	L?	M
pbenanthrene	M	M	VL	M	L	M
pyrene	M	H	H	M	M	H
entroviruses	M	P	H	H	H	H
Shigella	L-M	P	M	L-M	L-M	H
Pseudomonas	L-M	VH	M	L-M	L-M	H
protozoa	L-M	P	M	L-M	L-M	H
nickel	L	H	L	L	L	H
cadmium	L	L	M	L	L	L
chromium	VL-M	M	VL	L-M	L	M
lead	VL	M	VL	L	L	M
zinc	L-VL	H	H	L	L	H
chloride	H	H	H	H	H	H

VL, Very low; L, Low; M, Moderate; H, High; VH, Very high  
\* by sedimentation filtration



R0079970

**Table 2: Detection Frequency and Maximum Concentrations for Selected Organic Compounds (Pitt et al., 1994)**

Toxicant	Detection Frequency (%)	Maximum observed concentration (µg/l)
Benzo-(a) anthracene	12	60
Benzo(b) fluoranthene	17	226
Benzo(k) fluoranthene	17	221
Benzo(a) pyrene	17	300
Fluoranthene	23	128
Naphthalene	13	296
Phenanthrene	10	69
Pyrene	19	102
Chlordane	13	2.2
Butyl benzyl phthalate	12	128
Bis (2-chloroethyl) ether	14	204
Bis(2-chloroisopropyl) ether	14	217
1,3 dichlorobenzene	23	120

- **Pathogens.** Enteroviruses and other pathogens all have a high groundwater contamination potential. The actual risk, however, depends on their presence in urban stormwater, of which not much is reliably known, based on current monitoring data. Clearly, the risk is greatest in areas where sewage is mixed with stormwater (e.g., combined sewer overflows and illicit connections).
- **Heavy Metals.** Zinc and nickel pose a risk of groundwater contamination under subsurface injection. The risk is sharply reduced, however, when runoff is pretreated and percolates through the soil layer.
- **Salts.** Chlorides appear to be a chronic risk for groundwater contamination, particularly in northern areas where they are applied on roads and highways. No method of pretreatment of percolation appears capable of reducing this potential.

Based on the risk assessment and current knowledge about pollutant source areas, Pitt and his colleagues offer several guidelines on using infiltration practices. For example, it is recommended that runoff be diverted away from an infiltration practice if it is generated from one of the following source areas:

- **Dry weather flows from a storm drain pipe.** These flows often are generated by illicit or illegal connections to the storm drain system, and thus have a strong probability of containing high concentrations of soluble heavy metals, pesticides, and pathogenic microorganisms.
- **Combined sewer overflows (CSOs).** CSO discharges should be kept away from infiltration practices given their poor water quality (especially pathogens) and high clogging potential.
- **Snowmelt runoff from roads and parking lots.** These areas produce high concentrations of chlorides that cannot be effectively treated with infiltration.
- **Manufacturing sites.** Stormwater from these sites has a high potential for elevated concentrations of organic compounds and heavy metals.
- **Construction sites.** While stormwater from construction sites does not normally contain toxicants, the high sediment levels quickly clog infiltration practices.

Adequate pretreatment of runoff prior to the use of infiltration is recommended for other critical source areas, such as gas stations, vehicle maintenance operations, and large commercial parking lots.

Residential areas pose the least risk of groundwater contamination, and therefore, infiltration practices can be located without extensive pretreatment. However, the use of grass buffer strips and other forms of pretreatment is still advisable to prevent premature failure of the infiltration practice due to clogging.

Additional monitoring and testing of stormwater/groundwater interactions is being conducted to further refine these recommendations.

#### References

- Pitt, R., K. Parmer, S. Clark and R. Field. 1994. *Potential Groundwater Contamination from Intentional and Nonintentional Stormwater Infiltration-1993 Research Project*. Cooperative Agreement No. CR 819573 EPA/600/SR-94/051. Storm and Combined Sewer Pollution Control Program US. EPA. Cincinnati, OH. Avail. from NTIS(703)487-0650.

R0079971

R0079972

# Filters





# Article 105

Feature Article from *Watershed Protection Techniques*, 1(2): 47-54

## Developments in Sand Filter Technology to Treat Stormwater Runoff

The use of sand filtration to improve water quality is not a new concept. Slow sand filtration has been used for decades to treat wastewater and purify drinking water in many parts of the globe. In this respect, sand filtration has been demonstrated to be both an economical and effective option for removing pollutants.

The City of Austin, Texas first pioneered the use of sand filters to treat urban stormwater runoff in the early 1980s. The earliest designs consisted of a simple off-line sedimentation chamber and an 18-inch bed of sand (Figure 1). The first flush of runoff is diverted into the first sedimentation chamber. In this chamber coarse sediments drop out and the runoff velocities are reduced. Runoff is then spread over the sand filter bed where pollutants are trapped or strained out. A series of perforated pipes located in a gravel bed collect the runoff passing through the filter bed and subsequently return it into the stream or channel.

This type of sand filter was developed in Austin because no other stormwater management practice works well in the Texas hill country. High rates of evapo-transpiration and frequent droughts ruled out the use of ponds and marshes. Thin clay soils and a desire to protect groundwater quality eliminated the use of infiltration practices. Low soil moisture during the hot and dry summers made it difficult to establish dense and vigorous cover needed for vegetative practices. Stormwater designers were thus forced to create a closed and self-contained practice with an artificial filtration media. Hence, the sand filter was developed.

Sand filters have many advantages. They have a moderate to high pollutant removal capability, possess very few environmental limitations, require small amounts of land, and can be applied to most development sites, large or small. Compared to most other stormwater management practices, they have fewer limitations and constraints. These qualities have made

Figure 1: Original Sand Filter Design Developed in Austin, Texas (City of Austin, 1988)

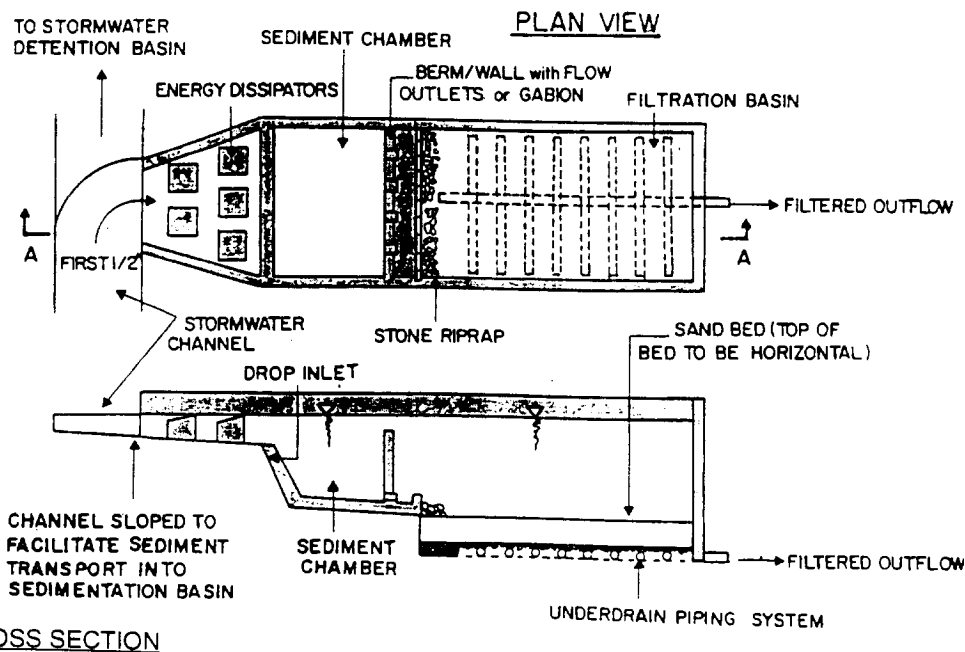

R0079974

**Table 1: Comparison of Sand Filter Design Variants**

<b>DESIGN VARIABLES</b>	<b>Austin Sand Filter Full Sedimentation</b>	<b>Austin Sand Filter Partial Sedimentation</b>	<b>District of Columbia Under-ground Sand Filter</b>	<b>Delaware Sand Filter</b>	<b>Alexandria Stone Reservoir Trench</b>	<b>Texas Vertical Sand Filter</b>	<b>Peat Sand Filter</b>	<b>Washington Com-post Filter System</b>
<b>Applicable Development Situations and Drainage Area</b>	Most sites can serve 1 to 30 acres		No more than 10 impervious acres of high urban D.A.	No more than 5 acres of impervious parking lot	2 to 3 acres max. of commercial or multi-family	Primarily roadway runoff to date	1 to 50 acres	1 to 50 acres
<b>Filter Bed Profile</b>	18" sand, 4-6 inches of gravel. A layer of sod on the surface of the filter bed is optional.		Gravel or Enkadrain screen over 30" of sand	18" of sand	2-4 feet of stone, over 18" of sand and 6" of gravel	Up to 6 feet of sand supported by gabions on either side	Grass on 12" of peat and 2 feet of sand, then gravel	One foot of compost over 8" of rock and gravel
<b>Filter Bed Area (sf/la)</b>	100	180	200	360	183	N/A	436	200 ft per cfs
<b>Total Treatment Volume</b>	First 1/2" of runoff with 24 hr. drawdown sediment chamber	First 1/2" of runoff S.C. = 20% of WQV	First flush of runoff (0.3" to 0.5")	First 1" of runoff	First 1/2" of runoff	First 1/2" of runoff	First 1/2" of runoff	N/A
<b>Pretreatment Method</b>	Dry sediment chamber	Dry sediment chamber	3 foot wet micropool plus gravel or geo-textile screen	Shallow wet pool	Wet micropool stone blanket	Dry sediment chamber	Wet micropool	Dry sediment chamber
<b>Pretreatment Volume</b>	sc >> fb	sc ~ = fb	sc >> fb	sc = fb	sc < fb	sc >> fb	0.1 acre-inch sc < fb	sc < fb
<b>Performance Monitoring Data Available?</b>	Yes, 4 sites with 2 more in progress		No, 2 in progress	No, 2 in progress	No	No, 1 in progress	No	Yes, 2
<b>No. Currently Installed</b>	~500	~500	~50	~25	~10	~5	~5	25

Notes: sf/la = square foot of filter bed area per impervious acre  
 sc = sedimentation chamber fb = filter bed

**R0079975**

Figure 2: Cross-Section of Sand Filter Design Variations

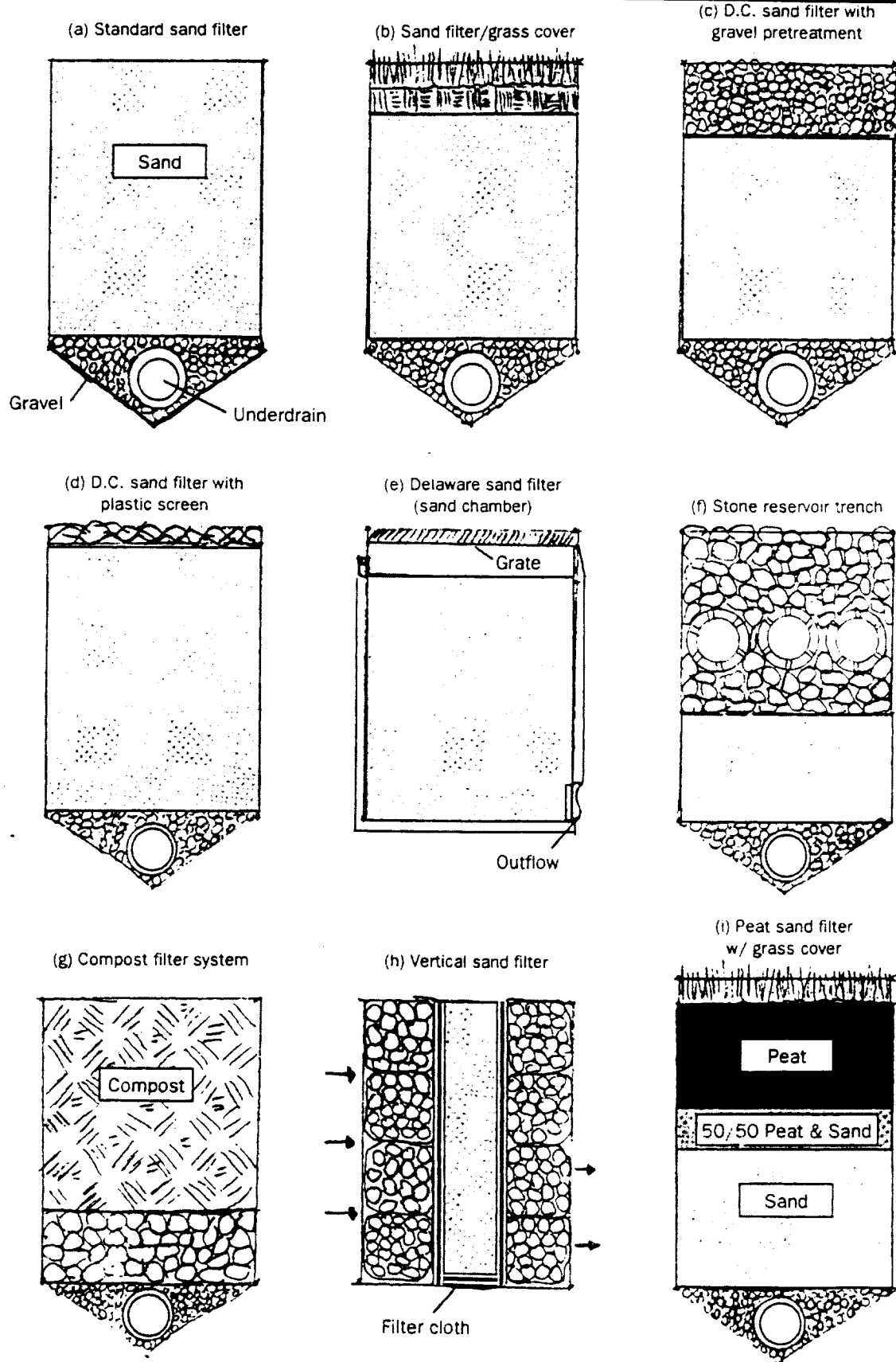

**Table 2: Comparison of Sand Filter Design Variants**

Filter Type	Design Issues
Austin Sand Filter Full Sedimentation	Requires basin liner, 2:1 length to width ratio. Sand must have a grain size $\leq$ concrete sand.
Austin Sand Filter Partial Sedimentation	Requires more frequent sand replacement than full sedimentation design. Requires basin liner.
District of Columbia Underground Sand Filter	Need head-room, must avoid underground utilities. Must ensure each chamber is watertight, may require 4 - 8 ft. of head.
Delaware Sand Filter	Requires very little head. Grate covers each chamber for access. Need to consider structural design with traffic load. Can freeze in northern climates.
Alexandria Stone Reservoir Trench	Not recommended for parking lots.
Texas Vertical Sand Filter	Most filtration may occur in small area of filter. Ability to withstand clogging has not been demonstrated.
Peat Sand Filter	Need to select appropriate peat. Peat may not always be available. Difficulty in operating during winter conditions.
Washington Compost Filter System	Leaf compost must be carefully selected and replaced regularly.

the sand filter an attractive alternative stormwater practice for many communities across the country.

This article examines recent developments in the use of sand filtration to improve the quality of urban stormwater runoff. It summarizes what is known about the performance and operation of sand filters, based both on recent research and the experience of engineers and public works officials that have installed and maintained them.

**Design Variations of the Sand Filter**

The versatility of the sand filter is reflected in the numerous design variations that have been developed to address many different climatic and development conditions. Nearly a dozen variants of the basic sand filter design are currently in use, and engineers and practitioners continue to create more. Some of the more common designs are compared in Tables 1 and 2, and illustrated in Figure 2.

In general, sand filter designs can be grouped into two broad categories:

- Designs that are well established
- Designs that are still somewhat experimental (due to a lack of implementation experience and/or performance monitoring data)

Each sand filter design utilizes a slightly different profile within the filter bed (Figure 2). The required surface area of the filter is usually a direct function of the impervious acreage treated, and varies regionally due to rainfall patterns and local criteria for the volume needed for water quality treatment. In addition, designs often differ with respect to the type and volume of pretreatment afforded.

The most common form of pretreatment is a wet or dry sedimentation chamber. Gravel or geotextile screens are sometimes used as a secondary form of protection. The relative volume dedicated to pretreatment versus filtration tends to vary considerably from one area to the next (Table 1). Nearly all sand filters are constructed off-line. Runoff volumes in excess of the water quality treatment volume must be bypassed to a downstream quantity control structure.

**Feasibility of Sand Filters**

Some kind of sand filter can be applied to almost any development site. The primary physical requirement is a minimum of two or three feet of head differential existing between the inlet and outlet of the filter bed. This is needed to provide gravity flow through the bed.

Otherwise, the use of sand filters is only limited by their cost and local maintenance capability. Sand filters are particularly suitable for smaller development sites where other stormwater practices are often not practical. These include the following:

- Infill developments
- Ultra-urban downtown areas
- Gas stations and fast food establishments
- Commercial and institutional parking lots
- Small shopping centers
- Townhouse and multifamily developments
- Confined industrial areas

Care should be exercised in approving sand filters for individual lots and residential developments, as most homeowners lack the incentives or resources to regularly perform needed sand replacement operations. The State of Florida is considering limitations on the use of sand filters in residential areas, given the generally poor maintenance record of homeowner associations (Livingston, 1994).

**Pollutant Removal Performance of Sand Filters**

Presently, performance monitoring data for sand filters is rather sparse. Frequently cited are results from four sand filters that were sampled in Austin, Texas in the late 1980s (Table 3). However, at least seven additional performance monitoring studies are now in progress in Texas, Delaware, Florida, Virginia, the District of Columbia, and Washington with results expected in the next six to 18 months.

Initial monitoring results suggest that sand filters are very effective in removing particulate pollutants such as total suspended solids, lead, zinc, organic carbon, and organic nitrogen (City of Austin, 1990). Removal rates in excess of 75% were frequently observed for each of these parameters. Removal rates for coliform bacteria, ammonia, ortho phosphorus, and copper were moderate, and quite variable. Results ranged from 20 to 75% in the four sand filters tested in Austin.

Negative removal rates were frequently reported for total dissolved solids (TDS) and nitrate-nitrogen. The negative TDS rate may be due to the preferential leaching of cations from organic matter trapped on the surface of sand filter. Similarly, the nitrate export observed in three of the four sand filters may indicate that nitrification is taking place in the filter bed. In the nitrification process, microbial bacteria converts ammonia-nitrogen into the nitrate form of nitrogen. The apparent loss of ammonia through the filter bed, coupled with the production of excess nitrate, strongly suggests that nitrification is taking place.

The pollutant removal behavior of stormwater sand filters is quite comparable to that reported for sand filters used in wastewater treatment (Ellis, 1987). There are some differences between the two systems, however. Wastewater sand filters typically contain finer sand, are cleaned more frequently, and subject to more uniform and controlled flow than their stormwater counterparts. Consequently, wastewater filters exhibit slightly higher removal rates for sediment, phosphorus, and organic carbon (often in excess of 90%), but seldom can achieve more than 20% removal of nitrate (again, due to nitrification).

The one exception where wastewater filter consistently outperformed stormwater filters was bacteria removal. Wastewater filters frequently reduced bacteria levels by 90%, compared to a 25 to 65% removal for stormwater sand filters.

### Prospects for Improving the Performance of Stormwater Filters

Designers are constantly refining the basic sand filter design to increase the level and consistency of nutrient and bacteria removal. A popular approach has been to add an additional organic layer to the filter bed to increase pollutant removal capability. A series of organic media have been used including a top layer of grass/soil, grass/peat or compost, a middle layer of peat, activated carbon, and even zeolites.

Very few of these "sandwich systems" have been extensively monitored so far. The Highwood sand filter (see Figure 2) had a top layer of grass sod over the sand filter, and generally performed slightly worse than the other three Austin filter systems (City of Austin, 1990). The stormwater compost system which

**Table 3: Pollutant Removal Performance of Four Sand Filters in Austin, TX — Pollutant Removal Accounts for Bypassed Flows (City of Austin, 1990)**

Parameter	Highwood	Barton Creek	Joleyville	Brodie Oaks
Total solids	86	75	87	92
Total dissolved solids	(-35)	1	31	46
BOD (5-day)	29	39	52	77
Total organic carbon	53	49	62	93
Nitrate	(-5)	(-13)	(-79)	23
Ammonia	59	43	77	94
Total Kjeldahl nitrogen	48	64	62	90
Total nitrogen	31	44	32	71
Total phosphorus	19	59	61	80
Fecal coliforms	37	36	37	83
Fecal strep	50	25	65	81
Copper	33	34	60	84
Lead	71	88	81	89
Zinc	49	82	80	91
Iron	63	67	86	84

relies exclusively on an organic filtering medium (see article 109) also had negative or low removal of TDS, nitrate, and phosphorus (Stewart, 1992). The limited data on sandwich systems so far indicates that the sandwich layer could actually be a source for some pollutants, while effectively trapping others.

Another option to improve sand filter performance is to create a permanently saturated, anaerobic zone at the bottom of the filter bed. Conditions in this zone are favorable for denitrification, which might substantially improve the rate of nitrate removal. Some caution may be in order as anaerobic conditions could possibly lead to loss of other pollutants (Harper and Herr, 1992). Other untested methods for enhancing performance may include increasing the surface area of the filter bed, specifying the use of finer sand, and increasing the depth of the sand layer.

It should be noted that sand filters, as an off-line practice, will always bypass some fraction of runoff during larger storm events. This runoff will be untreated. Depending on local water quality sizing criteria, the volume of untreated runoff can amount to 10 to 20% of the annual runoff volume produced at the site.

Perhaps the most reliable option for improving sand filter performance is to combine a filter with another stormwater practice such as an extended detention pond, wet pond, or shallow marsh. For example, the best performing sand filter in the Austin monitoring project was at Brodie Oaks, which combined a retention pond with a sand filter (see Table 3).

### Sand Filter Maintenance

Regular maintenance is an essential component of the operation of a sand filter. At least once a year each



**R0079978**

filter should be inspected after a storm to assess the filtration capacity of the filter bed. Most filters exhibit diminished capacity after a few years due to surface clogging by organic matter, fine silts, hydrocarbons, and algal matter. Maintenance operations to restore the filtration capacity are relatively simple—manual removal of the top few inches of discolored sand followed by replacement with fresh sand. The contaminated sand is then dewatered and land-filled.

The key point is that the operation of the sand filter requires replacement of the surface sand layer on a relatively frequent basis, just as in wastewater sand filter applications. If periodic sand replacement is not conducted, the filter will not be effective. Livingston (1994) reports chronic clogging problems in many of the sand filters installed in residential areas in Florida due to lack of maintenance and off-site sediment deposition.

In some cases sand filters can continue to function after partial clogging. For example, Shaver and Baldwin (1991) reported that a demonstration sand filter accumulated several inches of deposits over the sand filter bed after six years, but it still functioned, at least partially. Based on the one sample obtained from a Delaware site, sand filter deposits appear to have the same degree of sediment contamination as pond muck and thus may not pose a risk for land disposal (Shaver and Baldwin, 1991). However, this conclusion should be considered provisional until further testing of more filter sediments are obtained from sites that are heavily influenced by automotive or industrial uses.

A number of techniques are being developed to reduce the frequency of sand replacement or to make the operation more convenient.

- **Surface Screen.** Underground sand filters in heavily urbanized areas tend to receive large quantities of trash, litter, and organic detritus. To combat this problem, the District of Columbia specifies the use of a wide mesh geotextile screen (EnkaDrain 9120) on the surface of the filter bed to trap these materials. During maintenance operations the screen is rolled up, removed, cleaned, and reinstalled.
- **Careful Selection of Sod.** Some sand filters that are constructed with a grass cover crop have lost significant filtration capability soon after construction. The clogging is often traced to sod that has an unusually high fraction of fine silts and clays. In other situations, grass roots grow into the sand layer and improve the filtration rate.
- **Limiting Use of Filter Fabric to Separate Layers.** Often the loss of filtration capacity occurs where filter fabric is used to separate different layers or media within the filter bed, such as in "sandwich" filters. As a general rule, the less use

of filter fabric to separate layers, the better. In many situations, layers of different media can be intergraded together at the boundary (e.g., 50:50 peat/sand), or by a shallow layer of pea gravel.

- **Providing easier access.** During sand replacement operations, heavy and often wet sand must be manually removed from the filter bed. It is surprising that so few designs help a maintenance worker conveniently perform this operation. It is not uncommon that sand must be lifted six feet or higher to get it out of the filter bed. Yet typically no ramps, manhole steps, or ringbolts are provided to make the operation easier.

Engineers should also keep in mind the ergonomics of maintenance when designing access to the sand filter. In some cases, heavy grates or large diameter manhole covers are specified that cannot be opened without the use of a portable winch.

- **Pretreatment.** The frequency of sand replacement can also be reduced by devoting a greater volume to runoff pretreatment in the sedimentation chamber. Several designs provide up to 50% of the total runoff treatment volume in the sedimentation chamber.
- **Visibility and Simplicity.** When tinkering with new sand filter designs, two key principles should be kept in mind. First, the filter should be visible, i.e., it should be easily recognized as a stormwater practice (so that owners realize what it is) and be quickly located (so that it can be routinely inspected). This often requires the designer to consider the appearance and aesthetics of the final product so that it does not come to resemble

**Table 4: Construction Costs for Various Types of Sand Filters**

Region (Design)	Cost/Imperv. Acre
Delaware	\$10,000
Alexandria (Del.)	\$23,500
Austin (>2 acres)	\$16,000
Austin (>5 acres)	\$ 3,400
DC (underground)	\$14,000
Denver (Urbonas and Stahre, 1993)	\$30 - \$50,000
OIL-GRIT SEPARATOR	\$ 8,000
INFILTRATION TRENCH (WCC, 1992)	\$ 800-1200
PONDS (WCC, 1992)	\$ 400-1200

a concrete sandbox. The second principle is that the design should be kept as simple as possible. Experience has shown that overly complex designs create greater operation and maintenance costs.

- **Imperviousness.** Limit sand filters only to sites that are entirely impervious.

#### Economics of Sand Filters

Constructing sand filters can be expensive (Table 4). Construction costs often range from \$10,000 to \$20,000 per impervious acre treated, depending on the design. Sand filters can cost as much as five to 10 times more per unit of runoff treated than conventional stormwater practices, exclusive of land costs.

It should be noted, however, that many sand filters require little or no developable land (since they are located underground or on the margin of parking lots), which can make filters a more competitive option. The drawback is that sand filters do not provide stormwater quantity control. Thus, savings in land consumption may be offset by the costs of constructing additional stormwater quantity controls elsewhere on the site.

In many small, highly urbanized development situations sand filters are often the only practical stormwater quality practice, making cost comparisons meaningless. Indeed, the relatively high treatment cost for sand filters may prove useful as a benchmark to set and justify waiver fees for small development sites, when no stormwater practice options are practical.

Economies of scale do exist for sand filters. It is, for example, much cheaper to build a filter serving a large drainage area than a small area. Tull (1990) reports construction costs of \$16,000/acre for a filter on one acre compared to \$2,700/acre for one built to manage 20 acres. In addition, construction costs for sand filters can be expected to drop over time. These savings reflect greater use of precast or modular components, better construction specifications, and greater experience on the part of contractors. For example, Bell and Nguyen (1993) report a drop of nearly 50% in the cost of constructing underground sand filters over a five year period.

Not much is known about the cost to maintain sand filter over the long term, or, for that matter, the cost of sand replacement operations. Given the importance of maintenance, the collection of such information should be a key priority.

#### Regional Design Considerations

Communities that are considering sand filters in their arsenal of watershed protection techniques should keep in mind several regional design issues.

- Sand filters have yet to be widely applied in colder northern climates. Clearly, an extended cold snap could freeze the sedimentation chamber and perhaps even the surface of the filter bed (particularly for designs with relatively shallow chambers). If this happens, the filter may be temporarily rendered partially or entirely ineffective. It is therefore quite prudent to design a bypass that will route excess runoff directly into the storm drain system or stream channel under these conditions. A few designs, such as the peat sand filter, are not designed to operate in the winter months.
- The delta-T of sand filters has yet to be measured to determine if they contribute to warming of sensitive cool or cold-water streams. On one hand, sand filters might cool incoming runoff since it must pass through the sand and gravel layers of the filter bed. On the other hand, cooling may be more than offset by warming in the sedimentation pool or from concrete surfaces.
- Sand filters need not always be lined by concrete to work effectively. In regions where groundwater quality is not a critical concern (e.g., communities that allow or encourage the infiltration of stormwater), the bottom and sides of the filter bed can be contained by geotextile or even soil liners. The filter bed is excavated, permeable filter fabric used to line the bottom and sides of the structure, and then sand added.

#### Further Research and Development

Sand filters are a very promising and potentially useful stormwater practice. Yet, much more still needs to be learned before they can be routinely and cost-effectively applied in many regions of the country. Questions include the following:

- How well does the design filtration rate hold up over time? Does it vary from season to season due to leaf fall or frozen conditions? Does the filtration rate recover as organic surface deposits gradually decompose?
- Research into these questions will help to define "run-time" of a filter (i.e., how often sand must be replaced). To optimize removal, engineers have found it necessary to accurately predict how long wastewater filters will run before they must be backflushed or replaced. The same kind of operational data will ultimately be needed for stormwater filters.
- Can the efficiency of pretreatment be improved? Would a gravel filled sedimentation chamber be more effective than an empty one?  
Some researchers have concluded that gravel filters are superior to conventional sedimentation



R0079980

basins for pretreatment in wastewater sand filters (Ellis, 1987; Wegelin, 1983). So far, this approach has not been used for stormwater sand filters, possibly because of the difficulties in cleaning a gravel chamber.

- Should additional media be added to sand filters to increase their nutrient removal capability?

Clearly, there are some risks that these additional layers of organic material could reduce the run time of the filter, or even possibly be a source of pollutant leaching. Some researchers are even testing inorganics including ferric chloride and aluminium sulfate precipitates. Only through controlled laboratory column experiments with various combinations of filter media can these questions be answered.

In addition to the above, there are several interesting questions about sand filters that remain. Do sand filters contribute to downstream warming? Are accumulated deposits on the filter bed toxic or hazardous when the filter serves a highly automotive or industrial site? Are there better combinations of sand grain size or filter bed depth that might improve the effectiveness of a sand filter? What is the optimal type and volume of pretreatment? What design refinements can reduce construction or maintenance costs?

#### An Overall Assessment

The design of sand filters is evolving rapidly, and promises to remain a fertile ground for innovation for years to come. Some experimental approaches will prove successful, while others will doubtless be discarded. The arrival of additional performance monitoring information over the next several years should help to define, and hopefully standardize, the most effective design concepts.

Ultimately, however, the growth in the application of sand filters will be constrained by cost and maintenance factors. Continued effort is needed to monitor the operation of sand filters. Such data could yield reductions in the costs of constructing and maintaining filters. If such cost reductions can be realized, sand filters will become an attractive option over a much wider range of development conditions.

—TRS

#### References

Bell, W. and T. Nguyen. 1993. "Structural Best Management Practices for Stormwater Quality in the Ultra-Urban Environment." *Proceedings of the Water Environment Federation 66th Annual Conference*. Volume 7. Surface Water and Ecology 223-234. Anaheim, CA.

City of Alexandria (VA). 1992. "Unconventional BMP Design Criteria." *Alexandria Supplement to the Northern Virginia BMP Handbook*. Dept. of Transportation and Environmental Services. Alexandria, VA.

City of Austin (TX). 1988. "Water Quality Management." *Environmental Criteria Manual*. Environmental and Conservation Services. Austin, TX.

City of Austin (TX), 1990. *Removal Efficiencies of Stormwater Control Structures*. Final Report. Environmental Resource Management Division. Austin, TX. 36 pp.

Ellis, K. 1987. "Slow Sand Filtration as a Technique for the Tertiary Treatment of Municipal Sewage." *Water Resources*. 21(4): 403-410.

Galli, F.J. 1990. *Peat Sand Filters: A Proposed Stormwater Management Practice for Urbanized Areas*. Dept. of Environmental Programs. Metropolitan Washington Council of Governments, Washington, D.C.

Harper, H. and J. Herr. 1992. *Treatment Efficiencies of Detention With Filtration Systems*. Environmental Research and Design, Inc. Orlando, FL. 164pp.

Livingston, E. 1994. Personal communication. Director, Stormwater Management. Florida Dept. of Environmental Regulation.

Newberry, D. 1992. *Management of Urban Riparian Systems for Nitrate Reduction*. Region 5, U.S. EPA. Chicago, IL.

Shaver, E. and R. Baldwin. 1991. *Sand Filter Design for Water Quality Treatment*. Delaware Dept. of Natural Resources and Environmental Control. Dover, DE.

Stewart, W. 1992. *Compost Stormwater Treatment System*. W&H Pacific Consultants. Draft Report. Portland, OR.

Truong, H., C. Burrell, M. Phua and R. Dallas. 1993. *Application of Washington DC Sand Filter for Urban Runoff Control*. Stormwater Management Branch. District of Columbia Environmental Regulation Administration. Washington, D.C.

Tull, L. 1990. *Cost of Sedimentation/Filtration Basins*. 20 June 1990 memorandum. Department of Environment and Conservation Services. Austin, TX.

Urbonas, B. and P. Stahre. 1993. *Stormwater Best Management Practices and Detention for Water Quality, Drainage, and CSO Management*. PTR Prentice Hall. Englewood, NL. 460 pp.

Wegelin, M. 1983. "Roughing Filters as Pre-Treatment for Slow Sand Filtration." *Water Supply*. (1):67-76.

Woodward Clyde Consultants, 1992. *Urban BMP Cost and Effectiveness Data: For 6217(g) Guidance*. U.S. Environmental Protection Agency.



## Further Developments in Sand Filter Technology

*"The design of sand filters is evolving rapidly, and promises to remain a fertile ground for innovation in the years to come. Some experimental approaches will prove successful, while others will doubtless be discarded. The arrival of new monitoring information should help to standardize the most effective design concepts."*

Since these lines were written in *Techniques* in 1994, no less than a dozen research studies have been launched to improve on the performance of the basic sand filter design. These efforts include field and bench studies on a wide array of alternative design configurations and filter media. A few of these efforts have been reported in *Techniques* (see articles 107 and 108), but this large body of emerging research is best assessed as a whole. Towards this end, this article profiles the pollutant removal capability and operational experience reported for this new generation of stormwater filters.

For comparison, it is helpful to begin with a recent performance study of a traditional sedimentation/sand filter monitored by the City of Austin (1997). Known as the Barton Creek Plaza (BCP), this sand filter served just less than three acres of a shopping center parking lot in Austin, Texas, and treated approximately 0.65 watershed-inches of runoff. Stormwater runoff first entered a large sedimentation basin (7,000 cubic feet) before discharging over a sand filter bed (390 square feet). The filter bed was three feet deep, and was composed of 0.02 to 0.04 inch diameter concrete sands. The sand filter was located off-line, and was estimated to bypass about 30% of the annual runoff volume without effective treatment. Three automated samplers were deployed to measure pollutant concentrations entering the sediment basin, leaving the sediment basin, and leaving the sand filter. Nine paired storms were monitored in 1996 and 1997, and the computed removal efficiency is reported in Table 1.

Research findings from the BCP sand filter generally reinforce prior monitoring research on the potential and limitations of traditional sand filter treatment. Generally, the removal of particulate pollutants, such as total suspended solids, trace metals and organic nutrients, was quite high. However, removal rates for soluble pollutants, such as ortho-phosphorus, nitrate-nitro-

gen, and total dissolved solids, were quite low, and sometimes even negative. Removal of bacteria was also quite variable, as evidently the warm, dark and damp environment of the sand filter sometimes served as a source for bacteria. It is interesting to note that much of the observed pollutant removal occurred in the sedimentation basin rather than within the sand filter at the BCP facility (see Table 1), which suggests that both sedimentation and filtration must be combined for optimal treatment. In general, the outflow concentrations from the BCP system were on the low end of those reported for most stormwater treatment practices (see article 65).

The pollutant removal capability of traditional sand filters may not be high or reliable enough for watershed managers that desire higher levels of nutrient or bacteria removal (Glick *et al.*, 1998). Consequently, researchers have had a strong interest in testing whether organic media may be a more effective substitute for sand as a filter medium. In this regard, the use of compost or peat-sand mixes has frequently been proposed.

### *Performance of Peat Sand Filters*

Two peat sand filters were recently tested by the Lower Colorado River Authority (LCRA, 1997). The first system, known as McGregor Park, treated the runoff from a 3.8 acre office parking lot. Before entering the peat sand filter, runoff was pre-treated in a small extended detention pond. The peat sand filter had a surface area of more than 200 square feet, and had a three-foot deep bed, composed of 18 inches of hemic peat over 18 inches of sand, with a layer of calcitic limestone interspersed between. The entire off-line facility was designed to treat the runoff from the first inch of rainfall. A schematic of this peat sand filter design is portrayed in Figure 1.

A second system, known as the underground facility, served a 1.5 acre office parking lot, but had a much different configuration. Runoff first entered an expanded catch basin with a small permanent pool (about 0.05 site-inches of capacity) and floating sorbent pillows for enhanced oil/grease removal. After this initial pretreatment, runoff was then directed into a series of "infiltrator" tubes which spread it over a large but shallow underground filter bed. The bed was about 3,200 square feet in area, and was composed of a mix of hemic peat and sand that was typically only 12 to 18

inches thick. Tom Curran and his colleagues at LCRA sampled more than 20 storms at each of the peat sand filters over a three-year period, and their estimates of its pollutant removal performance are presented in Table 2.

At first glance, removal rates achieved at both peat sand filters were generally comparable to those achieved by traditional sand filters. Removal rates for total nitrogen, total organic carbon and zinc, however, were somewhat higher. It was evident that both peat sand filters were nitrate "leakers." The performance of the underground peat sand filter was reasonably impressive, given that limited pretreatment was provided by the expanded catch basin. The researchers found that the innovative catch basin alone reduced the concentration of most stormwater pollutants by about 10 to 25%.

The McGregor Park peat sand filter was notable in that it recorded reasonably high removal rates for both total and ortho-phosphorus (47% and 57%, respectively), and also had a much higher removal rate for nitrogen (50%) than was customary for a traditional sand filter. Unfortunately, the sampling design did not allow the research team to determine whether the bulk of removal occurred in the extended detention pond or in the peat sand filter bed. Another notable finding from the study was that little, if any, organic carbon leached

from the hemic peat (which is composed of 87% organic carbon, by weight). Removal rates for total organic carbon were not high, but were generally positive (10 to 20%), suggesting that well-aged peat may not become a long-term carbon source in a peat sand filter.

#### *Performance of a Compost Filter*

William Leif (1999) recently monitored two small compost filters used to treat bridge and highway runoff in Everett, Washington. Each compost filter was initially installed in a six by 12 foot precast concrete vault. The first filter served about 0.25 acres of bridge deck and was termed the "deck" filter. The second served about 0.75 acres of road runoff and was termed the "bridge approach" filter. The compost at the bridge approach filter was plagued by clogging, and was ultimately replaced by a canister unit (see Lenhart and Wigginton, 1999). Even with this modification, hydraulic problems were still encountered at the bridge approach compost filter that were thought to be caused by surface algal growth on the filter bed (dry weather flows at the bridge approach filter kept the media continuously moist). As a result, most of the sampling data was collected for the deck filter.

**Table 1: Performance of the Barton Creek Plaza Sedimentation/Sand Filtration System (N=9) (COA, 1997)**

Water Quality Parameter	Mean Outflow Concentration from the BCP System	Removal Efficiency (a)	
		Sed. Basin	System (b)
Total Suspended Solids	32 mg/l	57	89
BOD	4.7 mg/l	33	51
COD	25 mg/l	34	55
TOC	7 mg/l	(-19)	(-4)
Nitrate-N	0.96	3	(-61)
TKN	0.89	33	50
NH3	0.14	7	53
Total Nitrogen	1.83	28	17
Total Phosphorus	0.11	49	59
Dissolved Phosphorus	0.09	23	3
Cadmium	0.49 ug/l	-10	44
Copper	2.9 ug/l	6	72
Lead	2.3 ug/l	34	86
Zinc	22.6 ug/l	48	76
Fecal Coliform	18,528 per 100 ml.	(-63)	(-85)
Fecal Streptococci	2,573 per 100 ml	(-35)	69

(a) EMC method used to compute removal efficiency (b) note that removal rates drop by about 20% if the untreated stormwater bypass is factored in.

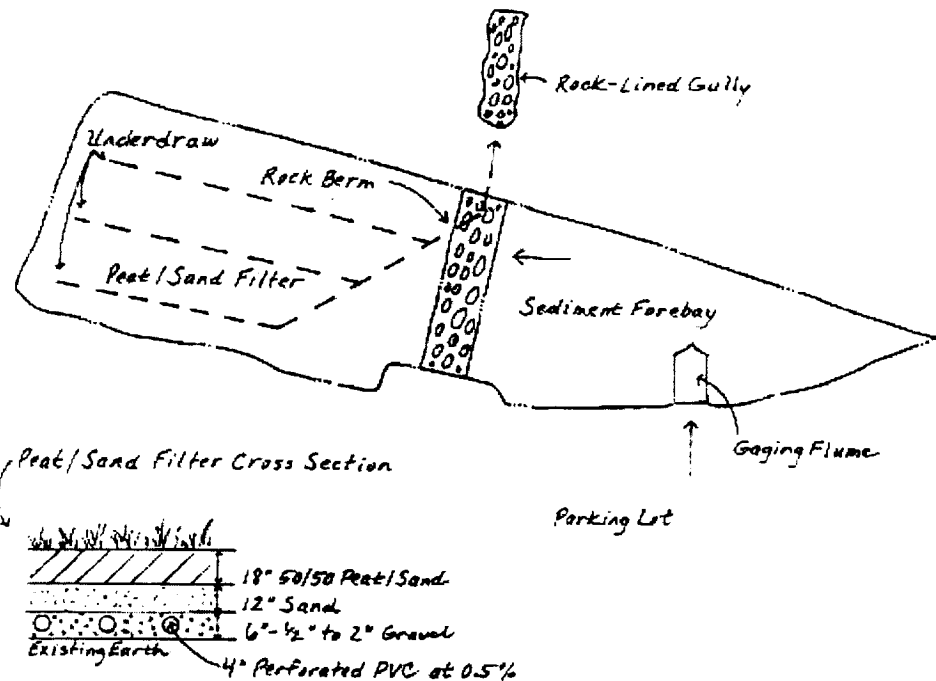

Figure 1: Schematic of the McGregor Park Peat Sand Filter

The pollutant removal performance of the two compost filters was rather modest (see Table 3). For example, removal of total suspended solids was less than 50%, and phosphorus removal was consistently negative. Removal of metals and hydrocarbons was moderate, and the content of these pollutants increased by a factor of two to three within the compost media itself during the course of the monitoring program. The performance of the Everett compost filters was considerably lower than earlier monitoring reports for compost filters (see article 109). The modest performance could have been due to the low inflow concentrations present at the Everett filters, which were clearly on the low end of the range for typical stormwater runoff (see Table 3). In addition, the study design did not measure the pollutant reduction achieved by upstream pretreatment. Clogging, algal growth, and the decomposition of the compost also may have played a role in diminishing the performance of the compost filters.

#### Performance of Other Sand Filter Amendments

Testing of both sand filters and organic filters has generally revealed that they have, at best, a modest capability to remove phosphorus from runoff. Consequently, researchers have evaluated several alternative media specifically intended to boost phosphorus removal in traditional sand filters. The most extensive testing effort so far occurred at the Lakemont stormwater treatment facility in King County, Washington (KCDNR, 1998). The original stormwater facility was constructed to reduce phosphorus loads delivered to

Lake Sammamish from a 253-acre residential catchment. The facility design included two off-line sand filter cells, with runoff pretreatment provided by a wet vault. The sand filter cells were retrofitted to improve phosphorus removal. In the first cell, 55 tons of calcitic limestone were rototilled into the sand filter to create a filter media composed of 90% sand and 10% limestone (by volume). In the second cell, processed steel fiber (PSF, a sort of industrial steel wool) was incorporated into the sand to create a filter media composed of 95% sand and 5% PSF.

Intensive storm monitoring by KCDNR (1998) indicated that both amendments showed some promise in improving the phosphorus removal capability of traditional sand filters. Limited monitoring of the calcitic limestone amendment resulted in 67% removal of total phosphorus (but only 18% of soluble ortho-phosphorus-KCDNR, 1998). Somewhat higher removal was noted for the processed steel fiber amendment. Sampling, which is continuing, indicated that the PSF amendment removed about 68% of the total phosphorus and 50% of the soluble phosphorus. The researchers cautioned, however, that the greater removal must be balanced against the higher cost of the amendments, and their increased tendency to degrade the hydraulic performance of the sand filter over time.

#### Performance of Vertical Sand Filters

Most sand filters are horizontal in that they spread runoff over a uniform bed of sand, which acts as the filter bed. Vertical sand filters take a different approach by directing flows through a vertical sand or gravel sec-



R0079984

tion. The vertical approach is attractive since it sharply reduces the space needed for a filter bed. Skeptics, however, have predicted that vertical sand filters will be subject to poor hydraulic performance, since the lowest layers of the filter are continuously exposed to flows during every storm event and are therefore more prone to clogging.

Sean Tenney and his colleagues at the University of Texas recently tested the feasibility of vertical sand filters in the sensitive Edward's aquifer region of Central Texas. The vertical sand filters (VSFs) were used to treat a few acres of highway runoff, and their basic design is shown in Figure 2. Runoff first enters a hazardous material trap, and then the first half inch of runoff is diverted into a concrete sedimentation basin. The outlet of the basin is a VSF, which consists of two stone-filled baskets or gabions that form a porous barrier supporting the filter media (which initially consisted of a three foot thick layer of medium-sized sand). The VSF filters were designed to completely drain the sedimentation basin within one to two days after a storm. In reality, however, the filters clogged shortly after they were installed. Hydraulic monitoring indicated that sediment basins were still 20 to 50% full two days after storms (see Figure 3). The poor hydraulic performance was caused by clogging at the bottom portion of the sand filter, often along the permeable filter fabric used to hold the sand in place.

The research team then modified the VSF concept by substituting pea gravel for sand as the primary filtering

media. This modification greatly improved the hydraulic performance of the vertical filter, and the sedimentation basins typically drained in five hours or less. The research team then monitored the pollutant removal performance of this new VSF configuration during 10 storm events in 1995, each of which ranged from 0.2 to

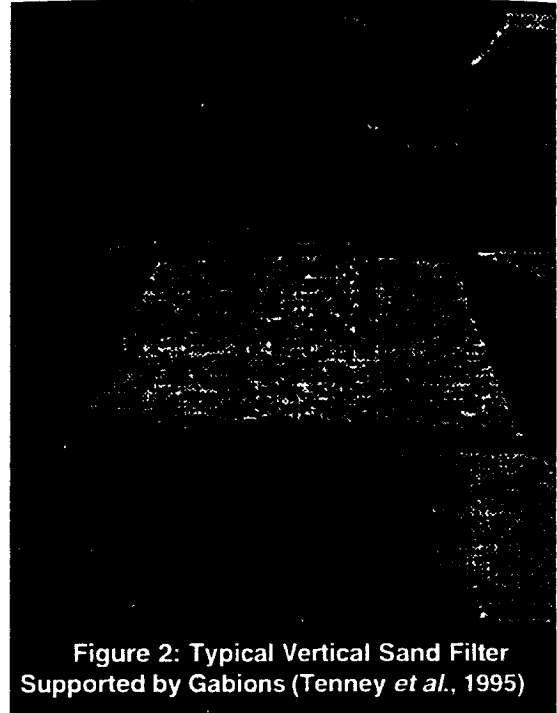

Figure 2: Typical Vertical Sand Filter Supported by Gabions (Tenney *et al.*, 1995)

Table 2: Performance of Two Peat Sand Filter Systems Near Austin Texas (LCRA, 1997)

Water Quality Parameter	The McGregor Park Facility Peat Sand Filter w/ Surface Extended Detention N=21		The Underground Facility Peat Sand Filter w/ Catch basin Pretreatment N=21	
	Outflow EMC (mg/l)	Removal Rate (%)	Outflow EMC (mg/l)	Removal Rate (%)
TSS	6 mg/l	88	12	84
TOC	9.8	18	9.3	11
Total P	0.098	47	0.19	48
Ortho-P	0.013	57	0.071	3
Nitrate-nitrogen	0.55	(-15)	0.56	(-96)
TKN	0.44	61	0.55	61
Total Nitrogen	0.86	51	1.1	30
Total Zinc	0.018	83	0.01	89

Note that removal rates for lead, cadmium and chromium could not be computed because most inflow values were below detection. EMC= event mean concentration, all units in mg/l

**Table 3: Performance of a Compost Filter in the Field  
(Leif, 1999)**

Water Quality Parameter (a)	Median Removal Rate (%)	Median Effluent Concentration
Total Suspended Solids	43	16 mg/l
Total Lead	50	4 ug/l
Total Copper	33	5 ug/l
Total Zinc	29	32 ug/l
Total Phosphorus	-88 (b)	0.06 mg/l
Total Petroleum Hydrocarbons	20 (c)	1.4 mg/l
Chemical Oxygen Demand	37	1.0 mg/l
Fecal Coliforms	"moderate" (d)	about 400 to 500 counts/100ml

Notes: (a) Median removal rates based on ten paired storm samples monitored at both facilities (b) negative removal rates were recorded during all storm events (c) low TPH concentrations in inflow to filter limited performance (d) data could not be fully analyzed because of QA/QC with many microbial samples.

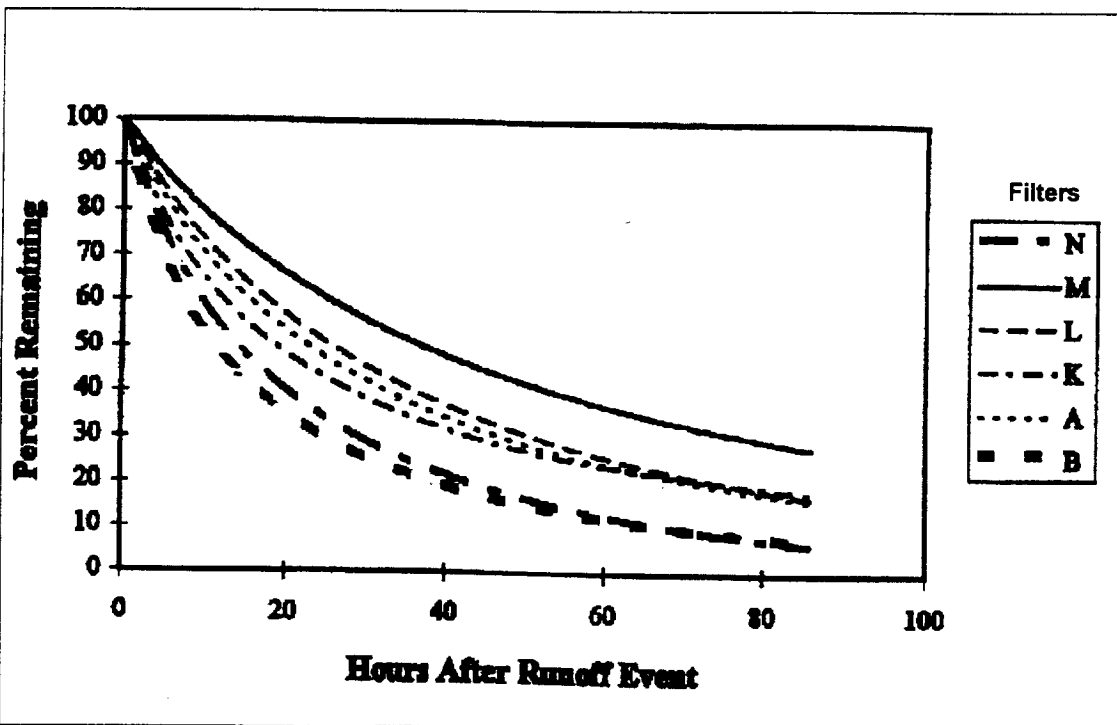

**Figure 3: Hydraulic Performance of Six Vertical Sand Filters in Texas -  
Percent of Runoff Remaining in Sedimentation Chamber as a Function of Time**



R0079986

**Table 4: Performance of a Vertical Gravel Filter**  
(Tenney *et al.*, 1995)

Water Quality Parameter	Mass Reduction (%)
TSS	60
VSS	39
BOD	26
COD	1
Total Carbon	(-48)
Dissolved Carbon	(-101)
Nitrate-N	(-36)
Oil/Grease	18
Chromium	(-28)
Zinc	63
Copper	32
Total Phosphorus	low

1.5 inches in depth. The results can be found in Table 4.

Overall, the removal rates for the vertical gravel filter were rather mediocre—about what would be expected for a poorly designed dry extended pond. Most of the observed removal occurred behind the VSF rather than within it (i.e., pollutants dropped out in sedimentation basin rather than within the gravel filter). Tenney and his colleagues reported that 60% of the sediment and total zinc were trapped behind the filter, with removal of most other pollutants in the 15 to 30% range. Surprisingly, the vertical gravel filter exhibited negative removals for both total and dissolved organic carbon. The team concluded the source of the organic carbon was the decay of leaf litter that had been trapped in the sedimentation basin.

The mediocre performance of the vertical gravel filter was primarily attributed to the short and unreliable detention times achieved by the VSF “outlet.” Given the gabion design, it was very difficult to achieve longer detention times in the sedimentation basin without clogging the VSF filter. The research team concluded that horizontal sand filters are better than vertical sand filters for stormwater quality treatment. However, despite their poor performance, vertical gravel filters may be helpful in creating “dry sedimentation chambers” to pretreat runoff before it enters sand filters or extended detention ponds in arid climates.

#### Testing Alternative Filtering Media in the Laboratory

A number of researchers have investigated the pollutant removal performance of alternative filter media in the laboratory. The typical experimental approach is to fill a three or four foot tall filtering column with the test medium. Each filter column is then periodically dosed with known concentrations of stormwater runoff, either collected in the field or formulated in the lab. The change in pollutant concentration is measured at various depths through the filtering column using special sampling ports. After repeated trials, the overall removal rate is determined based on the change from the initial concentration to the concentration measured at the bottom of the column.

Filtering column studies are quite useful, since they allow researchers to quickly and inexpensively screen many media combinations before they are implemented in the field. These studies not only indicate the pollutant removal potential of various media, but also evaluate how each media affects the hydraulic performance on a filter. To date, researchers have tested a wide variety of possible filtering media, including Brady sand, Zeolites, compost, soil mixes, pea gravel and processed steel fibers. However, when evaluating these studies, it is always important to keep in mind that pollutant removal achieved under controlled lab conditions is usually much higher than that which can be attained in actual field conditions.

Perhaps the most extensive series of filtering column experiments was conducted by Tenney *et al.* (1995). This research team at the University of Texas evaluated a wide range of potential filter media. In their first experiment, they compared the potential removal of “Brady sand” to the concrete sand used in most filters. Brady sand is a well-graded sand mixture in which 80 to 100% of the sand particles are between 0.05 and 0.10 cm. The researchers found little difference in the pollutant removal attained by the two kinds of sand, and reported that the more commonplace concrete sand had a greater hydraulic conductivity.

The team's remaining experiments evaluated the potential of Zeolites and compost as filtering media (Table 5). Zeolites are a naturally occurring mineral, similar in structure to quartz, which has a high cation exchange capacity. Given their high affinity for absorbing pollutants, Zeolites are frequently used to soften and purify home drinking water. In the stormwater filter tests, however, sand filters with Zeolites performed no better than regular sand. Other researchers have reported slightly better results with other Zeolite combinations, particularly in the removal of ortho-phosphorus (Lenhart and Wigginton, 1999).

Tenney *et al.* (1995) also evaluated the feasibility of compost as a filtration medium, and reported mixed results (Table 5). Removal for total suspended solids

and some trace metals was higher than concrete sand, but removal was consistently negative for both nitrate, phosphorus and dissolved carbon. Decomposing compost was thought to be the source of these elevated concentrations in the compost filtering column. On the positive side, the compost filter removed about half of the incoming oil and grease, which was the highest rate achieved by any filter combination tested, and approached TPH removal rates reported for compost canisters in a California parking lot study (Woodward-Clyde, 1998).

HEC (1996) found that filtering columns containing a mix of 95% sand and 5% chopped granular steel wool were capable of consistently achieving a 75 to 85% removal rate for both total and soluble phosphorus.

Surprisingly, few filter column studies have explored the ability of soil mixes to remove stormwater pollutants. Davis *et al.* (1998) recently conducted a series of experiments to evaluate the pollutant removal potential of bioretention filters in Prince George's County, Maryland (Coffman and Winogradoff, 1999). Their experimental apparatus consisted of a 50-square foot box that simulated the dynamics of a bioretention area. The sampling box was 42 inches deep, and consisted of juniper plants rooted in a prepared sandy loam soil, with an inch or two of shredded mulch over the surface.

The large sampling box was dosed with synthetic runoff, and the change in pollutant concentrations was noted with depth. The research team also conducted other experimental trials to see how pH, flow rates, initial concentrations, flow duration, mulch depth and other factors affected pollutant removal.

A second set of experiments was conducted on a 30-inch deep bioretention area in a parking lot that was dosed with synthetic runoff. The results of both bioretention filter experiments are shown in Table 6. As can be seen, the nutrients and metal removal rates were generally quite high in both the lab and field bioretention experiments. The only exception was nitrate-nitrogen, which, as we have seen, is notoriously difficult to remove with any filtration medium.

Clearly, the combination of plants, mulch and sandy loam rivaled or surpassed the nutrient and metal removal rates for other filter media. It is important to keep in mind, however, that the effluent concentrations from the bioretention filters were about the same as other filtration systems. Still, the bioretention filters were found to sequester metals, as the research team documented metal uptake in plants and metal adsorption on the mulch. While further replication is needed, these initial experiments suggest that bioretention filters are quite promising with respect to pollutant removal.

#### *Operational Concerns of Stormwater Filters*

At the same time stormwater managers seek to increase pollutant removal, they also want to maintain the hydraulic performance of the filter. A filtering media that chronically clogs is of little or no value, given that routine maintenance is likely to be the exception rather than the rule in most communities. Several investigators have examined the increased risk of clogging associated with filtering, as measured by sharp drops in hydraulic conductivity. A greater clogging risk was noted in field studies of compost, calcitic limestone, vertical sand and processed steel fibers filters. Some clogging of traditional sand, peat-sand and bioretention

**Table 5: Comparative Removal of Stormwater Pollutants in Experimental Filter Columns (Tenney *et al.*, 1995)**

<b>Water Quality Parameter</b>	<b>Sand</b>	<b>Sand with Zeolites</b>	<b>Compost</b>
Total Suspended Solids	74%	46%	82%
Total Organic Carbon	24	27	12
Oil and Grease	40	21	52
Nitrate-nitrogen	(-66)	(-314)	(-269)
Total Phosphorus	34	26	(-162)
Total Copper	34	13	55
Total Zinc	40	51	75
Total Lead	18	31	26

results are from 16 to 31 doses of actual stormwater runoff through the filtering column

**R0079988**



Table 6: Performance of Soil/Mulch Filter (Bioretention Filter)  
(Davis et al., 1998)

Water Quality Parameter Analyzed	Laboratory Test of Large Bioretention Filter		Field Test of Bioretention Filter	
	% Removal	Outflow Concentration	% Removal	Outflow Concentration
Total Phosphorus	81	0.10	65	0.18
Total Nitrogen	43	1.2	49	2.0
TKN	68	0.9	52	1.7
Ammonia-nitrogen	79	0.5	92	0.22
Nitrate-nitrogen	23	0.26	16	0.33
Copper	93	0.005	97	0.002
Lead	97	<0.002	<95	<0.002
Zinc	96	<0.025	<95	<0.025

Box test was a fifty square foot test bioretention area that had a filtering depth of 3.5 feet; field test was a 2.5 foot deep bioretention area in a parking lot that was dosed with synthetic runoff. Outflow concentrations are in units of mg/l

filters has been anecdotally reported, but does not seem as pervasive as that reported for other filtering media. It is worth noting that the price of a fancier filtering media is usually accompanied by some loss of hydraulic conductivity over time. A stormwater manager can address this issue by either selecting a medium that is less prone to clogging or subjecting the filtering media to less of an hydraulic load (i.e., less depth of flow).

#### *Implications for Stormwater Designers*

When faced with this veritable blizzard of new data, how can stormwater designers decide which kind of sand filter media will best meet their particular stormwater treatment objective? Some initial guidance is offered below, with the proviso that it must be continuously refined to reflect new research findings.

1. The basic sand filter design works well for many small development sites that do not require unusually high pollutant removal requirements. The basic sand filter appears to be capable of removing approximately 80% of incoming sediment, 40% of total phosphorus, and 60% of most metals. In addition, it appears to be quite effective in removing hydrocarbons, which is particularly important for stormwater hotspots. Basic sand filter bacteria-removal performance is mixed, and other practices should be considered when bacteria removal is the prime stormwater treatment objective. Sand filters are also consistent nitrate-leakers, and consequently may not be a wise choice in coastal watersheds where nitrogen removal is a priority. Likewise, designers working in phosphorus-sensitive wa-

tersheds may want to use other media to boost phosphorus removal rates, since sand filters show little ability to remove soluble forms of phosphorus that are most important in reducing eutrophication.

Sand filters also have no ability to remove chlorides or dissolved organic carbon (but then again, few other stormwater practices have much capability in this regard). It is important to bear in mind that the sedimentation chamber is absolutely essential in the basic sand filter design. Sedimentation storage prior to the filter accounts for much of the observed pollutant removal in the system, and helps to reduce the bypass of untreated runoff from these off-line practices.

2. Bioretention areas appear to remove pollutants at a higher rate than basic sand filters, although this conclusion is based on limited monitoring data. Hopefully, future monitoring will demonstrate that the soil filtration of bioretention areas can achieve 60% phosphorus removal and 90% removal of metals and hydrocarbons. More research is needed to confirm whether they also can reliably remove sediment and bacteria, but the soil filtration mechanism used in bioretention should promote high removal rates for these parameters.

3. Organic filter media, such as peat sand and compost, show some promise in removing higher levels of hydrocarbons and metals, and should be seriously considered for hotspot sites. They do not, however, appear to perform much better than basic sand filters when it comes to removing nutrients. Indeed, the gradual decomposition of organic media can result in the export of nitrate and soluble phosphorus. Further monitoring



is needed to determine whether these media have any value in reducing bacteria levels in urban runoff. Lastly, the experience with the Snohomish compost filters clearly indicates that organic filters are a very poor choice if they are likely to encounter dry weather flows.

4. Several media appear to be useful when phosphorus removal is the primary stormwater treatment objective. The evidence shows that soil filtration, whether present in bioretention areas or dry swales, can boost phosphorus removal rates to about 60 or 70%. Incorporating calcitic limestone or processed steel fiber amendments within sand filters also appears to improve phosphorus removal, but it remains to be seen whether the cost and loss of hydraulic performance make it worth the effort. The use of peat sand filters is a third strategy, given that they can remove as much as 50% of total phosphorus, but it should be noted that most of the removal was for organic forms of phosphorus that are not as biologically available. Several media demonstrated little or no ability to boost phosphorus removal rates, including Zeolites, compost and pea gravel.

5. The vertical sand filter concept appears to be fundamentally unsound, as it is prone to chronic and insurmountable clogging problems. However, they may have some value when used as a vertical pea gravel filter, for pretreatment for sand filters or extended detention dry ponds in arid or semiarid climates.

In summary, the current round of research on stormwater filters has yet to discover a "wonder medium," but it has uncovered several media that can provide incremental improvements in overall removal for some pollutants. The next generation of research should focus on the relative value of sand filtration versus soil filtration for stormwater treatment. Such data will be critical in determining whether it makes more sense to continue to try to improve on sand filtration, or simply shift over to practices that utilize soil filtration, such as bioretention.

-TRS

## References

- City of Austin (COA). 1997. "Evaluation of Nonpoint Source Controls— An EPA/TNRCC Section 319 Grant Report." *Water Quality Report COA-ERM-97-04*. Drainage Utility Department. Austin, TX. 130 pp.
- Coffman, L. and D. Winogradoff. 1999. "Bioretention: An Efficient, Cost-Effective Stormwater Management Practice." (pp. 259-264) in *Proceedings of National Conference on Retrofit Opportunities for Water Resource Protection in Urban Environments*. US EPA. Office of Research and Development EPA/625C-99/001. Washington, D.C.
- Davis, A., M. Shokouhian, H. Sharma and C. Minami. 1998. *Optimization of Bioretention for Water Quality and Hydrological Characteristics. Final Report: 01-4-31032*. University of Maryland Department of Civil Engineering, Prince George's County Department of Environmental Resources. Landover, MD. 237 pp.
- Glick, R., G. Chang, and M. Barret. 1998. "Monitoring and Evaluation of Stormwater Quality Control Basins." *Proceedings. Watershed Management: Moving From Theory to Implementation*. Water Environment Federation Speciality Conference. Denver, CO. May 3-6, 1998.
- Herrera Environmental Consultants (HEC). 1996. *Lake Sammamish Phase II Restoration Project. Technical Memo. Pilot Scale Test Results*. Lakemont Park Stormwater Treatment Facility. Submitted to City of Bellevue, WA.
- King County Department of Natural Resources (KCDNR). 1998. *Lake Sammamish Water Quality Management Project. Final Report*. Washington State Department of Ecology. Seattle, WA.
- Leif, W. 1999. *Compost Stormwater Filter Evaluation: Final Report*. Snohomish County Department of Public Works. Surface Water Management Division. Everett, WA. 62 pp.
- Lenhart, J. and B. Wigginton. 1999. "The Stormwater Management Stormfilter." pp 252-258 in *Proceedings of National Conference on Retrofit Opportunities for Water Resource Protection in Urban Environments*. US EPA. Office of Research and Development EPA/625C-99/001. Washington, D.C.
- Lower Colorado River Authority (LCRA). 1997. *Final Report: Innovative Nonpoint Source Pollution Program for Lake Travis in Central Texas*. Prepared for Environmental Protection Agency and the Texas Natural Resource Conservation Committee. Contract No. 1900000019. 60 pp.
- Schueler, T. 1994. "Developments in Sand Filter Technology to Improve Stormwater Runoff Quality." *Watershed Protection Techniques* 1(2): 47-54.
- Tenney, S., M. Barret, J. Malina, R. Charbeneau and G. Ward. 1995. "An Evaluation of Highway Runoff Filtration Systems." *Technical Report No. 265*. Center for Research in Water Resources. University of Texas at Austin. 134 pp.
- Woodward-Clyde, Inc. 1998. *Santa Monica Bay Area Municipal Stormwater/Urban Runoff Pilot Project- Evaluation of Potential Catch Basin Retrofits*. Prepared for City of Santa Monica, CA.

8

R0079990

## Article 107

Technical Note #61 from *Watershed Protection Techniques*, 2(1): 291-293

# Performance of Delaware Sand Filter Assessed

Up to now, our knowledge about the pollutant removal performance of sand filters has been drawn from monitoring data from four filters in Austin, Texas. Some have questioned whether this data is transferable to more humid regions of the country or to other design variations. This gap has been filled by two recent monitoring studies conducted on "Delaware" sand filters in Alexandria, Virginia and Seattle, Washington.

The Delaware sand filter was developed by Shaver and Baldwin (1991) and consists of two parallel trench-like chambers that are installed along the perimeter of a parking lot (Figure 1). Parking lot runoff enters the first chamber, which has a shallow permanent pool of water. The first trench provides pretreatment before the runoff spills into the second trench, which consists of an 18-inch deep sand layer. Runoff is filtered through the sand, and then travels down a gradient to a protected outfall grate. Runoff in excess of the desired water quality treatment volume bypasses both trenches, and does not receive treatment.

An investigative team consisting of Warren Bell, Larry Gavan, and Lucky Stokes monitored a modified Delaware sand filter that collected runoff from a 0.7 acre section of a newly built parking lot located near National

Airport in Alexandria, Virginia (Figure 2). The filter was constructed in 1992, and was about 95 feet long and had a sand filter bed area of 238 square feet (Figure 1). Additional details on its prototype design can be found in City of Alexandria (1995). The pollutant concentration at the inlet and outlet of the filter was monitored over 20 storm events in 1994. An analysis of pollutant concentrations in incoming stormwater indicated that the runoff was within the national ranges established in the National Urban Runoff Program (NURP) study, with two notable exceptions. First, the concentration of organic nitrogen (TKN) was about three times the national average, which was thought to be due to greater local air deposition of this pollutant. Second, total petroleum hydrocarbons were never detected in the parking lot runoff, which is unusual for a such a potential hydrocarbon hotspot. Bell *et al.* speculated that this might be due to the fact that most cars in the private long-term parking lot were newer and more expensive models that are not prone to leakage.

Two similar Delaware sand filters were also monitored by Horner (1995) at a loading facility for a marine terminal in Seattle, Washington in 1994. Horner monitored the removal of sediment, hydrocarbons, phosphorus and metals from these recently constructed facilities. Both studies indicated that the Delaware sand filter had moderate to high ability to remove many pollutants (Table 1). When interpreting the results, it should be kept in mind that each researcher used a slightly different method to calculate removal efficiency. Bell *et al.* computed the total mass of pollutants removed during his study, while Horner reports the average efficiency during all storm events. In either case, the measured removal rates are still quite high.

For example, Bell *et al.* reported mass removal rates for sediment, BOD, total organic carbon, phosphorus and zinc in the 60 to 80% range. In particular, the removal of total and soluble phosphorus were among the highest yet reported for a sand filter. Indeed, the performance would have reached 70% for both parameters if not for an "anaerobic" incident within the sand filter that resulted in possible phosphorus release during four storm events. Mass removal of total nitrogen was 47%, which reflected excellent removal of organic nitrogen (71%) coupled with negative removal soluble nitrate (-53%). This follows a consistent pattern noted for other sand, compost or grass filtering systems, where organic

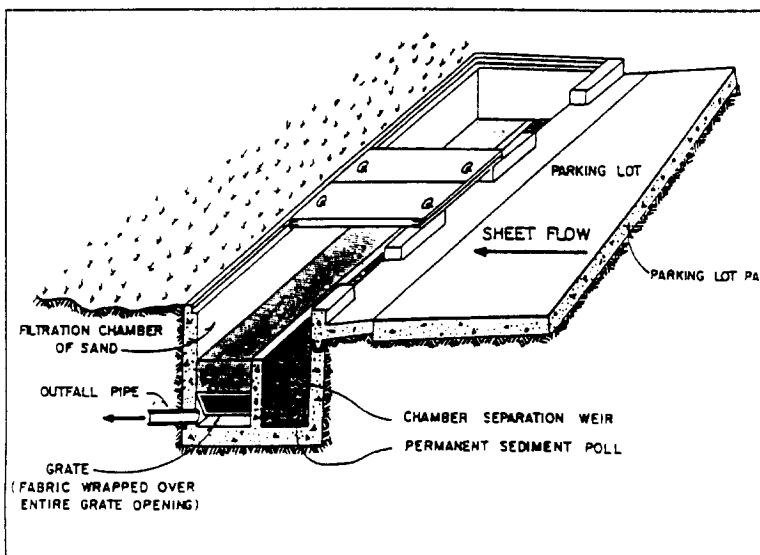

Figure 1: Slotted Curb Delaware Sand Filter (City of Alexandria)

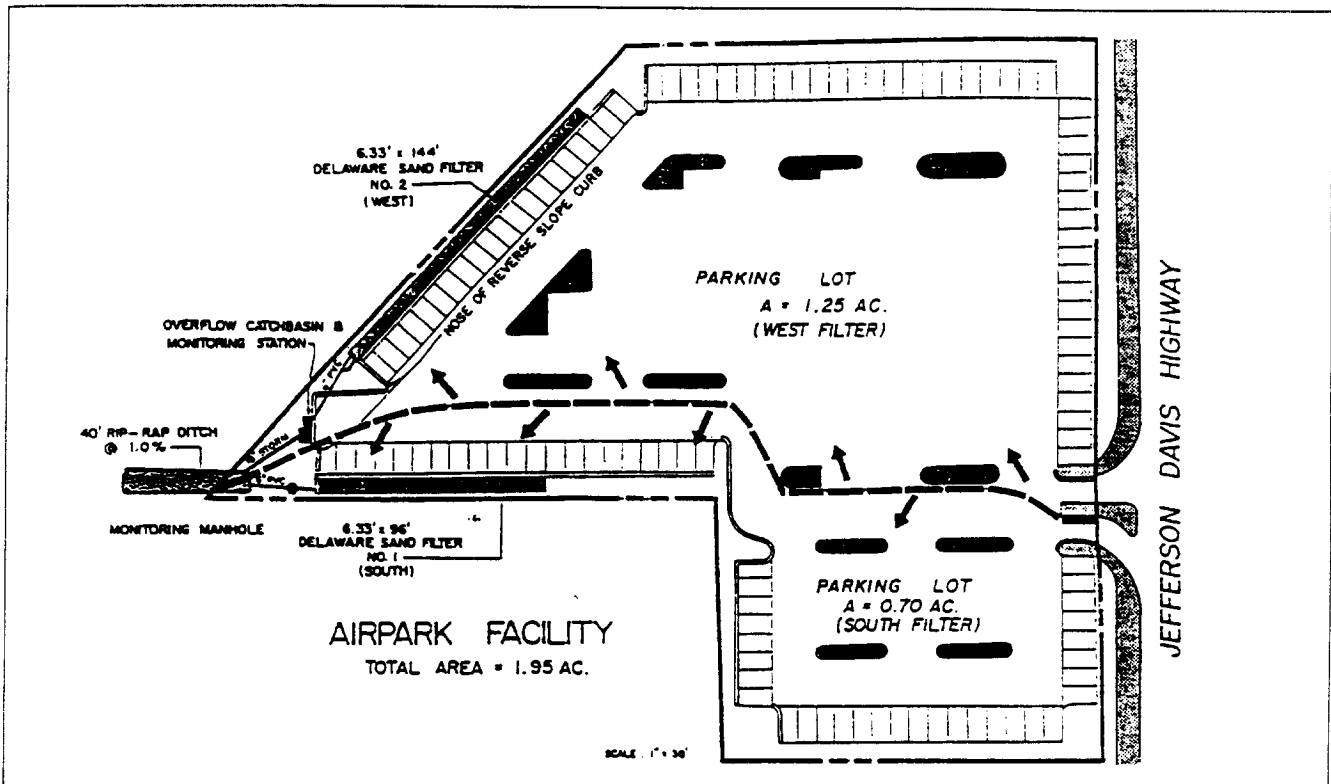

Figure 2: General Layout of AirPark Filters (City of Alexandria drawing)

nitrogen is trapped and partially broken down into ammonia and nitrate through the nitrification process, resulting in a net export of nitrate (i.e., filter conditions or time do not allow for significant denitrification to transform nitrate into nitrogen gas). During the anaerobic incident, the whole filter was probably anaerobic and undergoing denitrification. Pockets of anaerobic activity persisted throughout the study.

Horner reports the first data that indicate how well sand filters remove petroleum hydrocarbons and oil and grease from parking lot runoff. Mean storm removal rates ranged from 55% to 84% in the two filters tested, which does suggest that sand filters can be an effective stormwater management practice for hydrocarbon hotspots. The mean removal rate for phosphorus, zinc and copper was fairly modest in both Seattle sand filters. In most cases, however, removal efficiency climbed as input concentrations increased.

Bell *et al.* conducted a detailed analysis of the concentration-removal phenomena using performance data from Alexandria, Seattle and Texas. He detected a strong relationship between inflow concentration and removal efficiency for sediment, phosphorus, organic nitrogen, zinc, and total petroleum hydrocarbons. Simply put, removal efficiency sharply increased when the concentration of pollutants entering the sand filter is high, and dropped when incoming pollutant concentrations were low (and presumably, much less of a water

Table 1: Comparative Pollutant Removal Performance of Three "Delaware" Sand Filters

	Alexandria, VA (Bell <i>et al.</i> ) Mass removed <sup>a</sup>	Seattle, WA (Horner) Mean removal <sup>b</sup>	Seattle, WA (Horner) Mean removal <sup>b</sup>
No. of Storms Sampled	20	14	6
Total Suspended Solids	79%	83%	8% <sup>c</sup>
Oil and Grease	NA	84%	69%
Petroleum Hydrocarbons	ND	84%	55%
Total Organic Carbon	66%	NA	NA
BOD (five-day)	78%	NA	NA
Total Phosphorus	63% <sup>d</sup>	41%	20%
Ortho-Phosphorus	68% <sup>d</sup>	NA	NA
Total Nitrogen	47%	NA	NA
Nitrate+Nitrite	(-53.3)%	NA	NA
TKN	70.6%	NA	NA
Zinc	91%	33%	69%
Copper	25% (b)	22%	31%

Notes:

- a — Fraction of total incoming pollutant load retained in filter over all storms
- b — Average of storm pollutant concentration reduction, all storms
- c — Poor removal due to very low TSS inflow concentrations ( 4 to 24 mg/l)
- d — Removal rates were higher if four anaerobic events are excluded.
- NA — Parameter not analyzed during monitoring study
- ND — Parameter not detected in runoff during sampling study.

Figure 3: Comparison of Initial TP Concentration vs. TP Removal Efficiency for Sand Filters and Peat-Sand Filters (Bell *et al.* 1995)

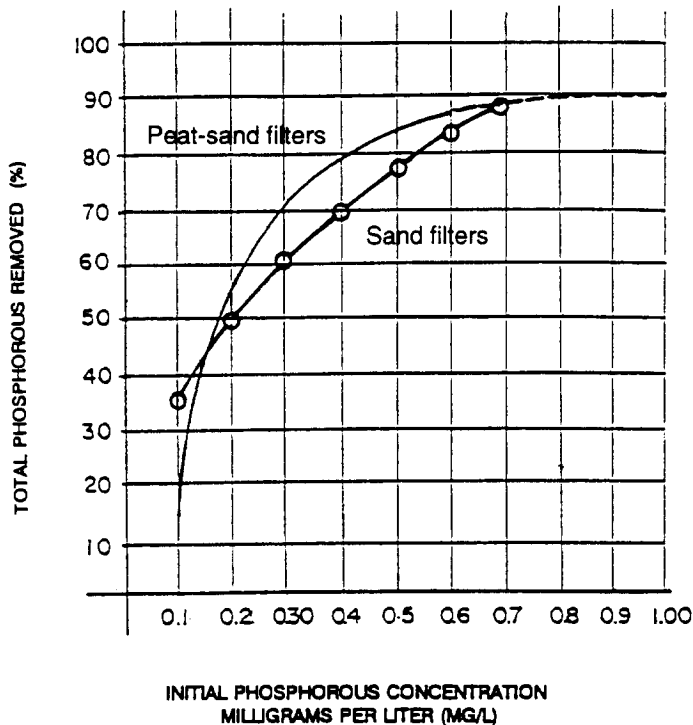

quality problem). Figure 3 illustrates this effect for phosphorus removal.

The new studies provide other insights into the design and operation of sand filters. For example, designers in northern climates have often wondered how sand filters will operate during extended periods of sub-freezing weather. The Alexandria site was subject to an unusual arctic blast that extended for several weeks. Although the wet sedimentation chamber did freeze to a depth of several inches, the sand filter bed still operated reasonably well during the subsequent melt period. Bell *et al.* also analyzed the quality of sediments in the sand filter chamber to determine if they posed a risk for disposal. No priority pollutants were detected in Toxicity Characteristic Leaching Procedure (TCLP) leaching studies of the filter sand, and it was determined that it could be safely landfilled. However, this finding must be tempered by the lack of hydrocarbons in the treated runoff.

Bell's report contains a wealth of useful guidance on how to design better sand filters to remove stormwater pollutants, and some of his key recommendations are summarized in Table 2. Taken together, the two new studies suggest that sand filters can achieve moderate to high pollutant removal rates in humid regions of the country.

—TRS

Table 2: Highlights of Design Improvements for Sand Filters (Bell *et al.*, 1995)

- The sand layer should be designed to have positive drainage through the sand filter to prevent dead spots from becoming anaerobic and releasing previously captured phosphorus. This is best done by capturing filtered water in underdrain pipes.
- Better nitrogen removal may be achieved by placing a foot deep layer of flooded gravel below the sand filter, if sufficient organic carbon is present in runoff. This layer should be covered by a four inch layer of dry gravel to prevent anaerobic conditions from occurring in the sand filter zone.
- Where practicable, sand filters should be designed to exclusively treat runoff from impervious areas. Use on watersheds with less than 70% impervious cover will likely lead to early failure by clogging of the filter pore spaces.

#### References

- Bell, W., L. Stokes, L. J. Gavan., T. N. Nguyen. 1995. *Assessment of the Pollutant Removal Efficiencies of Delaware Sand Filter BMPs*. Department of Transportation and Environmental Services. Alexandria, VA. 140 pp.
- Homer, R. R., and C. R. Homer. 1995. *Design, Construction, and Evaluation of a Sand Filter Stormwater Treatment System*. Part II. Performance monitoring. Report to Alaska Marine Lines, Seattle WA.
- Shaver, E. and R. Baldwin. 1991. *Sand Filter Design for Water Quality Treatment*. Delaware Dept. of Natural Resources and Environmental Control. Dover, DE. 14 pp.

R0079993

## Article 108

Technical Note #100 from *Watershed Protection Techniques*, 2(4): 536-538

# Field Evaluation of a Stormwater Sand Filter

by Ben R. Urbonas, Chief, Urban Drainage and Flood Control District, Colorado

Sand and other media filters are gaining popularity in the United States as stormwater quality treatment practices. A study conducted recently by Denver, Colorado's Urban Drainage and Flood Control District ("the District") investigated the causes of low hydraulic performance of such stormwater filters and the effects on constituent removal. While there is extensive literature on the ability of sand filters to remove pollutants, very little has been reported on long-term hydraulic performance and the myriad of problems stemming from partially or fully clogged filtering practices. Stormwater filters have been widely used in more humid climates recently (Delaware, Virginia, Washington, D.C.) with some degree of success (see articles 105 and 106), but have yet to be tested in more arid or colder climates. How well do they perform under these more severe conditions?

To help answer this question in a field test, the District, in cooperation with the City of Lakewood, Colorado, constructed and installed an underground sand filter to manage a two-acre, mostly impervious,

catchment. Figure 1 shows a perspective of this installation. It consisted of a sedimentation chamber with overflow pipes designed to skim off floatable debris and a sand filter chamber. The sand filter layer was 12 inches in depth and was underlain by a 12-inch gravel layer with underdrain pipes. Flows were measured using a V-notch weir. Discrete flow samples were taken at the inlet, just upstream of the filter and at the filter's outlet pipe. All samples were flow-weight composited to obtain accurate event mean concentrations for each storm. The filter was designed to operate off-line during larger storms, meaning that flow volumes larger than the design treatment capture volume bypassed the filter itself.

### Performance Assessed

The water quality performance characteristics of the District's test sand filter were found to be comparable to those reported in the literature, especially for total suspended solids (U.S. EPA, 1983; Veenhuis *et al.*, 1989; City of Austin, 1990). However, this was true only

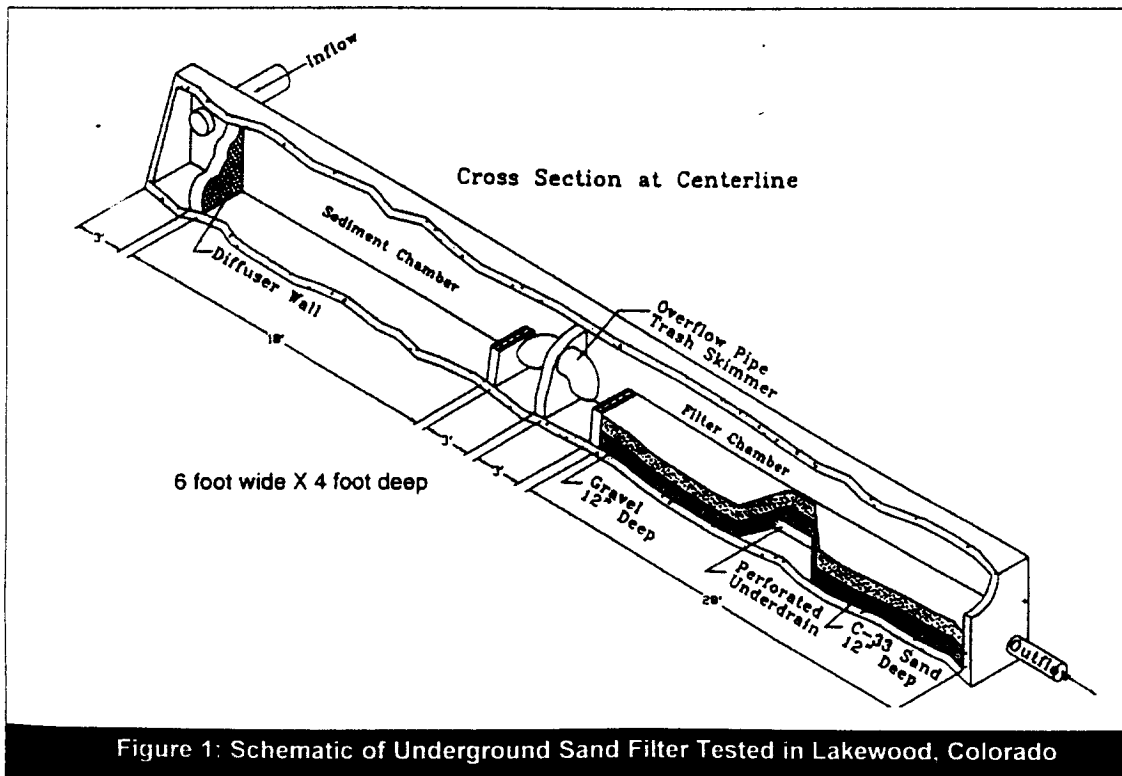

R0079994

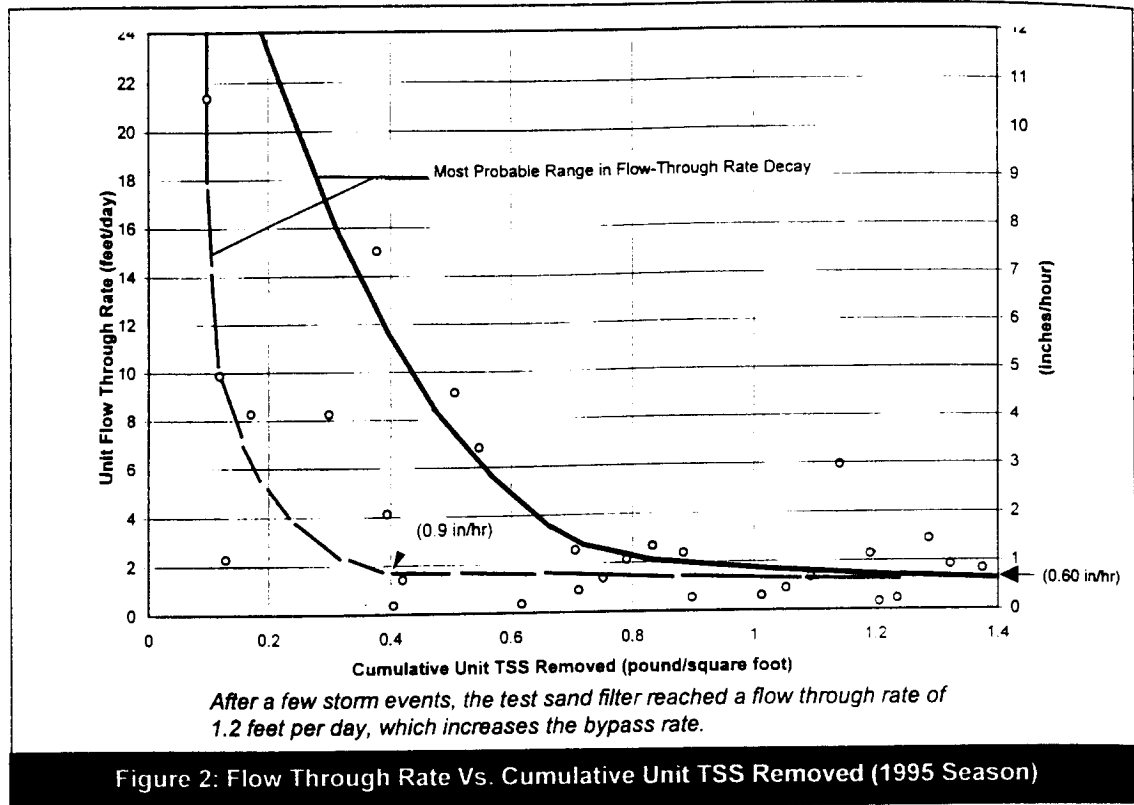

for the fraction of the runoff that actually flowed through the filter. This is not true for all of the runoff that bypassed the filter. As the filter accumulated sediment on its surface, it lost hydraulic conductivity. Figure 2 shows how rapidly the test filter's unit hydraulic flow-through rate (inches per hour) degrades as the TSS load accumulates on each square foot of the filter's surface.

In the Denver field test, immediately after the filter was installed, its flow-through rate was in excess of 24 feet per day. This rapidly diminished to less than 1.8 feet per day after 0.4 to 0.5 pounds of sediment per square foot of filter area had accumulated on its surface (i.e., 0.4 lb./sq. ft. of sediments accumulation is roughly equivalent to a 1/16 inch deep layer). A final flow-through rate of 1.2 feet per day was reached after just a few storms were processed through the filter.

During design, it was expected that at least 70% of all runoff events would be processed through the filter in total, and that some bypass would occur for the other 30% of the larger runoff events. What actually happened during the 1995 summer season was that over 50% of all runoff events exceeded the combined capacity of the filter and the upstream surcharge volume. Because of the large number of flow bypasses, less than 45% of the total TSS measured in the 1995 runoff was removed. This compares to the 85% TSS removal rates reported in the literature.

Although flow bypasses were anticipated, the rate at which the filter clogged and lost hydraulic conduc-

tivity was a surprise. If these findings can be extrapolated to other installations, three design and operation criteria emerge: (1) provide an aggressive maintenance program to keep such filters operating as designed, (2) size filter beds larger than most current designs recommend, and (3) install an adequate stormwater capture volume or detention basin upstream of the filter to balance the flow through rate with the population of storms for which the filter is being designed (Urbonas and Ruzzo, 1986; City of Austin, 1988). These concerns have significant economic and operational consequences and all need to be addressed whenever sand or other media filters are being selected.

#### Comparison to an East Coast Application

Warren Bell and his colleagues (1996) prepared an extensive report on the performance of sand filters in Alexandria, Virginia, that also recorded some bypass flows around filters. This research, however, did not address the fraction of total annual runoff that bypassed the filter. Bell's group primarily field tested the Delaware filter that was originally proposed by Shaver and Baldwin (1991). Bell's findings suggested a longer period for reduced hydraulic performance than was found in the District's test facility, although Bell's data were insufficient to judge if the clogging rates were similar. It is not surprising that the Delaware filters did not clog as rapidly as the Lakewood test site because the inflow concentrations were quite different; the

stormwater entering the Delaware test sites had much lower average event mean concentration of TSS than were found at the Lakewood site (i.e., 60 mg/l vs. 400 mg/l).

The Delaware filter was also larger in proportion to the tributary impervious area and had a larger storage volume above the filter, compared to the Lakewood facility. This suggests that adequately sized filters—those sized with maintenance frequency, appropriate upstream detention volume, and average annual runoff and TSS concentrations in mind—can perform well for longer periods than observed at the Lakewood site.

#### Lessons Learned

Filters can be popular stormwater practices where land area is at a premium, but they need regular maintenance to keep working effectively. Media filters, once clogged, will drain at very slow rates (i.e., falling head of approximately 1.2 feet per day) and stormwater will either pond upstream of the filter or bypass it.

To prevent this problem, it is necessary to properly size a filter for the expected maintenance cycle so that it matches both the average annual runoff volume and the average annual TSS runoff concentration. In order for the filter to keep working throughout the design event without backing up flow when it is partially clogged, the designer has to provide sufficient stormwater capture detention volume upstream of the device to match the filter's clogged flow-through rate. As stated above, it is the capture and treatment percentage of all runoff events that is the real measure of stormwater practice performance, not just the removal efficiency for those storms that do not bypass a facility.

When a media filter is located within an underground vault, it is out of sight and out of mind. Such installations are far less likely to receive needed maintenance than more visible surface facilities. Unless regular inspection programs are in place, there is nothing to insure that the filter will continue to operate properly. A strongly implied lesson from the Lakewood field test is that undersized filters can seal, and, as a result, fail to process through as much volume of runoff as expected.

#### References

- Bell, W., L. Stokes, L.J. Gavan and T.N. Nguyen. 1996. *Assessment of the Pollution Removal Efficiencies of Delaware Sand Filter BMPs*. Dept. of Transportation and Environmental Services. Alexandria, VA. 140 pp.
- City of Austin. 1988. *Environmental Criteria Manual*. Environmental and Conservation Services. Austin, TX.
- City of Austin. 1990. *Removal Efficiencies of Stormwater Control Structures*. Final Report. Environmental Resource Management Division. Austin, TX. 36 pp.
- Shaver, E. and R. Baldwin. 1991. *Sand Filter Design for Water Quality Treatment*. Delaware Department of Natural Resources and Environmental Control. Dover, DE.
- Urbonas, B. R., and W. Ruzzo. 1986. "Standardization of Detention Pond Design for Phosphorus Removal." *Urban Runoff Pollution*, NATO ASI Series Vol. G10, Springer-Verlag, Berlin.
- U.S. EPA. 1983. *Results of the Nationwide Urban Runoff Program, Final Report*. U.S. Environmental Protection Agency, NTIS PB84-18552, Washington D.C.
- Veenhuis, J. E., J. H. Parish, and M. E. Jennings. 1989. "Monitoring and Design of Stormwater Control Basin." *Design of Urban Runoff Quality Controls*. American Society of Civil Engineers. New York, NY.

## Article 109

Technical Note #3 from *Watershed Protection Techniques*, 1(1): 13-14

# Innovative Leaf Compost System Used to Filter Runoff in Northwest

The use of organic media to filter out stormwater pollutants appears to be a promising direction for urban stormwater management practices. An example is the leaf compost system developed by W&H Pacific in Portland, Oregon. About 30 compost systems have been installed in the Pacific Northwest to treat runoff from small sites. Performance data on a prototype of the compost treatment system has recently become available.

The basic design of the system is shown in Figure 1. Runoff enters a forebay, and then passes into a series of compost treatment cells. Each cell contains a one-foot depth of compost, followed by a filter fabric, a six-inch layer of small diameter rock, and two inches of pea gravel. Runoff filters through the compost and is then collected by a perforated pipe and directed toward the outlet. The slope from the inlet to the outlet of the 100-foot long filter bed is 2% and requires about three feet of head. Like most stormwater filtering systems, the

filter bed and subsoils are separated by an impermeable polyliner.

The filter system served a 74-acre mixed-residential watershed, and was sized to provide 200 square feet of surface area per cfs of incoming flow. The local target for runoff treatment is to capture one-third of the two year design flow. This roughly translates to about 0.10 watershed-inches of storage, assuming a 2.25 gpm/ft<sup>2</sup> rate for the first 30 minutes of runoff.

The key to good performance is proper selection of compost. A suitable compost has the following characteristics:

- Mature (i.e., organic matter no longer rapidly degrades)
- Hemic
- Low contaminant levels
- High permeability
- Locally obtainable at a reasonable cost

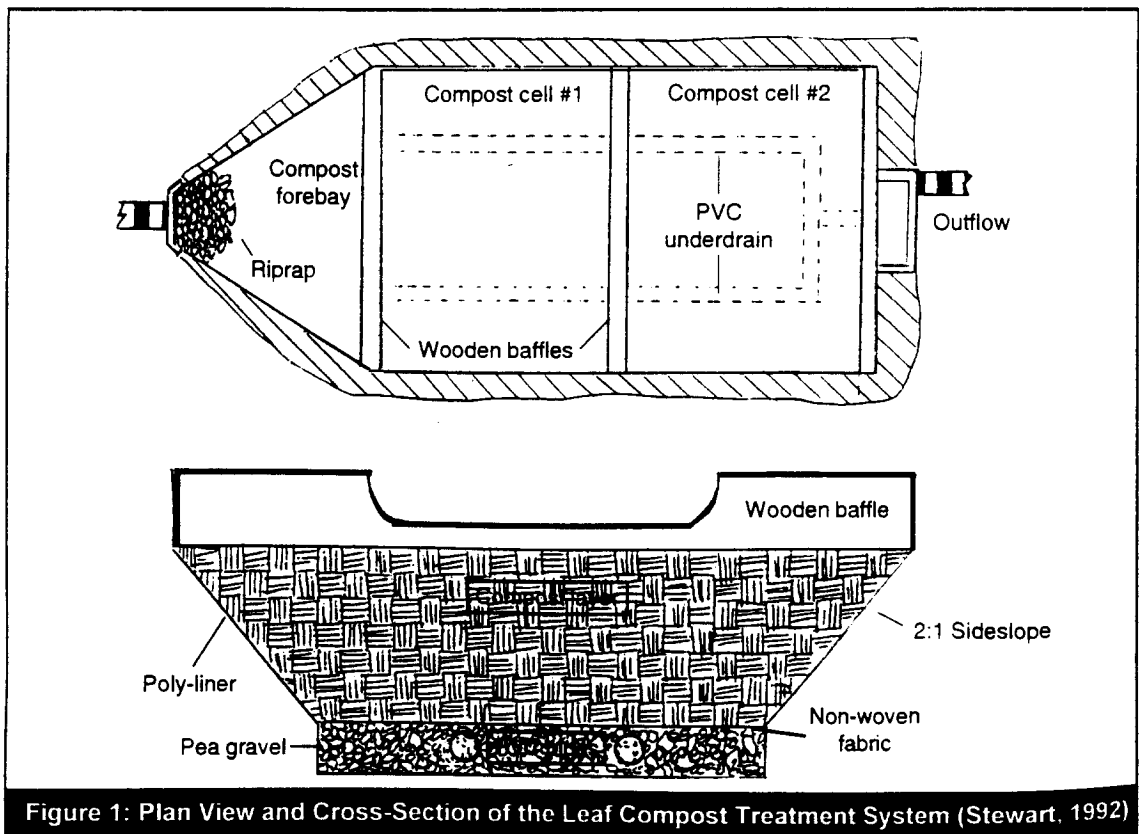



After extensive testing, the authors selected leaf compost as the ideal medium. It was available from a city compost system at about \$10.00 per cubic yard. In contrast, compost derived from yard wastes met many of these criteria, but failed leaching tests.

The pollutant removal performance of the prototype was computed based on flow composite monitoring of seven storm events (Table 1). The system provides excellent removal of sediment, particulate nutrients, organic carbon, hydrocarbons and some heavy metals. Total dissolved solids, however, increase after passing through the compost filter, which appears to reflect the exchange and/or leaching of cations within the compost. Similarly, while particulate nutrient forms are trapped within the compost, the system exports soluble forms of nutrients, such as nitrate and soluble phosphorus. Subsequent monitoring in 1992 has confirmed that these removal rates can be equalled or exceeded. In general, the compost system was most effective during the first flush of runoff and in smaller storms, with removal rates declining as storm size increased. Better removal rates can probably be attained by increasing either the surface area or storage volume of the compost system.

The compost system requires annual or biennial removal and disposal of the compost layer, followed by replacement with fresh compost. This routine maintenance operation can cost the owner several thousand dollars. Early tests indicate that the used compost can be safely landfilled. A few operational problems have been encountered with the compost system. The key problem has been sediment deposition over the surface of the compost bed that reduces the permeability rate. Perhaps the use of larger forebays, lower design perme-

**Table 1: Pollutant Removal Performance of Leaf Compost Filter (Stewart, 1992)**

Pollutant	Percent Removed
Total Suspended Solids	95
Total Dissolved Solids	-37
COD	67
Total Phosphorus	41
Soluble Phosphorus	(negative)
Organic Nitrogen	56
Nitrate	-34
Cadmium	N.D.
Lead	N.D.
Zinc	88
Hydrocarbons	87
Chromium	61
Copper	67
Boron, Calcium, Potassium, Magnesium, Sodium	(negative)

ability rates, or regular raking/discing of the filter bed surface could relieve the problem. W&H Pacific are continuing to refine the design to increase its effectiveness.

—TRS

**Reference**

Stewart, W. 1992. *Compost Stormwater Treatment System*. W&H Pacific Consultants. Draft Report. Portland, OR.



R0079998

# Bioretention as a Stormwater Treatment Practice

by Susan D. Bitter and J. Keith Bowers, *Biohabitats, Towson, MD*

To respond to the need for better stormwater practices in small commercial areas, the Prince George's County Department of Environmental Protection (DEP) sponsored a research project to design innovative practices based on the concept of *bioretention*. Bioretention is an innovative urban stormwater practice that uses native forest ecosystems and landscape processes to enhance stormwater quality. Bioretention areas capture sheet flow from impervious areas and treat the stormwater using a combination of microbial soil processes, infiltration, evapotranspiration, and plants.

In 1993, Biohabitats, Inc. and Engineering Technologies Associates (ETA) tested the bioretention concept and developed a practical manual to provide initial guidance in the design, preparation, and maintenance of experimental bioretention areas. The feasibility study included extensive research to develop specifications for the design of bioretention areas. Areas of research included soil absorption capacities and rates, plant absorption capacities and rates, water budgets, pollutant removal potential, and maintenance requirements.

The feasibility study assessed the use of bioretention practices for sites containing large areas of impervious surfaces typical of suburban and urban development in Prince George's County. The case study analysis assessed bioretention practices for three commercial sites and one residential site. Bioretention areas were then designed using the guidelines developed during the feasibility analysis and included grading requirements, soil amendments, plant material selection, maintenance requirements, and evaluation procedures to determine pollutant removal effectiveness.

The analyses demonstrated that bioretention practices can be feasible and economical alternatives for providing treatment of the first half-inch of stormwater runoff from most impervious surfaces. In addition, it was found that bioretention may be an economically feasible alternative to other stormwater practices and offers benefits of improved aesthetics and minimal environmental impact.

## How Bioretention Works

Bioretention areas are designed to be used in urban and suburban areas as off-line systems which treat the

first flush of runoff from impervious surfaces (Figure 1). Median strips and parking lot islands are two prime areas where bioretention can be successfully applied to enhance stormwater runoff quality.

Bioretention works by directing stormwater runoff from the parking lot to a bioretention area as sheet flow or concentrated flow. Depending on site conditions, runoff may be guided into bioretention areas directly from an impervious surface or through a grass filter strip/swale. Using a grass buffer strip will reduce velocities and filter particulates from the runoff.

Runoff is then directed over a sand trench that separates the planting bed from the impervious surface. The sand trench augments the infiltration capacity of the planting bed, slows the velocity and evenly distributes incoming runoff, and facilitates the flushing of pollutants from the surrounding soil.

Once the sand trench reaches its infiltration capacity, runoff is directed into the planting bed. The planting bed is graded to pond runoff to a depth of six inches, allowing time for the ponded water to infiltrate through the organic topsoil/sub-soil and evaporate on the surface. Infiltrated runoff is stored in the planting soil where it may exfiltrate into the underlying subsoils in the bioretention area.

The organic topsoil layer provides a medium in which microorganisms degrade petroleum-based solvents and other hydrocarbons. The planting soil is designed to facilitate plant growth, infiltrate runoff, and absorb heavy metals, nutrients, and hydrocarbons.

The use of plant material in bioretention areas is modeled after the properties of a terrestrial forest community ecosystem. The terrestrial forest community was selected based on its documented ability to cycle and assimilate nutrients, pollutants, and metals through the interactions among plants, soil, and the organic layer. These components are the major elements of the bioretention concept. Specific plant species are selected based on their ability to assimilate pollutant runoff and tolerate urban stress, variable soil moisture regimes, and ponding fluctuations. A list of landscaping materials that meet these requirements can be found in a design manual produced by the Prince George's County DEP (1993).

R0079999

R0080000

Figure 1: Schematic of a Bioretention Area Serving a Parking Lot (PGDEP, 1993)

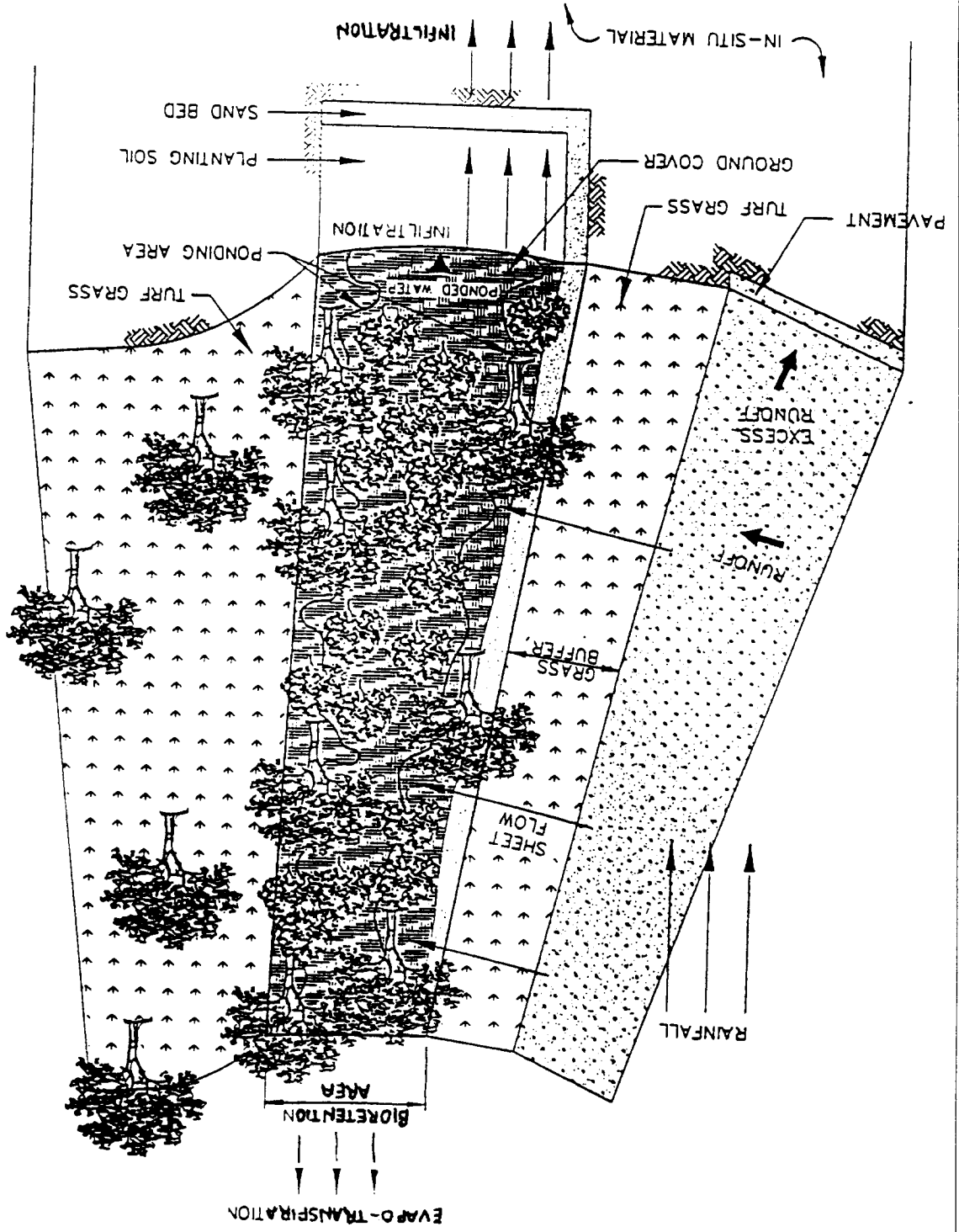

8

When designing bioretention areas, the following criteria need to be considered:

- Size of the drainage area to be treated
- Location of the bioretention areas
- Sizing guidelines
- Calculating water budgets and nutrient removal capabilities
- Grading and elevations
- Soil amendments
- Organic layer/mulch amendments
- Planting concept
- Plant species selection
- Surrounding land use and land cover
- Number and sizing of plant material
- Planting design
- Plant growth and soil fertility
- Maintenance

Bioretention areas also provide other benefits including the creation of shade and wind breaks, noise absorption, albedo reduction, creation of micro-habitats, and improved aesthetics. The primary application is for commercial parking lots. In many cases a bioretention area can be located within the required landscaping or open space in a commercial parking lot.

#### Reference

Prince George's County Dept. of Environmental Protection. 1993. *Design Manual for Use of Bioretention in Stormwater Management*. Landover, MD.

**Table 1: Key Specifications for Bioretention Area (BA) Design  
(Prince George's County DEP, 1993)**

Bioretention design element	Specification
Minimum width of BA	15 to 25 feet
Minimum length of BA	40 feet
Maximum ponding depth	6 inches
Minimum planting soil depth	4 feet
Maximum drainage area to BA	0.25 to 1 acre
Maximum slope within BA	20%
Maximum entry velocity	3 feet/second
BA as Percent of Total Site Area (100% imperv.)	5 to 7%
BA Landscaping, Trees and Shrub species	3 each
BA Landscaping, Plant Materials (Tolerant of pollution, ponding and periodic drying)	Tolerant species from approved list
Shredded Hardwood Mulch layer	3 inches
Planting Soil Texture (No more than 25% clay content)	sandy loam, loamy sand, or loam
Sand layer (bottom and one-side)	1 foot

## Multi-Chamber Treatment Train Developed for Stormwater Hot Spots

Stormwater runoff from paved urban "hot spots," particularly automotive service and repair stations, can contain pollutant concentrations three to 600 times greater than those found in other urban sources. The higher potential for heavy stormwater pollutant loading becomes apparent when one also considers the multitude of potential hot spots located throughout urban areas (Table 1). This being the case, it becomes prudent to treat a relatively small amount of runoff at the source as opposed to allowing contaminated runoff to become part of a much larger volume that may or may not be effectively treated at the end of the pipe.

Effective, on-site treatment of stormwater hot spots has been a problem for several reasons. First, most hot spots tend to be small in size and lack adequate space for the installation of typical stormwater management practices such as ponds and wetlands. Second, the use of gravitational settling as a sole pollutant removal mechanism does not provide sufficient hot spot pollutant removal. Third, infiltration is not an option due to risks of groundwater contamination. Lastly, the traditional underground approaches using oil grit separators have not been reported to be effective (Schueler, 1994).

To help solve the hot spot treatment problem, Robert Pitt and his colleagues at the University of Alabama-Birmingham have developed and tested a

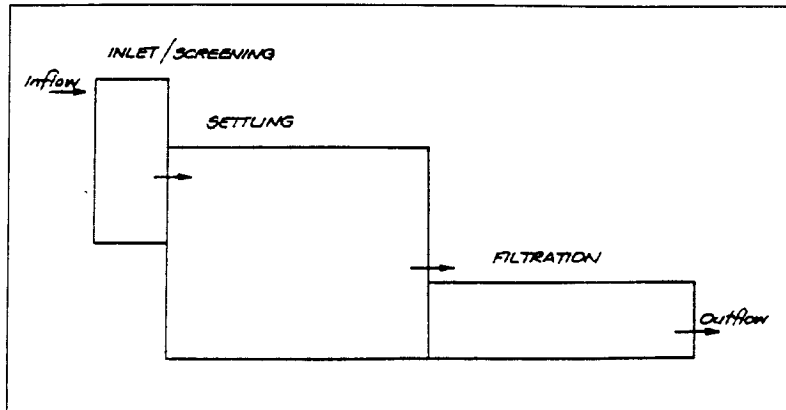

Figure 1: Three Main Chambers of the MCTT

prototype known as the multi-chambered treatment train (MCTT). This device employs screening in the first chamber, settling in the next, and filtration in the last (Figure 1). It is designed for underground use. It can be sized to contain runoff from various rain events and typically requires between 0.5 and 1.5% of the paved drainage area. Present information places construction costs of the MCTT ranging from \$10,000 to \$20,000 per one-quarter acre of drainage area, assuming use and availability of prefabricated units (Pitt, personal com-

Table 1: Potential Stormwater Hot Spots (Schueler, 1994)

- Commercial nursery
- Auto recycle facilities
- Commercial parking lots
- Fueling stations
- Fleet storage areas
- Industrial rooftops
- Marinas
- Outdoor container storage of liquids
- Outdoor loading/unloading facilities
- Public works storage areas
- SARA Title III Section 312 hazmat generators (if containers are exposed to rainfall)
- Vehicle service and maintenance areas
- Vehicle and equipment washing/steam cleaning facilities

Table 2: Specialized Components of the MCTT

Chamber	Component	Description	Function
Inlet	flash aerator	small column packing balls with counter current air flow	removes volatile pollutants and traps trash
	catch basin sump	conventional catch basin sump	traps grit and sand-size particles
Settling	sorbent pads	floating absorbent pads	traps oil and grease
	fine bubble aerator	generator powered fish farm aeration stone	enhances aeration
	inclined tube or plate settlers	plastic tubes 2" x 2", inclined 30-45 degrees, arranged in rows of opposing direction	increases surfaces area of settling chamber, enhances sedimentation and prevents scour
Filtration	Gunderboom™ filter fabric	covers top of filter	reduces channelization, slows infiltration, sorbs oils
	peat/sand filter media	50/50 mix, at least 12" depth	removes small and dissolved particles, provides ion exchange
	filter fabric	separates peat/sand layer from gravel and pipe layer	prevents gravel layer from clogging
	gravel packed under drain	perforated PVC pipe and gravel	provides additional filtration/outlet

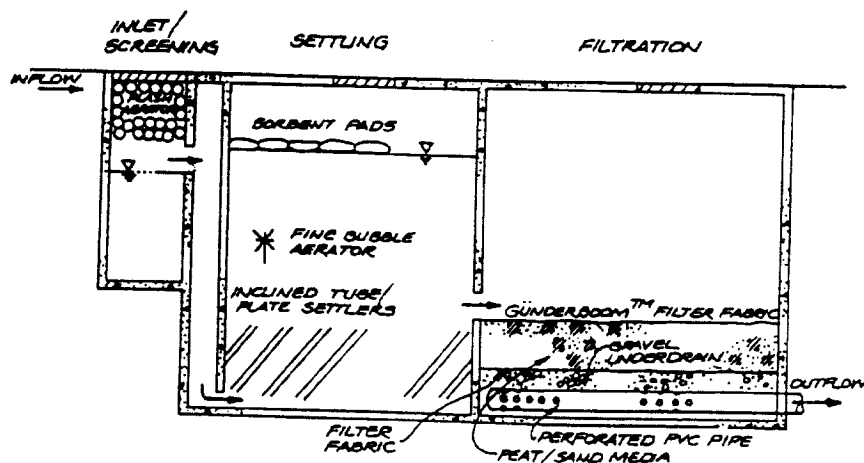

The multi-chamber treatment train (MCTT) consists of three treatment units in sequence—an inlet screening chamber, a sedimentation chamber and a filtration chamber. Most of the pollutant removal occurs in the last two chambers.

Figure 2: Detailed Schematic of the MCTT

munication, 1997). Additional data on operation and maintenance costs of the MCTT is currently being collected.

The MCTT is divided into three main chambers (Figure 2). Stormwater enters the first chamber where the largest particulates settle out and the bulk of highly volatile materials are removed when they pass over a flash aerator (additional, innovative components within each chamber are listed in Table 2). The stormwater then either flows under gravity or is pumped into the settling chamber. Here, settling of fine sediment is enhanced through the use of inclined tube or plate settlers while floating hydrocarbons and additional volatile compounds are removed by sorbent pads and bubble diffusers. Next, the stormwater flows, or is pumped slowly into, the filtration chamber containing a sand and peat filter bed for final removal of dissolved toxicants. The filter also functions in the partial treatment of runoff that may have bypassed prior chambers in the event of excess stormwater flow. To ensure that the water volume is distributed evenly over the filter bed, a fabric covers the top.

The size of this device varies according to the climatic conditions of the geographic region being served. Parameters considered include rainfall amount, intensity, and elapsed time between storms as well as suspended sediment load and desired maintenance regime. Pitt has developed a computer model to aid in the site-specific design.

A pilot-scale MCTT was constructed by Pitt on the campus of the University of Alabama-Birmingham. This device, designed to catch runoff from a vehicle service area and parking facility, was tested over a six-month monitoring period from May to October of 1994. Two additional full-scale units have since been constructed in Wisconsin for testing how this technology functions in a colder climate. Preliminary pollutant removal data from the Wisconsin site is presented in Table 4.

Preliminary performance results of the pilot-scale MCTT for 13 storm events indicate substantial reductions of total suspended solids, heavy metals, and both dissolved and suspended stormwater toxicity from the unit overall (Table 3). Toxicity values were obtained using the Microtox™ screen that analyzes specific toxins in both dissolved and suspended forms. This test not only detects nonconventional pollutants in stormwater, but establishes a standard by which to measure their "treatability."

Of notable significance is the inlet chamber where screening occurs. Screening has little effect on pollutant removal (virtually none) but serves an important role in trapping large materials, thereby reducing problematic maintenance concerns throughout the device and enhancing the ability of other chambers to remove pollutants.

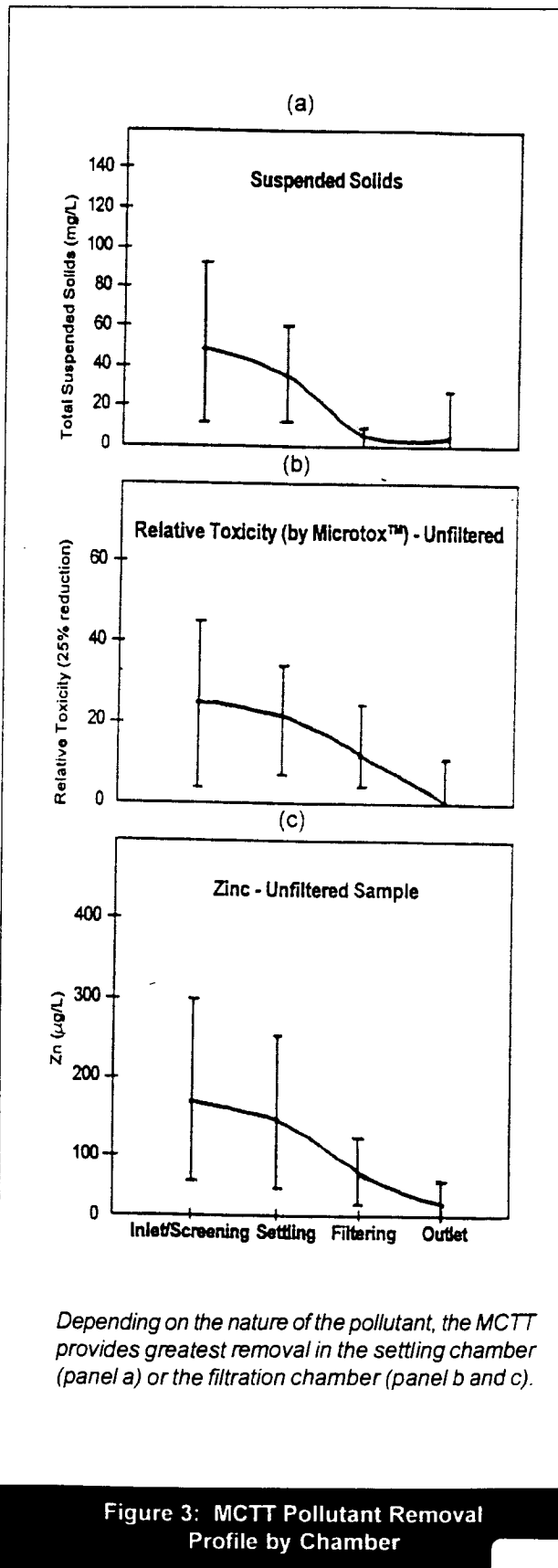

R0080004

**Table 3: Prototype (Alabama) MCTT Pollutant Removal Efficiency Rates Based on Concentration Changes from Inflow to Outflow**

Pollutant	Screening Chamber	Settling Chamber	Filtration Chamber	Overall Performance
TSS	nsd*	91	-44	83
Turbidity	(some reduction)	50	-150	40
COD	nsd	56	-24	60
Nitrate	nsd	27	-5	14
Ammonia	nsd	-155	-7	-400
Phosphate	nsd	nsd	1c	-
Toxicity (suspended)	nsd	18	70	96
Toxicity (dissolved)	nsd	64	43	98
Lead	nsd	89	38	100
Zinc	nsd	39	62	91
n-Nitro-di-n-propylamine	nsd	82	100	100
Pyrene	nsd	100	NA	100
bis (2-ethylhexy) phthalate	nsd	99	-190	99

\*nsd = inflow and outflow concentrations were not significantly different at the 0.05 level

The settling chamber was responsible for most of the pollutant reductions in suspended solids, lead, zinc, polycyclic aromatic hydrocarbons (PAHs), turbidity, COD and to a lesser degree, nitrate and toxicity. The filter chamber provided additional removal of most toxicity and heavy metals. Ammonia nitrogen was increased by several times and nitrate-nitrogen had a very low removal rate. However, this finding is to be expected given the anaerobic nature of the filter system.

Preliminary monitoring data from two full-scale applications of the MCTT in Wisconsin appear to confirm that it can achieve consistently high removal for solids, nutrients, metals and two PAHs (see Table 4). The Wisconsin test sites involved a similar design that treated stormwater runoff from a quarter-acre maintenance yard and a newly paved parking lot.

Based on the initial monitoring of the prototype and full-scale system, it appears that the design provides superior performance to conventional sand filter systems (see Table 4), which is reasonable considering that the sand filters employ much less sophisticated measures for screening, settling and filtration.

Pitt's study design was arranged to isolate the relative contribution of each of the three chambers—screening, settling and filtration—to the overall pollutant removal of the system (Figure 3). Pitt found that the importance of each chamber depended on the type of pollutant entering the system. For example, suspended pollutants were removed quite efficiently using just the settling process, whereas the filtration chamber was responsible for further reduction of those same pollut-

ants as well as the additional removal of dissolved pollutants. Suspended solids were reduced somewhat by screening but were almost totally reduced by settling, while filtration was of no consequence (Figure 3, panel a).

Toxicity was basically unaffected by screening, received slight treatment in the settling chamber, but was reduced significantly by filtration. This comparison is a clear illustration of the relative importance of settling versus filtration for certain types of pollutants. As shown in panel c of Figure 3, screening accomplished in the inlet chamber only achieved negligible zinc reductions. Pollutant removal was attained through settling followed by more extensive removal from filtration.

Further analysis of MCTT pollutant removal capabilities may be obtained through testing the efficiencies of the innovative components within each chamber and the effects they have on improving and enhancing the three processes of screening, settling and filtration. Given variable climates and pollutant concentrations present at hotspots, a full application of the MCTT may only be needed when a very high level of treatment is desired.

—TJL



**Table 4: Preliminary Pollutant Removal Efficiency for Two Full-Scale Multi-Chamber Treatment Train (MCTT) Systems in Wisconsin**

	<b>Ruby Street MCTT<sup>1</sup></b>	<b>Minoqua MCTT<sup>2</sup></b>	<b>Sand Filters Mean<sup>3</sup></b>
No. of Storms <sup>4</sup>	5-6	7	226
Pollutant Removal (%)			
Suspended Solids	98	85	85
Total Phosphorous	84	80	50
Total Zinc	93	90	71
Total Copper	89	65	43
Flouranthene	92	>90	no data
Pyrene	>80	>75	no data

- <sup>1</sup> Full-scale MCTT installed in Ruby Street Garage in Milwaukee, Wisconsin, that treats runoff from a maintenance garage (drainage are 0.25 acres). Pollutant removal computed on a total load basis. (Data from Greb *et al.*, 1998).
- <sup>2</sup> Full-scale MCTT installed at 2.5 acre new commercial parking lot. Pollutant removal computed on median EMC removal method. Data from Pitt (1996).
- <sup>3</sup> Mean removal efficiency of 12 independent monitoring studies analyzed in Claytor and Schueler (1996).
- <sup>4</sup> Number of paired storm events sampled.

**References**

Claytor, R.A., and T. Schueler. 1996. *Design of Stormwater Filtering Systems*. Center for Watershed Protection. Prepared for the Chesapeake Research Consortium. 250 pp.

Greb, S. S. Corsi and R. Waschbusch. 1998. *Evaluation of Stormceptor and Multi-Chamber Treatment Train as Urban Retrofit Strategies*. Presented at Retrofit Opportunities for Water Resource Protection in Urban Environments, A National Conference. The Westin Hotel. Chicago, IL. February 10-12, 1998.

Pitt, R., M. ASCE. 1996. *The Control of Toxicants at Critical Source Areas*. The University of Alabama at Birmingham. 22 pp. Paper presented at the ASCE/Engineering Foundation Conference, August 1996, at Snowbird, Utah.

Pitt, R., M. 1997. Personal Communication. Professor of Civil Engineering, the University of Alabama-Birmingham.

Schueler, T. 1994. "Hydrocarbon Hotspots in the Urban Landscape - Can They Be Controlled?" *Watershed Protection Techniques* 1(1): 1-5.





# Channels & Swales

R0080008



# Performance of Biofilters in the Pacific Northwest

**W**hat exactly is a biofilter? Some would say it is a grassed swale with class. More technically, it is a swale that is explicitly designed to treat stormwater rather than just conveying it along. In the last few years, our knowledge about biofilters has increased as a result of research from the Pacific Northwest.

Local governments in the Puget Sound region of Washington have turned to biofilters as cost-effective methods to treat urban stormwater runoff. They are passive, technically simple, and flexible methods of treating runoff in developing areas. Biofiltration is a process where stormwater is treated by contact with vegetation and soil surfaces along a long and broad grass swale. A cooperative team of researchers from several cities and universities has investigated the performance of biofilters over the last few years. In addition, the researchers have gathered field data to define some of the most critical variables for the design of biofilters.

The biofilter design process relies on an adaptation of Manning's formula of open channel flow for the six month, 24-hour design storm, using an iterative process constrained by a specified maximum velocity and slope. Manning's formula for open channel flow expresses the relationship among all of the principal biofilter design variables, with the exception of biofilter length. It is frequently expressed as follows:

$$Q = (1.49/n) * A * R^{0.67} * s^{0.5}, \text{ where}$$

Q = the volumetric flow rate, ft<sup>3</sup>/s

n = Manning's coefficient, accounting for boundary friction

A = cross-sectional area, ft<sup>2</sup>

R = hydraulic radius, the ratio of cross-sectional area to wetted perimeter, ft

s = channel slope (ft vertical/ft horizontal)

Horner *et al.* (1988) have developed an iterative biofilter design procedure based on the capacity of the biofilter during the water quality design event and the stability (erosion potential) of the biofilter during more extreme events. Key design variables in Horner's procedure include the Manning's *n* value, swale shape, maximum flow velocity for the design storm, and residence time in the biofilter (Seattle Metro, 1992).

To determine the pollutant removal performance of a typical biofilter, the City of Mountlake Terrace (Washington) constructed a test 200-foot long biofilter. The geometry of the trapezoidal biofilter was as follows: 4% average slope, five-foot bottom width, and 3:1 (h:v) sideslopes. Average residence time for runoff within the biofilter was computed to be just under 10 minutes. The biofilter was about two years old, and was mowed twice a year. The biofilter served a comparatively large 15.5 acre watershed, consisting of single family and multi-family residential homes, parks, and a major arterial road. Total imperviousness in the contributing watershed was approximately 47%.

During the second phase of the study, the upper 100 feet of the test biofilter was piped, thereby effectively reducing its length by half. This modification enabled the researchers to test the performance of biofilters designed for a shorter length and corresponding residence times (about five minutes).

Runoff inflow and outflow from the 200-foot configuration was monitored during six storm events in the summer and fall of 1991. An additional six flow-weighted composite samples were collected from the shorter 100-foot biofilter in the fall and winter of 1992. Removal rates were computed based on the change in pollutant concentration occurring between the inflow and outflow from the biofilter. Consequently, the sampling method did not measure the possible reduction in pollutant loads due to runoff infiltration within the biofilter itself. Infiltration, however, was very minor. The swale was on a glacial till not far below the surface, and the upper soil layer was observed to saturate rapidly (<1 hour) after the onset of a storm.

The 200 foot long biofilter was found to be reasonably effective in removing many pollutants contained in urban stormwater (Table 1). In general, high rates of removal were reported for sediment, hydrocarbons, and particulate trace metals, but nutrient removal was very modest. Less than 30% of the total phosphorus entering the biofilter was removed, and the biofilter actually was a net exporter of nitrate. More encouraging removal rates were observed for biologically available phosphorus forms. Surprisingly, the biofilter tended to increase the level of fecal coliform bacteria as runoff passed through it. This increase was thought to be due to pet droppings and possible bacterial multiplication within the biofilter itself.



**Table 1: Pollutant Removal Performance of 100- and 200-Foot Biofilters, N=6 (Seattle Metro, 1992)**

Pollutant	100 foot biofilter (%)	200 foot biofilter (%)
Suspended Sediment	60	83
Turbidity	60	65
TPH (Hydrocarbons)	49	75
Total Zinc	16	63
Dissolved Zinc	negative	30
Total Lead	15	67
Total Aluminum	16	63
Total Copper	2	46
Total Phosphorus	45	29
Bioavailable P	72	40
Nitrate-N	negative	negative
Bacteria	negative	negative

As might be expected, the 100-foot long biofilter did not perform as well as the longer version, although clear statistical differences were only noted for two pollutants. Removal rates for the shorter biofilter were also more inconsistent (higher standard deviation). The one exception to this pattern was the moderate to high removal observed for various forms of phosphorus. This result, however, may be a sampling artifact, as the greater removal rates occurred during storms that produced very low phosphorus concentrations at the inflow point.

Based on the monitoring study, the research team concluded that a five to 10 minute residence time in a minimum 100-foot long biofilter would ensure reliable pollutant removal, particularly for storms with significant rainfall peaks.

The project site also allowed the researchers to compute detailed measurements of actual Manning's *n* values under typical biofilter conditions. Three independent methods were used to measure velocity of flow, and a range of *n* values were computed for the biofilter (from 0.192 to 0.198, when it had been mowed to a height of six inches). Generally, the value of *n* did not vary with small changes in slope, but did vary with flow rate. The research team recommended a standard Manning's *n* value of at least 0.20 for stormwater biofilter design. Unmowed, taller grasses were computed to have higher Manning's *n* values during high flow events (approximately 0.24).

One of the frequently cited concerns about biofilters involves how well they are constructed and maintained in the field. Horner and his colleagues (1988) surveyed the condition of 44 biofilters in the field. The study

**Table 2: Field Survey of the Condition of Biofilters, N=44 (Horner et al., 1988)**

Characteristics	Percent of biofilters sampled
<u>Vegetative type</u>	
Natural grass	27
Grass seed mix	41
Emergent wetlands	30
<u>Vegetative cover</u>	
Full	59
Some bare spots	30
Poor	11
<u>Dry weather flow</u>	
Dry	36
Standing water	38
Running water	17
<u>Inlet Type</u>	
Curb cut	18
Culvert pipe	63
Unchannelled	18
Soil infiltration rate high	18
200 feet or longer	66
Slope less than 2%	86
Had check dams	6
<u>Sideslopes</u>	
Gentle	30
Steep	70
Had been regularly mowed	41
Had been maintained	50
<u>Cross-sectional shape</u>	
Trapezoidal	33
Parabolic	50

indicated that there clearly was plenty of room to improve in both areas (Table 2). For example, about four in 10 biofilters did not have the dense grass cover necessary to achieve effective filtration. Similarly, only 40% of all biofilters were dry during the summer months—the remainder had standing or running water. A high proportion of the biofilters could be referred to as "biocanyons," as they had sideslopes in excess of 3:1 (h:v). Nearly all the biofilters that received runoff from curb cuts had significant sediment deposition at the edge of the biofilter that could impede the entry of runoff into the system. Most significantly, less than half

of all biofilters had ever been maintained after they were constructed. Periodic grass mowing was the maintenance activity performed most often (41%).

Based on both the monitoring and field experience, the research team has suggested refined design criteria to improve the performance of biofilters, which are summarized in Table 3. The biofilter does appear to be a promising technique to treat the quality of urban stormwater, but will require future improvements in design, maintenance and landscaping. One particular design improvement would be to place more biofilters off-line. In this event, they would only treat runoff from the water quality design storm, but would bypass larger storm events that produce greater runoff depths, are more erosive and could possibly mobilize pollutants trapped in biofilter soils.

—ER

## References

- Horner, R. et al. 1988. *Biofiltration Systems for Storm Runoff Water Quality Control*. Washington Dept. of Ecology. 84 pp.
- Seattle Metro and Washington Ecology. 1992. *Biofiltration Swale Performance: Recommendations, and Design Considerations*. Publication No. 657. Washington Dept. of Ecology. 220 pp.

**Table 3: Key Biofilter Design Criteria**

- **Geometry**  
Preferred geometry minimizes sharp corners and has gentle slopes, parabolic or trapezoidal shapes, with sideslopes no greater than 3:1 (h:v).
- **Longitudinal slope**  
Should be in the range of 2 to 4%. Checkdams should be installed if slopes exceed 4% and underdrains installed if slopes are less than 2%.
- **Swale width**  
Should be limited to no more than 8 feet, unless structural measures are used to ensure uniform spread of flow.
- **Maximum residence time**  
Try to achieve a hydraulic residence time for the 6 month 24 hour storm of about 9 or 10 minutes.
- **Maximum runoff velocity**  
No more than 0.9 fps for 6 month, 24 hour storm, and no more than 1.5 fps for 2 year storm event.
- **Mannings n value**  
Recommend the use of a 0.20 value in design
- **Mowing**  
Routine mowing is used to keep grass in active growth phase, and to maintain dense cover.
- **Grass height**  
Normal grass height should be at least two inches above design flow depth.
- **Biofilter Soils**  
A sandy loam topsoil layer, with an organic matter content of 10 to 20%, and no more than 20% clay. If soil test indicates that the current soil does not meet these criteria, a surface layer topsoil amendment may be used.
- **Water table**  
Designer should check to determine the level of the seasonally high water table. If it is within a foot of the bottom of the biofilter, it may be advisable to select wetland species.
- **Plant selection**  
Select grass species that produces a uniform cover of fine-hardy vegetation that can withstand the prevailing moisture condition. Wetland adapted species such as *Juncus* and *Scirpus* may be utilized if drainage is poor.
- **Landscaping**  
Other plant material can be integrated into a biofilter; but care should be taken to prevent shading or leaf fall into swale.
- **Construction**  
Use of manure mulching or high fertilizer hydroseeding to establish ground cover should be avoided during construction, as these can result in nutrient export.

00

R0080012

# Runoff and Groundwater Dynamics of Two Swales in Florida

One of the most detailed assessments of the performance of grassed swales was conducted by Harvey Harper (1988) in Central Florida. The monitoring study looked at the changes in the quality of surface water, groundwater and sediments as runoff passed through two 200-foot-long swales draining an interstate highway.

While equal in length, the two swale systems were remarkably different in character (Table 1). For example, the "wet swale" was constructed at about the same elevation as the water table, and consequently the surface of the swale system was ponded with at least a few inches of water throughout the year. As a result, wetland plants, such as pickerelweed, water pennywort, and panic grass, grew well across its entire length. The infiltration rate of the wet swale was effectively zero. Therefore, the major pollutant removal processes operating in the wet swale were settling and vegetative filtering. In many respects, it was more comparable to a pocket wetland than a grassed swale.

The water table was at least two feet below the surface of the "dry swale." This swale had very sandy soils with an extremely high infiltration rate of 13.6 inches/hour. Only a rather sparse cover of annual weeds and grasses became established in the dry swale, even though it had been constructed some 16 years ago. Even so, it was estimated that at least 80% of the incoming runoff to the swale infiltrated into the swale before it reached the outlet. The dry swale also had a gentle slope, and a residence time approximately five times longer than the wet swale. The key pollutant removal process operating within the swale was infiltration of runoff into groundwater, and some sedimentation.

The comparative pollutant mass removal of each swale is depicted in Table 2. Both the wet swale and the dry swale were very effective in removing particulate pollutants contained in highway runoff. However, the nutrient removal capability of the wet swale was rather modest (total nitrogen 40%, total phosphorus 19%). Negative pollutant removal (or export) was noted for dissolved orthophosphate and ammonia. The wet swale also removed most trace metals at rates ranging from 30 to 90%. It should be noted, however, that the dissolved or soluble fractions of the metals were not removed as readily as the particulate fraction (see Table 3). More than 50% of the metals were found in soluble form at the outflow from the swale. It is speculated that the sandy, low organic matter soils did not provide many binding sites to capture soluble metals as they passed through the swale.

The dry swale was the best performer in removing pollutants, with mass reduction rates of 70% or greater for all parameters sampled. Much of the load reduction could be attributed to the infiltration of runoff into the soil of the dry swale. The effect of the swale in reducing pollutant concentrations of runoff that actually reached the outflow sampling point, however, was much less pronounced (Table 3). In fact, the wet swale consistently outperformed the dry swale in reducing the concentration of pollutants that traveled the entire length of the swale. The sparse vegetative cover in the dry swale apparently was not as effective in filtering runoff.

Groundwater and sediment sampling were conducted at both sites to determine the fate of pollutants that had been trapped in the swale. The monitoring

**Table 1: A Tale of Two Swales—Comparative Attributes of Two Swales Monitored by Harper (1988) in Central Florida**

Characteristic	Wet Swale	Dry Swale
Swale length	70 meters	70 meters
Underlying soils	sandy soils, < 5% silt clay	sandy soils < 5% silt/clay
Infiltration rate	effectively zero	13.4 inches/hour
Groundwater depth	0 to 2 ft above	2 ft below surface
Vegetation	wetland plants	sparse grass/weeds
Sideslopes	3 to 1 (h:v)	6 to 1 (h:v)
Longitudinal slope	1.8%	0.7%
Age of swale	23 years	16 years
Drainage area	1.17 acres	0.83 acres
Imperviousness	100%	70%
Time of concentration	9 minutes	45 minutes
Storms monitored	11 events	16 events
Groundwater interactions	groundwater moves into swale; creates shallow ponding	80% of runoff infiltrates through swale



indicated that most trace metals were indeed trapped in the upper five centimeters of swale soils, and did not migrate into nearby groundwater. Soluble nutrients, on the other hand, did move into groundwater, particularly at the dry swale site. Overall, however, both swales had only a modest impact on the quality of adjacent groundwater.

The two swales occupy two ends of a continuum of infiltration conditions that can occur within swale systems, ranging from zero to almost unlimited infiltration. Significantly, both swales in this low relief environment were at least moderately effective in removing pollutants in urban stormwater. The swales did have some similarities: neither had dense grass turf nor silty or clay soils that might have provided better exchange sites.

Harpers's study provides further evidence of the value of long swales in treating urban stormwater, and indicates the importance of the water table in designing swales in sandy, low-relief environments.

—TRS

#### Reference

Harper, H. 1988. *Effects of Stormwater Management Systems on Groundwater Quality*. Final Report. Environmental Research and Design, Inc. Prepared for Florida Dept. of Environmental Regulation. 460 pp.

**Table 2: Comparative Pollutant Removal Performance of Two Swale Systems (Percent Pollutant Mass Removed)**

Pollutant	Wet Swale (%)	Dry Swale (%)
Suspended solids	81	87
BOD (five day)	48	69
Total nitrogen	40	84
Total Phosphorus	17	83
Nitrate-N	52	80
Organic nitrogen	39	86
Ammonia	(-11)	78
Ortho-phosphorus	(-30)	70
Cadmium	42	89
Copper	56	89
Chromium	37	88
Lead	50	90
Nickel	32	88
Zinc	69	90

**Table 3: Mean Concentration Reduction Through Two Grassed Swale Systems in Central FL**

Water quality parameter	Concentration reduction (%)		Outflow concentration	
	Wet swale	Dry swale	Wet swale	Dry swale
Suspended solids	81	59	6.4 mg/l	28 mg/l
Dissolved solids	3	(-3)	114 mg/l	91 mg/l
Total nitrogen	40	21	0.96 mg/l	1.7 mg/l
Total phosphorus	17	13	0.19 mg/l	0.5 mg/l
Nitrate-N	52	(-2)	0.19 mg/l	0.5 mg/l
Ammonia-N	(-11)	(-8)	0.10 mg/l	0.15 mg/l
Ortho-phosphorus	(-30)	(-48)	0.08 mg/l	0.24 mg/l
Chlorides	(-110)	0	21 mg/l	8 mg/l
Cadmium	41	51	5 µg/l	4 µg/l
Copper	56	54	17 µg/l	36 µg/l
Chromium	37	60	8 µg/l	8 µg/l
Lead	50	49	112 µg/l	705 µg/l
Zinc	69	51	53 µg/l	140 µg/l
Nickel	31	60	32 µg/l	11 µg/l



R0080014

## Performance of Grassed Swales Along East Coast Highways

**H**ighways are a unique form of development in that their impervious lanes span many miles, frequently crossing both large and small drainage divides. For many highway engineers, the preferred option for runoff treatment involves the use of long grassed swales, located in a narrow right-of-way parallel to the highway or within the median strip. Grassed swales are cheap to construct, easy to maintain, and are often needed anyway to convey excess stormwater runoff off the road. How effective are they in removing the many pollutants that wash off road surfaces?

To address this question, Dorman and his colleagues (1989) evaluated the performance of three highway swale systems in Florida, Maryland and Virginia. They measured flows and pollutant concentrations through three different swales that were each about 200 feet in length. The three swales that were selected spanned a wide range of conditions encountered along highways: slopes (one to 5%), soil types (sandy to silt loam), vegetative cover (good to poor) and age (five to 20 years—see Table 1). In addition, they monitored the concentration of metals and nutrients within swale soils to determine if pollutants were accumulating over time. In another related study, a research team lead by Shaw Yu (1993) has been monitoring the pollutant removal capability of a 300-foot-long highway swale in Virginia.

Despite the fact that the swales were of equal length, their reported removal rates were quite different (Table 2). As might be expected, the Florida swale exhibited the best overall removal capability. High removal rates for sediment (98%) organic carbon (64%) and nitrogen (45 to 48%) are often expected at sites with low slope, sandy soils, and dense grass cover. Monitored phosphorus removal (18%) was on the low range reported for grassed swales and biofilter systems, but metal removal usually exceeded 50 to 70%.

The Maryland swale occupied the other end of the performance spectrum. The swale had a moderate slope (3.2%), but had poor grass cover and was prone to erosion. Although the sampling was limited (four storm events), the swale was found to export sediment and nitrate and demonstrated little capability to remove organic nitrogen, organic carbon, or total phosphorus. Metal removal rates were mixed, with high rates reported for cadmium, and low rates for copper, lead and zinc.

While the Virginia swale had the highest average slope (4.7%), it had better vegetative cover and experienced only minor erosion. Consequently, it exhibited moderate performance in removing highway pollutants. Removal of sediment and organic carbon exceeded 65%, and total phosphorus was reduced by 41% (the highest total phosphorus removal of any swale monitored by Dorman). On the other hand, removals of organic nitrogen, nitrate and metals were on the low end of the range reported for other swale systems.

Dorman and his colleagues also found that trace metals accumulated over time in each of the three swale soils, which corroborates that these pollutants are being removed. Nutrients, on the other hand, showed a mixed pattern, with roughly half of the samples showing evidence of nutrient accumulation in swale sediments, and the remainder showing either no change or a decrease in sediment concentration. The analysis could not determine if the lack of nutrient accumulation in some of the test sites was due to re-suspension and "spiralling" out of the swale. Another interesting finding relates to the longevity of highway swales. Two out of the three swale systems were eventually eliminated as a result of construction to add more highway lanes.

Yu's monitoring of another Virginia highway swale is not yet complete, but a preliminary assessment after four storms showed that the swale removed 68% of sediment and 60% of total phosphorus. The higher removal rate could be due to the greater length of the swale, and the presence of a checkdam. Yu indicates that many swales tend to exhibit a curious hydraulic behavior. During small storm events, much less flow was recorded at the bottom of the swale than at the top of the swale (presumably reflecting the infiltration of runoff as it passes along the swale soils). In some small storms, no measurable flow was detected at the swale outlet.

In contrast, during large and intense storms, more runoff was measured at the bottom of the swale than at the top (probably because of additional runoff inputs that come down the side-slopes of the swale). This finding suggests that swale removal rates may be underestimated during smaller storms because some fraction of the incoming runoff infiltrates into swale soils.

Each of the four monitored swale systems described here were originally intended merely to convey storm-

water runoff. Their dimensions and capacity were designed solely to accommodate the peak discharge of the 10-year, 24-hour storm event in a non-erosive manner (about six to eight inches of rain, depending on the location of the study site). Unlike the biofilter, the standard highway swale is not explicitly designed for the smaller storm events (0.2 to 1.2 inches of rain) that produce the majority of annual runoff that passes through the swale.

In summary, the studies show that the length of a highway swale alone is not a reliable measure of its future performance. Other factors, such as slope, soil type, and grass density appear to be very important. Since many of these variables cannot be controlled or assured over the long term, the highway designer should consider a more "structural" swale design. In this approach, a series of water quality design elements are incorporated along the length of swale systems, such as underdrains, checkdams, sand layers, diversions to off-line swales or pocket wetlands. These elements should result in improvement in both the rate and reliability of a swale's long term pollutant removal capability.

—TRS

#### References

- Dorman, M., J. Hartigan, J. Steg and T. Quaserbarth. 1989. *Retention/Detention and Overland Flow for Pollutant Removal From Highway Stormwater Runoff. Vol. I. Research Report.* Federal Highway Administration. FHWA/RD-89/202. 202 pp.
- Yu, S., S. Barnes and V. Gerde. 1993. *Testing of Best Management Practices for Controlling Highway Runoff.* Virginia Transportation Research Council. FHWA/VA-93-R16. 60 pp.

Table 1: Summary of Site Characteristics of the Three Highway Swale Systems Studied by Dorman *et al.*, 1989

Variables	Virginia	Maryland	Florida
Length	185 ft	193 ft	185 ft
Area served	1.27 ac	1.27 ac	0.56 ac
Impervious	67%	64%	63%
Slope	4.7%	3.2%	1%
Cover	Poor	Poor	Good
Erosion	Moderate	Severe	None
Soil type	Silt loam	Silt loam	Sandy
Age	20 years	ND	5 years

Table 2: Monitored Pollutant Removal Performance of Three Highway Swale Systems (Dorman *et al.*, 1989)

Swale site	Virginia	Maryland	Florida
Storms sampled	9	4	8
Sediment	65	(-85)	98
Organic carbon	76	23	64
TKN	17	9	48
Nitrate	11	(-143)	45
Total P	41	12	18
Cadmium	12-98	85-91	29-45
Chromium	12-16	22-72	51-61
Copper	28	14	62-67
Lead	41-55	18-92	67-94
Zinc	49	47	81

Removal rates computed as % long term mass reduction, based on the assumption that inflow and outflow runoff volumes were equivalent. Range in metal removal rates reflect uncertainty in concentration due to detection limit problems.



# Pollutant Removal Pathways in Florida Swales

**G** rass swales are essentially living filters and are thought to be an ideal practice for treating the quality of stormwater runoff. The shallow flow of runoff through grass blades and across soils should provide optimum conditions for pollutant removal. Why then do grass swales exhibit such mediocre performance in removing soluble nutrients and metals from urban stormwater? Prior swale monitoring studies in such diverse locales as Florida, Virginia, Maryland, and Washington have all shown a very limited capability to remove these soluble pollutants (removal rates of 0 to 40%) unless the majority of runoff infiltrates into underlying soils, and effectively disappears (See MWCOG, 1983).

Some answers to this vexing question can be found in the experiments of a team of researchers in the Orlando, Florida area (Yousef *et al.*, 1985). Although the Central Florida study is nearly a decade old, its results have not been widely disseminated, and can help in understanding the pollutant removal dynamics within grass swales.

The team took an experimental approach in which they selected two representative test swales. Each test swale was long, and had gentle slopes and moderate

infiltration rates (Table 1). Each test swale was then spiked with a known concentration and volume of simulated urban runoff in a series of six experiments. The experiments simulated flow events that ranged from 0 to 2.8 watershed inches of runoff through the swale. This feat was accomplished using a submersible pump to withdraw water from an existing runoff pond, and then distribute it through the test swales for a period of approximately four hours. Samples were collected at various points along the length of each swale, and the change in runoff volume and pollutant concentration were analyzed with respect to distance to determine pollutant removal rates.

### Soluble Nutrients

The results of the experiments were generally consistent with other swale studies that showed little capability to reduce the concentration of soluble forms of nitrogen and phosphorus as they passed through the swale. As can be seen in Table 2, little or no reduction in soluble nutrient concentration was observed, despite the fact that runoff took 30 to 60 minutes to traverse the several hundred feet of each swale. Yousef and his colleagues also examined the longitudinal trend in soluble nutrient concentrations through each swale, and found that concentrations slightly increased, decreased or stayed the same, and showed no discernible pattern.

The bulk of the observed pollutant removal in the swales could be accounted for by simple infiltration of runoff through the bottom of the swale. Indeed, a cursory glance at Table 3 shows that total removal rates and the fraction of total runoff infiltrated into the swale bottom were essentially identical. Low velocities that provide sufficient time for extensive infiltration appear to be essential to achieve high removal rates. When infiltration was low or modest, removal of soluble pollutants was generally quite poor. This implies that the major pollutant removal mechanism in swales is an underground one (infiltration) and not necessarily a surface one (filtering and adsorption).

The behavior of soluble phosphorus through the test swales underscores this point. The concentration of phosphorus in the swales was quite variable (Table 2), showing small increases and decreases along the length of the swale. In general, the soluble phosphorus concentrations in the swales were actually higher than

**Table 1: Characteristics of the Two Test Swales Through Experimental Swale Systems**

Swale Characteristic	Maitland	EPCOT
Length	160 feet	550 Feet
Water Table	Low	High
Infiltration Rate (in/hr)	1.4	0.5
Vegetation	short, dense bahia grass	only 20 to 80% grass cover—remainder is exposed earth
Soils	sandy, very low clay and organic matter	sandy w/ higher organic matter
Residence Time (minutes)	30 to 60	30 to 60
Slope	less than 1%	less than 1%



**Table 2: Percent Change in Nutrient Concentration Through Experimental Swale Systems**

Site No.	Nitrate-N	Ammonia	Organic N	Total N	Diss. P	Total P
M-6	2	15	5	(-2)	0	7
E-4	(-6)	(-39)	4	2	11	9
E-5	10	1	18	14	(-20)	(-48)
M-1	7	11	1	9	12	14
M-2	33	32	(-1)	25	47	48
M-3	19	80	(-134)	30	30	17

the concentrations in highway runoff coming into the swales. The authors thought that this could reflect the release of soluble phosphorus as a result of the mineralization of grass clipping and thatch within the swales. They also cautioned that the soils of the test swales were very low in clay or organic matter content, and therefore had much less potential for soil adsorption.

**Soluble Metals**

Most stormwater researchers report removal of total trace metals, but do not independently measure the fraction present in soluble form. This can be significant as soluble metals usually exert the greatest impact or toxicity to aquatic life. Many trace metals are primarily found in soluble forms (cadmium, copper and zinc), while others are mostly attached to sediment particles (iron and lead). Yousef's study indicated that while swales were quite effective in removing total metals in urban stormwater runoff, they were much less effective in removing soluble metal species (Table 4). Two different pollutant removal mechanisms appear to be working in swales. The first involves settling of particulate fractions, and the second involves adsorption of soluble metals to exchange sites in the soil. While settling occurs during every storm, adsorption requires that the

metal be present in runoff as a positively charged cation that can be adsorbed to a negatively charged particle in the soil or organic layer. Metals, however, can be found in complex number of ion species depending on the prevailing acidity (pH) of runoff. Some metals such as zinc readily adsorb to soil at pH levels typical of stormwater runoff (6.5 to 8.0), but many others (aluminum, cadmium, copper, chromium and lead) show little tendency to adsorb to soils within this range. Consequently, the ability of swale soils to remove many soluble trace metals tends to be rather low (Table 4). Yousef and his colleagues also note that metal adsorption can be reversed under certain stormwater conditions, thereby releasing metals that had been trapped in the soil back into the runoff stream.

The swale experiments, coupled with recent performance monitoring data, provide useful insights on how to design swales to maximize removal efficiency for soluble pollutants of concern. Some key design features include the use of techniques to promote greater infiltration with swales (locating on sandy soils, soil amendments to promote greater infiltration, sand trenches, and perforated underdrains), greater ponding (checkdams, off-line swales), or longer detention times (broader bottoms, greater length). The key point is that swales cannot be designed to solely rely on adsorption

**Table 3: Estimated Nutrient Removal in the Test Swales (Arranged in Ascending Order of Runoff Infiltration Achieved)**

Site No.	Infiltration Volume	Nitrate-N	Organic-N	Total N	Diss. P	Total P
M-6	26%	(-2)	22	27	26	31
E-4	38%	48	41	39	43	45
E-5	50%	(-21)	41	24	40	27
M-1	57%	57	64	61	62	63
M-2	60%	67	63	73	797	9
M-3	100%	100	100	100	100	100



R0080018

Table 4: Removal of Dissolved and Total Trace Metals in Highway Runoff Along Florida Grass Swales

Trace Metals	Percent dissolved (%)	Dissolved fraction removal (%)	Total metals removal (%)	Major removal mechanisms for dissolved fraction
Aluminum	23	20	76	very limited adsorption
Cadmium	90	18	29	some adsorption
Copper	85	19	41	very limited adsorption
Chromium	61	13	44	very limited adsorption
Iron	12	44	71	strong precipitation
Lead	10 to 50	50	91	
Nickel	75	47	88	
Zinc	64	82	90	very strong adsorption

to grass and soils as the primary pollutant removal mechanism. Other, more structural techniques, need to be included in the design to achieve more consistent removal of soluble pollutants.

—TRS

#### References

- Yousef, Y. M. Wanielista, H. Harper, D. Pearce and R. Tolbert. 1985. *Best Management Practices-Removal of Highway Contaminants by Roadside Swales*. Final Report. University of Central Florida. Florida Department of Transportation. 166 pp.
- Metropolitan Washington Council of Governments. 1983. *Urban Runoff in the Washington Metropolitan Area: Final Report*. Nationwide Urban Runoff Project. Dept. of Environmental Programs. Washington, DC. 220 pp.

## Ditches or Biological Filters? Classifying Pollutant Removal in Open Channels

Archaeologists tell us that humans started digging ditches several thousand years ago, beginning with the extensive ditch networks dug by early civilizations to irrigate the "fertile crescent" of the Middle East. Ditch digging hasn't changed that much since then, although stormwater engineers now refer to them by fancier terms such as "open channels" or "grass swales." In reality, these terms are rather broad and imprecise, and fail to distinguish the potential differences in pollutant removal potential that various channel designs can have during small storms. In this sense, open channels can be classified into one of four possible categories, based on their hydrologic design. They are the drainage channel, grass channel, dry swale and wet swale (Figure 1).

The open channel design in most common use is termed a *drainage channel*, and is designed to have enough capacity to safely convey runoff during large storm events without erosion. Typically, a drainage channel has a cross-section with hydraulic capacity to handle the peak discharge rate for the 10-year storm event, and channel dimensions (i.e., slope and bottom width) that will not exceed a critical erosive velocity during the peak discharge associated with the two-year storm event. Consequently, most drainage channels provide very limited pollutant removal, unless soils are extremely sandy or slopes are very gentle.

To achieve greater pollutant removal, stormwater engineers have recently employed *grass channels*. A grass channel is designed to meet runoff velocity targets for two very different storm conditions: a water quality design storm and the two-year design storm. During the "water quality storm," runoff velocity typically cannot exceed 1.5 fps during the peak discharge associated with the six month rainfall event, and the total length of the channel must provide at least 10 minutes residence time. In some regions of the country, grass channels are termed "biofilters" (Seattle METRO, 1992). To meet the water quality criteria, grass channels must have broader bottoms, lower slopes and denser vegetation than most drainage channels.

A third open channel is termed the *dry swale*. In a dry swale, the entire water quality volume is temporarily retained within the swale during each storm, allowing time for it to filter through 30 inches of prepared soil before it is collected by an underdrain pipe (see Figure 2). A dry swale is often the preferred open channel

option in residential settings since it is designed to prevent standing water that makes mowing difficult and generates complaints. The swale is designed to rapidly dewater, thereby allowing front yards to be more easily mowed. Design methods for the dry swale can be found in Claytor and Schueler (1995).

The last open channel design is termed a *wet swale*, and occurs when the water table is located very close to the surface. As a result, swale soils often become fully saturated, or have standing water all or part of the year once the channel has been excavated. This "wet swale" essentially acts as a very long and linear shallow wetland treatment system. Like the dry swale, the entire water quality treatment volume is stored and retained within a series of cells in the channel, formed by berms or checkdams. In some cases, the cells may be planted with emergent wetland plant species to improve removal rates.

Few stormwater treatment practices exhibit such a great variability in pollutant removal performance as open channels. In this article, 16 historical performance monitoring studies of "grass swales" were reanalyzed based on the open channel classification presented earlier to try to explain this variability. Ten of the open channels could be classified as "drainage channels" based on two criteria: they were designed only to be non-erosive for the two-year storm, and their particular combination of soil and slope did not allow significant infiltration of runoff into the soil profile. Site data and pollutant removal data are shown in Table 1(a).

The remaining six open channels were either explicitly designed as a grass channel, dry swale or wet swale, or had a combination of soils, slope and water table so that they effectively functioned as one of these three systems (Table 1(b)). Given the relatively small number of open channels that met these criteria, they were lumped together as a single group, and are hereafter termed "water quality channels."

As a group, drainage channels provided negligible removal of most pollutants. For example, only four of nine drainage channels had a positive removal rate for suspended sediment, and all but two channels had phosphorus removal rates lower than 15%. Removal rates for all forms of nitrogen were consistently low or nonexistent. The three studies that examined the ability of drainage channels to remove fecal coliform bacteria also found no significant change in the counts of this

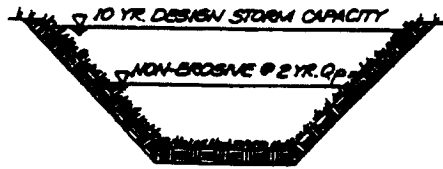

(a) DRAINAGE CHANNEL

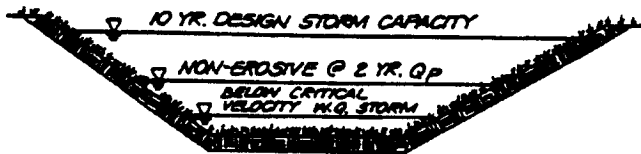

(b) GRASS CHANNEL

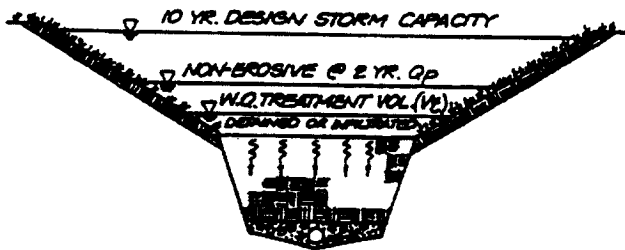

(c) DRY SWALE

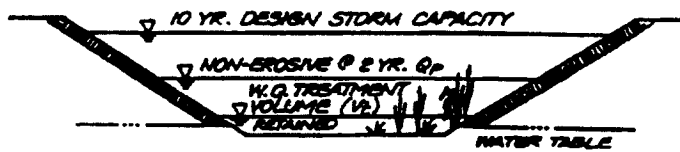

(d) WET SWALE

Open channels can be designed in one of four ways—as either (a) a drainage channel, (b) a grass channel, (c) a dry swale, (d) a wet swale. All open channels are typically designed to convey the ten year design storm, and prevent critical erosive velocities during the two year design storm. The grass channel is designed to achieve a critical velocity during a water quality design storm. The dry swale is designed to capture and treat the entire water quality volume in the swale. The same is true for the wet swale, except that the storage is provided by a pool of water, due to the presence of a high water table.

Figure 1: Open Channel Options for Treating Urban Stormwater

key indicator of human health. While some channels did exhibit a moderate ability to remove trace metals often found attached to particles (i.e., lead and zinc), an equal number showed no metal removal capability whatsoever.

In contrast, the water quality swales demonstrated a much greater and more consistent capability to remove pollutants conveyed in urban stormwater. In nearly every case, most of the mass removal could be accounted for by the infiltration of runoff into the soil profile during storms (i.e., actual pollutant concentration did not change appreciably as they passed through the channel). As a group, water quality channels showed excellent removal of suspended sediment, nitrogen, organic carbon and trace metals. The only study that examined hydrocarbon and bacteria removal indicated high removal rates for hydrocarbons, but poor removal for bacteria. Phosphorus removal for water quality channels was mixed, with two channels reporting phosphorus removal greater than 80%, but the other three reporting removal rates of 30% or less.

The clear implication is that channels that are designed to infiltrate, retain or at least achieve a modest contact time during most storm events will perform much better in removing most pollutants than a typical drainage channel. Phosphorus, however, may be the exception. Monitoring has shown that open channels have high phosphorus levels stored in the thatch and surface soil layer. Some of the stored phosphorus may recycle back into the water column, or be eroded during larger storms. Indeed, when outflow concentrations of open channels are compared to other stormwater practices, open channels appear to have a higher “irreducible concentration” of sediment, total phosphorus and soluble phosphorus than all other stormwater practices.

This reanalysis of historical performance monitoring studies clearly supports the idea that a drainage channel by itself cannot be considered an effective stormwater management practice, unless soil and slope conditions are exceptionally favorable. To be effective, open channels should be explicitly designed to increase the volume of runoff that is retained or infiltrated within the channel. Suggested design guidelines for the dry swale, which can be used in many residential settings, are detailed in Table 2. The novel aspect of these guidelines is that the channel is no longer designed based on a rate of flow, but rather a defined water quality volume (which makes swale design more consistent with other stormwater practice designs).

—TRS



Table 1: Pollutant Removal Capability of (a) Drainage Channels and (b) Water Quality Swales

No.	Ref.	State	Year	No. of Samp.	Mass or conc. method	Slope	Length	Contrib. area (acres)	Soil	TSS	OC	TP	SP	TN	NO <sub>3</sub>	Cu	Pb	Zn	Other
<b>(a) Ten drainage channels</b>																			
1	OWML	VA	1983	33	M	1.8	260	9.5	SL	Neg.	Neg.	Neg.	-	Neg.	-	-	Neg.	Neg.	-
2	OWML	MD	1983	50	M	4.1	445	19.0	SL	Neg.	Neg.	Neg.	-	Neg.	-	-	Neg.	Neg.	-
3	OWML	MD	1983	8	M	5.1	425	12.0	SL	31	Neg.	Neg.	-	37	-	-	33	Neg.	-
4	Dorman	VA	1989	9	M	4.7	185	1.3	SL	65	76	41	-	-	11	28	48	49	TKN = 17
5	Dorman	MD	1989	4	M	3.2	193	1.3	SL	Neg.	23	12	-	-	Neg.	14	55	9	TKN = 9
6	Yu	VA	1989	4	M	5A	200	1.5	-	68	-	60	-	-	-	-	-	74	-
7	Yousef	FL	1985	6	C	1.0	550	-	Sa	-	-	8	26	13	11	14	27	29	TKN (-20)
8	Oakland	NH	1983	11	C	>2%	100	-	-	33	-	Neg.	Neg.	-	-	48	57	50	Coli = NSD
9	Welborn	TX	1987	19	C	-	200	2.9	-	NSD	Neg.	Neg.	Neg.	Neg.	Neg.	NSD	NSD	NSD	Coli = NSD
10	Pitt	Ont.	1986	50	C	-	-	-	-	NSD	-	-	-	NSD	-	NSD	NSD	NSD	Coli = NSD
<b>(b) Water quality swales</b>																			
1	Dorman	FL	1989	8	M	1.0	185	0.6	Sa	98	64	18	-	-	45	65	81	81	TKN = 48
2	Harper	FL	1988	16	M	1.0	210	0.8	Sa	87	69	83	-	84	80	89	90	90	-
3	Harper	FL	1988	11	M	1.8	210	1.2	WET	81	48	17	-	40	52	56	50	69	-
4	Kercher	FL	1983	13	M	>2.0	-	14.0	Sa	99	99	99	-	99	99	-	99	99	-
5	Metro	WA	1992	6	C	4.0	200	16.0	Till	83	-	29	72	-	Neg.	46	67	73	HC = 75 COLI = Neg.
6	Wang	WA	1981	8	M	-	200	-	-	80	-	-	-	-	-	70	80	60	-

Soil (SL = silt loam, Sa = sandy); Coli = fecal coliforms; Neg. = negative removal efficiency; NSD = no statistically different conc. btw. control (usually pipe flow)  
 HC = hydrocarbon; M = mass; C = concentrate

## References

Claytor, R. and T. Schueler. 1995. *Designing Stormwater Filtering Systems*. Center for Watershed Protection. Chesapeake Bay Research Consortium and U.S. EPA. Silver Spring, MD 202 pp.

Dorman, M. J. Hartigan, J. Steg and T. Quaserbarth. 1989. *Retention/Detention and Overland Flow for Pollutant Removal From Highway Stormwater Runoff*. Vol 1. Research Report. FHWA/RD 89/202. 202 pp.

Grizzard et al. 1983. *Final Monitoring Report for Washington Metropolitan Area Nationwide Urban Runoff Project*. Chapter 7. Occoquan Watershed Monitoring Lab. Metropolitan Washington Council of Governments. 366 pp.

Harper, H. 1988. *Effects of Stormwater Management Systems on Groundwater Quality*. Final Report. Environmental Research and Design, Inc. Florida Department of Environmental Regulation. 460 pp.

Kercher, N. J. Landon and R. Massarelli. 1983. *Grassy Swales Prove Cost-Effective for Water Pollution Control*. Public Works. 16: 53-55.

Metro Seattle. 1992. *Biofiltration Swale Performance, Recommendations and Design Considerations*. Water Pollution Control Department. Seattle, WA.

Oakland, H. 1983. *An Evaluation of Stormwater Pollutant Removal Through Grassed Swale Treatment*. pp. 173-182 in Proceedings of the International Symposium of Urban Hydrology, Hydraulics and Sediment Control. H. Stirling ed. Lexington, KY.

Occoquan Watershed Monitoring Lab (OWML). 1983. *Final Report. Washington Area NURP Report*. VPI&SU. Metropolitan Washington Council of Governments. Manassas, VA 565 pp.

Pitt, R and J. McClean. 1986. *Toronto Area Watershed Management Study*. Humber River Pilot Watershed Project. Ontario Ministry of Environment.

Wang, T. D. Spyridakis, B. Mar and R. Horner. 1981. *Transport, Deposition, and Control of Heavy Metals in Highway Runoff*. FHWA-WA-RD-39-10. Dept. of Civil Engineering. University of Washington. Seattle, WA.

Welborn C. and J. Veenhuis. 1987. *Effects of Runoff Controls on the Quality and Quantity of Urban Runoff in Two Locations in Austin, TX*. USGS Water Resources Investigations Report. 87-4004. 88 pp.

Yousef, Y. M. Wanielista, H. Harper and R. Tolbert. 1985. *Best Management Practices-Removal of Highway Contaminants by Highway Swales*. Final Report. University of Central Florida. Florida DOT. Orlando, FL. 166 pp.

Yu, S, S. Barnes, and V. Gerde. 1993. *Testing of Best Management Practices for Controlling Highway Runoff*. Virginia Transportation Research Council. FHWA/VA 93-R 16. 60 pp.

Table 2: Key Design Criteria for the Dry Swale

- Dry swales are designed to retain the full water quality volume over their entire length, allowing for full filtering or infiltration through the bed of the swale, usually by temporary ponding 12 to 18 inches above the swale bottom.
- Pretreatment is required to protect the swale. For pipe inlets, 0.1 inch per contributing acre should be temporarily stored behind a checkdam. For lateral inflows, gentle slopes or a pea gravel diaphragm can be used.
- It is often necessary to modify the parent soils to improve their infiltration rate. Dry swales will have a prepared soil filter bed that is 30 inches deep and composed of 50% sand and 50% silt loam
- Swale filter beds are drained by a longitudinal perforated pipe to keep the swale dry after storm events.
- Swales are parabolic or trapezoidal shapes, with gentle side-slopes (no greater than 3:1 h:v), and bottom widths ranging from two to eight feet.
- Geotechnical tests must be performed to determine the location of the water table. If the water table is within two feet of the planned swale bottom, a dry swale is not feasible.

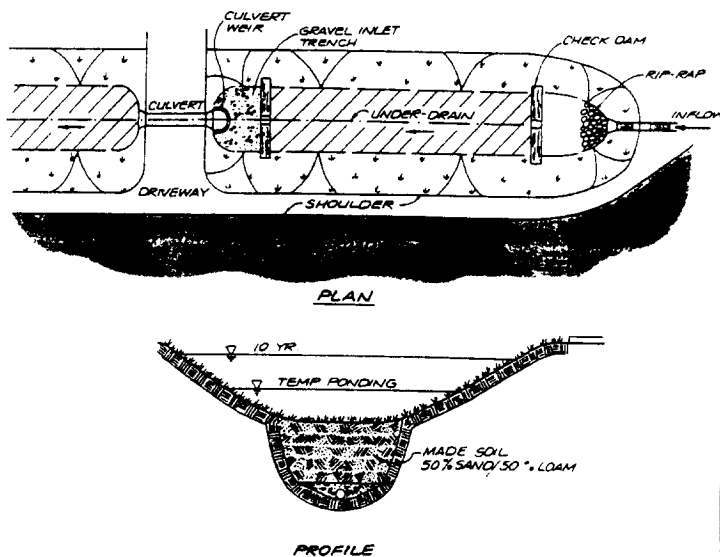

Figure 2: Schematic of the Dry Swale

## Article 117

Technical Note #96 from *Watershed Protection Techniques*, 2(4): 521-524

# Performance of Dry and Wet Biofilters Investigated in Seattle

**B**iofilters are grass channels designed to treat stormwater runoff instead of merely conveying it downstream. To remove pollutants, biofilters employ greater swale lengths, broad bottoms, gentle slopes, and dense grass turf. Together, these factors increase the residence time of runoff throughout the channel, allowing time for adsorption, uptake, settling and filtering and infiltration of stormwater pollutants. A monitoring study by Seattle METRO indicated that a 200-foot long biofilter showed promise in removing many pollutants found in urban stormwater.

Biofilters are easy to design and construct and are extremely cost-effective in comparison to other practices. For these reasons, the concept is gaining popularity in the Northwest although the practice is not yet commonplace. As more biofilters are being constructed, some nagging questions remain. First, the pollutant removal capability of biofilters is derived from a single monitoring study. If more biofilters are monitored, will they confirm the pollutant removal capability of the first study or show it to be a sampling fluke? Second, field inspections have consistently shown that most biofilters are not constructed and maintained under the ideal test conditions that were followed in the first monitoring study. Does pollutant removal performance decline in biofilters that are in fair or poor condition, and by how much?

Two recent studies from the greater Seattle area explore these questions in some detail. In the first study, Jennifer Goldberg (1993) investigated the performance of a biofilter retrofit known as the "Dayton Avenue

Swale." The original channel was a 600-foot long drainage ditch located in the right-of-way separating the backyards of a residential area. It was converted into a biofilter by reshaping the dimensions of the channel, adding top soil over the glacial till soils, and re-planting a dense cover of grass. The new dimensions of the biofilter were a length of 570 feet, a base width of five feet and an average longitudinal slope of 1%. Figure 1 shows a cross-section of the new and broader channel, with other site and design data provided in Table 1.

Goldberg sampled eight storm events at the Dayton Avenue Swale during 1991 to 1993. Sample collection was limited by "lost flows" (i.e., analysis of the biofilter revealed that as much as 30 to 80% of all incoming runoff infiltrated into the soil and never reached the downstream end). Goldberg noted that downstream runoff was seldom observed unless the biofilter soils were already saturated, and the rainstorm had at least moderate intensity and long duration. In addition, incoming sediment often dropped out in the first 50 feet of the biofilter, forming a small "hump" that impeded the flow of stormwater and caused minor ponding. In general, the investigators found it difficult to maintain a constant grade along the entire length of the biofilter. Investigators also discovered possible internal sources of pollution within the biofilter, including a colony of mountain beavers that made their burrows in the side slopes, pets that routinely used the biofilter to defecate, and adjacent trees that dropped rotting fruit into the swale.

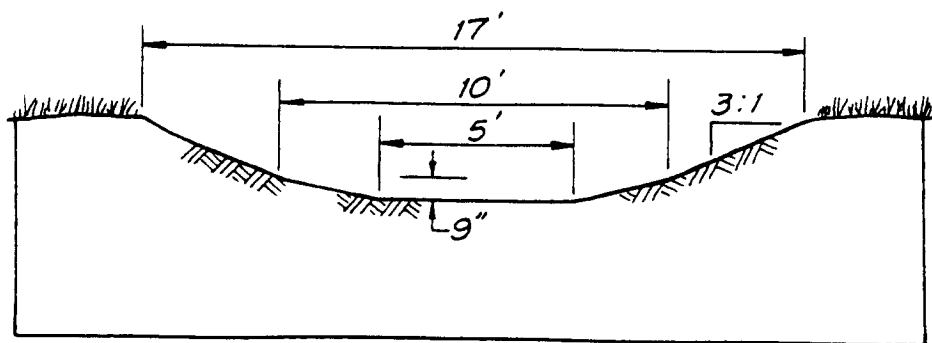

A biofilter has much broader and longer dimensions than a typical grass channel.

Figure 1: Schematic of the Cross-Section of the Dayton Avenue Swale

00

R0080024

Table 1: Comparison of Two Biofilter Performance Studies

Design characteristic	Dayton Avenue	Uplands Swale
Drainage area	90 acres, 20% Imperv.	17 acres
Length	570 feet	350 feet
Slope	1%	1.1%
Base width	5 feet	6.8 feet
Cross-section shape	Parabolic	Trapezoidal
Vegetative condition	Full grass cover	Dense wetland cover, with some subchannels formed
Design criteria for two year 24 hour storm event	Maximum Velocity: 1.5ft/sec Max Runoff Depth: 9 inches Manning's 'n' : 0.07	Conveyance only
Maintenance	Mowed several times/year, clippings removed	Never mowed, trees growing on lower side-slopes
Application	Retrofit of conveyance channel	New development
No. of Storms Sampled	8 events	17 events
Pollutant removal method	Change in upstream downstream concentration	Flow weighted change in concentration

Despite these limitations, performance monitoring revealed that the Dayton biofilter was reasonably effective (Table 2). Suspended sediment concentrations were reduced by 68%, and turbidity dropped by a smaller amount (41%). While removal of total phosphorus was negligible (5%), the biofilter was able to remove 30 to 35% of soluble or biologically-available phosphorus. In contrast to other monitored biofilters, the Dayton biofilter showed a modest capability to remove nitrate (31%). The biofilter reduced concentrations of total aluminum, copper and lead by 40 to 60%, but was only able to reduce soluble copper levels by 20%. Concentrations of oil/grease in the biofilter's outflow were always below detection limits. The biofilter, however, did a very poor job in reducing fecal coliform bacteria. Bacterial concentrations from the Dayton biofilter were about three times higher in the outflow than the inflow, which is not surprising given the potential internal bacterial sources observed (e.g. pets and beaver). Overall, the performance of the Dayton Avenue biofilter was generally comparable to that of the original Montlake Terrace biofilter site (see article 112). Removal rates for both sites may be conservative since pollutants entrained in the "lost flow" through the biofilter could not be accounted for in the pollutant removal calculations. While losing flow to infiltration makes monitoring a challenge, infiltration can be a major pollutant removal pathway for biofilters and indicates the practice is functioning properly.

#### The Upland Swale

The second study conducted in King County involved a swale that could be termed an "accidental biofilter." Although the Uplands Swale was originally designed as a conveyance channel, it was constructed to dimensions that were very similar to a biofilter. Its 350-foot long channel had a trapezoidal shape, a base width of 6.8 feet, and a longitudinal slope of 1% (see Table 1 for more site and design data). The channel had been excavated to near or below the water table, and consequently, the swale had standing water and dense wetland vegetation. Clumps of soft rush (*Juncus effusus*) dominated the wetland plant community, although some dense stands of cattail (*Typha latifolia*) were also present. Flow tended to channelize around the clumps of soft rush, but spread more uniformly as it passed through cattail stands.

Although infiltration clearly was not a factor in this wet swale, it did appear to store some runoff from minor storms (less than 0.3 inches of rainfall) and, as a consequence, runoff was seldom measured at the swale outflow during minor storms. Like many biofilters, the Uplands Swale had been neglected prior to monitoring. Poor past construction practices deposited perhaps as much as a foot of sediment on the floor of the swale. And even though the upper slopes of the biofilter were mowed about once a year, a dense growth of young alders and willows had become fully established along the lower side-slopes, and were starting to shade the channel.

The Uplands Swale was selected for monitoring for a simple reason: it was characteristic of many biofilters actually installed in the field—soggy, poorly maintained, and with wetland plants replacing grass cover. As part of the study, King County staff also inspected the field condition of 32 other biofilters. Field inspections found only 27% of biofilters in good condition with uniform grass cover and no channelization, with an additional 40% of biofilters reported to be in fair condition (some bare patches, minor channelization and soggy conditions impairing performance). The remaining 33% of biofilters were classified as “poor” and were presumed to have little, if any, pollutant removal capability (i.e., vegetation was absent and channelization was conspicuous). Major factors cited for poor biofilter condition were, in rank order, poor initial vegetative establishment, soil saturation or ponding, channelization, shading by overhanging trees and sediment deposition from construction activity.

All of these factors were present to some extent at the Uplands Swale. Because prior monitoring had involved biofilters operating under relatively ideal conditions (Dayton and Montlake Terrace), the King County study focused on biofilters in fair condition. Seventeen storm events were sampled in the Uplands Swale from 1994 to 1995. Pollutant removal was calculated on the basis of upstream and downstream changes in flow-weighted event mean concentrations (EMCs).

As might be expected, the pollutant removal performance of this wet swale was mixed (Table 3). On the positive side, the Uplands Swale reduced suspended sediment concentrations by 67%, which is comparable to the performance of a biofilter in good condition (i.e., Dayton). Reduction in total phosphorus concentrations through the wet swale was also notable (39%). On the other hand, the wet swale tended to increase the concentration of soluble and biologically active phosphorus, indicating that the swale’s soils or vegetation was releasing these phosphorus forms. The greatest release occurred during the non-growing season, whereas removal was often positive in the late spring and early summer when wetland plant growth was most vigorous. A similar phosphorus removal pattern was observed in an earlier study of a Florida wet swale.

A minor reduction in nitrate (9%) and ammonia (16%) was noted in the wet swale, which may have been due to plant uptake or microbial action. Monitoring generally indicated that metal concentrations were largely unaffected during their transit through the swale, although detection limit problems and quality control complicated the analysis. Little change was noted for total lead (6%) and total zinc (-3%), and a net release of total copper was computed. The effect of the wet swale on dissolved metals was even more equivocal, with virtually no concentration change recorded during most storm events, and more importantly, very little change with respect to aquatic toxicity thresholds.

**Table 2: Estimated Pollutant Removal of the Dayton Avenue Biofilter**

Pollutant	Removal Rate (%)	Inflow Conc. (mg/l)
Suspended Sediment	67.8	47
Turbidity	44.1	31
Total Phosphorus	4.5	0.228
Soluble Reactive Phosphorus	35.3	0.136
Bio-active Phosphorus	31.9	0.133
Nitrate-Nitrogen	31.4	1.24
Total Lead	62.1	0.037
Total Copper	41.7	0.011
Dissolved Copper	20.9	0.006
Fecal Coliform Bacteria	-264	3,725 org/100 ml
Oil/Grease	not detected	not detected (below 0.5)

**Table 3: Estimated Pollutant Removal of the Uplands “Wet Biofilter” Pollutant**

Pollutant	Removal Rate (%)	Inflow Conc. (mg/l)
Suspended Sediment	67	30.3
Total Phosphorus	39	0.13
Sol. Reactive Phosphorus	(-45)	0.04
Bio-active Phosphorus	(-31)	0.06
Nitrate-Nitrogen	9	0.345
Ammonia-Nitrogen	16	0.352
Total Copper	(-35)	0.0066
Total Lead	6	0.0023
Total Zinc	(-3)	0.025

Although the pollutant removal capabilities of the Dayton Avenue and Uplands swales were not as great as other stormwater practices, they do appear to play an important role in groundwater recharge.

#### The Biofilter Gap

When considering biofilters, watershed managers need to close the gap between the potential shown at test sites and their real world implementation. As biofilters become more popular, it appears that the gap may



R0080026

actually be widening rather than closing. When the 1995 King County field survey is compared to an earlier 1987 survey by Horner, it is evident that the field condition of biofilters has actually worsened. For example, Horner reported that 59% of biofilters that he surveyed were in "good" condition in contrast to the most recent survey, which found that only 27% could be so classified. King County's study concluded that in a typical subwatershed, the poor design, construction and maintenance of biofilters cuts downstream pollutant reduction potential by half.

Clearly, biofilter performance can only be improved if more effort is placed on construction inspection and maintenance enforcement. Given the poor experience with biofilter implementation, it seems reasonable to require performance bonds for biofilters to ensure that they are correctly installed, vegetated, and protected from construction sediment. As good practice, the performance bond would be released after a satisfactory field inspection two years after initial construction. In most cases, reinforcement plantings, sediment removal, regrading and other spot repairs would be needed before final acceptance.

Soil testing is another useful requirement to confirm soil permeability and fertility and the distance to the water table. Such data should be submitted prior to actual design to determine whether the biofilter will ultimately be dry or wet, and consequently, what specific construction methods and vegetative stabilization techniques are needed. Lastly, maintenance agreements should clearly assign the right of inspection and corrective maintenance to local governments, so that they have an enforcement mechanism to compel routine maintenance.

Basic biofilter design criteria are continually evolving. Based on recent monitoring studies and field experience, several additional design refinements seem appropriate:

- Limit biofilter length to no more than 200 feet for individual units (although designers need to consider local conditions such as rainfall and various intended uses of the biofilter).
- Require a pool or other form of pretreatment at the upper end of a biofilter if it receives concentrated inflows (to prevent a sediment buildup at the top of the swale).
- Limit longitudinal slopes to 1% or greater, unless it is intentionally designed as a "wet" biofilter.
- Develop more specific design criteria for "wet" biofilters that govern ponding, wetland stabilization, check dams and other criteria.
- Require more stringent geo-technical testing prior to design and construction.

- Lastly, as Arnold (1997) notes, it is essential to properly train public works crews on the best techniques for maintaining the long-term performance of biofilters.

—TRS

#### References

- Arnold, G.M. 1997. *Stormwater Quality Maintenance Management: Maintenance Practices and Staff Education*. Resources Management Branch, Seattle Public Utilities. 58 pp.
- Goldberg, J. 1993. *Dayton Avenue Swale Biofiltration Study*. Seattle Engineering Department. Seattle, WA. 67 pp.
- Horner, R., et al. 1988. *Biofiltration Systems for Stormwater Runoff Water Quality Control*. Washington Dept. Of Ecology. 84 pp.
- King County. 1995. *Evaluation of Water Quality Ponds and Swales in the Issaquah/East Lake Sammamish Basins*. King County Surface Water Management and Washington Department of Ecology. Seattle, WA. 75 pp.
- Reeves, E. 1995. "Performance and Condition of Biofilters in the Pacific Northwest." Technical Note 30. *Watershed Protection Techniques* 1(3): 117-119.

# Article 118

Technical Note #2 from *Watershed Protection Techniques*, 1(1): 11-12

## Level Spreader/Filter Strip System Assessed in Virginia

The effectiveness of vegetated filter strips in urban areas is frequently defeated by concentrated runoff flows that quickly erode through the strip. To compensate for this recurring problem, Yu and his colleagues designed a concrete level spreader to direct runoff evenly across the entire surface of a vegetated buffer (Figure 1).

In a practical demonstration, runoff from a 10-acre shopping center was routed into a distribution box that

diverted approximately 0.4 watershed-inches of runoff into an earthen "V" shaped trench more than 500 feet in length.

Runoff volumes in excess of this treatment volume bypassed the system via an emergency spillway located at a higher elevation at the end of the trench. A concrete weir was installed at the lip of the downslope crest of the trench, where it served to evenly spread runoff overflows across a 150-foot grassed filter strip.

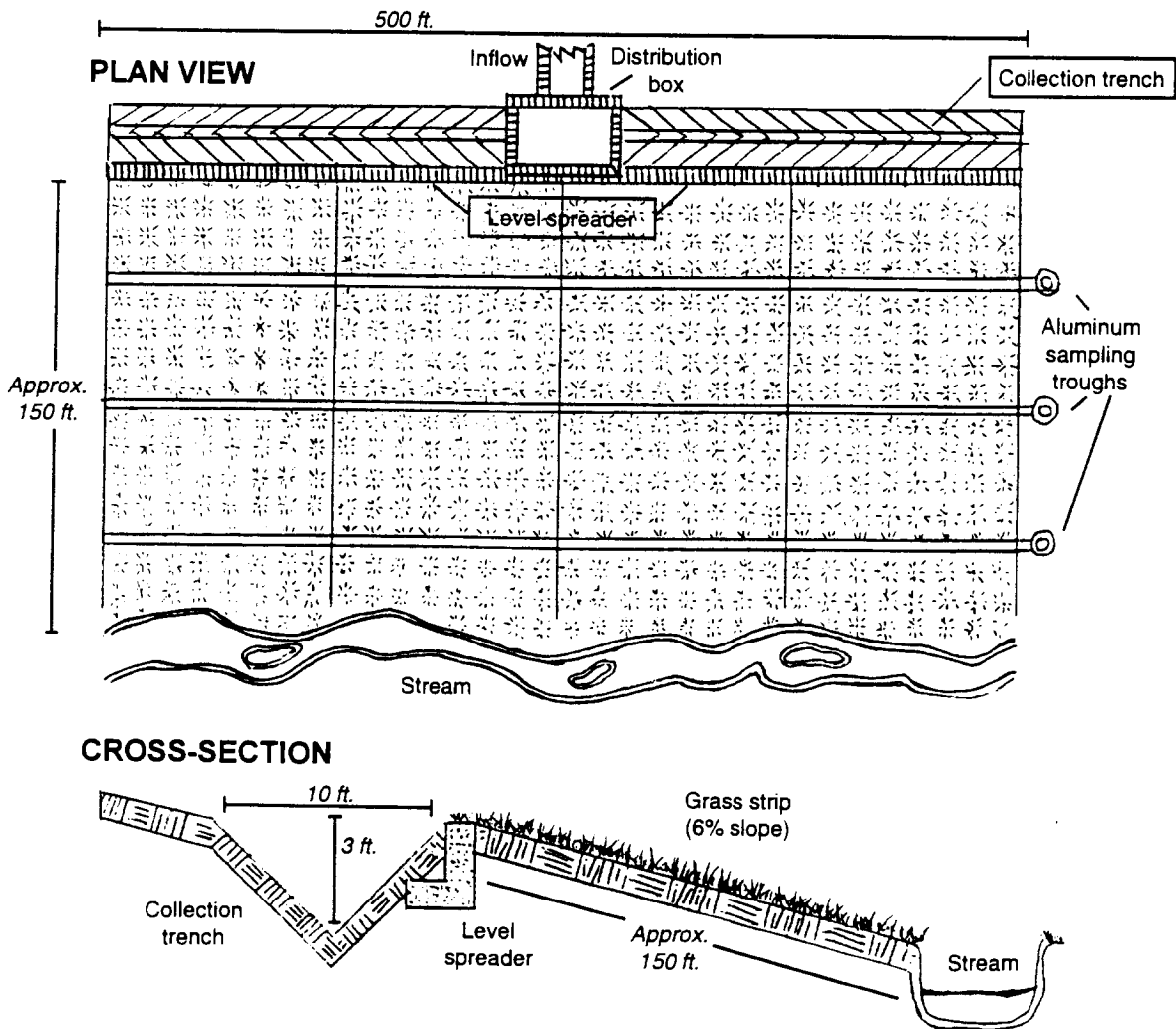

Figure 1: The Yu Concrete Level Spreader/Vegetative Buffer System (Yu et al., 1992)

The filter strip had an average slope of 6% and was primarily composed of Kentucky 31 Tall Fescue.

The pollutant removal performance was assessed through continuous monitoring at the distribution box (inlet) and grab samples collected in lateral aluminum trenches located parallel to the slope at distances of 75 and 150 feet downslope from the trench. Eight storms were monitored, of which four were deemed suitable for further analysis. The authors concluded that performance after 75 feet of filter strip treatment was mediocre, but removal of particulate pollutants increased sharply after 150 feet of treatment. Removal of nutrients such as nitrate and total phosphorus, however, was still rather modest even after 150 feet of filter strip treatment (Table 1).

The poor (and even negative) removal rates in the first 75 feet of the strip were thought to be due to sparse vegetative cover and, in some instances, gully erosion. Construction costs for the system averaged about 20¢ per cubic foot treated, which is about four times less than the cost of a comparatively-sized stormwater pond. However, the filter strip did consume a large fraction of site area (about 10% of the total site area in the project). The level spreader/filter strip system is projected to have a greater frequency and cost for maintenance than a pond system.

Regular maintenance activities include annual mowing, revegetation, and gully repair, in addition to periodic removal of deposited sediments in the collection trench. Maintenance has yet to be performed at the site in the six years since monitoring was completed.

During this time, a great deal of woody growth and weeds have replaced the dense turf cover. Despite the lack of vegetative maintenance, no obvious gully erosion was evident as of last year (Yu, 1993).

**Table 1: Measured Pollutant Removal Performance of the LS/VBS System (Yu et al., 1992)**

Pollutant	75 Foot Filter Strip (%)	150 Foot Filter Strip (%)
Total Suspended Solids	54	84
Nitrate+Nitrite	-27	20
Total Phosphorus	-25	40
Extractable Lead	-16	50
Extractable Zinc	47	55

Based on the monitoring data and simulation modeling of the filter strip, Yu and his colleagues recommended an optimal filter strip length of at least 80 to 100 feet with the level spreader.

—TRS

#### Reference

Yu, S., M. Kasnick, and M. Byrne. 1992. "A Level Spreader/Vegetative Buffer Strip System for Urban Stormwater Management." *Integrated Stormwater Management*. R. Field et al. editors). Lewis Publishers. Boca Raton, FL. pp. 93-104

Yu, S. 1993. Personal Communication.





# Performance of Oil/Grit Separators in Removing Pollutants at Small Sites

**D**espite our best hopes, some dogs just won't hunt. The same is true with the performance of some stormwater practices. A case in point is the standard oil-grit separator, or OGS (Figure 1). These underground structures consist of three chambers, two of which are wet. An inverted elbow pipe drains the second chamber, under the theory that oil and grease will initially float on the surface, but then adhere to suspended particles, which eventually settle to the bottom of the chamber. The first chamber is designed to trap grit, coarse sediments, trash and debris. The contents of both chambers should be removed on a quarterly basis as part of the normal maintenance regime.

Oil-grit separators are popular because they are relatively cheap and can be easily installed at many small sites without sacrificing land. Unlike other stormwater practices that are sized to handle a half inch or more of runoff, the total design storage volume within an OGS is about a tenth of an inch. While it has always been acknowledged that such a small treatment volume limits overall pollutant removal, it was reasoned that the basic design should at least be capable of trapping oil, grit or trash generated at parking lots. Consequently, OGS systems have enjoyed wide application at gas stations, fast food joints and other small, but highly impervious development sites. Over the last decade, several hundred OGS systems have been installed across the Washington D.C. metropolitan area, and they are still routinely included in many stormwater practice manuals in other parts of the country.

Our understanding about the pollutant removal capability of the OGS has been fundamentally changed as a result of a five-year research study by Dave Shepp and his colleagues at the Metropolitan Washington Council of Governments. In the first phase of the study, Shepp discovered four indirect lines of evidence that suggest OGS pollutant removal performance is extremely limited. First, dye tests revealed that OGS systems had very short residence times during small storms (often less than 30 minutes). Second, an average of only two inches of sediment accumulation in the two pool chambers was measured in 109 installed OGSs, and deposition did not increase no matter how long an OGS had been in service. Third, the initial finding that OGS systems did not retain sediments was confirmed by monitoring the accumulation of sediment in 17 OGSs on a monthly basis. Shepp found sediment depths frequently changed within the OGS, but seldom accumu-

lated overtime. A characteristic profile is shown in Figure 2. Lastly, none of the 109 OGS systems surveyed in the field were found to have had sediment clean-outs specified in their maintenance agreements.

In the second phase of the study, the pollutant removal performance of a typical OGS was directly measured in the field. The OGS served a one-acre parking lot of a fast food joint. Prior small site monitoring revealed that fast food parking lots generated above normal concentrations of many urban pollutants, such as hydrocarbons, nutrients, metals and carbon—giving new meaning to the term “a greasy spoon” (see Table 1). Thirteen storm samples were collected at the OGS site, using innovative sampling techniques within the confined spaces of the practice. Rainfall during the monitored storms ranged from 0.2 to 1.96 inches in depth (median 0.61 inches, mean duration three hours). Inflow and outflow event mean concentrations (EMCs) were then compared to examine pollutant removal performance for 18 different water quality parameters.

By almost any measure of performance, the oil-grit separator did not show any capability to remove pollutants in storm runoff (Table 2). Net negative removal efficiency was computed for suspended sediment, total organic carbon, hydrocarbons, total phosphorus, organic nitrogen, and extractable and soluble copper. Nega-

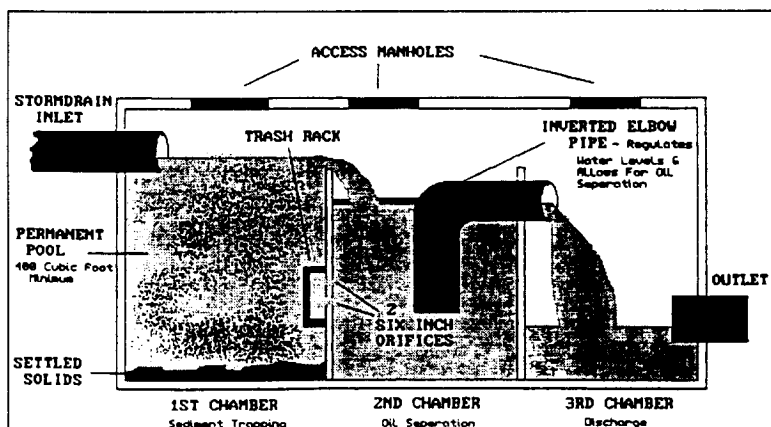

*An oil-grit separator is an underground structure used to treat stormwater runoff at very small sites. Recent research demonstrates that this practice has little or no pollutant removal capability.*

**Figure 1: Schematic of Standard Design of Oil-Grit Separator**

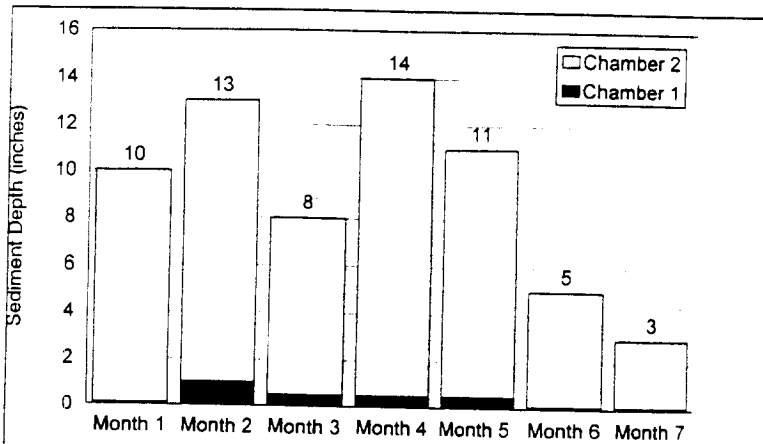

Poor sediment retention in an OGS is evident in the month-by-month fluctuation in the two main chambers.

Figure 2: Change in Sediment Depth in an Oil-Grit Separator over a Seven-Month Period (Shepp, 1995b)

Table 1: Mean of Storm Runoff EMCs for Takoma Park McDonald's Site (Shepp, 1995a; Rabanal and Grizzard, 1995)

Stormwater Pollutant	Median Concentration (mg/l)	Mean Concentration (mg/l)
Total Suspended Solids	20.8	42.9
Total Hydrocarbons	7.0	12.4
Total Organic Carbon	18.6	41.3
Total Phosphorus	0.27	0.49
Ortho phosphorus	0.06	0.101
Total Nitrogen	2.22	2.85
Total Zinc	0.144	0.452
Total Copper	0.010	0.021

Positive removal efficiencies were observed in over half the storms sampled for these parameters (with the exception of suspended sediment and soluble copper). Positive removal rates were calculated for a few parameters, most notably ortho-phosphorus, nitrate, lead and zinc, but the improvement in pollutant concentration was often very minor. This is evident when the mean outflow concentrations from the OGS are considered (last column of Table 2). The concentration of nearly every water quality parameter remains well above levels frequently encountered in "untreated" urban stormwater runoff. OGS systems also appear to have little capability to retain litter and debris, as less than 30% of the OGS systems surveyed in the project had accumulated moderate to high levels of trash and debris.

Taken together, the four different performance indicators suggest that the OGS tested was a modest exporter of several key storm water pollutants. At first glance, this finding seems physically impossible, as it is hard to imagine an internal source of pollutants within an underground concrete vault. The likely answer to this mystery involves parking lot maintenance. It seemed to be a daily practice for employees to wash down the parking lot to provide a cleaner atmosphere for customers. It is speculated the wash water may have been the source of the missing pollutants.

Based on his research, Shepp recommends that the use of standard OGS design be abandoned at small sites. Performance monitoring has shown sand filters to be a much more effective practice. He contends that no practice is likely to be effective on small sites unless it is designed to capture 0.25 to 0.5 inches of runoff at a bare minimum. Further, such practices should be designed to be off-line from the major storm water conveyance systems. Otherwise, Shepp maintains that the flows from pipes designed to carry the 10-year peak discharge rate will "hydraulically doom" any small site practice.

This contention is supported by recent performance monitoring of a modified oil-grit separator in Austin, Texas. Tom Curran sampled 17 storm events at an OGS that served a parking lot (LCRA, 1996). The modified two chamber tank contained sorbent pillows to adsorb oils, and was regularly maintained. Designed to pretreat runoff for a peat sand filter, the off-line OGS appeared to perform the pretreatment function reasonably well. Curran found that it was able to remove about 10 to 40% of stormwater pollutants that entered it (see Table 3).

Much higher removal rates were recently reported for three full-size, off-line underground structures known as multiple chamber treatment trains or MCTTs (see article 111). The design of these advanced structures stand in sharp contrast to the typical OGS. For example, the MCTT has up to 10 times more storage volume than the standard OGS design and is equipped with numerous other internal design features to promote greater removal.

In summary, the evidence overwhelmingly suggests that oil-grit separators are a very poor stormwater practice and should probably be dropped as a treatment option, unless these systems are designed off-line and with the same treatment volume of other stormwater practices.

—TRS

#### References

Lower Colorado River Authority (LCRA). 1996. *Innovative NPS Pollution Control Program for Lake Travis in Central Texas*. Lower Colorado River Authority, U.S. EPA and Texas Natural Resource Conservation Commission. (Draft Report). 52 pp.

**Table 2: Summary of Performance Data at McDonald's Oil-Grit Separator in Seat Pleasant, MD (Shepp, 1995a)**

Stormwater Pollutant	Mean Individual Storm Efficiency	Mean Group Storm Efficiency <sup>a</sup>	Majority of Storms Show Export	Mean OGS Outflow Concentration (mg/l)
Total Suspended Solids	(-21.2)	(-7.5)	NO	48.3
Total Organic Carbon	(-73.4)	(-36%)	YES	17.5
Total Hydrocarbons	(-35.4)	(-29)	YES	4.82
Total Phosphorus	(-75.5)	(-41)	YES	0.41
Ortho-phosphorus	7.6	40	NO	0.05
Total Kjeldahl Nitrogen	(-19.8)	(-44)	YES	1.74
Nitrate-Nitrogen <sup>b</sup>	34.7	47	NO	0.20
Ammonia-Nitrogen	(-44.2)	20	NO	0.11
Total Cadmium	(0)	(0)	NO	0.0011
Total Chromium	(-21.8)	(-19)	YES	0.0065
Total Copper	(-40.7)	(-11)	YES	0.013
Soluble Copper	(-58.5)	3.5	NO	0.004
Total Mercury	35.6	20	NO	0.001
Total Lead	7	8.2	NO	0.008
Total Zinc	3.3	17.0	NO	0.174
Soluble Zinc	1.6	21.1	NO	0.071

<sup>a</sup> Calculated as the mean of all inflow EMCs compared to the mean of all outflow concentrations.

<sup>b</sup> Includes nitrite.

Rabanal, F., and T. Grizzard. 1995. "Concentrations of Selected Constituents in Runoff from Impervious Surfaces From Small Catchments of Different Land Use." *Proceedings of the 4th Biennial Stormwater Research Conference*. October 18-20, 1995 Clearwater, FL. Southwest Florida Water Management District. pp. 42-50.

Shepp, D. 1995. *A Performance Assessment of an Oil-Grit Separator in Suburban Maryland*. Final Report prepared for Maryland Department of Environment. Metropolitan Washington Council of Governments. Washington, D.C. 124 pp.

Shepp, D. 1995. *Petroleum Hydrocarbons in Urban Runoff: A Study Overview*. Prepared for Maryland Dept. of Environment. Department of Environmental Programs. Metropolitan Washington Council of Governments. Washington, D.C. 160 pp.

**Table 3. Pollutant Removal Performance of an Off-Line Oil-Grit Separator in Austin, TX (LCRA, 1996)**

Pollutant	Removal Efficiency (EMC) %
Total Suspended Solids	41
Total Organic Carbon	22
Total Phosphorus	37
Ortho-phosphorus	(-14)
Total nitrogen	15
TKN	21
Nitrate	14
Lead	10
Zinc	39



# Performance of a Proprietary Stormwater Treatment Device: The Stormceptor®

The Stormceptor® is a popular proprietary storm water treatment device that has been widely applied across the U.S. and Canada in recent years. Its primary application is on small, highly impervious sites. A schematic of the device is shown in Figure 1. The device is popular because it is relatively easy to design, can be easily installed in a wide variety of applications, and can be installed in small sites without sacrificing land area. The typical device incorporates a circular holding tank that receives runoff from a flow diversion structure. Storms that exceed the capacity of the off-line device are diverted to the downstream drainage network. Unlike other stormwater practices, the Stormceptor® is designed and sized primarily on the rate of stormflow rather than its volume. Consequently, the Stormceptor® provides treatment within a much smaller area than is possible with most other stormwater practices.

A much anticipated monitoring study was recently completed by Steve Greb (Wisconsin DNR) and Robert

Waschbusch (USGS) (1998) that provides the most comprehensive and independent performance evaluation of Stormceptor to date. They installed a Stormceptor® unit as a retrofit at the Badger Road public works maintenance yard in Madison, Wisconsin in mid-1996. The maintenance yard was about 4.3 acres in area and almost completely impervious. The yard was used for refueling, maintenance and parking of heavy vehicles, and also for storage of road salt, sand, yard wastes, and other materials.

Maintenance yards often rank among the "dirtiest" pollutant source areas in the urban landscape, and the Badger Road yard was no exception. The median total suspended solid (TSS) concentration was reported to be 251 mg/l, which was slightly higher than the Wisconsin commercial street median concentrations of 232 mg/l (Bannerman *et al.*, 1996). The median chloride and total dissolved solids (TDS) runoff concentrations were 560 and 3,860 mg/l respectively, suggesting that stockpiled salt and other organic materials at the yard were a key pollutant source area.

The Stormceptor® unit selected for the retrofit at the Madison yard was the STC 6000 model with a sediment storage capacity of 610 ft<sup>3</sup>. According to Stormceptor®'s sizing guidance, this unit has a sediment storage capacity of 142 ft<sup>3</sup>/ac and is projected to have a suspended solids removal rate of approximately 75% (Stormceptor®, 1997).

Greb and his colleagues had to develop sophisticated monitoring techniques to measure the performance of such a small treatment unit. They installed flow-integrated storm samplers at the inflow and outflow locations of the Stormceptor® treatment tank, as well as at the bypass weir (see Figure 1 for locations). This sampling arrangement was needed to determine how much runoff volume bypassed the unit and was therefore not treated. If the bypass volume is high, then the treatment efficiency for the device would need to be adjusted downward. Although 24% of monitored storm events experienced some flow bypass around the Stormceptor® treatment tank, the team computed that only 10% of the total runoff volume during the study actually bypassed the device.

Flow was measured directly using a flow meter which was connected to a data-logger to initiate sampling during storm events. One composite sample was collected at the inflow and outlet for each storm event

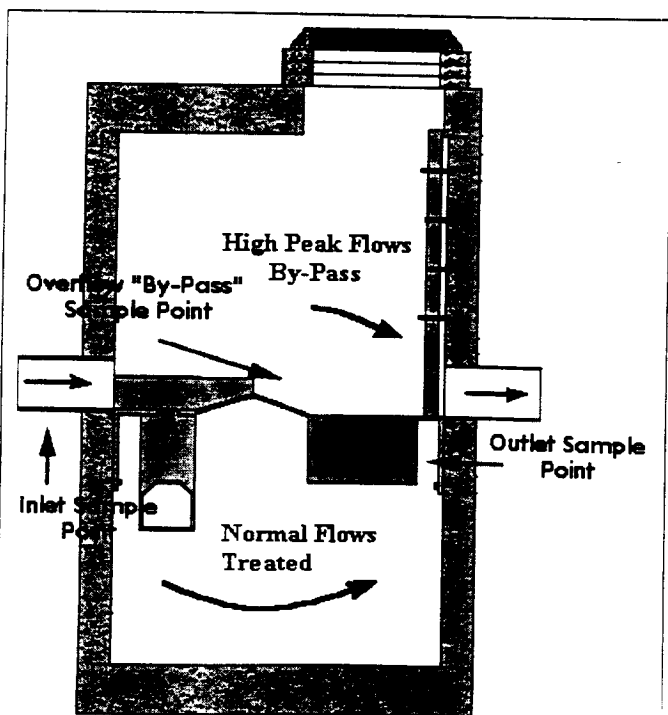

**Figure 1: Schematic of Stormceptor® Unit with Sampling Locations**

containing between five and 40 subsamples that was used to compute event-mean concentrations for the various pollutant constituents.

The sampling team evaluated the performance of the Stormceptor<sup>®</sup> during 45 precipitation events over a nine-month period that ranged in size from .02 inches to 1.31 inches. The monitoring study extended from August, 1996 to May, 1997 and included snowmelt events. During 15 storm events, the team evaluated 37 different pollutants, including a variety of solids, nutrients, metals, and polycyclic aromatic hydrocarbons (PAHs). For the remaining 30 storms, the team measured only three parameters: total suspended solids, total dissolved solids, and total phosphorus.

So how well did the Madison Stormceptor<sup>®</sup> work? Generally, the observed removal rates were lower than the manufacturer's expectations. The computed removal rates for the Madison unit are provided in Table 1. The Stormceptor<sup>®</sup> performed about as well as conventional catch basin inlets (Pitt, 1998) and certainly better than the traditional oil/grit separator. Note that the removal rates in Table 1 indicate both the actual removal efficiency of the tank, and an overall efficiency that accounts for untreated bypass flow. For example, the TSS removal rate drops from 25 to 21% when stormflow bypass is considered. The team conducted a particle size analysis and found less than 5% of the trapped sediment in the tank was of the silt or clay particle sizes. Nearly all of the trapped sediment were larger sand sized particles.

Closer examination of Table 1 indicates that Stormceptor<sup>®</sup> had a low to moderate ability to remove

particulate pollutants (e.g., solids, PAH and metals), but virtually no ability to remove soluble pollutants (with the exception of dissolved phosphorus). This is not surprising since the device relies on particulate settling for pollutant removal. Total PAHs had among the highest overall removal rate at 37%. Although oil and grease were not directly monitored, the team found that about 120 gallons of oily material had accumulated in the tank during the nine-month study. The sizeable volume of oily material was likely generated from diesel fuel from a nearby refueling station.

Another key finding of the Madison study was that Stormceptor<sup>®</sup>'s ability to remove suspended solids was dependent on the depth of rainfall in each storm event (see Figure 2). The Stormceptor<sup>®</sup> achieved fairly high rates of TSS removal (40 to 80%) when rainfall depths were less than 0.2 inches, but removal rates dropped sharply as rainfall depths increased. Winter storm events were excluded from Figure 2(a) because imported stockpiled snow at the yard contributed snowmelt that could not be related to specific measured rainfall depths.

Several factors could have affected the overall performance of the Madison Stormceptor<sup>®</sup>. First, the sampling effort included storm events during the late winter and spring of 1997. Cold temperatures and the high salinity of the water could have degraded particle settling conditions within the Stormceptor<sup>®</sup> tank during these events. Pitt (1998) found that winter settling velocities were about half of the settling velocity expected during the summer months for the same-sized particles. Further, snowmelt from stockpiled snow at the yard increased the inflow to the unit in the winter and

**Table 1: Reported Pollutant Removal Efficiencies for the Stormceptor<sup>®</sup> From Madison, Wisconsin, Dept. of Public Works Maintenance Yard (Greb *et al.*, 1998)**

Pollutant	Tank Efficiency			Overall Efficiency Including Bypass		
	Total load in	Total load out	Removal efficiency (%)	Total upstream load	Total downstream load	Overall removal efficiency (%)
TSS (kg)	1,257	943	25	1,506	1,192	21
TDS (kg)	29,743	36,022	-21	30,051	36,330	-21
TP (kg)	1.43	1.16	19	1.60	1.33	17
Dissolved P (kg)	0.39	0.31	21	0.49	0.40	17
Total Lead (kg)	0.104	0.075	28	0.120	0.096	24
Total Zinc (kg)	0.590	0.465	21	0.728	0.603	17
Total PAH (kg)	0.058	0.036	37	0.066	0.045	32
Cl (kg)	6,066	7,685	-27	6,147	8,036	-25
NO <sub>2</sub> +NO <sub>3</sub> (kg)	0.270	0.254	6	0.297	0.281	5



(a) TSS Removal Efficiency for Storms Not Influenced by Snowmelt or Snow Storage

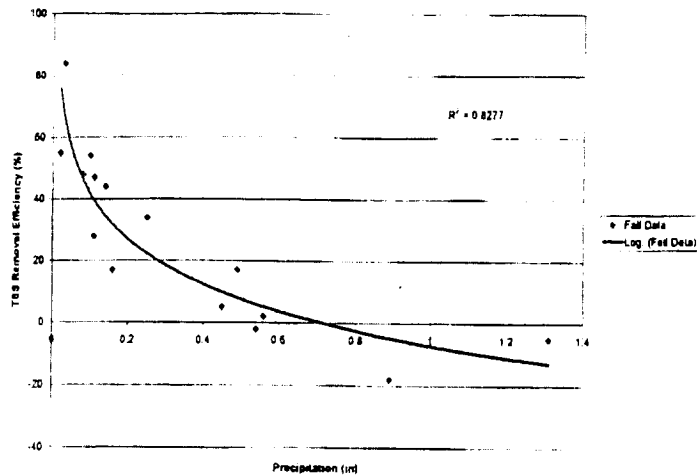

(b) TSS Removal for All Storms

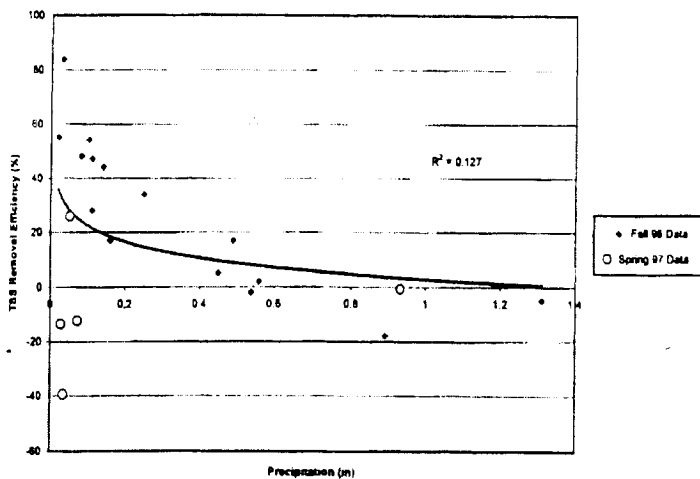

Figure 2: TSS Removal as a Function of Rainfall Depth for (a) Storms Not Influenced by Snowmelt and (b) All Storm Events

spring. By contrast, summer and fall storm events were not influenced by high chloride levels but experienced the greatest rainfall intensity and, consequently, the most storm bypasses.

Second, the sampling methods for measuring TSS could have slightly underestimated the actual removal since it did not fully measure the transport of sand. Sample intakes were located above the bottom of the inflow pipe and therefore could have failed to sample

larger sand sized particles moving along the bottom of the pipe. The sampling team was able to calculate the missing bedload by measuring the amount of sediment actually trapped in the tank at the end of the study. They estimated that the unsampled bedload was about 8% of the total sediment load, and the maximum solids removal efficiency would increase to about 29 to 33% if the bedload was included.

#### Stormceptor Field Tested in Edmonton, Alberta, Canada

A second and more limited independent evaluation of Stormceptor<sup>®</sup> was performed by the City of Edmonton, Alberta, Canada (Labatiuk, 1997). The City monitored nine storms at a 9.9 acre commercial shopping center. The monitoring protocol required that three consecutive dry days occur before the storm sampler was triggered, in an effort to test the capability of Stormceptor to remove pollutants from "first flush" storms. Table 2 illustrates the pollutant removal rates for several pollutants, based on an analysis of four storm events during the second year of monitoring. Mean TSS removal was about 50%.

During the first year of monitoring, equipment difficulties and improper installation of some plumbing severely limited the validity of the sampling results. The results for the first year included five storms with a mean TSS removal rate of 6.9% and a standard deviation of 11.1%, but these results should be viewed with some skepticism given the monitoring difficulties and the fact that the Edmonton unit may have been undersized. Given the limited number of storms and the lack of on-site rainfall data, it was not possible to determine how pollutant removal rates were related to rainfall depths at the Edmonton site.

#### Conclusions

While the Madison monitoring effort was certainly comprehensive, more questions need to be answered to fully assess Stormceptor<sup>®</sup> technology. For example, how well would the Stormceptor<sup>®</sup> work in a more typical urban installation? Clearly, the Madison maintenance yard was a stormwater hotspot, and the salt and snow storage at the yard may have influenced the performance evaluation. For example, the settling characteristics at the Madison site may have been unusual due to extremely high levels of chlorides in the runoff. Second, the Madison tank may have been too deep. A shallower tank would allow particles to reach the bottom of the settling chamber faster, possibly increasing solid removal.

Interestingly, the Edmonton unit, with a smaller storage capacity, a shallower tank, and larger drainage area, out-performed the Madison unit, at least for the limited number of events sampled. This may have been

due to the shallow depth of the Edmonton tank, or simply a reflection of the small sample size of the Edmonton study. Clearly, more monitoring data are needed, since the Stormceptor<sup>®</sup> has been tested in a few locations and a relative handful of storms events. Additional Stormceptor<sup>®</sup> performance tests are currently underway in Colorado, Texas, and the Pacific Northwest that will expand our understanding of its performance. Based on what is known now, it is not clear whether the Stormceptor<sup>®</sup> has sufficient sediment and pollutant removal capability to serve as a "stand alone" stormwater management practice in most development situations.

Another perspective on the Madison Stormceptor<sup>®</sup> can be obtained by comparing its performance to that of the multi-chamber treatment train (MCTT) developed by Robert Pitt. One of the MCTT units also served a maintenance yard in Wisconsin, and sediment removal rates from between 83 to 98% were reported. Removal of other pollutants was on the order of 65 to 95%. The MCTT retains a much larger runoff volume per unit area than the Stormceptor<sup>®</sup>, and employed advanced techniques for inlet screens, sedimentation and filtration. By way of comparison, the MCTT had about 30 times more runoff storage volume per unit drainage area than the Stormceptor<sup>®</sup> yet also costs about 20 to 30 times as much as a Stormceptor<sup>®</sup>.

This initial round of Stormceptor<sup>®</sup> monitoring indicates that it can be reasonably effective at trapping sand, oil and grease if regular tank clean out occurs. This suggests that it may be useful for pre-treatment for other stormwater practices, particularly those that can easily clog with sediment, and at ultra urban hotspot situations where space is at a premium and designers must go underground.

—RAC

#### References

- Bannerman, R., A. Legg, and S. Greb. 1996. *Quality of Wisconsin Stormwater, 1989-94*. U.S. Geological Survey. Open-File Report 96-458. Madison, WI.
- Greb, S., S. Corsi, and R. Waschbusch. 1998. *Evaluation of Stormceptor<sup>®</sup> and Multi-Chamber Treatment Train as Urban Retrofit Strategies*. Presented at Retrofit Opportunities for Water Resource Protection in Urban Environments, A National Conference. The Westin Hotel. Chicago, IL. February 10-12, 1998.
- Labatiuk, C., V. Nataly, and V. Bhardwaj. 1997. "Field Evaluation of a Pollution Abatement Device for

**Table 2: Summary of Results of 1996 Stormceptor<sup>®</sup> Monitoring at Edmonton, Alberta, Canada Westmount Shopping Center (Labatiuk et al., 1997)**

Pollutant	Removal efficiency (%) *	Standard deviation (%)
Total suspended solids	51.5	20.5
Oil and grease	43.2	24.1
Total organic carbon	31.4	5.0
Lead	51.2	17.9
Zinc	39.1	7.9
Copper	21.5	7.5

\* Mean of four storm events monitored in 1996

Stormwater Quality Improvement." *Proceedings of the 1997 CSCE-ASCE Environmental Engineering Conference*. July 22-26, Edmonton, Alberta.

Pitt, R. 1998. *Personal Communication*. Professor. Department of Civil and Environmental Engineering. University of Alabama at Birmingham. Birmingham, Alabama.

Stormceptor Canada, Inc. 1997. *Stormceptor<sup>®</sup> - Technical Manual*. Etobicoke, Ontario, Canada.

USEPA. 1983. *Results of the Nationwide Urban Runoff Program. Vol. 1. Final Report*. U.S. Environmental Protection Agency, Office of Water, Washington, D.C.



R0080037



## Article 121

Technical Note #103 from *Watershed Protection Techniques*, 3(1): 601-604

# New Developments in Street Sweeper Technology

At one time, street sweepers were thought to have great potential to remove stormwater pollutants from urban street surfaces, and were widely touted as a stormwater treatment practice in many communities. Streetsweeping gradually fell out of favor, largely as a result of performance monitoring conducted as part of the National Urban Runoff Program (NURP). These studies generally concluded that street sweepers were not very effective in reducing pollutant loads (USEPA, 1983).

The primary reason for the mediocre performance was that mechanical sweepers of that era were unable to pick up fine-grained sediment particles which carry a substantial portion of the stormwater pollutant load. In addition, the performance of sweepers is constrained by that portion of a street's stormwater pollutant load delivered from outside street pavements (e.g., pollutants that wash onto the street from adjacent areas or are directly deposited on the street by rainfall).

Street sweeping technology, however, has evolved considerably since the days of the NURP testing. Today, communities have a choice in three basic sweeping technologies to clean their urban streets:

- Traditional mechanical sweepers that utilize a broom and conveyor belt
- Vacuum-assisted sweepers
- Regenerative-air sweepers

Traditional mechanical and vacuum-assisted sweepers use brushes to disturb street particles and a fine mist to moisten the pavement for dust control. Mechanical sweepers rely on a conveyor belt to carry the collected debris to a hopper. Vacuum-assisted sweepers suck up the loosened street particles with a vacuum and send them directly to the hopper. The most recent innovation has been a vacuum-assisted dry sweeper that uses a dry broom to loosen particles at the same time that a high-powered vacuum picks up nearly all particulate matter (Figure 1). The vacuum-assisted dry sweeper, developed by Enviro Whirl Technologies, has the ability to pick up a very high percentage of even the finest sediment particles under dry pavement conditions and, unlike other sweepers, may work effectively in wet or frozen conditions (FHA, 1997). Regenerative air sweepers blast air onto the pavement surface to loosen particles and quickly vacuums them into a hopper. Sweeping can also be done in tandem—two successive passes are made over the street, the first by a mechanical machine followed by a vacuum-assisted or regenerative air machine.

The question naturally arises whether any of these technological improvements might actually translate into greater reductions of stormwater pollutants. Roger Sutherland and his colleagues have been assessing alternative sweepers in recent years in an attempt to answer this question. Roger has resorted to a modeling approach, since it is extremely difficult to design a controlled monitoring design in the field (i.e., while one can measure pollutant concentrations in runoff after sweeping, it is very hard to determine what the pollutant concentrations would have been if sweeping had never taken place).

As a surrogate, they employed a computer model, known as the Simplified Particulate Transport Model (SIMPTM), to evaluate potential sweeper performance. SIMPTM is a continuous stormwater model that simulates the accumulation and washoff of sediment and associated pollutants from urban land surfaces. Sutherland calibrated sediment accumulation and washoff rates for SIMPTM and used the model to estimate load reductions associated with street sweeping. Overall sweeper efficiency was derived in the model by multiplying a sweeping efficiency factor by the difference between the accumulated sediment and the residual sediment on the pavement after sweeping. This

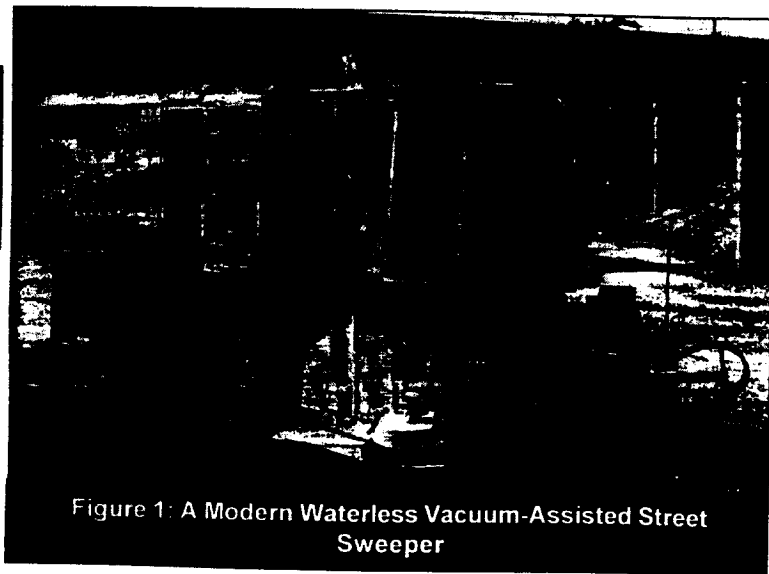

Figure 1: A Modern Waterless Vacuum-Assisted Street Sweeper

analysis is performed over a wide range of sediment particle sizes to arrive at an estimated overall efficiency. Some caution is needed in interpreting removal efficiencies derived from models, since the model may not fully incorporate all of the pollutant dynamics that occur in the real world.

Table 1 illustrates the potential sediment removal capability of five different sweepers, as estimated by the SIMPTM model (Sutherland and Jelen, 1997). Based on this analysis, it seems that the latest street sweeper technologies can pick up more street dirt and, what is more important, pick up finer-grained particles than their NURP-era predecessors (FHA, 1997). The dry vacuum-assisted and regenerative-air sweepers appeared to perform the best, although it is doubtful whether any sweeper could pick up all sediment particles from the street, as the modeling seems to imply.

While the model results suggest that sweeper improvements can pick up finer particles, debate continues as to whether this would materially improve their overall pollutant removal performance. Some of the key issues in the sweeper effectiveness debate are:

- How often do streets need to be swept?
- What kinds of streets are most appropriate for a sweeping program?
- What is the effect of "washon" of sediment and pollutants from uphill pervious surfaces?
- What percent of the annual pollutant load is associated with wetfall that sweeping misses?

### Sweeping Frequency

How often should streets be swept? The answer to this question probably depends on the region in which the streets are located. The frequency and intensity of rainfall are the key variables that control how streets need to be swept to obtain a desired removal efficiency. Sutherland has evaluated this issue in the Pacific Northwest to determine an optimum sweeping frequency (Table 2). From the standpoint of pollutant removal, the optimum sweeping frequency appears to be once every week or two. More frequent sweeping operations yield only a small increment in additional removal. The model suggests that somewhat higher removal could be obtained on residential streets, compared to more heavily traveled arterial roads.

### What About "Washon"?

Street sweeping can do little to remove sediments that "washon" to the street during a rainfall event from upgradient surfaces. The significance of sediment washon has been widely debated among stormwater professionals. Some argue that sediments are transported only during the largest storm events and should not constrain street sweeper effectiveness during most of the year. Others suggest that smaller, high intensity storms do contribute a significant percentage of the annual sediment load.

The debate over washon is very important in evaluating potential street sweeper performance. If a large amount of sediment washes onto street surfaces during a storm, it doesn't matter how clean the street surface was before the storm. Source area monitoring by Dr. Robert Pitt in two test watersheds in Toronto, Canada and Milwaukee, Wisconsin showed that significant

**Table 1: Relative Sweeper Effectiveness—Expressed in Terms of Residual Sediment Remaining After Sweeping (Lbs per Paved Acre) (Sutherland and Jelen, 1997)**

Sediment particle size (microns)	Street Sweeper Technology				
	NURP-era mechanical	Newer mechanical	Tandem sweeping	Regenerative air	Vacuum assist.-dry
< 63	9.0	5.8	2.0	0.0	0.0
< 125	12.0	5.8	2.0	0.0	0.0
< 250	18.0	5.3	2.3	0.9	0.0
< 600	18.0	2.5	2.3	1.9	0.0
< 1,000	12.0	0.4	0.8	0.7	0.0
< 2,000	4.2	0.5	0.6	0.7	0.0
< 6,370	3.6	0.3	0.5	0.0	0.0
> 6,370	1.8	0.0	0.0	0.0	0.0



amounts of runoff from pervious surfaces can occur for rains as small as a half-inch (Pitt, 1994). Clearly, this phenomenon is directly related to the amount and intensity of rainfall, the slope of the pervious surface, and the infiltration capability of the underlying soils.

While the debate continues, one important point stands out. If the entire site is paved, and there are no upgradient areas, washon load cannot occur. Consequently, when looking at street sweeper programs, the higher the impervious area, the more effective street sweeping is likely to be. Conversely, in urban areas where a large percentage of imperviousness occurs as rooftop area, the overall pollutant load removal from street sweeping will be less.

#### Wetfall Contributes to Annual Pollutant Load

One of the apparent gaps in the Pacific Northwest research is how much annual pollutant load is missed by sweepers because it was deposited as wetfall and therefore cannot be swept. For some pollutants, wetfall can account for a substantial fraction of the annual load. Table 3 compares the annual wetfall load to the total annual stormwater runoff load for some key pollutants for the Mid-Atlantic region.

Clearly, wetfall is an important delivery source for several pollutants such as total solids, total nitrogen, chemical oxygen demand, and extractable copper. Consequently, these pollutants may not be effectively controlled by a street sweeping program. It should be noted that the wetfall data presented in Table 3 is not from the Pacific Northwest, where wetfall may be less important.

#### Port of Seattle Considers Street Sweeping as an Alternative Stormwater Practice

A recent study by Kurahashi and Associates (1997) evaluated the feasibility of using a street sweeping program as an alternative to underground wet vaults to provide stormwater management for expansion of a marine cargo container yard. The Port of Seattle was planning a major expansion to its existing marine cargo container yard and wanted to evaluate whether or not new high efficiency street sweepers would be comparable to underground wet vaults in terms of removal efficiency.

Kurahashi used Sutherland's modeling technique and sediment accumulation data collected over a two-month period at nine locations within the terminal to calibrate the computer model. The calibrated model was then used to simulate the accumulation of sediment and associated pollutants on the site and the effect of street sweeping for pollutant load reduction. Wet vault pollutant removal efficiencies were estimated using a modification of Stoke's Law for the various particle sizes of the collected sediments.

Table 4 documents the results of the simulation. It was concluded that high efficiency sweeping on a weekly basis could provide comparable removal rates to wet vaults. From the viewpoint of the owner, the most significant finding of the study was the substantial cost savings street sweeping programs had over wet vaults. The anticipated life cycle cost of the sweeping programs was estimated to be about two million dollars. This can be compared to an estimated 18 million dollar price tag to construct underground wet vaults.

Table 2: Average Expected Sediment Load Reduction as a Function of Sweeping Frequency for Two High-Efficiency Sweeper Technologies\* (Sutherland and Jelen, 1997)

Sweeper Technology	Sweeping Frequency			
	Monthly	Bi-weekly	Weekly	More than once per week
<b>Residential street</b>				
• Regenerative air	42%	53%	64%	71%
• Vacuum assist.-dry	50%	63%	78%	88%
<b>Major arterial road</b>				
• Regenerative air	15%	18%	21%	22%
• Vacuum assist.-dry	50%	60%	77%	79%

\* Expected load reduction based on computer model simulation using calibrated accumulation and washoff rates in Portland, Oregon.

**Summary**

Stormwater professionals are constantly seeking new practices to reduce urban stormwater pollution. Until recently, street sweeping was perceived as an ineffective tool. Improvements in the design and operation of street sweepers may be changing this perception. The experience in the Pacific Northwest suggests that street sweeping might be reconsidered, particularly in high density urban areas where the cost of alternative underground stormwater quality treatment is extremely high.

Some concerns need to be addressed before street sweeping is fully resuscitated as a storm water practice. For example, more research is needed in other regions of the country to determine optimal sweeping frequency. Clearly, regions that have defined dry seasons would probably benefit the most from sweeping accumulated sediments before the onset of the next rainy season. Conversely, regions that have frequent high intensity thunderstorms may benefit less from sweeping since they are more likely to experience sediment washon. Additional wetfall research is needed to establish more representative pollutant removal efficiencies for street sweepers. Lastly, operational problems that diminish sweeper performance in the real world, such as speed, parked cars, and the ability to get at curb sediments, need to be explored. Roger Sutherland is currently involved in a field test of sweepers on Wisconsin highways that should shed more light on these concerns.

—RAC

**References**

FHA. 1997. *Ultra Urban Best Management Practices (Draft). Fact Sheet - Street Sweepers*. Office of Environment and Planning, Federal Highway Administration, Washington, DC. pp. 127-130.

Kurahashi & Associates, Inc. 1997. *Port of Seattle, Stormwater Treatment BMP Evaluation*. Unpublished Report. Tigard, OR. 17 pp.

MWCOG. 1983. *Urban Runoff in the Washington Metropolitan Area. Final Report. Washington DC Area Urban Runoff Project*. U.S. EPA Nationwide Urban Runoff Program. Metropolitan Washington Council of Governments, Washington, D.C.

Pitt, R. 1994. *Small Storm Hydrology*. Unpublished manuscript, from Design of Stormwater Quality Management Practices. Madison, WI, May 17-19, 1994.

Sutherland, R. C., and S. L. Jelen. 1997. "Contrary to Conventional Wisdom, Street Sweeping Can Be an Effective BMP." *Advances in Modeling the Management of Stormwater Impacts, Vol. 5*. Ed., W. James. Computational Hydraulics International. Guelph, Ontario. pp. 179-190.

USEPA. 1983. *Results of the Nationwide Urban Runoff Program. Vol. 1. Final report*. Office of Water, U.S. Environmental Protection Agency, Washington, D.C.

**Table 3: Comparison of Total Annual Wetfall Load to Total Annual Stormwater Runoff Load for Several Common Pollutants in the Mid-Atlantic Region (MWCOG, 1983)**

Pollutant	Annual wetfall load for urban/suburban areas (lbs/acre)	Annual stormwater runoff load (lbs/paved acre)	% of annual wetfall load to runoff load for paved surfaces
Total solids	50	209	24
Total nitrogen	5.3	15.5	34
Total phosphorus	0.2	2.33	8.6
COD	92.5	504	18.4
Copper	0.5	4.0	12.5
Zinc	0.75	10.8	6.9
Lead	0.04	2.2	1.8

**Table 4: Comparison of Pollutant Load Reduction of High Efficiency Street Sweepers to Wet Vaults (Kurahashi and Associates, Inc., 1997)**

Parameter	Weekly street sweeping	Wet vaults
	(% removal)	(% removal)
Total suspended solids	45-65	75-90
Total phosphorus	30-55	35-45
Total lead	35-60	65-80
Total zinc	25-50	35-45
Total copper	30-55	35-45



# The Value of More Frequent Cleanouts of Storm Drain Inlets

by Phillip Mineart & Sujatha Singh, Woodward-Clyde Consultants, Oakland, CA

**M**ost cities are drained by an elaborate network of storm drains that carry urban runoff from streets to receiving waters. Depending upon the design of the system, the storm drain system has some capacity to capture and temporarily store sediments and debris. Storage components include drop inlets, sump pits or catch basins.

While the storage capacity of each component of the system is small relative to the volume of stormwater that passes through them, drop inlets can temporarily trap some coarse sediments during smaller storms. For example, Pitt (1985) in a study in Bellevue, Washington, concluded that catch basins could trap and retain sediments up to about 60% of their total basin volume. However, large storm events often flush out the trapped sediments and convey them downstream.

Many public works departments annually remove the sediments that accumulate in storm drain inlets using vacuum trucks or manual methods. The following questions were addressed by this study: (1) If urban pollutants are present within the trapped sediments, would more frequent cleaning have any value as a stormwater treatment practice? (2) If so, would cleanouts be a feasible and cost-effective strategy compared to other stormwater practices?

To answer these questions, a consortium of local agencies in Alameda County, California began an extensive study of sediments trapped in 60 storm drain inlets.

The study examined both the volume and quality of trapped sediments within residential, commercial and industrial storm drain inlets that had been cleaned with either a monthly, quarterly, semi-annual, or annual frequency.

The drop inlet design employed in this semi-arid region of the country is 41 inches long, 25 inches wide, with depths ranging from 16 to 54 inches. These inlets were not designed to trap sediments. Site visits indicated that the material trapped in the inlets consisted of a diverse mix of trash, leaves, woody debris, decomposing organic matter and coarse sediments (Table 1). A grain size analysis indicated that over 80% of all sediments were sand (62 to 2,000 microns). About a third of all inlets were wet or had standing water. Oil sheens, methane, and obvious illegal discharges were rare (usually less than 5% of all inlets), except for industrial areas (15%).

The study found that the trapped sediments in the storm drain inlets were highly enriched with trace metals and petroleum hydrocarbons (Table 2). Residential inlets had the lowest sediment metal concentrations, but also exhibited the highest concentration of petroleum hydrocarbons. Commercial sites, which included a large mall and several vehicle maintenance operations, were generally comparable to those seen at the industrial sites, with the exception of zinc, which was higher in commercial areas.

In general, the quality of the inlet sediments was in the same range as that reported for San Francisco catch basin sediments, somewhat lower than those observed in oil-grit separator sediments, and slightly higher than the concentration found in street dust. The study also presented evidence that most hydrocarbons in inlet sediments could be traced to the products of combustion, which contain large ring structures (soot, exhaust, etc.) rather than direct spills of petroleum products themselves, which generally contain smaller ring structure.

The major objective of the study was to investigate whether an increased cleaning frequency could result in an increased removal of stormwater pollutants, and if so, determine an optimal cleaning frequency that achieved maximum pollutant removal. The study found that maximum annual sediment volume could be removed by monthly cleanouts (three to five cubic feet)

**Table 1: Summary of Storm Inlet Debris Characteristics (reported as percent of inlets with indicated characteristic)**

Characteristic	Residential inlets (%)	Commercial inlets (%)	Industrial inlets (%)
Wet	30	26	55
Trash	60	63	52
Soils	34	48	69
Leaves & wood	63	75	67
Organic material	32	28	59
Rotten egg smell	4	1	21
Illegal discharges	2	5	1
Oil/Sheen	4	1	15

**Table 2: Storm Inlet Sediment Quality (median concentrations in mg/kg)**

Land use type	Copper	Lead	Zinc	Total petroleum hydrocarbon
Residential	37.9	43.8	215	5000
Commercial	56.7	111	597.5	2050
Industrial	46.6	117	307	1950

while quarterly, semi-annual and annual cleanouts removed about the same amount of material (1.5 to 2.5 cubic feet).

For industrial inlets, monthly cleanouts removed nearly six times more sediment than annual cleanouts. A qualitative analysis of the data indicated no seasonal differences between the volume of material removed from the different storm inlets. Figure 1 shows the average mass of sediment removed per cleaning at each inlet for monthly, quarterly, semi-annual and annual cleanouts. The rising solid line indicates that the material accumulates over time. However, a substantial amount of trapped sediment flushes out prior to operation when the operation is performed only once or twice a year (Figure 1) and therefore, a much greater annual mass of sediment could be removed through monthly cleaning. The study estimated that monthly cleanouts could reduce annual copper loads to San Francisco by three to 4%, and possibly higher (11 to 12%) if the

monthly cleaning captured illegal dumping and other metal hotspots.

The study concluded that the modest pollutant removal benefit of more frequent clean outs of storm inlets needs to be balanced by the significant jump in municipal costs and staffing it would create.

**References**

Mineart, P. & S. Singh. 1994. *Storm Inlet Pilot Study*. Woodward-Clyde Consultants. Alameda County Urban Runoff Clean Water Program.  
 Pitt, R. 1985. *Bellevue Urban Runoff Project*. Final Report

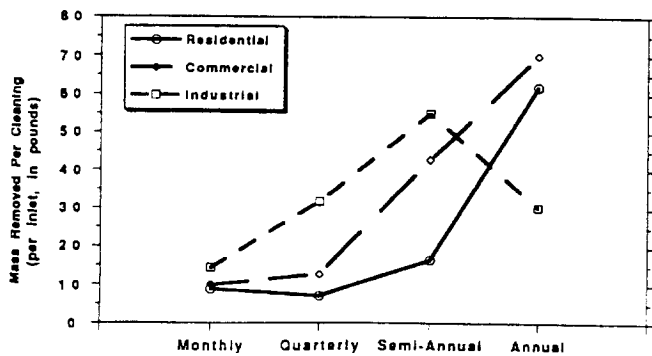

(a)

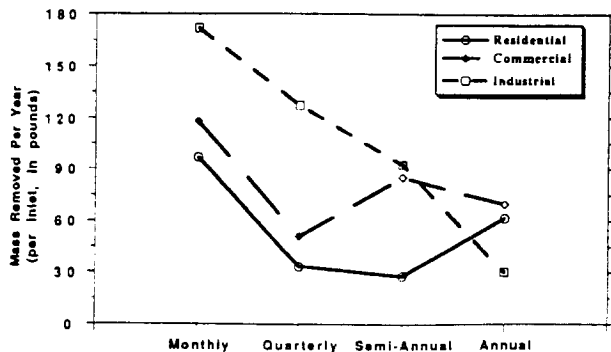

(b)

**Figure 1: Mass of Sediment Removal in Storm Drain Inlets as a Function of Cleanout Frequency (a) pounds per cleanout and (b) pounds per year**



8

R0080044

# Section 9: Watershed Protection Tool #7

## Control of Non-Stormwater Discharges

While urban stormwater dominates the hydrology of most urban watersheds, other flows can become a very important pollution source, particularly for nutrients and bacteria. These "non-storm water discharges" include septic system effluent, sanitary sewer overflows, combined sewer overflows, illicit connections to storm sewers, illegal dumping into the sewer system, industrial or municipal discharges and runoff from confined animal feedlots. Some of these wastewater discharges are present in most urban watersheds, and they can often create severe local water quality problems. This watershed protection tool concerns itself with how these non-stormwater flows are treated and where they are discharged within a watershed.

---

"A watershed manager looks to stormwater treatment to solve many different problems caused by runoff."

---

Non-stormwater discharges have not been much of a priority in the past, as managers have struggled to deal with other point and non-point sources of pollution to the watershed. Non-stormwater discharges tend to be episodic, localized and hard to detect, so the relative lack of attention given to their treatment is understandable. However, communities can no longer afford to ignore these potent sources of pollution, since federal regulations are bringing them into greater scrutiny. Three kinds of non-stormwater discharges can exist in a given watershed:

1. *Septic systems*: On-site septic systems can be a significant source of nutrients and pathogens under certain soil, terrain and maintenance conditions. Failure rates for septic systems can range from five to 30% in some regions of the country, so it is easy to see how septic systems can become a watershed problem in communities that rely heavily on them for wastewater disposal. Even working septic systems can become a significant nutrient loading source for coastal areas or lakes. Therefore, watershed managers need to carefully consider the criteria and location for new septic systems, and investigate the degree to which existing septic systems are inspected, maintained and rehabilitated. The vast number of aging and poorly maintained septic systems in many watersheds looms as a serious water quality liability in future years.

2. *Sanitary sewers*: In other watersheds, wastewater is collected in a central sewer pipe and sent to a municipal plant for treatment. Ideally, this permits more efficient collection and treatment of wastewater, but few wastewater collection systems are truly leakproof. Depending on its age and capacity, a wastewater collection system can experience periodic overflows (e.g., combined sewer overflows, and sanitary sewer overflows) or be connected to the storm drain network by mistake. Not much is known about the frequency and magnitude of these discharges, but initial research indicates that they can cause severe water quality problems in highly urban watersheds.

3. *Non-wastewater flows*: Wastewater is not the only non-stormwater discharge possible in a watershed. Watershed managers need to investigate whether other non-stormwater discharges are present in the watershed. Common examples include spills from industry or transport accidents, irrigation return flows, illegal dumping into storm drains, and runoff from confined animal feeding lots or hobby farms. While these discharges are not common in most watersheds, they can exert a strong influence on water quality in the watersheds where they do occur.



R0080045



*Trends in Non-Stormwater Discharges in the Last Decade*

As the dearth of articles in this volume suggests, non-stormwater discharges have not received much attention in the last decade, particularly when compared to stormwater runoff and wastewater treatment. Research is scant, and the scope and magnitude of non-stormwater discharges cannot be easily predicted in most watersheds. Instead, watershed managers must engage in some old-fashioned detective work to trace water quality problems back to an individual discharge point, whether it is a failed septic system, a sanitary sewer overflow or an industrial spill that enters the storm drain network. Many watershed managers tend to regard these discharges as a single, localized event, rather than a class or pattern of recurring events that deserves a comprehensive management response.

The most progress has been made with respect to septic systems, where a small but growing number of communities are tightening their requirements in order to prevent future failures or improve current performance. More stringent criteria have been adopted to govern where and when septic systems can be used in a watershed, and a handful of communities now mandate greater nutrient removal performance.

It must be admitted, however, that our skills in finding and treating non-stormwater discharges are very primitive, and it is clearly the weakest element of our watershed protection practice. Further improvement in the treatment of non-stormwater discharges will depend on three factors. First, more intensive and systematic research must be performed to trace and characterize these discharges in more watersheds around the country. Perhaps the most critical research priorities are studies to determine nutrient and microbe loadings from functioning and failing septic systems, under a broad range of soil conditions and system ages. Second, wastewater utilities must recognize that the pipes leading into their treatment plant are as important as the pipes that lead out of it, and thus more fully embrace a watershed framework. On the other hand, new utilities may need to be created in order to spread the cost of maintaining and upgrading septic systems. Third, more research and experimentation must be performed on basic methods to treat non-stormwater discharges. In particular, low-cost methods to treat both aging septic systems and aging sanitary sewer lines should be a high priority.

## **Non-Stormwater Discharges Contents**

123.	Dealing with Septic System Impacts .....	597
124.	Recirculating Sand Filters: An Alternative to Conventional Septic Systems .....	605
125.	Use of Tracers to Identify Sources of Contamination in Dry Weather Flow .....	608

**R0080046**

# Dealing With Septic System Impacts

**M**uch of the watershed development that has occurred in recent years has been in more rural areas that are not served by centralized water and sewer systems. This trend is amplified by the fact that these rural lots are often much cheaper than their counterparts in dense municipal areas. In Maryland, for example, over 80% of the land developed in the last decade was located outside the "envelope" of water and sewer lines (MOP, 1991). A consequence of this development pattern is the need for land treatment and disposal of wastewater on individual residential lots—usually by some kind of septic system. Over time, hundreds and even thousands of septic systems have been constructed in the developing rural landscape. As a result, watershed managers are faced with an enormous challenge: how to limit the cumulative impact of thousands of septic systems on the quality of surface and groundwater over many decades.

This article reviews the potential water quality impacts of both functioning and failing septic systems. In addition, it summarizes recent research and local criteria for siting septic systems to reduce failure rates, as well as innovative septic system alternatives that have greater pollutant removal capability. The importance of routine inspection and maintenance of septic systems is emphasized. Lastly, innovative local programs to improve the level of septic system maintenance are highlighted.

## What's a Septic System?

Septic systems are used to treat and discharge wastewater from toilets, wash basins, bathtubs, washing machines, and other water-consumptive items, many of which can be sources of high pollutant loads (Table 1). Septic systems are particularly common in rural or large lot settings, where centralized wastewater treatment systems are not economical. Nationally, one out of every four homes uses some form of septic system, with a combined discharge of over one trillion gallons of waste each year to subsurface and surface waters (NSFC, 1995). Because of their widespread use and high-volume discharges, septic systems have the potential to pollute groundwater, lakes and streams if located or operated improperly.

While septic systems are designed based on soil conditions, most are designed on the same principles (NVPDC, 1990). Conventional systems are comprised of a septic tank, a distribution system, and a soil absorption system (Figure 1). Variations of the basic design will be introduced later in this discussion. Wastewater is directed away from the building and into a below-ground septic tank. There, anaerobic bacteria digest organic matter, solids settle to the bottom, and low-density compounds such as oil and grease float to the water surface.

Partially-treated wastewater then leaves the septic tank and enters the distribution box, where it is discharged into the soil absorption system, also known as the drainage field. Effluent percolates through the soil

**Table 1: Daily Water Use and Pollutant Loadings by Source (USEPA, 1980)**

Water Use	Volume (liters/capita)	BOD (grams/capita)	Susp. Solids (grams/capita)	Total N (g/capita)	Total P (g/capita)
Garbage disposal	4.54	10.8	15.9	0.4	0.6
Toilet	61.3	17.2	27.6	8.6	1.2
Basins/Sinks	84.8	22.0	13.6	1.4	2.2
Misc	25.0	0	0	0	0
<b>Total</b>	<b>175.6</b>	<b>50.0</b>	<b>57.0</b>	<b>10.4</b>	<b>3.5</b>



**R0080047**

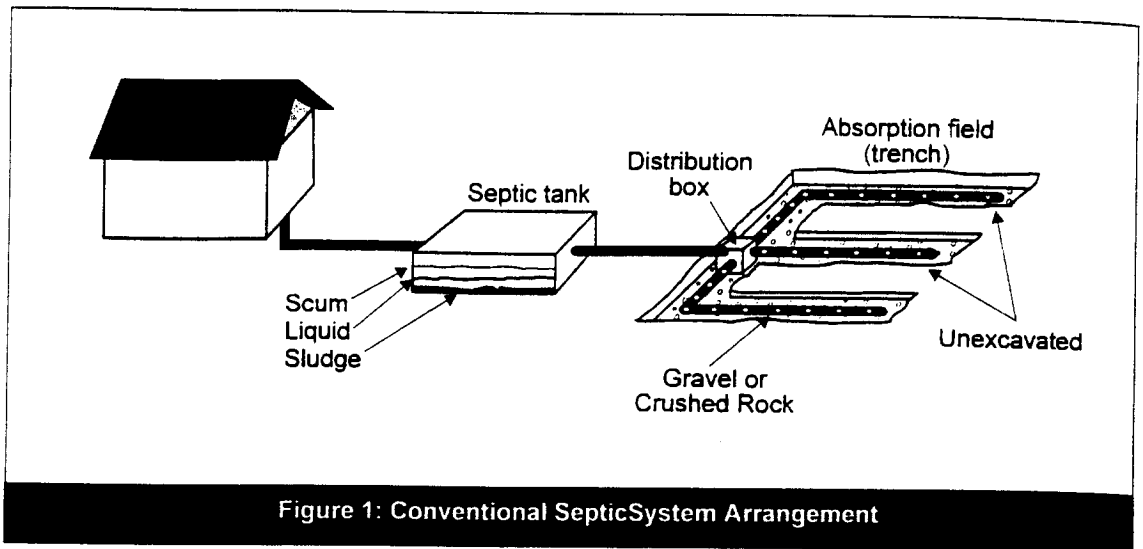

Figure 1: Conventional Septic System Arrangement

and remaining pollutants—nutrients, suspended solids, bacteria, viruses, and organic/inorganic compounds—are removed by filtration, adsorption, and microbial degradation (AGWT, 1990). The absorption system consists of a network of perforated pipes located in shallow trenches covered with backfill. Gravel usually surrounds the pipes to encourage even distribution of the effluent into the soil.

For the most part, properly sited and maintained septic systems can treat wastewater effectively and not threaten water quality. However, the effectiveness of septic systems strongly depends on site conditions and timely inspection and maintenance.

**Pollutants From Functioning and Failing Systems**

How does a septic system fail? Often, a flooded basement or lawn is the homeowner's only indicator that a septic system is not operating properly. As a rule of thumb, a failing system may be considered one that discharges effluent with pollutant concentrations exceeding established water quality standards. Proper siting is essential for efficiently operating systems. Conventional systems require relatively large land areas to allow even effluent distribution in drainage fields. In addition, there must be adequate vertical distance between the drainage field and groundwater or bedrock to ensure that effluent can adsorb to soil. Soils of sufficient grain size and texture are also necessary to both purify effluent and allow the effluent to percolate. Septic systems, and in particular drainfields, operate best when placed laterally away from natural landscape and man-made features.

Even properly functioning septic systems can deliver significant pollutant loads to groundwater (Table 2). Phosphorous and nitrogen are of particular concern in areas threatened with eutrophication. The most common shortcoming of conventional septic systems is their inability to remove significant amounts of nitro-

Table 2. Septic Tank Effluent Quality: Range of Values for Conventional Parameters - N=5 (Anderson et al. 1988)

Parameter	Value
Temperature	20.5–28.0 °C
pH	7.0–7.2
BOD <sub>5</sub>	108–163 mg/l
Total dissolved solids	330–498 mg/l
TSS	74–122 mg/l
Organic nitrogen*	16–53 mg/l
Nitrate and nitrite nitrogen*	0.01–0.17 mg/l
Total phosphorous	12–17 mg/l
Chloride	20–29 mg/l
Fats, oils, and grease	15–36 mg/l
Methylene blue active substances (measures detergent surfactants)	3.0–8.2 mg/l
Fecal coliform bacteria	6.6–7.2 log/100 ml

\* Organic nitrogen is often converted into nitrate within the drainfield

gen. Only 20% of nitrogen that passes through conventional septic systems is effectively removed, although this number may be influenced by several factors (Siegrist and Jenssen, 1989; Gold et al., 1990). It is not uncommon for the effluent leaving a typical system to have a total nitrogen concentration of 40-60 mg/L, primarily in the form of ammonia and organic

nitrogen (CBP, 1992). Once in the drainage field, organic nitrogen forms are easily converted into nitrates, which are quite soluble and easily mobilized, thus increasing the potential for ground and surface water contamination (WIDILHR, 1991).

The potential has been realized in several locations, including Buttermilk Bay, MA where it was found that 74% of the nitrogen entering the estuary was derived from septic systems (Horsley and Witten, 1994). The potential for septic systems to discharge excess pollutants is exacerbated when garbage disposal units are tied into the system (Table 3). Phosphorous loads are not great with septic systems due to its tendency to tightly adsorb to soil particles. Septic system phosphorous leaching, however, has been identified as a concern adjacent to some freshwater systems, where phosphorous is a limiting element (MIDNR, 1995).

A second group of pollutants associated with septic systems consists of pathogenic bacteria, parasites, and viruses. Improperly treated wastewater from septic systems can contain unhealthy concentrations of bacteria and viruses harmful to many organisms, including humans. In fact, the majority of groundwater-related health complaints in the U.S. are associated with septic system pathogens (NSFC, 1995). Contaminated surface waters are often closed to swimming and shellfishing due to this health risk.

Other problems with septic system performance are related to what goes into them. For example, household chemicals entering a septic tank can kill organic-consuming bacteria or cause sludge and scum to be flushed out into the drainfield. Such chemicals can include various readily available septic system additives, which ironically are advertised as having the ability to improve system performance. Not only are some household chemicals detrimental to the septic system itself, but they often reach ground or surface waters, where they exert toxic effects on organisms. Normal amounts of detergents, bleaches, drain cleaners, and toilet bowl deodorizers, however, can be used without causing harm to bacterial action in the septic tank (AGWT, 1990). Several other household wastes should be kept out of the septic system to prevent failure (Figure 2).

Pollutants that are not removed by septic systems can migrate into groundwater by leaching through the soil. Surface waters may eventually be affected as groundwater seeps into adjacent streams, lakes, rivers, and estuaries. Surface waters may also be directly impacted when systems fail and effluent ponds on or just below the soil surface. The effluent may enter ditches and open channels during storm or dry weather events. Regardless of the pathway, however, the end result can be contamination of ground and surface water resources. This problem may be magnified as the number of failing systems grows.

**Table 3: Reduction in Pollutant Loading by Elimination of Garbage Disposals (USEPA, 1993)**

Parameter	Reduction in Pollutant Loading (%)
Suspended Solids	25-40
Biochemical Oxygen Demand	20-28
Total Nitrogen	3.6
Total Phosphorous	1.7

### Preventing Failure Through Improved Siting

For proper operation, septic systems must be located in a way to ensure both lateral distance between surface waters and vertical separation to groundwater. Also, drainfield areas must become larger when soils are not permeable or slopes are steep. Daily sewage flow also influences the size of drainfields; larger volumes require large drainfields. It is always necessary to maintain separation distance from groundwater, streams, water supply wells, building foundations, impervious surfaces, and other drainfields. There appears to be no standard separation distance between septic system components and natural and man-made features. This variability may reflect regional and local differences in the ability of soil to treat effluent. States often require percolation tests although acceptable regulatory values vary considerably. In Delaware, for example, percolation rates may be six to 60 min/in, while Georgia, Michigan, and Virginia require percolation rates of 50 to 90, three to 60, and five to 120 min/in, respectively (Woodward-Clyde, 1992).

It is interesting to note that Duda and Cromartie (1982) report that drainfield density in coastal North Carolina must be less than one system per seven acres in order to protect shellfish beds from bacterial contamination. Despite the need for better siting criteria, the reality is that developing criteria for individual sites can be impractical. A comparison of septic system siting requirements throughout the United States is shown in Table 4.

### The Need for Alternatives

Unfortunately, many conventional septic systems have been constructed in areas poorly suited for their proper operation. Many were installed before the need for separation distances was understood or because no other wastewater treatment option was available. Others may have been initially installed and operated properly but have insufficient area for drainfields due to urban encroachment and high density development. Still other septic systems were installed improperly.



R0080049

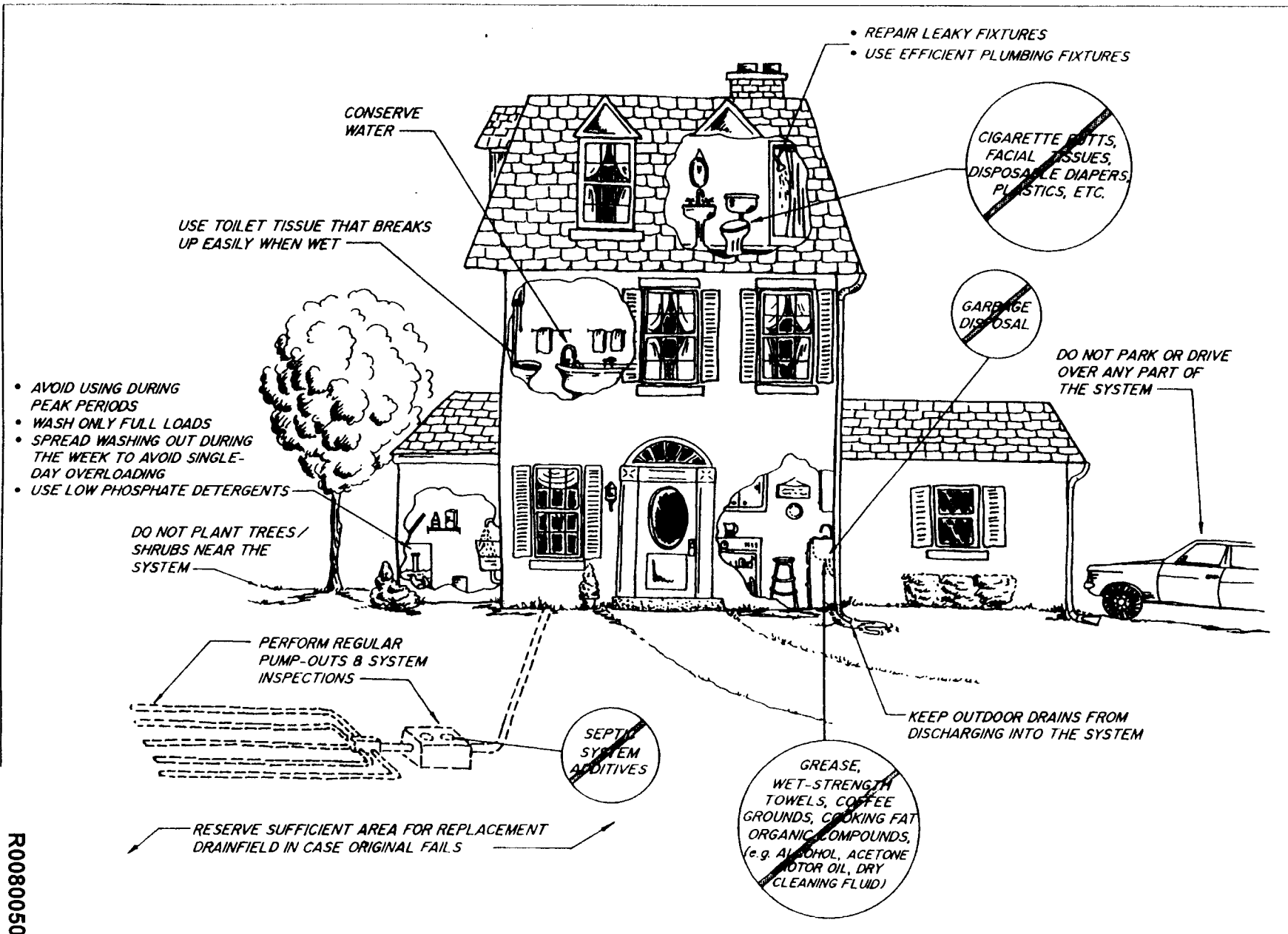

R0080050

Figure 2: Household Practices That Prevent Septic Failure

**Table 4: Example Soil Absorption System Siting Requirements and Recommendations (USEPA 1980, 1993)**

<b>Florida</b>	<p>no closer than:</p> <ul style="list-style-type: none"> <li>• 75 ft from private potable water wells and 100-200 from public wells</li> <li>• 5 ft from building foundations</li> <li>• 75 ft from mean high water line</li> </ul> <p>minimum lot size: 1/2 acre</p>
<b>Massachusetts</b>	<p>no closer than:</p> <ul style="list-style-type: none"> <li>• 10 and 20 ft from surface water supplies (septic tank and absorption field, respectively)</li> <li>• 25 and 50 ft from watercourses (septic tank and absorption field, respectively)</li> </ul> <p>systems must be at least 4 ft above groundwater</p>
<b>South Carolina</b>	<p>no state requirements; Charleston County requires minimum lot size of 12,500-30,000 ft<sup>2</sup>, depending on whether lots are served by public or private water supplies</p>
<b>Virginia</b>	<p>no closer than:</p> <ul style="list-style-type: none"> <li>• 25 ft from Resource Preservation Watercourse</li> <li>• 100 ft from Resource Management Watercourse</li> </ul> <p>if above cannot be met, no closer than:</p> <ul style="list-style-type: none"> <li>• 70 ft from shellfish waters</li> <li>• 50 ft from impounded surface waters</li> <li>• 50 ft from streams</li> </ul>
<b>Washington</b>	<p>minimum lot size:</p> <ul style="list-style-type: none"> <li>• 1 to 2 acres (dependent upon soil type)</li> </ul>
<b>U.S. EPA</b> (recommended)	<p>no closer than:</p> <ul style="list-style-type: none"> <li>• 50-100 ft from water supply wells</li> <li>• 50-100 ft from surface waters and springs</li> <li>• 10-20 ft from escarpments</li> <li>• 5-10 ft from property boundaries</li> <li>• 10-20 ft from building foundations (30 feet when located upslope from building in slowly permeable soils)</li> </ul> <p>Increased setbacks may be necessary to protect waterbodies from viral and bacteria transport to account for tidal influences and account for sea level rise.</p>

Since development continues to take place in rural areas where centralized sewer systems are impractical, it is reasonable to expect that septic systems will continue to be popular wastewater treatment options in many regions. Poor site conditions in many of these regions make conventional septic systems unsuitable. Much effort has been expended to develop alternatives to conventional septic systems. This reflects a need for other technologies that can perform well in areas where conventional systems cannot, and a desire to improve the removal of nitrogen from wastewater effluent.

Many alternatives follow the basic conventional septic system design, with certain modifications to conform with site conditions (some examples are found in Figure 3). Several designs are very attractive because of their decreased reliance on site conditions and their ability to remove pollutants that cannot be removed by conventional systems. A more detailed discussion of one of these alternatives, recirculating sand filters, is provided in article 124. Careful selection of septic system alternatives can provide significant water quality rewards (see Table 5).



**R0080051**

**Septic System Maintenance**

While alternative systems have some benefits over conventional septic systems, it is important to recognize that no system can simply be installed and forgotten. Regular inspection and maintenance is a necessity. For example, septic tanks should be periodically pumped out, since solids and sludge tend to accumulate over time (Table 6). Unfortunately, regular pumpouts of conventional septic systems is the exception rather than rule. State and local governments often refrain from aggressive enforcement of privately owned septic system maintenance requirements. As a result of the overall

lack of enforcement many systems can be failing for several years before a severely flooded basement or lawn prompts action on the part of the homeowner.

Several other effective and low-cost steps can be taken to better insure proper system operation, in combination with regular inspection, maintenance and pumpout (Figure 2). Interestingly, a major source of system failure can be mitigated simply by reducing the amount of wastewater discharged into the system. Overloading a system causes the system to back up or forces wastes through the tank before they can be adequately treated (AGWT, 1990). In addition, hydrau-

**Figure 3: Selected Alternatives to Conventional Septic Systems**

*Conventional system with alternating absorption fields*

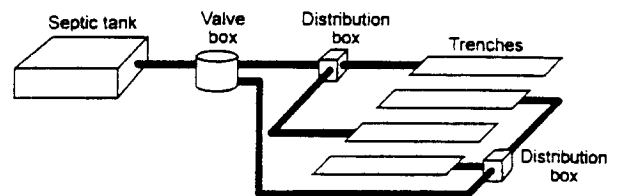

*Conventional system with serial distribution on sloping field*

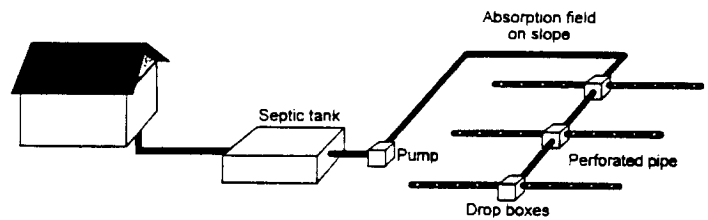

*Mound system*

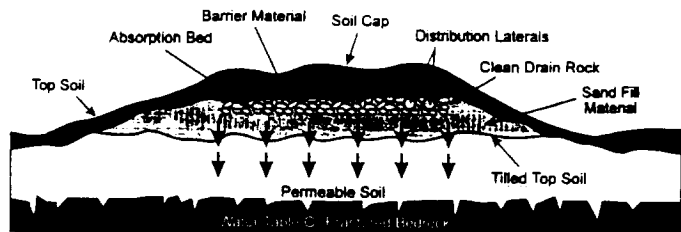

*Constructed wetland*

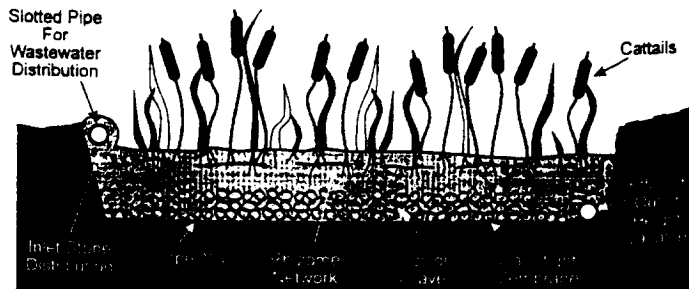

**Table 5: Conventional and Selected Alternative Septic System Effectiveness and Cost Summary (USEPA, 1993)**

Onsite wastewater disposal practice	Average Effectiveness (total system reductions)					Cost*	
	TSS (%)	BOD (%)	TN (%)	TP (%)	Pathogens (Logs)	Capital (\$/House)	Maint. (\$/Year)
Conventional Septic System	72	45	28	57	3.5	4,500	70
Mound System	NA	NA	44	NA	NA	8,300	180
Anaerobic Upflow Filter	44	62	59	NA	NA	5,550	NA
Intermittent Sand Filter	92	92	55	80	3.2	5,400	275
Recirculating Sand Filter	90	92	64	80	2.9	3,900	145
Water Separation System	60	42	83	30	3.0	8,000	300
Constructed Wetlands	80	81	90	NA	4.0	710	25

\* shown in 1988 equivalent dollars; an average household with four occupants was assumed

**Table 6. Suggested Septic Tank Pumping Frequency in Years (Mancl and Magette, 1991)**

Tank Size (gal)	Household Size (number of people)									
	1	2	3	4	5	6	7	8	9	10
500	5.8	2.6	1.5	1.0	0.7	0.4	0.3	0.2	0.1	—
750	9.1	4.2	2.6	1.8	1.3	1.0	0.7	0.6	0.4	0.3
1,000	12.4	5.9	3.7	2.6	2.0	1.5	1.2	1.0	0.8	0.7
1,250	15.6	7.5	4.8	3.4	2.6	2.0	1.7	1.4	1.2	1.0
1,500	18.9	9.1	5.9	4.2	3.3	2.6	2.1	1.8	1.5	1.3
1,750	22.1	10.7	6.9	5.0	3.9	3.1	2.6	2.2	1.9	1.6
2,000	25.4	12.4	8.0	5.9	4.5	3.7	3.1	2.6	2.2	2.0
2,250	28.6	14.0	9.1	6.7	5.2	4.2	3.5	3.0	2.6	2.3

lic overloading creates anaerobic conditions in the drainage field, reducing treatment efficiency.

The difficulty with septic system maintenance is the reluctance of many regulatory agencies to mandate, enforce or finance rehabilitation. As a result, septic system maintenance is the responsibility of the homeowner, suggesting the need for greater public education efforts to this group.

How can communities improve the maintenance of existing septic systems and rehabilitate failed ones? Rehabilitation of septic systems can be a very effective nonpoint source control strategy. Many communities have adopted this strategy to protect or restore shellfish beds and swimming beaches, or to limit nutrient loads to sensitive waters. As always, most communities have found that financing is the crucial element for success. Some innovative local septic management programs are highlighted in Table 7. Several jurisdic-

tions charge homeowners a monthly fee that is used for inspection, maintenance and education. Others have developed a revolving loan program to provide low cost loans to repair failed systems. Yet others have devised more stringent siting and technology criteria for new systems, and certify each new system only after a post-construction inspection. Ultimately, local wastewater authorities need to allocate a greater portion of their budget to systematically improve local septic system management.

-RO

**References**

American Ground Water Trust (AGWT). 1990. *Everything You Wanted to Know About Septic Tanks*. Dublin, OH.



**R0080053**



Table 7: Examples of Septic System Management Programs (USEPA, 1993; CWP, 1995)

**Georgetown Divide Public Utilities (CA)**

- Approximately 10% of agency's resources are allocated to septic system management
- Provides comprehensive site evaluation program, designs septic system for each lot, lays out system for contractor, and makes numerous inspections during construction
- Conducts scheduled post-construction inspections
- Homeowners pay \$12.50 per month for services

**Stinson Beach County Water District (CA)**

- Monitors septic system operation to identify failures
- Detects contamination of groundwater, streams, and sensitive aquatic systems from septic systems
- Homeowners pay \$12.90 per month, plus cost of construction or repair

**City of Bellevue (WA)**

- Conducts biannual septic system inspections at no charge, unless remedial actions are necessary

**Puget Sound Water Quality Authority (WA)**

- Member jurisdictions have established revolving loan funds to provide low interest loans for repair of failing septic systems

Anderson, D.L. *et al.* 1988. "Groundwater Modeling with Uncertainty Analysis to Assess the Contamination Potential from On-Site Sewage Disposal Systems in Florida." *On-Site Sewage Treatment*. Proc. 5th Nat. Symp. Individual and Small Community Sewage Treatment. Am. Soc. Agric. Eng., St. Joseph, MO.

Center for Watershed Protection. 1995. *Blueprint to Protect Coastal Water Quality: A Guide to Successful Growth Management in the Coastal Region of North Carolina*. Draft.

Chesapeake Bay Program (CBP). 1992. *The On-Site Septic System Workshop Findings and Recommendations*. Convened by the Nonpoint Source Subcommittee.

Duda, A.M. and K.D. Cromartie. 1982. *Coastal Pollution From Septic Tank Drainfields*. Journal of the Environmental Engineering Division of the American Society of Civil Engineers. 108(EE6).

Gold, A.J., W. R. DeRagon, W.M. Sullivan, and J.L. Lemunyon. 1990. "Nitrate-Nitrogen Losses to Groundwater From Rural and Suburban Land Uses." *Journal of Soil and Water Conser.* 45(2): 305-310.

Horsley and Witten. 1994. *Coastal Protection Program Workshops in Innovative Management Techniques for Estuaries, Wetlands, and Near Coastal Waters*. Sponsored by U.S. EPA, Ofc. of Wetlands, Oceans, and Watersheds.

Mancl, K. and W.L. Magette. 1991. *Maintaining Your Septic Tank*. Univ. of Maryland Cooperative Extension Service. Water Resources Publication 28.

Maryland Office of Planning. 1991. *Maryland's Land: 1973-1990, A Changing Resource*. Baltimore, MD.

Michigan Dept. of Natural Resources (MIDNR). 1995. *Michigan Coastal Nonpoint Source Program*. Draft. Land and Water Management Division, Surface Water Quality Division.

National Small Flows Clearinghouse (NSFC). 1995. *Pipeline* 6(3).

Northern Virginia Planning District Commission (NVPDC). 1990. *Your Septic System: A Guide for Homeowners*. Brochure.

Siegrist, R.L. and P.D. Jossen. 1989. "Nitrogen Removal During Wastewater Infiltration as Affected by Design and Environmental Factors." R.W. Seabloom and D. Lenning (eds). *Proc. 6th Northwest On-site Wastewater Treatment Short Course*, pp. 304-318. Seattle, WA, 18-19 September 1989. ASAE, St. Joseph, MI.

USEPA. 1980. *Design Manual—Onsite Wastewater Treatment and Disposal Systems*. Office of Water, Washington, DC.

USEPA. 1993. *Guidance Specifying Management Measures for Sources of Nonpoint Pollution in Coastal Waters*. Office of Water, Washington, DC. 840-B-92-002.

Wisconsin Dept. of Industry, Labor, and Human Relations (WIDILHR). 1991. *Onsite Nitrogen Removal Systems Research/Demonstration Project, Phase I Report: Nitrogen Removal From Domestic Wastewater in Unsewered Areas*. Madison, WI.

Woodward-Clyde. 1992. *Urban Management Practices, Cost and Effectiveness Summary Data for 6217(g) Guidance: Onsite Sanitary Disposal Systems*. Prepared for U.S. EPA, Washington, DC.

## Article 124

Technical Note #60 from *Watershed Protection Techniques*, 2(1): 288-290

# Recirculating Sand Filters: An Alternative to Conventional Septic Systems

by Rich Piluk and Ed Peters, Sanitary Engineering, Anne Arundel County (MD) Health Department

Many water quality problems have been associated with residential septic systems, mostly as the result of poor siting or maintenance. However, even systems operating according to design may discharge excessive pollutant loads that can impact nearby waterbodies (see article 123). In coastal areas, this is often particularly true with nitrogen. As a result, efforts to develop systems which show the potential for improved nitrogen removal potential have been intensified. One residential system which shows promise is the small recirculating sand filter, used primarily in Anne Arundel County for the repair of failing conventional systems (Figure 1).

When used alone, sand filters nitrify septic tank effluent, increasing ground and surface water mobilization. This problem can be resolved if the nitrates are sent through an anaerobic environment rich in organic matter. Under such circumstances, denitrifying bacteria reduce nitrates to nitrogen gas, effectively reducing threats to water quality. Recirculating sand filters, which allow nitrified sand filter effluent to mix with organic-rich septic tank effluent, provide this needed denitrification service.

Traditional waterfront development has often occurred on small lots with high water tables that are now considered unsuitable for conventional septic systems and therefore conducive to their failure. Recirculating sand filter systems can be extremely useful in mitigating this problem; in addition to having denitrifying ability, the systems can be easily placed in areas with slowly permeable soils, inadequate unsaturated soil buffer zones, and/or insufficient room for a conventionally-sized soil absorption area. Some homeowners choose to

plant trees and shrubs around the exposed structure or use the wood top as a deck.

Typically, wastewater first enters a 1,500-gallon two-compartment septic tank and then flows to a 500-gallon pump chamber. With a two-compartment septic tank, the second compartment can be used as a denitrification chamber for the mixing of septic and sand filter effluents. It is also possible to use the first compartment of a two-compartment septic tank or a single compartment septic tank for denitrification. Limited observations of these systems have shown results similar to the two-compartment design. Mixing and denitrification could also be accomplished in the pump chamber if it is of sufficient size.

It is recommended that a pump chamber of at least 500 gallons be used to permit the use of a timer. Holding capacity in the pump chamber makes it possible to store wastewater surges and dose the sand filter in brief intervals throughout the entire day. A low-level float ensures that the pump does not run dry and a high-water level alarm is used to signal the homeowner that either an abnormally high volume of water is being pumped or there is a pump problem.

The pump then sends treated effluent to the sand filter (Figure 2a). The filter is built for free access and has only 45 ft<sup>2</sup> of surface area when used to treat the wastewater from a single family home. A 2,000-gallon center seamed concrete septic tank was selected as the sand filter container because it was readily available and could be placed completely out of the ground when necessary.

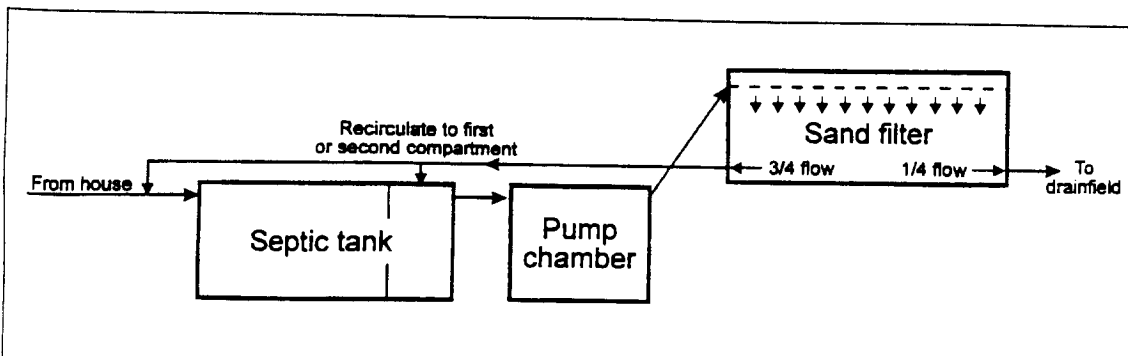

Figure 1: Schematic of a Recirculating Sand Filter

R0080055

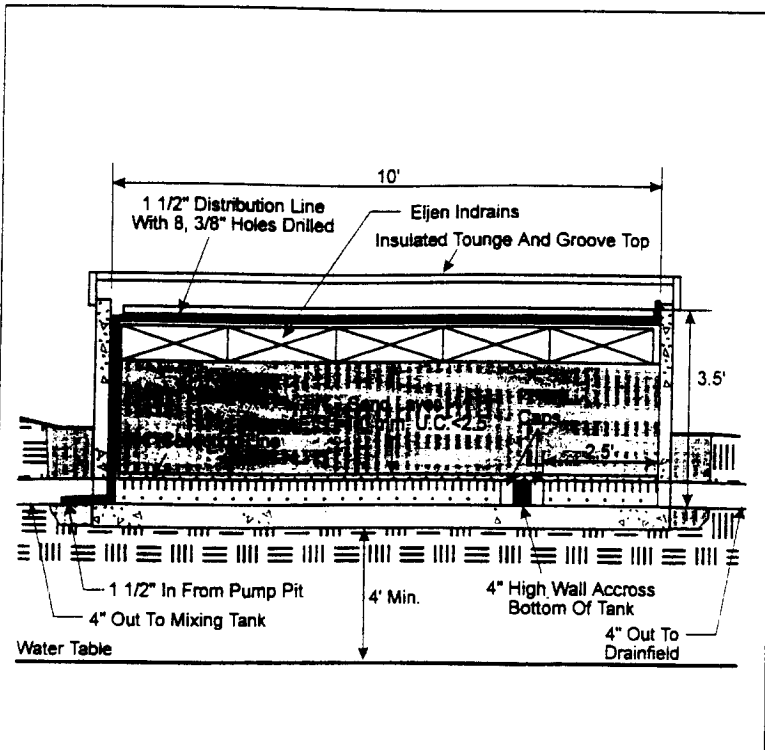

Figure 2a: Sand Filter—Length Cross-Section

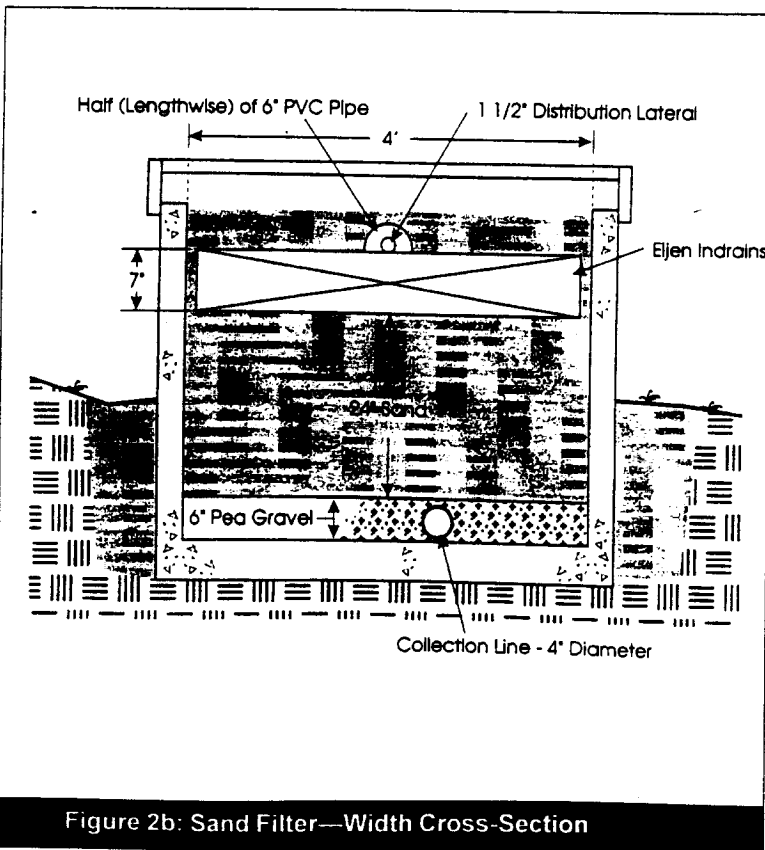

Figure 2b: Sand Filter—Width Cross-Section

Wastewater is pumped into the sand filter through a small diameter PVC lateral pipe that rests on a light-weight wastewater distribution network, such as Eljen indrains (Figure 2b). Relatively large holes are regularly spaced along the top of the lateral, which is covered by a pipe that is cut in half lengthwise. Wastewater is pumped up through the holes in the lateral, hits the underside of the pipe half, and is distributed evenly over the length of the sand filter.

A four-inch high brick and mortar wall extends across the interior width of the tank, dividing the bottom so that approximately 75% of the area is on one side of the wall. The purpose of the wall is to divide the flow after it has percolated through the sand filter. If the flow is applied evenly over the length of the sand filter, 75% of the effluent can recirculate back to mix with anaerobic wastewater, creating conditions for denitrification.

Effluent treatment in the sand filter depends upon microorganisms; as a result, the process can be adversely affected by cold temperatures. The system has performed well during a month with an average daily temperature of  $-2^{\circ}\text{C}$ . For areas that experience colder monthly temperatures, additional precautions could be taken, such as using better insulating materials at the top of the filter, adding insulation to the internal sides of the filter, placing earth around the sides, or, if site conditions allow, placing the filter deeper in the ground.

More than 150 recirculating sand filters have been installed in Anne Arundel County. Performance data have given promising results, showing pollutant removal efficiencies greater than those observed with conventional systems (Table 1). The performance of these systems is especially encouraging since they can operate for several years without maintenance and cost about the same as conventional systems. Experience with recirculating sand filters has revealed several instructive findings, several of which are listed in Table 2.

It is significant to note that the utilization of advanced septic systems is possible in Anne Arundel County because proposed system sites are thoroughly evaluated and homeowners are given incentives, such as building permit exceptions, for replacing existing systems with recirculating sand filters. If systems were routinely approved without concern for the protection of ground and surface waters, there would be no incentive to advance the design of septic system alternatives. Due to the difficulty of extending sewers in the county, there will be a growing need for septic systems that reduce nitrogen loadings to the environment, require less room to install, and are readily maintainable. Small, free-access, recirculating sand filters suggest a way to address those needs.

However, practitioners should beware of placing all reliance on one type of septic system. As always, site

**Table 1: Performance of Three Recirculating Sand Filters in Anne Arundel County, MD**

	Pollutant*	System A** (7 residents 340 gal/day)	System B† (2 residents 100 gal/day)	System A†† (2 residents 100 gal/day)	Average
Septic Tank	BOD	215	124	366	235
	Susp. Solids	72	56	97	75
	Total Nitrogen	54	45	71	57
	Fecal Coliform	3.9x10 <sup>6</sup>	1.7x10 <sup>5</sup>	1.0x10 <sup>7</sup>	1.8x10 <sup>6</sup>
Sand Filter	BOD	4	2	8	5
	Susp. Solids	8	5	10	8
	Total Nitrogen	22	17	21	20
	Fecal Coliform	3.4x10 <sup>4</sup>	240	9.5x10 <sup>4</sup>	9.2x10 <sup>3</sup>
Percent Reduction from Septic Tank	BOD	98	98	98	98
	Susp. Solids	89	90	90	90
	Total Nitrogen	59	62	70	64
	Fecal Coliform	99.1	99.86	99.0	99.3

\* Fecal coliform is presented as geometric average in organism per 100 ml. All other units are mg/L.  
 † Average of 28 sampling dates from August 1992 to March 1994.  
 †† Average of 22 sampling dates from July 1990 to October 1993.  
 ††† Average of 39 sampling dates from June 1987 to June 1993.

conditions must take priority when it comes to system selection. Care should also be taken to ensure that the use of recirculating sand filters does not override quality growth management planning.

**References**

Piluk, R.J. and E.C. Peters. 1994. *Small Recirculating Sand Filters for Individual Homes*. Anne Arundel County (MD) Health Dept.

**Table 2: Findings Related to Recirculating Sand Filter Systems**

- It is critical to use water-tight septic and pump tanks
- No special media are generally necessary in denitrification areas
- Filter cloths embedded at different depths in a sand filter tend to clog
- Having pumps on timers can warn homeowners of plumbing problems (e.g., leaking toilets) and identify groundwater infiltration problems
- Wastewater rising above the top seam in concrete septic and pump tanks can leak out without causing a clearly observed backup or overflow
- The use of advanced pretreatment can allow the use of smaller final absorption areas



# Use of Tracers to Identify Sources of Contamination in Dry Weather Flow

by Melinda Lalor and Robert Pitt, Dept. of Civil and Environmental Engineering,  
University of Alabama at Birmingham

**F**or watershed managers, the location of potential sources of bacterial contamination is an important step in addressing urban water quality concerns. Inappropriate or illicit discharges may account for a significant amount of the pollutants discharged from storm sewerage systems (Pitt and McLean, 1986), including wastewater that can be an important source of fecal coliforms and pathogens. The development of screening techniques to detect these discharges is a valuable tool in the management of urban watersheds and in achieving water quality goals in receiving waters.

Urban stormwater runoff is often made up of not just the traditional precipitation that drains from city surfaces, but also waters from many other sources, including illicit and/or inappropriate flows into the storm drainage system. The EPA's Nationwide Urban Runoff Program (NURP) recognized the significance of the impacts of pollutants from inappropriate entries into urban storm sewerage (USEPA, 1983). The final NURP report concluded that the costs and complications involved with locating and eliminating such connections might pose a substantial problem in urban areas, but provides opportunities for dramatic improvement in the quality of urban stormwater discharges.

The following article contains a description of the procedures developed during research conducted on locating inappropriate discharges, especially the factors in selecting tracer indicators and identifying source waters. These methods can be used in any urban watershed, although the selection of specific tracers would vary depending on the likely source flows. An important premise for the development of this methodology was that the initial field screening effort would require minimal effort and expense, but would have little chance of missing a seriously contaminated outfall. This screening program would then be followed by a more in-depth investigation to better determine the significance and source of the non-stormwater pollutant discharges.

The screening approach is based on the identification and quantification of clean baseflow and the contaminated components during dry weather flows. If the relative amounts of potential components are known, then the importance of the dry weather discharge can be determined. As an example, if a dry weather flow is

mostly uncontaminated groundwater, but contains 5% raw sanitary wastewater, it could still be an important source of pathogenic bacteria.

Tracers can be used to identify relatively low concentrations of important source flows in dry weather flows in storm drains. An ideal tracer should have the following characteristics:

- Significant difference in pollutant concentrations between possible source waters.
- Small variations in pollutant concentrations within each likely source water.
- Conservative behavior (i.e., concentrations do not change due to physical, chemical or biological processes).
- Ease of measurement with adequate detection limits, good sensitivity and repeatability.

## Selection of Possible Tracers of Flow Sources

Table 1 compares the usefulness of candidate tracers to identify different potential non-stormwater flow sources. Generally speaking, natural and domestic waters should be uncontaminated. Sanitary sewage, septage, and industrial source waters can produce toxic or pathogenic conditions. Other source flows, such as wash and rinse waters and irrigation return flows, may cause nuisance conditions, or critically affect aquatic life. Field traces marked by a black circle can probably be used to identify the specific source flows by their presence. White circles indicate that the potential source flow probably will not contain the field tracer, and may help confirm the presence of the source by its absence.

Readers will note that bacteria, specifically the fecal coliform to fecal strep. bacteria ratio (FC/FS), has not been included as a candidate field tracer. Geldreich (1965) proposed this measure as a potential way to identify if a contamination source is human or non-human in origin ( $FC/FS > 4 = \text{Human}$ ;  $< 0.7 = \text{Non-human}$ ). Die-off rates of the component bacteria, however, were found to vary over time and space, making this measure too undependable as tracer for sanitary sewage contamination (see Table 2). There may be some value in investigating specific bacteria types, biotypes or markers, but much care needs to be taken in the analysis and interpretation of the results.

Table 1: Candidate Field Tracers to Identify Flow Sources in Dry Weather Flow

Candidate Tracer	SOURCE WATER							
	Natural water	Potable water	Sanitary sewage	Septage water	Industrial water	Wash water	Rinse water	Irrigation water
Fluoride	○	●	●	●	▲	●	●	●
Hardness change	○	▲	●	●	▲	●	●	○
Surfactants	○	○	●	○	○	●	●	○
Florescence	○	○	●	●	○	●	●	○
Potassium	○	○	●	●	○	○	○	○
Ammonia	○	○	●	●	○	○	○	○
Odor	○	○	●	●	●	▲	○	○
Color	○	○	○	○	●	○	○	○
Clarity	○	○	●	●	●	●	▲	○
Floatables	○	○	●	○	●	▲	▲	○
Deposits and stains	○	○	●	○	●	▲	▲	○
Vegetation change	○	○	●	●	●	▲	○	●
Structural damage	○	○	○	○	●	○	○	○
Conductivity	○	○	●	●	●	▲	●	●
Temperature change	○	○	▲	○	●	▲	▲	○
pH	○	○	○	○	●	○	○	○

Note: ○ implies relatively low concentration; ● implies relatively high concentration; ▲ implies variable conditions

### Tracer Characteristics of Local Source Flows

Table 3 summarizes tracer measurements for Birmingham, Alabama by Pitt *et al.* (1993). It can be viewed as a "library" that describes the tracer conditions for each potential source category. The table includes the median and coefficient of variation (COV) values for each tracer for each source category. The COV is the ratio of the standard deviation to the mean. A low COV value indicates a much smaller spread of data compared to a data set having a large COV value. It is apparent that some of the generalized tracer relationships shown on Table 1 did not always exist during the demonstration project, which stresses the need to obtain local data to develop a local source water library.

Good tracers have significantly different concentrations for each source water category. In addition, effective tracers also need low COV values within each flow category. The study indicated that the COV values were quite low for each category, with the exception of chlorine, which had much greater COV values. Chlorine is therefore not recommended as a quantitative tracer to estimate the flow components. Similar data must be collected in each community where these procedures are to be used. Recommended field observations in-

clude color, odor, clarity, presence of floatables and deposits, and rate of flow, in addition to the chemical tracers shown on Table 3.

### Visual Field Screening

Visual parameters can indicate obvious problems at the stormwater outfall during field screening. These are important because they are the simplest and fastest method to identify grossly contaminated dry weather outfall flows. The visual examination of stormwater outfall characteristics includes unusual flow, odor, color, turbidity and other conditions. Table 4 presents a summary of visual indicators, along with narratives of the descriptors to be selected in the field.

Visual screening methods do not quantify flow components and can result in incorrect determinations (missing outfalls that have important levels of contamination). Visual screenings are most useful for detecting gross contamination. Only the most significant outfalls and drainage areas would therefore be recognized from this method. More intensive chemical tracing is needed to quantify the flow contributions and to identify the less obvious contaminated outfalls.



R0080059

**Table 2: Problems With Using Fecal Coliform to Fecal Strep Ratios to Identify Sources of Bacteria Contamination**

- **Shifting ratios.** Feachem (1975) reported that if bacteria is from human sources, the FC/FS ratio will start out high ( $> 4$ ) and decrease over time. If non-human in origin, the ratio starts out low ( $< 0.7$ ) and increases over time. This shifting ratio problem undermines the usefulness of the FC/FS ratio as an indicator measure for bacteria contamination. Shifting is caused by:
  - **Changing physical and chemical conditions.** Ambient conditions, including water temperature, pH, organic nutrients and toxic metals, affect die-off rates of the component bacteria. (Geldreich, 1965; Geldreich and Kenner, 1969).
  - **Aging.** Geldreich and Kenner (1969) caution that for the FC/FS ratio to be useful, samples must be taken within 24 hours following the deposition of feces. For most sampling programs, the time it takes for bacteria to travel from its point of deposition to the location where sampling occurs is unknown (under both wet and dry weather scenarios). Consequently, it is impossible to determine "freshness" of the bacteria.
  - **Sample location.** Because of the aging problem, samples must be taken relatively near where feces are deposited so that bacteria can be collected as "fresh" samples. Geldreich and Kenner (1969) recommended that samples be taken at wastewater outfalls, since this is where large numbers of fecal organisms recently discharge from warm-blooded animals would be located. Pitt (1983) found that samples collected in runoff source areas usually have the lowest FC/FS ratio in a catchment, followed by urban runoff, and finally the receiving water. In any case, however, there will likely be a mixing of fresh and "not-so-fresh" bacteria which undermines the meaning of the ratio.

Correlation tests were conducted to identify relationships between outfalls that were known to have severe contamination problems and the visual screening indicators (Lalor, 1994). Pearson correlation tests indicated that high turbidity and odors appeared to be the most useful physical indicators of contamination when contamination was defined by toxicity and the presence of detergents

High turbidity was noted in 74% of the contaminated source flow samples, but in only 5% of the uncontaminated source flow samples. This represented a 26% false negative rate (indication of no contamination when contamination actually exists). Noticeable odor was indicated in 67% of flow samples from contaminated sources, but in none of the flow samples from uncontaminated sources. This translates to 33% false negatives, but no false positives. Obvious odors identified included gasoline, oil, sanitary wastewater, industrial chemicals or detergents, decomposing organic wastes, etc.

A correlation was also found to exist between color and Microtox™ toxicity. Color is an important indicator of inappropriate industrial sources, but was also asso-

ciated with some of the residential and commercial flow sources. Color was noted in 100% of the flow samples from contaminated sources, and in 40% of the flow samples from uncontaminated sources. This represents 40% false positives, but no false negatives. Finally, a 63% correlation between the presence of sediments (assessed as settleable solids in the collection bottles of these source samples) and Microtox™ toxicity was also found. Sediments were noted in 34% of the samples from contaminated sources and in none of the samples from uncontaminated sources.

False negatives are more of a concern than a reasonable number of false positives when working with a screening methodology, since they are primarily used to direct further, more detailed investigations. False positives would be discarded after further investigation, but a false negative during a screening investigation results in the dismissal of a problem outfall for at least the near future. Missed contributors to stream contamination may result in unsatisfactory in-stream results following the application of costly corrective measures elsewhere.

#### Detergents as Indicators of Contamination

Lalor (1994) found that samples from dry-weather flow sources could be correctly classified as clean or contaminated based only on the measured value of detergent levels. Research showed that detergents can be used to distinguish between clean and contaminated outfalls simply by their presence or absence, using a detection limit of 0.06 mg/L. Nearly all samples analyzed from contaminated sources contained detergents in excess of this amount. No clean source water samples were found to contain detergents. Contaminated sources would be detected in mixtures with uncontaminated waters if they made up at least 10% of the mixture.

#### Flow Chart for Most Significant Flow Component Identification

The flow chart in Figure 1 describes an analysis strategy which may be used to identify the major component of dry-weather flow samples in residential and commercial areas. This method attempts to distinguish among four major groups of flow: (1) tap waters (including domestic tap water, irrigation water and rinse water), (2) natural waters (spring water and shallow ground water), (3) sanitary wastewaters (sanitary sewage and septic tank discharge), and (4) wash waters (commercial laundry waters, commercial car wash waters, radiator flushing wastes, and plating bath wastewaters). This method not only allows outfall flows to be categorized as contaminated or uncontaminated, but will allow outfalls carrying sanitary wastewaters to be identified. These outfalls should then receive highest priority for further investigation leading to source control. This flow chart was designed for use in residential and/or

Table 3: Chemical Tracer Concentrations Found in Birmingham, Alabama, Waters  
(Mean and Coefficient of Variation, Cov)

Candidate Tracer	Spring water	Treated potable water	Laundry wastewater	Sanitary wastewater	Septic tank effluent	Car wash water	Radiator flush water
Fluorescence (% scale)	6.8 0.43	4.6 0.08	1,020 0.12	250 0.20	430 0.23	1,200 0.11	22,000 0.04
Potassium (mg/L)	0.73 0.10	1.6 0.04	3.5 0.11	6.0 0.23	20 0.47	43 0.37	2,800 0.13
Ammonia (mg/L)	0.009 1.7	0.028 0.23	0.82 0.14	10 0.34	90 0.44	0.24 0.28	0.03 0.3
Ammonia/Potassium (ratio)	0.011 2.0	0.018 0.35	0.24 0.21	1.7 0.31	5.2 0.71	0.006 0.86	0.011 1.0
Fluoride (mg/L)	0.031 0.87	0.97 0.02	33 0.38	0.77 0.23	0.99 0.33	12 0.20	150 0.16
Toxicity (% light decrease after 25 minutes, $I_{25}$ )	<5 n/a	47 0.44	99.9 n/a	43 0.59	99.9 n/a	99.9 n/a	99.9 n/a
Surfactants (mg/L as MBAS)	<0.5 n/a	<0.5 n/a	27 0.25	1.5 0.82	3.1 1.5	49 0.11	15 0.11
Hardness (mg/L)	240 0.03	49 0.03	14 0.57	140 0.11	235 0.64	160 0.06	50 0.03
pH (pH units)	7.0 0.01	6.9 0.04	9.1 0.04	7.1 0.02	6.8 0.05	6.7 0.03	7.0 0.06
Color (color units)	<1 n/a	<1 n/a	47 0.27	38 0.55	59 0.41	220 0.35	3,000 0.02
Chlorine (mg/L)	0.003 1.6	0.88 0.68	0.40 0.26	0.014 1.4	0.013 1.0	0.070 1.1	0.03 0.52
Specific conductivity ( $\mu$ S/cm)	300 0.04	110 0.01	560 0.21	420 0.13	430 0.72	485 0.06	3,300 0.22
Number of samples	10	10	10	36	9	10	10

Note: The fluorescence values are direct measurements from a fluorometers having general purpose filters and lamps and at the least sensitive setting (number 1 aperture). The toxicity screening test results are expressed as the toxicity response noted after 25 minutes of exposure using an Azur Environmental Microtox™ unit which measures toxicity using the light output from phosphorescent algae. The  $I_{25}$  values are the percentage light output decreases observed after 25 minutes of exposure to the sample, compared to a reference. Fresh potable water has a relatively high toxicity response because of the chlorine levels present. Dechlorinated, potable water has much smaller toxicity responses.

R0080061



**Table 4: Visual Tests of Possible Contaminants in Dry Weather Flows**

**Odor** - Most strong odors, especially gasoline, oils, and solvents, are likely associated with high responses on the toxicity screening test. Typical obvious odors include: gasoline, oil, sanitary wastewater, industrial chemicals, decomposing organic wastes, etc.

- *Sewage*: Smell associated with stale sanitary wastewater, especially in pools near outfall.
- *Sulfur ("rotten eggs")*: Industries that discharge sulfide compounds or organics (meat packers, canneries, dairies, etc.).
- *Rancid-sour*: Food preparation facilities (restaurants, hotels, etc.).
- *Oil and gas*: petroleum refineries or many facilities associated with vehicle maintenance or petroleum product storage.

**Color** - Important indicator of inappropriate industrial sources. Industrial dry-weather discharges may be of any color, but dark colors, such as brown, gray, or black, are most common.

- *Yellow*: Chemical plants, textile and tanning plants.
- *Brown*: Meat packers, printing plants, metal works, stone and concrete, fertilizers, and petroleum refining facilities.
- *Green*: Chemical plants, textile facilities.
- *Red*: Meat packers.
- *Gray*: Dairies.

**Turbidity** - Often affected by the degree of gross contamination. Dry-weather industrial flows with moderate turbidity can be cloudy, while highly turbid flows can be opaque. High turbidity is often a characteristic of undiluted dry-weather industrial discharges.

- *Cloudy*: Sanitary wastewater, concrete or stone operations, fertilizer facilities, automotive dealers.
- *Opaque*: Food processors, lumber mills, metal operations, pigment plants.

**Floatable matter** - A contaminated flow may contain floating solids or liquids directly related to industrial or sanitary wastewater pollution. Floatables of industrial origin may include animal fats, spoiled food, oils, solvents, sawdust, foams, packing materials, or fuel.

- *Oil sheen*: Petroleum refineries or storage facilities and vehicle service facilities.
- *Sewage*: Sanitary wastewater.

**Deposits and stains** - Refer to any type of coating near the outfall and are usually of a dark color. Deposits and stains often will contain fragments of floatable substances. These situations are illustrated by the grayish-black deposits that contain fragments of animal flesh and hair which often are produced by leather tanneries, or the white crystalline powder which commonly coats outfalls due to nitrogenous fertilizer wastes.

- *Sediment*: Construction site erosion.
- *Oily*: petroleum refineries or storage facilities and vehicle service facilities.

**Vegetation** - Vegetation surrounding an outfall may show the effects of industrial pollutants. Decaying organic materials coming from various food product wastes would cause an increase in plant life, while the discharge of chemical dyes and inorganic pigments from textile mills could noticeably decrease vegetation. It is important not to confuse the adverse effects of high stormwater flows on vegetation with highly toxic dry-weather intermittent flows.

- *Excessive growth*: Food product facilities.
- *Inhibited growth*: High stormwater flows, beverage facilities, printing plants, metal product facilities, drug manufacturing, petroleum facilities, vehicle service facilities and automobile dealers.

**Damage to Outfall Structures** - Another readily visible indication of industrial contamination. Cracking, deterioration, and spalling of concrete or peeling of surface paint, occurring at an outfall are usually caused by severely contaminated discharges, usually of industrial origin. These contaminants are usually very acidic or basic in nature. Primary metal industries have a strong potential for causing outfall structural damage because their batch dumps are highly acidic. Poor construction, hydraulic scour, and old age may also adversely affect the condition of the outfall structure.

- *Concrete cracking*: Industrial flows
- *Concrete spalling*: Industrial flows
- *Peeling paint*: Industrial flows
- *Metal corrosion*: Industrial flows

**R0080062**

commercial areas only, and investigations in industrial or industrial/commercial land use areas must be approached in an entirely different manner (EPA, 1983).

In residential and/or commercial areas, all outfalls should be located and examined. The first indicator is the presence or absence of dry-weather flow. If no dry-weather flow exists at an outfall, then indications of intermittent flows must be investigated. Specifically, stains, deposits, odors, unusual streamside vegetation conditions, and damage to outfall structures can all indicate intermittent non-stormwater flows. However, frequent visits to outfalls over long time periods, or the use of other monitoring techniques, may be needed to confirm that only stormwater flows occur. If intermittent flow is not indicated, then the outfall probably does not have a contaminated non-stormwater source.

If dry-weather flow exists at an outfall, then the flow should be sampled and tested for detergents. If detergents are not present, the flow is probably from a non-contaminated non-stormwater source. The lower limit of detection for detergent should be about 0.06 mg/L.

If detergents are not present, fluoride levels can be used to distinguish between flows with treated water sources and flows with natural sources in communities where water supplies are fluoridated and natural fluoride levels are low. In the absence of detergents, high fluoride levels would indicate a potable water line leak, irrigation water, or wash/rinse water. Low fluoride levels would indicate waters originating from springs or shallow groundwater. Based on the flow source samples tested in this research (Table 3), fluoride levels above 0.13 mg/L would most likely indicate that a tap water source was contributing to the dry-weather flow in the Birmingham, Alabama study area.

If detergents are present, the flow is probably from a contaminated non-stormwater source, as indicated on Table 3. The ratio of ammonia to potassium can be used to indicate whether or not the source is sanitary wastewater. Ammonia/potassium ratios greater than 0.60 would indicate likely sanitary wastewater contamination. Ammonia/potassium ratios were above 0.9 for all septic and sewage samples collected in Birmingham (values ranged from 0.97 to 15.37, averaging 2.55). Ammonia/potassium ratios for all other samples containing detergents were below 0.7, ranging from 0.00 to 0.65, averaging 0.11.

Non-contaminated source water samples collected in Birmingham had ammonia/potassium ratios ranging from 0.00 to 0.41, with a mean value of 0.06 and a median value of 0.03. Using the mean values for non-contaminated samples (0.06) and sanitary wastewaters (2.55), flows comprised of mixtures containing at least 25% sanitary wastes with the remainder of the flow from uncontaminated sources would likely be identified as sanitary wastewaters using this method (Table 5). Flows containing smaller percent contributions from sanitary

wastewaters might be identified as having a wash water source, but would not be identified as uncontaminated.

### Summary

Tracers can be an important screening tool to detect bacterial and other contaminant sources to urban storm drainage systems. These tracers provide a method of identifying contaminated dry-weather flows in the field with a minimum of effort and expense. Those outfalls that are labeled as containing potential sources through this field screening would then receive a more intensive analysis to accurately pinpoint the specific sources contributing pollutant discharges. To be effective, a tracer needs to be easy to detect, not subject to substantial changes due to biological or chemical processes, and have concentration levels that vary significantly between possible pollutant sources but vary little within each source category.

Several visual criteria appear to function quite well as negative indicators of severe outfall contamination. These visual indicators provide a simple method of identifying grossly contaminated dry-weather outfall flows for field screening. The two most useful of these physical indicators are turbidity and odor. These two indicators had the highest correlation and smallest number of false negative results of all the parameters tested during examinations of contaminated and uncontaminated flows. Research also indicates that the presence of detergents is the most useful chemical indicator for distinguishing between contaminated and uncontaminated flows.

For the watershed manager, the detection of contaminant sources is a necessity in creating effective water quality plans. By providing a means of screening dry-weather flows for potential sources, tracers and negative indicators allow managers to direct source control planning measures in a more cost-effective and efficient way. The identification of the most significant components of flow permits watershed professionals to prioritize specific outfalls for more intensive investigation, thus providing a way to supply maximum treatment with limited staff and budget resources.

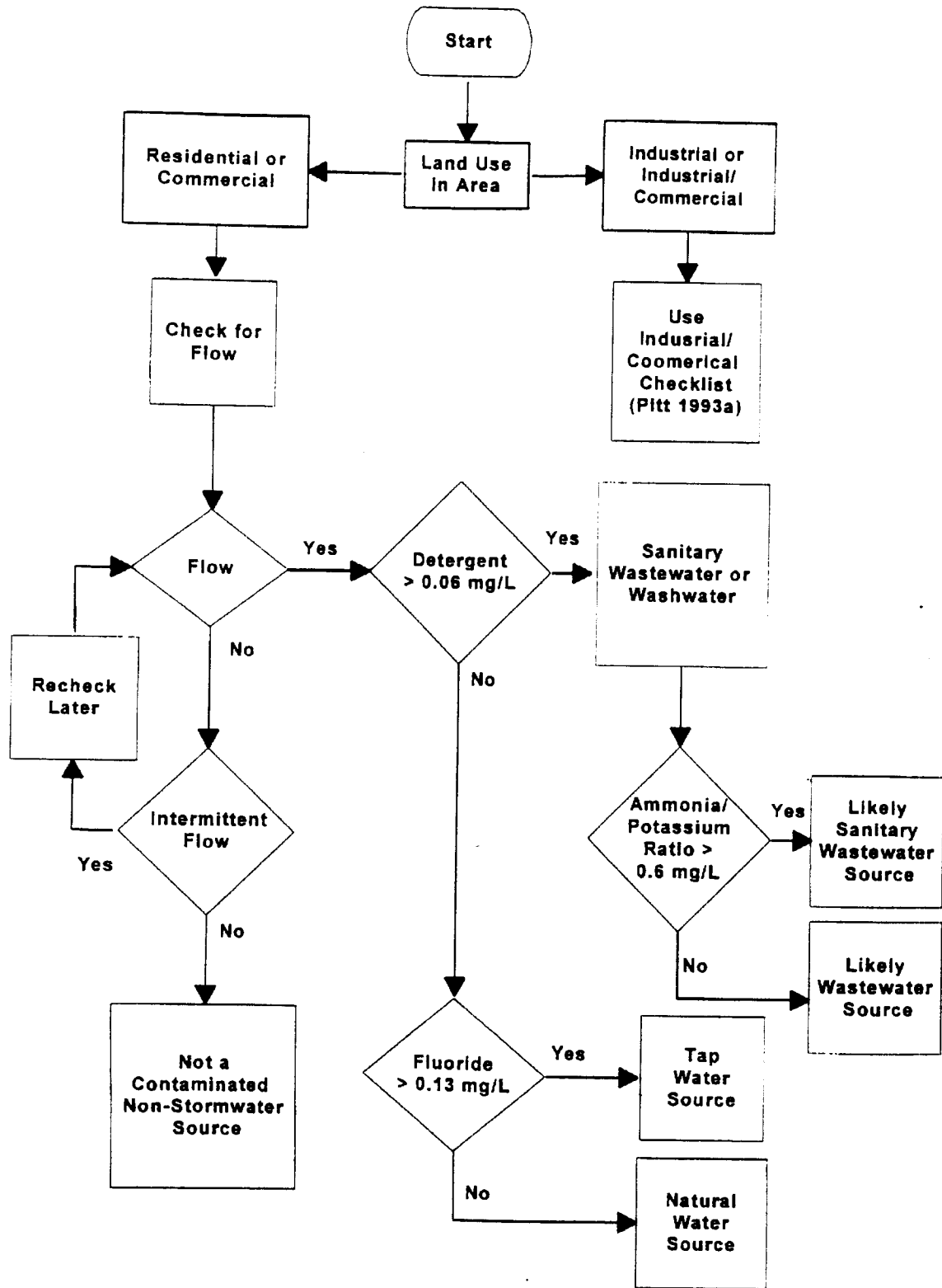

Figure 1: Flow Chart Methodology for Identifying Most Significant Flow Component (Lalor, 1993)

**Table 5: Tracers for Identifying Treated Potable Water and Sanitary Wastewater**

**Treated Potable Water**

- Variations in major ions or other chemical/physical characteristics of the flow components may exist, depending upon whether the water supply sources are groundwater or surface water, and whether the sources are treated or not. Specific conductance may also serve as an indicator of the major water source.
- Hardness may be used as an indicator if the potable water source and the baseflow are from different water sources.
- If the concentration of chlorine is high, then a major leak of disinfected potable water is likely close to the outfall. Due to the rapid loss of chlorine in water (especially if some organic contamination is present) it is not a good parameter for quantifying the amount of treated potable water at an outfall.
- Fluoride can often be used to separate treated potable water from untreated water sources. If the treated water has no fluoride added, or if the natural water has fluoride concentrations close to potable water fluoride concentrations, then fluoride may not be an appropriate indicator. If the drainage area has industries that have their own water supplies (quite rare for most urban drainage areas), then further investigations such as toxicity screening are needed to check for industrial non-stormwater discharges.

**Sanitary Wastewaters**

- Surfactant (detergent) analyses may be useful in determining the presence of sanitary wastewaters. However, the presence of surfactants could also indicate laundry wastewaters, car washing wastewater, or other industrial or commercial process waters.
- The presence of fabric whiteners (as measured by fluorescence) may distinguish laundry and sanitary wastewaters.
- Sanitary wastewaters often exhibit predictable trends during the day in flow and quality. In order to maximize the ability to detect direct sanitary wastewater, it would be best to survey the outfalls during periods of highest sanitary wastewater flows (mid to late morning hours).
- The ratio of surfactants to ammonia or potassium concentrations may be an effective indicator. If the surfactant concentrations are high, but the ammonia and potassium concentrations are low, then the contaminated source may be laundry wastewaters. Conversely, if ammonia, potassium, and surfactant concentrations are all high, then sanitary wastewater is the likely source. Low surfactants concentrations and high potassium and ammonia concentrations may be characteristic of septic tank effluents, but must be confirmed by local characterization data for potential contaminating sources.

**References**

- Feachem, R. 1975. "An Improved Role for Fecal Coliform to Fecal Streptococci Ratios in the Differentiation Between Human and Non-Human Pollution Sources." *Water Research* 9:689-690.
- Geldreich, E.E. 1965. "Origins of Microbial Pollution in Streams." *Transmission of Viruses by the Water Route*, ed. G. Berg. Interscience publishers, NY.
- Geldreich, E.E. and B.A. Kenner. 1969. "Concepts of Fecal Streptococci in Stream Pollution." *Journal WPCF*, 41(8):R336-R352.
- Lalor, M. 1994. *Assessment of Non-Stormwater Discharges to Storm Drainage Systems in Residential and Commercial Land Use Areas*. Ph.D. dissertation. Dept. of Environmental and Water Resources Engineering, Vanderbilt Univ. Nashville, TN. 256 pp.
- Pitt, R. 1983. *Urban Bacteria Sources and Control by Street Cleaning in the Lower Redeau River Watershed*. Redeau River Stormwater Management Study, Ontario Ministry of the Environment, Ottawa.
- Pitt, R. and J. McLean. 1986. *Humber River Pilot Watershed Project*. Ontario Ministry of the Environment, Toronto. 483 pp.
- Pitt, R., M. Lalor, R. Field, D.D. Adrian and D. Barbel. 1993. *A User's Guide for the Assessment of Non-Stormwater Discharges Into Separate Storm Drainage Systems*. EPA/600-R-92-238. Risk Reduction Engineering Lab., USEPA, Cincinnati.
- USEPA. 1983. *Results of the Nationwide Urban Runoff Program*. PB 84-185552, Water Planning Division, U.S. Environmental Protection Agency, Washington DC.

**R0080065**



9

R0080066

# Section 10: Watershed Stewardship

## Watershed Protection Tool #8

The purpose of watershed stewardship is to take care of a watershed after it has been developed. Watershed managers should consider at least six basic programs to promote stronger watershed stewardship. These stewardship programs include watershed education, watershed advocacy, pollution prevention in the home, pollution prevention at work, watershed monitoring, and stream restoration.

1. *Watershed education:* Watershed education is the foundation of watershed stewardship, and we must always keep in mind that less than half of the public understands the watershed concept. Therefore, the basic message of watershed stewardship—that we live in a watershed and must learn how to live within it—must be effectively and repeatedly delivered to watershed residents. Some interesting research on the best techniques for delivering the watershed education message can be found in papers 126 and 127.

2. *Watershed advocacy:* One of the most important investments a community can make in regard to stewardship is to seed and support a watershed organization to carry out the long-term stewardship function (see article 128). Nonprofits are particularly suited to handle the stewardship role, given their watershed focus, volunteers, low cost, and ability to reach out to the community. Watershed organizations can also provide a forum where a broad group of stakeholders can come together. A diverse range of people has a stake in protecting or restoring watersheds, although they may not yet realize it. Key stakeholders include the general public, lawn owners, landowners, business owners, pet owners, recreational allies, elected officials, stream “watchers,” government agencies, neighborhood or civic associations, utility ratepayers, development professionals (planners, engineers, contractors, builders, landscape architects), fishermen, developers, and school kids. Local government officials must also play a strong role in watershed stewardship, not only as patrons or sponsors of the watershed organization, but also taking leadership in watershed maintenance, monitoring, and restoration.

3. *Pollution prevention at home:* Many of the individual actions we take in our daily lives can strongly influence the quality of a watershed. Surveys suggest that we engage in numerous behaviors that can adversely impact water quality, as described in article 126. One promising area where we can practice better stewardship is on our own little piece of the watershed, our lawns and yard. Five articles (129 to 133) summarize research on the links between lawn care and stream quality, and set forth guidelines on how a healthy lawn can be maintained with little or no input of fertilizers, pesticides or irrigation water.

4. *Pollution prevention at work:* Certain areas of a watershed are known as stormwater hot spots, in that they produce higher concentrations of harmful pollutants than typical development. Examples of hot spots include gas station, junkyards, areas of heavy industry, and major highways. In many cases, pollutant runoff from these hot spots can be sharply reduced if workers understand how to safely handle potential pollutants and prevent their exposure to rainfall. Often, watershed businesses may need special training on how to manage their operations to prevent pollution. Many communities are responsible for developing pollution prevention programs at certain types of businesses and industries, under industrial or municipal NPDES stormwater regulations. Some case studies in pollution prevention are provided in articles 136 to 140.



"A watershed manager looks to stormwater treatment to solve many different problems caused by runoff."

R0080067

5. *Watershed monitoring:* Monitoring is essential to track the health of an urban watershed over time, as well as to gauge how well watershed protection practices are working to meet watershed goals. A single article (141) reviews some of the more useful options to develop an effective watershed monitoring program.

6. *Stream restoration:* The last element of stewardship is a commitment to restore streams damaged by past development. In recent years, a new practice has evolved known as watershed restoration, which is still as much an art as a science. The last nine articles in this book (142 to 150) describe some of the techniques that are being applied to repair damaged streams and watersheds.

#### *Stewardship Trends in the Last Decade*

The last decade was a very fertile one for watershed stewardship, as demonstrated by the 25 articles presented here. To a great extent, this was due to the rapid growth in watershed organizations and governmental committees that promote better stewardship of our urban watersheds. In 1990, only a handful of these organizations existed; today the number has grown to several thousand. Together, these organizations have experimented with hundreds of different methods to educate, advocate, monitor and restore urban streams, and to generally promote a watershed ethic.

We are now entering a phase where we are trying to sort the stewardship methods that really work from those that do not. It is always a challenge to measure the precise benefits of different stewardship methods in a given watershed, but we are gradually acquiring more hard data on watershed behaviors, learning preferences, stream restoration practices, and workable pollution prevention programs. Such information is urgently needed to improve the practice, and make better choices on our stewardship investments. Resources for stewardship will always be scarce, so communities need to invest wisely in their stewardship programs.

Even as the practice of stewardship becomes more professional and even scientific, it is very important to remember that watershed stewardship will always be a highly personal affair. Nothing can ever replace our deeply rooted and emotional relationship to the land that is at the core of our practice. And further progress is not likely until we can skillfully communicate to others why we care so much about watersheds. In order to protect our watersheds, we need passion as well as practices, equal doses of celebration and science, and most of all, a personal ethic for living in and caring for the watershed.

## **Watershed Stewardship Contents**

### *Watershed Education*

126.	Understanding Watershed Behavior .....	621
127.	On Watershed Education .....	629

### *Watershed Advocacy*

128.	Choosing the Right Watershed Management Structure .....	639
------	---	-----

### *Pollution Prevention at Home*

129.	The Peculiarities of Perviousness .....	649
130.	Toward a Low Input Lawn .....	655
131.	Homeowner Survey Reveals Lawn Management Practices in Virginia .....	666
132.	Nitrate Leaching Potential From Lawns and Turfgrass .....	668
133.	Insecticide Impact on Urban Wildlife .....	670
134.	Minimizing the Impact of Golf Courses on Streams .....	673
135.	Groundwater Impacts of Golf Course Development in Cape Cod .....	676

**R0080068**

*Pollution Prevention at Work*

136.	Practical Pollution Prevention Practices Outlined for West Coast Service Stations .....	681
137.	Practical Pollution Prevention Emphasized for Industrial Stormwater .....	682
138.	Milwaukee Survey Used to Design Pollution Prevention Program .....	684
139.	Rating Deicing Agents: Road Salt Stands Firm .....	686
140.	Pollution Prevention for Auto Recyclers .....	690

*Watershed Monitoring*

141.	An Introduction to Stormwater Indicators .....	695
------	--	-----

*Stream Restoration*

142.	Assessing the Potential for Urban Watershed Restoration .....	705
143.	Stormwater Retrofits: Tools for Watershed Enhancement .....	712
144.	Sligo Creek: Comprehensive Stream Restoration .....	716
145.	Bioengineering in Four Mile Run, Virginia .....	722
146.	Coconut Rolls Used For Natural Streambank Stabilization .....	725
147.	Pipers Creek: Salmon Habitat Restoration in the Pacific Northwest .....	728
148.	The Longevity of Instream Habitat Structures .....	731
149.	Stream Daylighting in Berkeley, CA Creek .....	733
150.	Parallel Pipe Systems as a Stream Protection Technique .....	737



R0080070

# Understanding Watershed Behavior

*In short, twenty centuries of progress have brought the average citizen a vote, a national anthem, a Ford, a bank account, and a high opinion of himself, but not the capacity to live in high density without befouling and denuding his environment...Nor a conviction that such capacity, rather than such density, is the true test of whether he is civilized.* Aldo Leopold (1933), *Game Management*

Since Leopold wrote these words in 1933, over 50 million new households have formed in America. By conservative estimates, we have added 45 million yards, 125 million cars and trucks, 15 million septic systems, and 25 million dogs during the last half century. In his time, Aldo Leopold imagined that the foremost practitioner of the land ethic would be the farmer, the game warden or perhaps the woodlot owner. He simply could not have envisioned that the most important practitioner would ultimately become the suburban and rural landowner, who individually lords over a few hundred square feet, but cumulatively dominates the watershed.

It is a maxim of watershed science that each of us is personally responsible for contributing some of the pollutants that run off our lawns, streets and parking lots. Runoff pollution is the major cause of water quality problems in most urban watersheds. While runoff pollution is not usually sudden or dramatic, it leads to the gradual degradation of urban waters—degraded streams, eutrophic lakes, closed beaches and shellfish beds, and polluted drinking water supplies.

It is a curious tendency of our species, however, that when we study urban watersheds, we rarely study ourselves, despite the fact that these watersheds are our primary habitat. We seldom take the trouble to measure the cumulative impact of our individual behaviors on the watershed. In this article, we summarize our sketchy understanding of human behaviors in suburban and rural watersheds, based on an analysis of over twenty recent surveys of watershed residents. These surveys asked residents about their basic behaviors in six broad areas: lawn fertilization, pesticide application, dog walking, septic cleaning, car washing, and fluid changing. Prior research indicates that each of these behaviors are common in most watersheds and can have a strong impact on water quality.

Our early experience in trying to restore urban watersheds suggests that we can never meet our water quality goals for streams, lakes and estuaries until we can convince urban, suburban and rural landowners to change their behaviors and practice a better watershed ethic. Such a watershed ethic is critical if we are to protect or improve the quality of our urban watersheds. The article concludes by outlining some of the possible elements of a watershed ethic that might guide the actions of suburban and rural landowners.

The six watershed behaviors profiled in this article are not the only ones that can have a strong influence on watershed quality, but they are the ones we happen to know the most about. Other individual behaviors that can influence water quality are listed in Table 1.

The frequency of any individual behavior can differ from watershed to watershed, based on population density and the level of income, education, and awareness of its residents. What is particularly troubling, however, is that many of the most potentially polluting behaviors are practiced by affluent, well-educated and environmentally aware members of our society. These behaviors are rooted in our collective desire for a clean, well-manicured and tidy suburban environment—a nice green lawn, a shiny car, a pest-free yard or a clean driveway. Indeed, many watershed behaviors have become worse in recent years, driven by the rapid growth in the tools and products to improve and beautify the suburban landscape.

## Lawn Fertilization

It has been estimated that there are 25 to 30 million acres of turf and lawn in the United States (Robert and

**Table 1: Other Key Individual and Household Behaviors that Potentially Influence Watersheds**

- Leaf Disposal/Composting
- Disposal of Household Hazard Wastes
- Hosing and Power-washing
- Landscaping Practices
- Car Emissions Testing
- De-icing
- Watering/Irrigation
- Sidewalk/Driveway Sweeping
- Maintenance of Common Stormwater Facilities and Conservation Areas

Roberts, 1989. Lawn and Landscape Institute, 1999). To put this statistic in perspective, consider that if lawns were classified as a crop, they would rank as the fifth largest in the country on the basis of area, after corn, soybeans, wheat, and hay (USDA, 1992). In terms of fertilizer inputs, nutrients are applied to lawns at about the same application rates as those used for row crops (Barth, 1995a).

Research has indicated that nutrient runoff from lawns has the potential to cause eutrophication in streams, lakes, and estuaries (see Schueler, 1995b). Nutrient loads generated by suburban lawns can be significant, since recent research has shown that lawns produce more surface runoff than previously thought (see article 36).

Lawn fertilization is among the most widespread watershed behaviors we engage in. In our survey of resident attitudes in the Chesapeake Bay, 89% of citizens owned a yard, and of these, about 50% applied fertilizer every year (Swann, 1999). The average rate of

fertilization in 10 other resident surveys was even higher, at 78%, although this could reflect the fact that these surveys were biased towards predominantly suburban neighborhoods, or excluded non-lawn owners (Table 2).

Several studies have measured the frequency with which we fertilize our yards. In the Chesapeake Bay survey, fertilizers were applied almost twice a year (1.7) with spring and fall being the most popular seasons for fertilization. In five other surveys, fertilizers were applied an average of 2.3 times year, and most frequently in the spring. It should be noted that the spring is not considered an optimal season to apply fertilizers from an agronomic standpoint.

A significant fraction of homeowners can be classified as "over-fertilizers" who apply fertilizers to their lawns two or more times a year. In the Chesapeake Bay survey, over-fertilizers comprised 52% of all those that applied fertilizers to their yard. Other studies have put the number of over-fertilizers at 65% to 70% of all

Table 2: Lawn Care Practices - A Comparison of 11 Homeowner Surveys

Study	Respondents	% Fertilizing	% Soil Testing	Other Notes
Chesapeake Bay Swann, 1999	656	50%	16%	1.73 times/year
Maryland Smith, 1996	100	88%	15%	58% grasscycle
Maryland Kroll and Murphy, 1994	403	87% *	na	
Virginia, Aveni, 1998	100	79%	> 20%	
Maryland, HGIC, 1996	164	73%	na	2.1 times/year
Michigan, De Young, 1997	432	75%	9%	1.9 times/year 69% grasscycle
Minnesota Morris and Traxler, 1996	981	75%	12%	2.1 times/year 40% grasscycle
Minnesota, Dindorf, 1992	136	85%	18%	78% grasscycle
Wisconsin, Kroupa, 1995	204	54%	na	2.4 times/year
Washington, Hardwick, 1997	406	67%	na	
Florida, Knox et al., 1995	659	82%	na	3.2 times/year 59% grass cycle

\* Fertilization rates were significantly lower in small urban lots (less than 2500 square feet); survey results from these smaller lots were excluded from this table.  
na = not asked

fertilizers (Morris and Traxler, 1996; Knox *et al.*, 1995). Clearly, many homeowners, in a quest for quick results or a bright green lawn, are applying more nutrients to their lawns than they actually need.

From a demographic standpoint, the primary fertilizer is a middle-aged man in the 45-54 age group (BHI, 1997). These individuals place a very high value on lawns. For example, when residents were asked their opinions on over 30 statements about lawns in a Michigan survey, the most favorable overall response was to the statement "a green attractive lawn is an important asset in a neighborhood" (De Young, 1997). Nationally, homeowners spend about 27 billion dollars each year to maintain their own yard or pay someone else to do it (PLCAA, 1999). In terms of labor, a majority of homeowners spend more than an hour a week taking care of the lawn (Aveni, 1994; De Young, 1997).

Unlike farmers, suburban and rural landowners are often ignorant of the actual nutrient needs of their lawns. According to surveys, only 10 to 20% of lawn owners take the trouble to perform soil tests to determine whether fertilization is even needed (Table 2). The majority of lawn owners are not aware of the phosphorus or nitrogen content of the fertilizer they apply (Morris and Traxler, 1996) or that leaving grass clippings on the lawn can reduce or eliminate the need to fertilize.

Our ignorance about lawn nutrients is not surprising given where we get our information on lawn care. Study after study indicates that product labels, store attendants and lawn care companies are the primary and almost exclusive source of lawn care information for the average consumer. Consumers also rely on direct mail and word of mouth as the primary factor when choosing a lawn care company (Swann, 1999; AMR, 1997).

Not many residents understand that lawn fertilizer can cause water quality problems—overall less than one fourth of residents rated it as a water quality concern (Syferd, 1995; Assing, 1994), although ratings were as high as 60% for residents living adjacent to lakes (Morris and Traxler, 1996; MCSR, 1997). Interestingly, in one Minnesota survey, only 21% of homeowners felt their own lawn contributed to water quality problems, while over twice as many felt their neighbor's lawn did (MCSR, 1997).

In recent years, many communities have attempted to educate residents about lawn care and nutrients. The education message they send, however, is often ambiguous and complex, and typically is geared more to better turf management than better water quality. This is evident in outreach materials that consistently promote a message to use less fertilizer, fertilize in the right season, test soils, use slow-release fertilizer or grass-cycle and keep clippings on lawn. This educational approach sometimes requires residents to understand a lot more about nutrient management than they can

read off a label.

Conspicuously absent is a much stronger message that promotes a low or zero input lawn. It seems appropriate that watershed education programs strongly advocate no chemical fertilization, reduced turf area and the use of native plants adapted to the ecoregion (Barth, 1995), if only to balance the pro-fertilization message that is so effectively marketed by the lawn care industry.

### Pesticide Application

When Rachel Carson first wrote *Silent Spring*, many Americans were alerted to the dangers of pesticides in the urban environment. Yet, pesticides are still frequently found in the waters of many urban streams, in settings as diverse as Georgia, Texas, California, Maryland, and Wisconsin. The pesticides of greatest concern are insecticides, such as diazinon and chloropyrifos, and a group of herbicides (CWP, 1999; Schueler, 1995a). Even very low levels of these pesticides can be harmful to aquatic life. The major source of pesticides in urban streams are home applications to kill insects and weeds in the lawn and garden. Table 3 compares surveys on residential pesticide use in 11 different regions of the country in terms of insecticides and herbicides. At first glance, it appears that pesticide application rates vary greatly, ranging from a low of 17% to a high of 87%.

Some patterns do emerge, however. For example, insecticides tend to be applied more widely in warm weather climates where insect control is a year-round problem (such as Texas, California, and Florida). Anywhere from 50 to 90% of residents reported that they had applied insecticides in the last year in warm-weather areas. This can be compared to 20 to 50% levels of insecticide use reported in colder regions where hard winters can help keep insects in check.

In contrast, herbicide application rates tend to be higher in cold weather climates to kill the weeds that arrive with the onset of spring (60 to 75% in the Michigan, Wisconsin and Minnesota surveys). Resident surveys also indicate that many residents lack awareness that their lawn care program actually uses herbicides. This confusion stems from the recent growth of "weed and feed" lawn care products that combine weed control and fertilization in a single bag. In one Minnesota study, 63% of residents reported that they used weed and feed lawn products, but only 24% understood that they were applying herbicides to their lawn (Morris and Traxler, 1996). In addition, many residents are unaware of the pesticide application practices that their lawn care company applies to their yard, preferring to leave it up to the professionals (Knox *et al.*, 1995).

The widespread use of pesticides on urban lawns and gardens is somewhat curious since surveys tell us that the public has a reasonably good understanding of the potential environmental dangers of pesticides. Several surveys indicate that residents do understand envi-

**Table 3: A Comparison of 11 Surveys of Residential Insecticide and Weedkiller Use**

Study	N	Region	Use Insecticides	Use Herbicides	Notes
Chesapeake Bay Swann, 1999	656	#	21%	--	70% use private sector info
Maryland Kroll and Murphy, 1994	403	#	42%	32%	
Virginia Aveni, 1998	100	#	66%	--	
Maryland, Smith, 1994	100	#	23%	n/a	55% use product labels
Minnesota, Morris and Traxler, 1997	981	C	--	75%	1.3 times/year
Michigan, De Young, 1997	432	C	40%	59%	
Minnesota, Dindorf, 1992	136	C	--	76%	
Wisconsin, Kroupa, 1995	204	C	17%	24% **	63% use a weed and feed product
Florida, Knox et al., 1995	659	W	83%	--	
Texas, NSR, 1998	350	W	87%	--	
California, Scanlin and Cooper, 1997	600	W	50%	--	

( # ) Mid-Atlantic surveys, ( C ) Cold-weather surveys ( W ) Warm-weather surveys  
 ( \*\* ) Note difference in self reported herbicide use and those that use a weed and feed product.

ronmental concerns about pesticides and consistently rank them as the leading cause of pollution in the neighborhood (Elgin, 1996).

The education message sent about pesticides is often very complex. Outreach materials often promote a message to use less pesticides, apply them properly or practice integrated pest management. This approach requires residents to understand a lot more about pesticides than they are likely to read off a product label. As was the case with fertilizer, product labels are the primary and often dominant source of information about pesticides. Nearly 90% of homeowners rely on commercial sources of information to guide their pesticide use (Swann, 1999). From a watershed standpoint, it may be wise to articulate a simple but strong message that pesticides should be applied only as a last resort, or not at all.

**Dog Walking**

One biological index that never declines after a watershed develops is the dog population. In our survey of Chesapeake Bay residents, we found about 40% of households own a dog. A dog owner, however, is not always a dog walker. Just about half of all dog owners actually walk their dog. Of the half that do walk their dog, about 60% claim to pick up after their dog (Swann, 1999), which is generally consistent with other studies (Table 4). Men are also prone to pick up after their dog less often than women (Swann, 1999). The virtuous dog walkers that clean up after their dogs usually dispose of the fecal matter in the trash can, toilet, compost pile or down a storm drain inlet (Hardwick, 1997; HGIC, 1998).

Failure to clean up after a dog can cause both water quality and public health problems, and many commu-

**Table 4: A Comparison of Three Resident Surveys About Cleaning Up After Dogs**

Maryland HGIC, 1996	62% always cleaned up after the dog; sometimes 23%; never 15%. Disposal method: trash can (66%); toilet (12%); other 22%
Washington Hardwick, 1997	Pet ownership 58% 51% of dog owners do not walk dogs 69% claimed that they cleaned up after the dog 31% do not pick up Disposal methods: trash can 54%; toilet 20%; compost pile 4% 4% train pet to poop in own yard 85% agreed that pet wastes contribute to water quality problems
Chesapeake Bay Swann, 1999	Dog ownership 41% 44% of dog owners do not walk dogs Dog walkers who clean up most/all of the time 59% Dog walkers who never or rarely clean up 41% Of these, 44% would not clean up even with fine, complaints, collection or disposal methods 63% agreed that pet wastes contribute to water quality problems

nities have responded by adopting "pooper scooper" laws. Dogs have been found to be a major source of fecal coliform and pathogens in many urban watersheds (Schueler, 1999), which is not surprising given their population, daily defecation rate, and bacteria/pathogen production.

Residents seem to be of two minds when it comes to dog waste. While a strong majority agree that dog waste can be a water quality problem (Hardwick, 1997; Swann, 1999), they generally rank it as the least important local water quality problem (Syferd, 1995; MSRC, 1997). This finding strongly suggests the need to dramatically improve watershed education efforts to increase public recognition about the water quality and health consequences of dog waste.

It is worth noting that many residents are very reluctant to change the way they handle dog waste. According to the Chesapeake Bay survey, 44% of dog walkers who do not pick up indicated they would still refuse to pick up even if confronted by complaints from neighbors or fines, or provided with more sanitary and convenient options for retrieving and disposing of dog waste. Table 5 lists factors that compel residents to pick up after their dog, along with some interesting rationalizations for not doing so.

This strong resistance to handling dog waste suggests that an alternative message may be necessary: to practice rudimentary manure management by training dogs to use areas that are not hydraulically connected to the stream or close to a buffer.

**Car Washing**

Outdoor car washing has the potential to result in high loads of nutrients, metals and hydrocarbons during dry weather conditions in many watersheds, when the detergent-rich water used to wash the grime off our cars flows down the street and into the storm drain. Not

much is known about the water quality of car wash water, but it is very clear that car washing is a common watershed behavior. Three recent surveys have asked residents where and how frequently they wash their cars (Table 6).

According to the surveys, roughly 55 to 70% of households wash their own cars, with the remainder using a commercial car wash. A full 60% of residents could be classified as "chronic car-washers," i.e., they wash their car at least once a month (Smith, 1996; Hardwick, 1997). Between 70 and 90% of residents reported that their car wash-water drained directly to the street, and presumably, to the nearest stream.

Residents are typically not aware of the water quality consequences of car washing, and do not understand the chemical content of the soaps and detergents they use. Car washing is also a very difficult watershed behavior to change, since it is hard to define a better alternative without asking people to pay to use

**Table 5: Dog Owners' Rationale for Picking Up or Not Picking Up After Their Dog (HGIC, 1996)**

<u>Reasons for not picking it up:</u>	<u>Reasons for picking up:</u>
Because it eventually goes away	It's the law
Just because	Environmental reasons
Too much work	Hygiene/health reasons
On edge of my property	Neighborhood courtesy
It's in my yard	It should be done
It's in the woods	Keep the yard clean
Not prepared	
No reason	
Small dog, small waste	
Use as fertilizer	
Sanitary reasons	
Own a cat or other kind of pet	

**Table 6: A Comparison of Three Surveys About Car Washing**

Study	Car Washing Behavior
Maryland <i>Smith, 1996</i>	60% washed car more than once a month
California <i>Pellegrin, 1998</i>	73% washed their own cars 73% report that wash-water drains to pavement
Washington <i>Hardwick, 1997</i>	56% washed their own cars 44% used commercial car wash 91% report that wash-water drains to pavement 56% washed car more than once a month 50% would shift if given discounts or free commercial car washes

a commercial car wash that treats its wash water. Some potential alternative messages that might work are to wash cars less frequently, wash them on grassy areas, and to buy phosphorus-free detergents and non-toxic cleaners.

#### Fluid Changing

Dumping automotive fluids down storm drains can be a major water quality problem, since only a few quarts of oil or a few gallons of anti-freeze can have a major impact on small streams and wetlands during low flow conditions. Historically, the major culprit has been the backyard mechanic who changes his or her own automotive fluids. The number of backyard mechanics who change the oil and antifreeze in their cars, however, has been dropping steadily in recent decades. With the advent of the \$20 oil change special, only about 30% of car owners change their own oil or anti-freeze anymore (Table 7).

Backyard mechanics have traditionally been the target of community oil recycling and storm drain stenciling programs. These programs appear to have been quite effective, since over 80% of backyard mechanics claim to dispose or recycle these fluids properly. Most backyard mechanics are more prone to recycle oil than antifreeze, and of those that have improperly disposed of either fluid, most used the trash can rather than the storm drain. It is important to keep in mind that any self-reported information on dumping or disposal methods needs to be taken with a grain of salt, given that people often feel the need to give the socially accepted or expected survey response. Nevertheless, it does seem clear that the previous watershed education efforts have made oil and antifreeze dumping socially unacceptable. By our estimates, only one to five percent of the general population now engages in such behavior.

#### Septic System Maintenance

About one in four American households relies on septic systems to dispose of their wastewater. Depending on soil conditions and other factors, septic systems have a failure rate ranging from five to 35%, with failure discharging untreated or partially treated wastewater into groundwater (Schueler, 1999). Even properly operating septic systems produce elevated nutrient levels in shallow groundwater, which can degrade coastal and lake water quality (Ohrel, 1995).

Until recently, homeowner awareness about septic system maintenance was poorly understood. The Chesapeake Bay survey was one of the first to examine how frequently residents maintain their septic systems. An interesting finding from the survey was the advanced age of the average septic system in the ground: about 27 years, or about seven years beyond the design life of an unmaintained system. Roughly half of the owners were classified as "septic slackers," as they indicated that they had not inspected or cleaned out their system in last three years (which is the minimum recommended frequency).

Septic systems are a classic case of "out of sight, out of mind." A small but significant fraction (12%) of septic system owners had no idea where their septic system was located on their property. In addition, only 42% of septic system owners had ever requested advice on how to maintain their septic system, and these owners relied primarily on the private sector for this advice (e.g., pumping service, contractors, and plumbers). Like many other watershed behaviors, there was a sharp difference between resident attitudes and their actual practice. For example, while 70% of septic system owners agreed with the statement that "inspection and routine clean out of septic systems is necessary to protect water quality in the Chesapeake Bay," more than half had not done so in the last three years (Swann, 1999).

A key element of the watershed ethic involves taking personal responsibility for the quality of home wastewater through regular inspections and pumpouts. The watershed ethic also includes the responsibility for rehabilitating and upgrading septic systems as they grow older. This can entail a costly investment every few decades or so, but is critical since many existing septic systems are approaching the end of their designed lives. Rural and suburban landowners may have to accept the notion that they must also pay the operating and capital costs for advanced sewage treatment that city dwellers have done for decades.

#### Articulating a Watershed Ethic for the Suburban and Rural Landowner

Despite the enormous growth of the environmental movement and a generation of universal environmental education in our schools, we have not articulated a

watershed ethic that applies to the suburban and rural landowner. As watershed professionals, we have been quite clumsy and timid in defining what it takes to live properly within a watershed. We need to come to some agreement about what personal responsibilities might comprise a watershed ethic for our time. With this in mind, we offer the following tentative list to stimulate more discussion:

- Inspect septic systems annually, and pump them out regularly
- Apply no fertilizer or pesticides to lawns
- Minimize turf area and avoid growing lawns in regions where the climate cannot sustain them without supplemental irrigation
- Gradually replace lawns with native trees, shrubs and ground covers
- Cultivate lawns with the primary goal of absorbing the runoff from roofs
- Take responsibility for disposing of the wastes of pets and hobby livestock
- Choose vehicles with low emissions and inspect them regularly
- Choose, in where we live, to reduce the miles we travel and prevent sprawl
- Be sensible in water use, as the cumulative demand for water during dry weather dramatically affects the flow of urban streams and rivers
- Use a commercial car wash, or at least wash cars on lawns using phosphorus-free detergents
- Avoid using hoses or leaf-blowers near the street or storm drain
- Maintain any stormwater practices, buffers or conservation areas present in neighborhoods

These simple steps help to minimize our collective impact on the watershed, but represent only the first steps of a watershed ethic. We can and should play an active stewardship role by advocating better local watershed protection and working together to restore degraded streams, lakes and estuaries. Stewardship takes many forms, whether it is a stream walk, a vote,

citizen monitoring, storm-drain stenciling, tree planting or joining a local watershed organization.

Many elements of the watershed ethic run contrary to our current notions of suburban taste and social status, and may initially resist change. For example, it may be a few years before you hear, "Hey neighbor, I am really impressed by all the biodiversity you produced on your lawn," or, "The filthiness of your car really expresses your concern for the environment, Dad," or, "My, how well Rover is buffer-trained."

But it is also reasonably certain that our culture can learn to practice a much better watershed ethic than we do now, if we create a stronger watershed message and learn to deliver it more effectively. - TRS

#### References

- Advanced Marketing Research (AMR). 1997. *Stormwater Tracking Study*. City of Eugene, Oregon. unpublished marketing survey.
- Assing, J. 1994. *Survey of Public Attitudes — February and July, 1994*. Russian Hill Associates. Alameda County Urban Runoff Clean Water Program. San Francisco CA. 84 pp.
- Aveni, M. 1994. "Homeowner Survey Reveals Lawn Management Practices in Virginia." Technical Note 26. *Watershed Protection Techniques*. 1(2):85-86.
- Aveni, M. 1998. *Water-wise Gardener Program: Summary Report*. Unpublished data. Virginia Cooperative Extension. Prince William County, VA.
- Barth, C. 1995a. "Nutrients: From the Lawn to the Stream." *Watershed Protection Techniques*. 2(1):239-246.
- Big Honking Ideas, Inc (BHI). 1997. *Final Report: Spring, 1997 Regional Advertising Campaign*. Prepared for Bay Area Stormwater Management Agencies Association. Oakland, CA.

Table 7: Comparison of Three Surveys of Fluid Changing by Backyard Mechanics

Study	Oil Changing	Antifreeze Changing
Maryland <i>Smith, 1996</i>	93% report oil recycling 7% did not recycle	83% reported oil recycling 17% did not recycle
California <i>Pellegrin, 1998</i>	30% do it yourselfers 12 to 15% report improper disposal, most put it in trash, but about 3 to 5% put it in storm drain system	18% do it yourselfers, 43% report improper disposal: 23% let it run to street 6% dump into storm drain
California <i>Assing, 1994</i>	28% do it yourselfers 17% report improper disposal (most in trash)	not asked



- Center for Watershed Protection (CWP). 1999. "Diazinon Sources in Runoff from the San Francisco Bay Region." Technical Note 106. *Watershed Protection Techniques*. 3(1): 613-616.
- De Young, R. 1997. *Healthy Lawn and Garden Survey: Data Analysis Report*. Rouge River National Wet Weather Demonstration Project. Oakland County, MI. 40 pp.
- Dindorf, C. 1992. *Toxic and Hazardous Substances in Urban Runoff*. Hennepin Conservation District. Minnetonka, MN. 98 pp.
- Elgin, D. 1996. *Public Awareness Study: Summary Report*. The Water Quality Consortium. Seattle, WA. 24 pp.
- Hardwick, N. 1997. *Lake Sammamish Watershed Water Quality Survey*. King County Water and Land Resources Division, Seattle, WA. 122 pp.
- Home and Garden Information Center (HGIC). 1996. *Residential Fertilizer Use Survey*. University of Maryland Cooperative Extension. College Park, MD. Unpublished surveys.
- Knox, G., A. Fugate and G. Israel. 1995. *Environmental Landscape Management- Use of Practices by Florida Consumers*. University of Florida Cooperative Extension Service. Bulletin 307. Monticello, FL. 26 pp.
- Kroupa and Associates. 1995. *Westmorland Lawn Care Survey*. Milwaukee, Wisconsin. 12 pp.
- Kroll, J. and D. Murphy. 1994. *Residential Pesticide Survey*. Water Management Administration. Maryland Department of Environment. Baltimore, MD 60 pp.
- Lawn and Landscape Institute. 1999. *Importance of Lawn Care Industry*. Website.
- Leopold, Aldo. 1933. *Game Management*. Scribners and Sons. New York. 482 pp.
- Minnesota Center for Survey Research (MCSR). 1997. *Lawn Care Survey- Results and Technical Report*. Technical Report 97-9. University of Minnesota. Minneapolis, MN. 60 pp.
- Morris, W. and D. Traxler. 1996. *Dakota County Subwatersheds: Residential Survey on Lawn Care and Water Quality*. Dakota County, Minnesota, Decision Resources, Ltd.
- National Service Research (NSR). 1998. *Pesticide Usage and Impact Awareness Study: Executive Summary*. City of Fort Worth Water Department. Fort Worth Texas. 44 pp.
- Ohrel, R. 1995. "Dealing with Septic System Impacts." *Watershed Protection Techniques*. 2(1): 265-272.
- Pellegrin Research Group. 1998. *Stormwater/Urban Runoff Public Education Program*. Interim evaluation. Resident population. Los Angeles County Department of Public Works. 28 pp.
- Professional Lawn Care Association of America (PLCAA). 1999. *Profile of Lawn Care Industry*. Web site address: www.plcaa.org
- Roberts, E. and B. Roberts. 1989. *Lawn and Sports Turf Benefits*. The Lawn Institute. Pleasant Hill, TN. 31 pp.
- Scanlin, J. and A. Cooper. 1997. *Outdoor Use of Diazinon and Other Insecticides: Final Draft*. Alameda County Clean Water Program and Alameda County Flood Control and Water Conservation District. Oakland, CA. 20 pp.
- Schueler, T. 1995a. "Urban Pesticides: From the Lawn to the Stream." *Watershed Protection Techniques* 2(1): 247-253.
- Schueler, T. 1995b. "Nutrient Movement From the Lawn to the Stream." *Watershed Protection Techniques* 2(1): 239-246.
- Schueler, T. 1999. "Microbes in Urban Watersheds." *Watershed Protection Techniques*. 3(1): 551-600.
- Smith, J. 1996. "Public Survey Used to Estimate Pollutant Loads in Maryland." Technical Note 73. *Watershed Protection Techniques*. 2(2): 361-363.
- Swann, C. 1999. *A Survey of Residential Nutrient Behaviors in the Chesapeake Bay*. Widener-Burrows, Inc. Chesapeake Research Consortium. Center for Watershed Protection. Ellicott City, MD. 112 pp.
- Syferd, E. 1995. *Water Quality Consortium. Research Summary Report*. Seattle, WA.
- U.S. Department of Agriculture. 1992. *National Crop-land Statistical Summary*. Website.

# On Watershed Education

**W**hile it may be true that old dogs cannot learn new tricks, there are some hopeful signs that our society will adopt new behaviors to protect the local environment. Witness the universally high rates at which we recycle bottles and newspapers, compost, and dispose of household hazardous wastes in the proper places, compared to a few decades ago. Littering and motor oil dumping are now much less socially acceptable behaviors than they once were. These dramatic social shifts occurred because a compelling case was made that changes were good for the environment (and reasonably convenient and inexpensive to make), and communities heavily invested in environmental education.

As the previous article establishes, the public does not always practice a very good watershed ethic, and continues to engage in many behaviors that are directly linked to water quality problems. Watershed education is the primary tool for changing these behaviors. The basic premise of watershed education is that we must learn two things: that we live in a watershed, and how to properly live within it.

A handful of communities have attempted to craft education programs in recent years to influence our watershed behaviors. These initial efforts have gone by a confusing assortment of names, such as public outreach, source control, watershed awareness, pollution prevention, citizen involvement, and stewardship, but

they all have a common theme: educating residents on how to live within their watershed.

Many more communities will need to develop watershed education programs in the coming years to comply with pending EPA municipal stormwater National Pollutant Discharge Elimination System (NPDES) regulations. Indeed, half of the six minimum management measures prescribed under these regulations directly deal with watershed education: pollution prevention, public outreach and public involvement. Yet, many communities have no idea what kind of message to send, or in which medium to send it out.

This article reviews the prospects for changing our behaviors to better protect watersheds. We begin by outlining some of the daunting challenges that face educators seeking to influence deeply rooted public attitudes. Next, we profile research on the outreach techniques that appear most effective in influencing watershed behavior. Special emphasis is placed on media campaigns and intensive training programs. Lastly, recommendations are made to enhance the effectiveness of watershed education programs.

## Challenges in Watershed Education

Watershed managers face several daunting challenges when they attempt to influence watershed behaviors:

**Table 1: Provisional Estimates of Potential Residential Polluters in the United States**

Watershed Behavior	Prevalence in Overall Population	Estimates of Potential Residential Polluters
Over-Fertilizers	35%	38 million
Bad Dog Walkers	15 %	16 million
Chronic Car washers	25%	27 million
Septic Slackers	15%	16 million
Bad Mechanics	1 to 5%	3 million
Pesticide Sprayers	40%	43 million
Driveway Hosers	15%	16 million

*Note: Estimates are based on 1999 U.S. population of 270 million, 2.5 persons per household, and average behavior prevalence rates based on surveys in Understanding Watershed Behavior.*

*A Lot of Minds to Change*

The most pressing challenge is that there are simply a lot of minds to change. Some notion of the selling job at hand can be grasped from Table 1, which contains provisional but conservative estimates of potential residential "polluters" in the United States in various categories. It is clear that we are not just dealing with a few bad actors or scofflaws, but rather the deeply rooted attitudes that are held by millions of people. While most people profess to support the environment, only a fraction actually practice much of a watershed ethic in their homes and yards.

*Most Residents Are Only Dimly Aware of the Watershed Concept*

It stands to reason that if citizens are asked to practice a watershed ethic, they need to know what a watershed is. Surveys indicate, however, that the average citizen is unaware of the watershed concept in general, and does not fully understand the hydrologic connection between the yard, the street, the storm sewer and the stream. Resident surveys also continue to show limited or incomplete understanding of terms such as "watershed," "stormwater quality" or "runoff pollution." For example, a recent Roper survey found that only 41% of Americans had any idea of what the term "watershed" meant (NEETF, 1999). The same survey found that just 22% of Americans know that stormwater runoff is the most common source of pollution of streams, rivers, and oceans.

At the same time, most of us claim to be very environmentally aware. For example, a Chesapeake Bay survey reported that 69% of respondents professed to be very active or at least somewhat active in helping to reduce pollution in the environment (SRC, 1994).

*Resources Devoted to Watershed Education Are Inadequate*

In recent years, several communities have developed education programs to influence the watershed behaviors practiced by their residents. Most of these efforts, however, are run on a shoestring. For example, CWP recently surveyed 50 local programs that have tried to influence lawn care, septic cleaning and pet waste behaviors (Swann, 1999). These education programs are typically run by the cooperative extension services, local recycling or stormwater agencies, or urban soil and water conservation districts. Most are poorly staffed (0.1 to 0.5 staff years), relatively new (within last five years), and have tiny annual budgets (\$2,000 to \$25,000). Given these limited resources, most watershed education programs have no choice but to practice retail, rather than wholesale, outreach techniques. Consequently, most watershed educators rely heavily on low cost techniques such as brochures, posters, workshops, and demonstration projects to disseminate their message.

Table 2: Most Influential Methods of Getting Messages to Citizens in Eight Citizen Surveys

	This Survey	WA (Elgin, 1996)	OR (AMR, 1997)	CA (Assing, 1994)	CA (PRG, 1998)	MI (PSC, 1994)	WI (Simpson, 1994)	MN (Morris, 1996)
Most Influence ↑	TV	TV ad	Direct Mail	TV Ad	TV	TV	TV	Newspaper
	TV ad	TV	TV ad	Stencils	Newspaper	Newspaper	Newspaper	Direct Mail
	Newspaper	Newspaper	Newspaper	Billboard	Radio	Cable TV	Newsletter	TV
	Local paper	Radio Ad	Radio	Local paper	Magazine	Local paper	Brochure	Neighbors
Least Influence ↓	Video	Brochure	TV	Brochure	Neighbors	Newsletter	Site Visit	Ext Service
	Brochure	Radio news	Bill Insert	Radio Ad	School	Video	Video	Radio
	Local cable	Paper Ad	Newsletter	Bus Sign	Billboard	Meetings	Meeting	Meeting
	Meeting	Billboard	Local paper	Direct Mail	Brochure	Brochure	--	Local cable

**Figure 1: Comparison of Outreach Methods Preferred by Residents to Those Used by Watershed Educators**

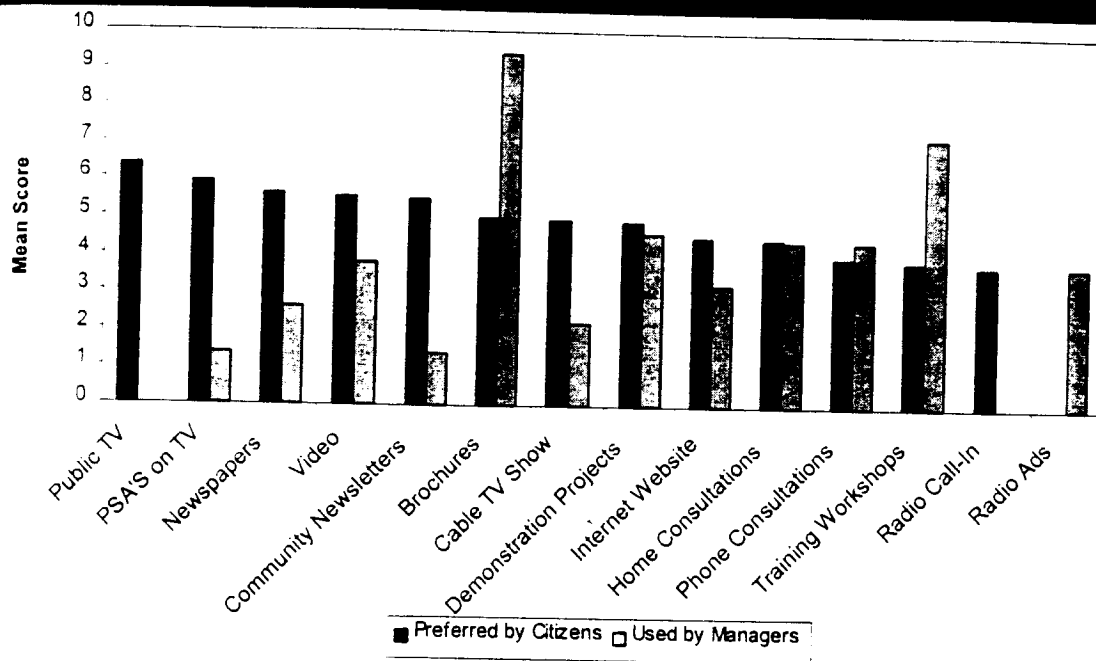

*The Marketing Techniques We Can Afford Don't Reach Many People*

Watershed managers need to send a clear and simple educational message that can attract the attention of the average citizen, who is bombarded by dozens of competing messages every day. A number of surveys have asked residents which outreach techniques are most influential in attracting their attention (Table 2). Messages sent through television, radio and local newspapers are consistently more influential in reaching residents than any other technique, with up to 30% recall rates by the watershed population for each medium. In contrast, messages transmitted through meetings, brochures, local cable and videos tend to be recalled by only a very small segment of the watershed population.

One clear implication is that watershed education efforts must utilize a mix of outreach techniques if they are going to get the message across to enough residents to make a difference in a watershed. Most existing watershed education programs, however, cannot afford to use the more sophisticated "wholesale" outreach techniques that are most effective at reaching the public with their watershed message. This gap is evident in Figure 1, which compares the outreach methods actually used by local watershed education programs with the outreach methods that residents prefer, based on responses from the Chesapeake Bay survey (Swann, 1999).

**Crafting Better Watershed Education Programs**

The first step in crafting better watershed education programs is to compile some baseline information on local awareness, behaviors and media preferences. The following are some of the key questions watershed managers should consider:

- Is the typical individual **aware** of water quality issues in the watershed they live in?
- Is the individual or household **behavior** directly linked to **water quality problems**?
- Is the behavior widely prevalent in the watershed **population**?
- Do specific **alternative(s)** to the **behavior** exist that might reduce pollution?
- What is the most clear and direct **message** about these alternatives?
- What **outreach** methods are most effective in getting the message out?
- How much **individual behavior change** can be expected from these outreach techniques?

The best way to elicit this information is to conduct a market survey within the watershed. If money is tight, a watershed manager can consult other resident surveys that are profiled in article 126.

The next critical step in crafting a watershed education program is to select the right outreach techniques. Several communities have recently undertaken

before and after surveys to measure how well the public responds to their watershed education programs. From this research, two outreach techniques have shown some promise in actually changing behavior: media campaigns and intensive training. *Media campaigns* typically use a mix of radio, TV, direct mail, and signs to broadcast a general watershed message to a large audience. *Intensive training* uses workshops, consultation and guidebooks to send a much more complex message about watershed behavior to a smaller and more interested audience. Intensive training requires a substantial time commitment from residents of a few hours or more.

Both media campaigns and intensive training can produce a 10 to 20% improvement in selected watershed behaviors among their respective target populations (Tables 3 and 4). Both outreach techniques are probably needed in most watersheds, as each complements the other. For example, media campaigns cost just a few cents per watershed resident reached, while intensive training can cost a few dollars for each resident that is actually influenced. Media campaigns are generally better at increasing watershed awareness and sending messages about negative watershed behaviors. Intensive training, on the other hand, is superior at changing individual practices in the lawn, home and garden.

Both techniques work best when they present a simple and direct watershed message, are repeated frequently, utilize multiple media and are directly connected to local water resources that are most important in the community.

Other important considerations for effectively marketing a watershed message are outlined below:

*Develop a stronger connection between the yard, the street, the storm and the stream.* Outreach techniques should continually stress the link between a particular watershed behavior and the undesirable water quality it helps to create (i.e., fish kills, beach closure, algae blooms). Several excellent visual ads that effectively portray this link are profiled in our watershed outreach award winners.

*Form regional media campaigns.* Since most outreach programs operate on small budgets, they should consider pooling their resources together to develop regional media campaigns utilizing the outreach techniques proven to reach and influence residents. In particular, regional campaigns allow communities to hire the professionals needed to create and deliver a strong message through the media. Also, the campaign approach allows a community to employ a combination of media, such as radio, television, and print, to reach a wider segment of the population. It is important to keep in mind that since no single outreach technique will be recalled by more than 30% of the population at large, several different outreach techniques will be needed for an effective media campaign.

*Use television wisely.* Television is the most influential medium for influencing the public, but careful choices need to be made regarding the form of television that is used. Our surveys found that community cable access channels are much less effective than commercial or public television channels. Program managers should consider using cable network channels targeted

Table 3: Effectiveness of Media Campaigns in Influencing Watershed Behaviors – Four Surveys

Location and Nature of Targeted Campaign	Effectiveness of Campaign
San Francisco Radio, TV and Buses BHI, 1997	Awareness increased 10-15% Homeowners who reduced lawn chemicals shifted from 2 to 5%
Los Angeles Radio and Newspapers PRG, 1998	Best recall: motor oil and litter (over 40%) Worst recall: fertilizer and dog droppings (<10%) Drop in car washing, oil changing, radiator draining of about 5 to 7% Greater self-reporting of polluting behaviors: dropping cigarette butts, littering, watering and letting water run on street, hosing off driveways into the street (10% or more)
Oregon Radio, TV AMR, 1997	19% reported a change in "behaviors"—changes included being more careful about what goes down drain, increasing recycling and composting, using more nature-friendly products etc.
Oakland County, MI Direct Mail PSC, 1994	44% of mail respondents recalled lawn care campaign 50% desired more information on lawn care and water quality 10% change in some lawn care practices as a result of campaign (grass recycling, fertilizer use, hand weeding). No change in other lawn care practices as a result of campaign

**Table 4: Effectiveness of Intensive Training in Changing Watershed Behaviors**

Location and Nature of Training Campaign	Effectiveness of Intensive Training
Maryland Direct Homeowner (Smith, 1996)	10% shift from self to commercial car washing. No change in fertilizer timing or rates. Better claims of product disposal.
Florida Master Gardener (Knox <i>et al.</i> , 1995)	No significant change in fertilization frequency after program. Some changes in lower rates, labels, slow release (8 to 15%). Major changes in reduced pesticide use (10 to 40%).
Virginia Master Gardener (Aveni, 1998)	30 to 50% increase in soil testing, fertilizer timing and aeration. 10% increase in grass clippings and 10% decrease in fertilizer rate.

for specific audiences, and develop thematic shows that capture interest of the home, garden and lawn crowd (i.e., shows along the lines of "This Old Watershed"). Well-produced public service announcements on commercial television are also a sensible investment.

*Understand the demographics of your watershed.* The middle-aged male should usually be the prime target for watershed education, as he is prone to engage in more potentially polluting watershed behaviors than other sectors of the population. Indeed, the most attractive audience for the watershed message is generally composed of men in the 35 to 55 year age group with higher incomes and education levels. Specialized outreach techniques can appeal to this group, such as radio ads on weekend sports events.

Another target group worth reaching includes what the Pellegrin Research Group (1998) terms the "rubbish rebels"— 18 to 25 year olds that tend to have low watershed awareness, engage in potentially polluting behaviors and are often employed in lawn care and other service industries. This age group is hard to reach using conventional techniques, but may respond to ads on alternative radio shows, concerts, and other events.

As America becomes more diverse, watershed managers should carefully track the unique demographics of their watersheds. For example, if many residents speak English as a second language, outreach materials should be produced in other languages. Similarly, watershed managers should consider more direct channels to send watershed messages to reach particular groups, such as church leaders, African-American newspapers, and Spanish-speaking television channels.

Watershed educators should also be careful about using the traditional environmental education model in which schools educate children who, in turn, educate their parents. Although environmental education in the schools was instrumental in achieving greater rates of recycling, it may not be as effective in changing watershed behaviors. While it is important to educate the next

generation of fertilizers, dog walkers, septic cleaners, and car washers, we need to directly influence the boomer generation now.

*Keep the watershed message simple and funny.* Watershed education should not be preachy, complex, or depressing. Indeed, the most effective outreach techniques combine a simple and direct message with a dash of humor. Some useful guidance on these techniques can be found in CSG, 1999.

*Make information packets small, slick and durable.* Watershed educators continually struggle with how to impart detailed information to residents on practicing the watershed ethic without losing their interest. The trick is to avoid the ponderous and boring watershed handbook that looks great to a bureaucrat but ends up lining a residential bird cage or litter box. One solution is to create small, colorful and durable packets that contain the key essentials about watershed behaviors and direct contact information to get better advice. These packets can be stuck on the refrigerator, the kitchen drawer or the workbench for handy reference when the impulse for better watershed behavior strikes. A particularly good example is provided in Figure 2.

*Educate private sector allies.* A wide number of private sector companies stand to potentially benefit from changes in watershed behavior. Better watershed behavior can drum up more sales for some companies, such as septic tank cleaners, commercial car washes, and quick oil change franchises, although these groups may need some help in crafting their watershed marketing pitch.

Clearly, the potential exists for lawn care companies and landscaping services to shift their customers toward more watershed-friendly practices. Nationally, lawn care companies are used by seven to 50% of consumers, depending on household income and lot size. Lawn care companies can exercise considerable authority over which practices are applied to the lawns

they tend, as long as they still produce a sharp looking lawn. For example, 94% of lawn care companies reported that they had authority to change practices, and that about 60% of their customers were "somewhat receptive to new ideas" according to a Florida study (Israel *et al.*, 1995). De Young (1997) also found that suburban Michigan residents expressed a high level of trust in their lawn care company.

Indeed, a small but rising proportion of lawn care companies feel that environmental advertising makes good business sense and can increase sales (Israel *et al.*, 1995). Clearly, intensive training and certification will be needed to ensure that watershed-friendly ads reflect good practice and not just slick salesmanship. It needs to be acknowledged that lawn care companies that are strongly committed to practices that reduce fertilizer and pesticide inputs need to be strongly endorsed by local government.

Right now, it is not likely that such companies are being chosen by the average consumer, who primarily relies on direct mail, word of mouth and cost when choosing a lawn care company (Swann, 1999 and AMR, 1997). For example, in the Chesapeake Bays survey, only 2% of residents indicated that they had chosen a lawn care company primarily on the basis that it was "environmentally friendly" (Swann, 1999).

Lawn and garden centers are another natural target for watershed education. Study after study indicates that product labels and store attendants are the primary

and almost exclusive source of lawn care information for the average consumer who takes care of his or her own lawn. At first glance, national retail chains should be strongly opposed to better watershed behavior, since it could sharply cut into lawn and garden product sales and the lucrative profits they produce (even at the expense of the community and environmentally friendly image they often market). The key strategy is to substitute watershed-friendly products for ones that are not, and to offer training for the store attendants at the point of sale on how to use such products.

#### Summary

Aldo Leopold summed up his opinion of what he termed "conservation education" in a 1942 essay entitled *Land Use and Democracy*:

*Conservation education, in facing up to its task, reminds me of my dog when he faces another dog too big for him. Instead of dealing with the dog, he deals with a tree bearing his trademark. Thus, he assuages his ego without exposing himself to danger.*

It can be said that our watershed education efforts are still in the "little dog" category. It is doubtful we can expect to protect or improve the quality of our urban watersheds until we shift our attention from the tree, and squarely confront the bigger dog. -TRS

Figure 2: An Example of Innovative Watershed Education Packaging

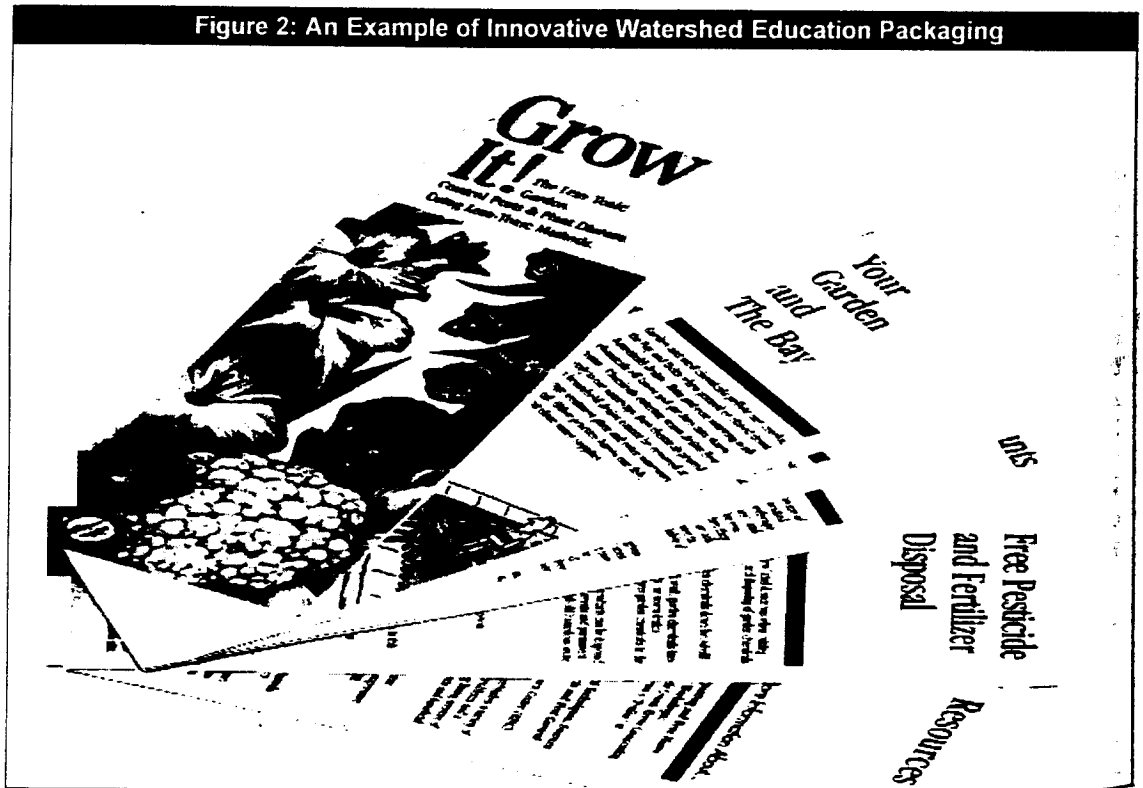

## References

- Advanced Marketing Research (AMR). 1997. *Stormwater Tracking Study*. City of Eugene, Oregon. Unpublished Marketing Survey.
- Assing, J. 1994. *Survey of Public Attitudes*. February and July, 1994. Russian Hill Associates. Alameda County Urban Runoff Clean Water Program. San Francisco Ca. 84 pp.
- Aveni, M. 1998. *Water-wise Gardener Program: Summary Report*. Unpublished Data. Virginia Cooperative Extension. Prince William County, VA.
- Basmaa (Bay Area Stormwater Management Agencies Association) and the San Francisco Water Pollution Prevention Program. 1997. *Grow It! The Less Toxic Garden*. Bay Area Stormwater Management Agencies Association, Oakland, CA.
- Big Honking Ideas, Inc (BHI). 1997. *Final Report: Spring Regional Advertising Campaign*. Prepared for Bay Area Stormwater Management Agencies Association. Oakland, CA.
- Council of State Governments. 1999. *Getting in Step: a Guide to Effective Outreach in Your Watershed*. Lexington, KY. 68 pp.
- De Young, R. 1997. *Healthy Lawn and Garden Survey: Data Analysis Report*. Rouge River National Wet Weather Demonstration Project. Oakland County, MI. 40 pp.
- Elgin, D. 1996. *Public Awareness Study: Summary Report*. The Water Quality Consortium. Seattle, WA. 24 pp.
- Israel, G., S. Pinheiro and G. Knox. 1995. *Environmental Landscape Management — Assessing Practices among Commercial Groups*. University of Florida. Cooperative Extension Service. Bulletin 307. Monticello, FL. 18 pp.
- Knox, G., A. Fugate and G. Israel. 1995. *Environmental Landscape Management — Use of Practices by Florida Consumers*. University of Florida Cooperative Extension Service. Bulletin 307. Monticello, FL. 26 pp.
- Leopold, A. 1942. "Land Use and Democracy." In: *the River of the Mother of God and Other Essays*. S. Flader and J. Callicott Editors. University of Wisconsin Press. Madison, WI. pp. 295-300.
- Morris, W. and D. Traxler. 1996. *Dakota County Subwatersheds: Residential Survey on Lawn Care and Water Quality*. Dakota County, Minnesota, Decision Resources, Ltd.
- National Environmental Education Training Foundation (NEETF). 1999. *National Report Card on Environmental Knowledge, Attitudes and Behaviors: Seventh Annual Roper Survey of Adult Americans*. National Environmental Education Training Foundation, Washington, D.C.
- Pellegrin Research Group (PRG). 1998. *Stormwater/urban Runoff Public Education Program: Interim Evaluation, Resident Population*. Los Angeles County Department of Public Works. 28 pp.
- Public Sector Consultants, Inc (PSC). 1994. *A Strategy for Public Involvement*. Rouge River National Wet Weather Demonstration Project. 56 pp.
- Simpson, J. 1994. "Milwaukee Survey Used to Design Pollution Prevention Program." Technical Note 37. *Watershed Protection Techniques*. 1(3):133-134.
- Smith, J. 1996. "Public Survey Used to Estimate Pollutant Loads in Maryland." Technical Note 73. *Watershed Protection Techniques*. 2(2): 361-363.
- Survey Research Center (SRC). 1994. *The Chesapeake Bay Attitudes Survey*. Communications Subcommittee. Chesapeake Bay Program. U.S. Environmental Protection Agency. 42 pp.
- Swann, Chris. 1999. *A Survey of Residential Nutrient Behaviors in the Chesapeake Bay*. Widener-burrows, Inc. Chesapeake Research Consortium. Center for Watershed Protection. Ellicott City, MD. 112 pp.



10

R0080086

# Advocacy

R0080087



# Choosing the Right Watershed Management Structure

Choosing the most effective watershed management structure to guide the development of the watershed and individual subwatershed plans is one of the more complex decisions a watershed manager confronts. Successful watershed planning requires a strong organization to focus the resources of a diverse group of stakeholders to implement the plan. A long-term management structure is not only critical to prepare and implement the plan in a rapid fashion, but also to revisit and update the plan as project goals are achieved or circumstances change.

Communities can create a single authority for an entire watershed or a series of smaller authorities at the subwatershed level. Whatever its size, a successful management structure should define inter-agency and governmental partnerships and agreements needed to support the organization over the long term.

Some of the typical functions of a watershed management organization are described in Table 1. As noted by Clements *et al.* (1996), a single champion agency or organization is often needed to build the watershed management structure, and coordinate and involve the many stakeholders needed for the plan.

However, not every management structure can or should incorporate all of the functions described in

Table 3. In the real world, where watersheds contain multiple jurisdictions, local governments lack certain management authority or funding is limited. The initial watershed management structure may take on a limited set of management functions.

Several different options are available to structure a watershed management organization. A watershed manager can choose between three broad models to organize the stakeholders for a management plan:

1. Government-Directed Model
2. Citizen-Directed Model
3. Hybrid Model

The primary difference among the three management options concerns the organization ultimately responsible for directing the watershed plan. In the government-directed model, local or regional agencies assume responsibility for making decisions about how the watershed is managed. Conversely, the citizen-directed model is driven by citizen activists or grass roots organizations. A hybrid organization combines the best of both models and is recommended for most watersheds. The basic elements of these models are presented in Table 2.

**Table 1: Functions of a Typical Watershed Management Structure**

**Acts as an umbrella organization:**

- Establishes links with existing groups and agencies.
- Coordinates watershed stewardship programs.
- Provides funding for watershed planning actions and explores funding options for plan implementation.
- Serves as a clearinghouse for watershed monitoring data and mapping.
- Reviews and prioritizes management strategies to achieve maximum watershed protection.
- Sets goals for the watershed as a whole and its component subwatersheds.
- Identifies gaps in monitoring data and takes steps to acquire the information.

**Operates as a forum for stakeholder input:**

- Encourages cooperative exchange of information.
- Provides an opportunity for early conflict resolution on contentious issues.
- Allows face-to-face discussion of management and implementation issues.

**Advocates for greater funding and support of the watershed.**

**Ensures long-term implementation of the plan:**

- Monitors progress of plan implementation.
- Review development projects for compliance with plan objectives.

Table 2: Typical Components of Watershed Management Structures

	Government-Directed Model	Citizen-Directed Model	Hybrid Model
<b>Formation</b>	Created by legislative authority.	Created at "grass-roots" level from citizens or other interested parties	Created with some governmental authority, with support from citizens.
<b>Membership</b>	Organization membership is appointed by governmental authority	Stakeholder participation is voluntary	Some members are required to participate, but many are volunteers.
<b>Authority</b>	Structure has regulatory authority over land use and other permits	Advisory capacity with no regulatory authority over land use or permits	Some members of the structure have regulatory authority, and others act in a volunteer or advisory capacity.
<b>Funding</b>	Funding is through taxes or levied fees	Funding is either by grant, donations, or sometimes by local government contributions	Much of the funding is through a steady source, such as an agreement with a local government, but grants may also comprise a significant portion of the budget
<b>Implementation</b>	Government agencies at the state, local and federal levels implement the plan.	Local governments implement the plan.	Local governments implement the plan, with some assistance from state and federal agencies.

*Model 1: Government-Directed*

Government plays an important role in any of the watershed management structure, but has the greatest role in the government-directed model. In this model, a state, federal or regional government leads the watershed planning effort. While citizens have an opportunity to influence the plan, their involvement is usually advisory or temporary. The government-directed model is most useful when citizens are not yet aware of watershed problems, or are not organized. The management structure may be created by basin management agencies or required by local, state, or even federal regulatory agencies. A government-directed plan has the advantages of a consistent funding source, and legal authority. There may be some concern, however, that a government-directed management structure can exclude important stakeholders, or that citizens will not develop any ownership in the plan. Government agencies need to make the effort to ensure that citizens have a meaningful opportunity to be involved early and frequently throughout the watershed planning process if this type of structure is to succeed. An

organizational chart for a government directed model is shown in Figure 1.

A *coalition of agencies* is often a loose collection of governmental agencies that realize that the only way to conduct a watershed plan is through a cooperative effort among the different jurisdictions and agencies within a watershed. This type of structure is frequently organized to address technical concerns dealing with a lack of monitoring data, inadequate coordination among various projects, or as a result of some concern over a particular resource. There are sometimes rivalries among the different agencies in this type of structure that can lead to less than enthusiastic support for the process. Citizen involvement can also be restricted if not specifically encouraged by the coalition.

*Model 2: Citizen-Directed*

In the citizen-directed model, citizen groups advocate for greater protection and drive the watershed planning process. As an outside force, they strive to engage local government to implement watershed plan

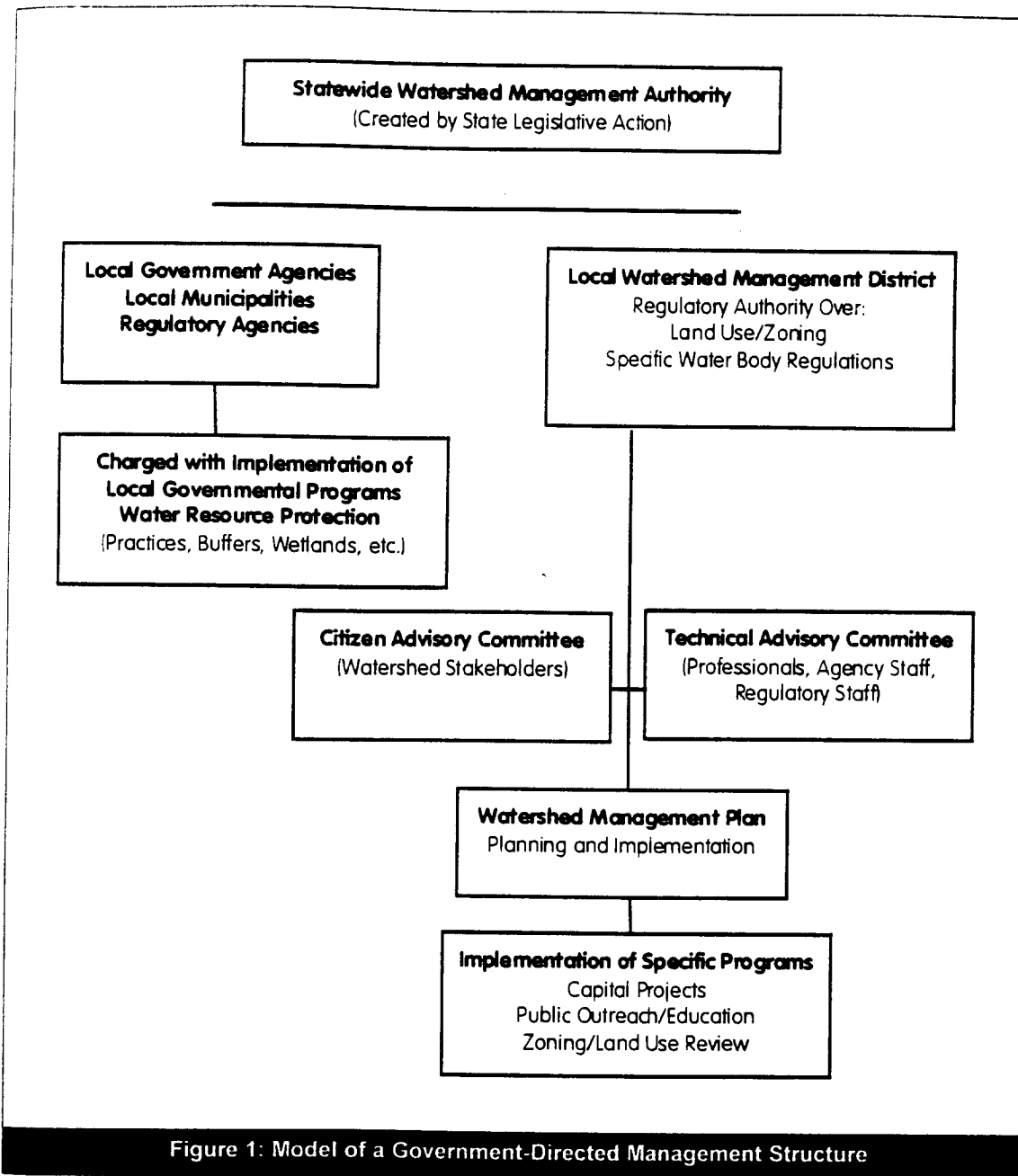

Figure 1: Model of a Government-Directed Management Structure

recommendations, but have little legal authority. This type of structure relies heavily on incorporating stakeholders at every phase. The plans produced by this type of management structure generally have strong support and ownership by the community. However, managers of citizen-directed efforts may run into difficulties securing stable funding. In addition, plan implementation can be difficult, since citizens can usually rely only on persuasion to enforce the plan. This model is most successful when it includes a strong cooperation with local government staff and elected leaders.

*Model 3: Hybrid*

A hybrid management structure combines the best elements of the government-directed and citizen-directed models. The hybrid model generally includes members from the local professional community, government agencies, citizens, and nonprofit organizations. The organization itself does not have regulatory authority, but makes recommendations to local governmental agencies to ensure that management strategies are implemented. Figure 2 illustrates the organizational structure of this type of institution.

The hybrid model seeks to incorporate as many stakeholders as possible in the watershed planning

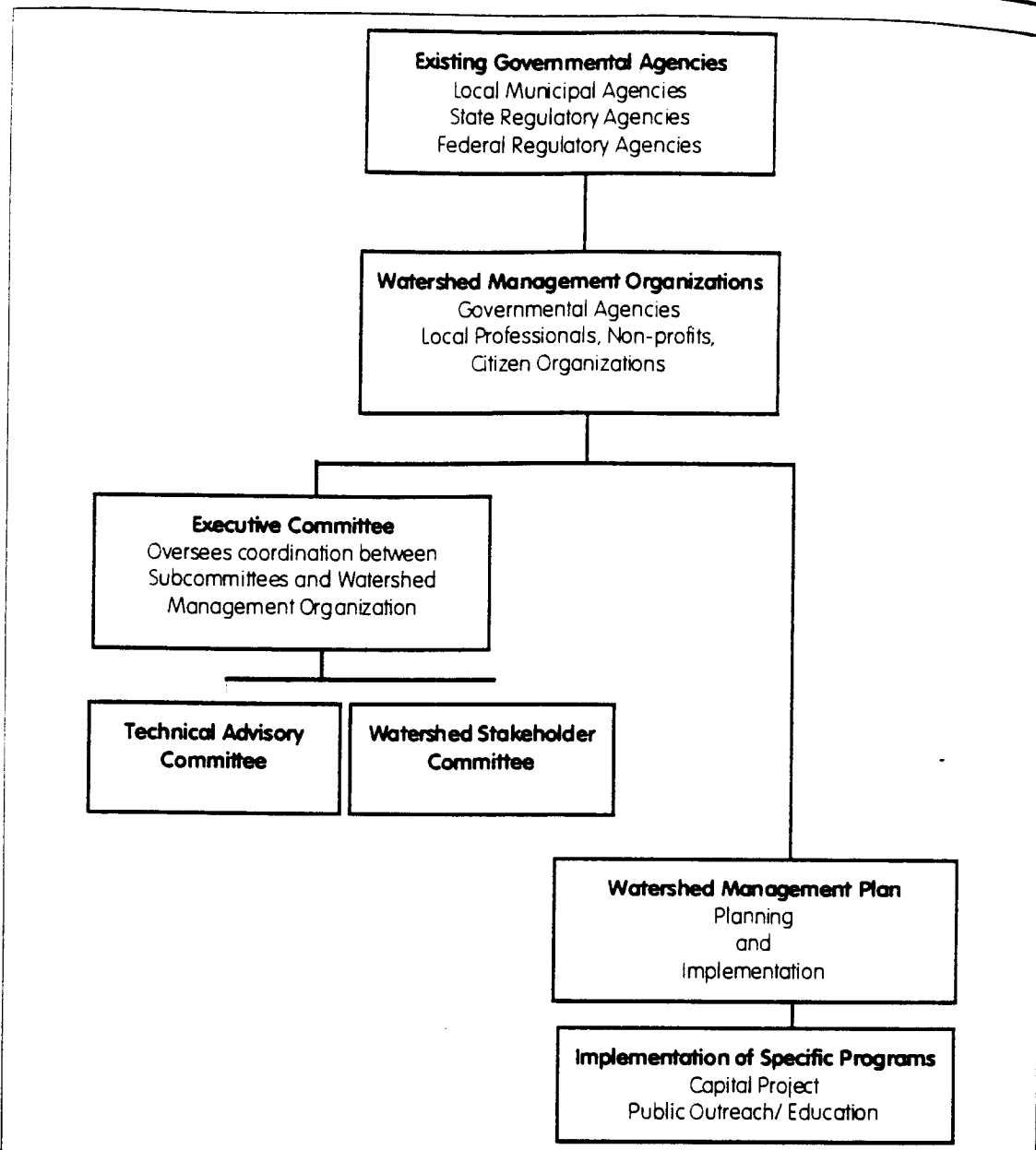

Figure 2: Model of a Hybrid Management Structure

process, either in an advisory or technical role. Technical committees are often set up to provide expertise on scientific issues, while citizen advisory committees afford the public a chance to voice their opinions in the management process. The hybrid model will often review development projects within a watershed and evaluate whether a particular project is compatible with the comprehensive vision of the watershed plan. A central principle behind the hybrid model structure is that greater watershed improvements can be achieved when there is proactive involvement of many watershed parties.

*Choosing the Most Appropriate Management Structure*

The advantages and disadvantages of each of the basic structures are presented in Table 3. While the government directed structure may be the most financially stable, the citizen-directed structure offers the most opportunity for local ownership of the plan. The political climate or community, as well as the problems that need to be solved, will influence the decision of what structure is most appropriate.

**Table 3: Choosing the Best Management Structure**

	<b>Advantages</b>	<b>Disadvantages</b>	<b>Where Best Applied</b>
<b>Government-Directed Model</b>	<ul style="list-style-type: none"> <li>• Has legal authority to influence development.</li> <li>• Has a secure funding source.</li> <li>• Consistent staff are available.</li> </ul>	<ul style="list-style-type: none"> <li>• May not incorporate all interests.</li> <li>• Citizens and local governments may not feel an ownership in the process.</li> </ul>	<ul style="list-style-type: none"> <li>• Where the plan will require extensive regulations and land use rules to implement.</li> <li>• Local community cannot raise the funds to develop and implement a plan.</li> <li>• Community is not strongly mobilized to take initiative.</li> </ul>
<b>Citizen-Directed Model</b>	<ul style="list-style-type: none"> <li>• Local community has ownership in the plan.</li> <li>• No stakeholders are forced to participate.</li> <li>• Residents are less intimidated by other citizens than the government.</li> </ul>	<ul style="list-style-type: none"> <li>• May be difficult to secure a stable funding source.</li> <li>• Implementation may be difficult without legal authority.</li> <li>• Since most members are volunteers, it may be difficult to complete the plan quickly.</li> <li>• The most vocal groups may be over-represented.</li> </ul>	<ul style="list-style-type: none"> <li>• The local community has a very strong interest in the water resource.</li> <li>• The local government has an excellent relationship with local citizens groups and developers.</li> <li>• Some external funding source, or a steady supply from local governments, can support the citizen group.</li> <li>• Disagreements between different interests is not anticipated to slow the group's progress.</li> </ul>
<b>Hybrid Model</b>	<ul style="list-style-type: none"> <li>• Has some authority to implement the plan.</li> <li>• Incorporates stakeholders from the public and the government.</li> <li>• Usually has some stable funding source, and permanent staff.</li> <li>• Technical expertise from many sectors can be used to formulate the plan.</li> </ul>	<ul style="list-style-type: none"> <li>• Demands significant input from citizens and government.</li> </ul>	<ul style="list-style-type: none"> <li>• Most watersheds.</li> </ul>

R0080093



### *Setting Up an Effective Management Structure*

It is crucial to choose a management structure that can be sustained over the life of the watershed planning process. A core set of features are needed to make watershed management structures effective:

- Adequate permanent staff to perform facilitation and administrative duties.
- A consistent, long-term funding source to ensure a sustainable organization.
- Inclusion of all stakeholders in planning efforts.
- A core group of individuals dedicated to the project who have the support of local governmental agencies.
- Local ownership of the watershed plan fostered throughout the process.
- A process for monitoring and evaluating implementation strategies.
- Open communication channels to increase cooperation between organization members.

The first two features, permanent staffing and long-term funding, are probably the most important. Clearly, having a permanent staff and adequate funding go hand in hand.

How long does it take to establish an effective management organization? The answer to this frequently-asked question depends on the level of stakeholder involvement. A reasonably small, highly motivated group of stakeholders with substantial agency support may establish a viable working organization within several months. As the number of stakeholders expands, however, more time must be spent on stakeholder identification and consensus building. A much longer time may be needed for a watershed organization to evolve into an effective team.

Another common feature of an effective watershed management structure is the reliance on a technical advisory committee (TAC) to support the overall watershed planning effort. A TAC is routinely made up of a public agency staff and independent experts who have expertise in scientific matters. The possible functions of a TAC include the following:

- Evaluate current and historic monitoring data and identify data gaps
- Coordinate agency monitoring efforts within the watershed to fill these gaps
- Interpret scientific data for the whole watershed management organization
- Assess and coordinate currently approved implementation projects

A citizen advisory committee (CAC) is also an important feature of an effective watershed management structure, particularly for a government-directed model. A typical CAC is open to broad citizen participation and

provides direct feedback to the management structure on public attitudes and awareness in the watershed. Meaningful involvement by a CAC is often critical to convince the community and elected leaders of the need for greater investment in watershed protection. Some of the possible functions of a CAC are as follows:

- Organize media relations and increase watershed awareness:
  - Press releases
  - Informational flyers
  - Watershed awareness campaigns
  - Liaison between citizen groups and government agencies
- Provide input on workable stewardship programs
- Coordinate programs to engage watershed volunteers, such as:
  - Stream monitoring
  - Stream clean-ups
  - Adopt-a-Stream programs
  - Tree planting days
  - Storm drain stenciling
- Explore funding sources to support greater citizen involvement

### *The Role of Government Coordination in Watershed Planning*

Governmental coordination is another essential ingredient of successful watershed structure, especially when the watershed extends over more than one political jurisdiction. Without the participation of a broad spectrum of local, state, and federal agencies, most watershed planning endeavors will lack the financial or technical resources to sustain themselves. In particular, participation by local agencies is very important, since these agencies have the primary authority to regulate land use. The challenge for the watershed manager is getting such a diverse group of agencies to commit to do more than just attending meetings. Skillful bureaucratic bargaining is needed to establish the trust for agencies to share resources and data, develop and endorse a plan, and become true partners over the long-term. One instrument to help promote better coordination is political agreements that legitimize the watershed management partnership. These political agreements are often known as memorandums of understanding.

These agreements define how government agencies and other stakeholders will work together to create or sustain the watershed planning effort. They are statements of intent between the numerous government agencies (i.e., land use regulation, habitat assess-

ment, etc.) and other interest groups that impact the watershed. They are not legally binding contracts, and are written in a general fashion in order to achieve a consensus. Partnership agreements such as these are typically short (one to two pages) and consist of a list of broad points outlining the goals and objectives for establishing the watershed management structure. The basic components of these agreements are as follows:

- List of parties and agencies formally in the plan
- Vision statement for the partnership
- Watershed issues to be addressed under the agreement
- Commitment to provide assistance and coordinate planning efforts through a central management structure
- Agreement to use the watershed plan to guide land use or water management decisions by each partner
- Details on funding sources, length of the agreement, and how new partners will be addressed
- Signatures of all partners involved

### Summary

Watershed organizations are among the fastest-growing groups of non-governmental organizations (NGOs) in the last decade. While there is no perfect recipe for the most effective kind of watershed management structure, one key ingredient is creative leaders who can both physically listen to other stakeholders and strenuously advocate what is right on behalf of the stream, creek, or river.

- TRS



# **Pollution Prevention At Home**

R0080097



# The Peculiarities of Perviousness

**M**uch has been made of the importance of imperviousness in determining the quality of aquatic systems in urban watersheds. Indeed, impervious cover is a very useful measure to predict current and future stream quality (Schueler, 1995). Still, pervious areas dominate much of the urban landscape, and their management should not be ignored or neglected. Many urban water managers feel that land that hasn't been paved must be providing some benefit to the watershed. While it is true that pervious areas are generally green, this does not always imply that they are environmentally benign. In fact, many pervious areas in the landscape are as intensively managed or cultivated as any cropland, as far as the input of water, fertilizer or pesticides are concerned.

In this article, the hydrology and pollutant dynamics of pervious areas are explored. To do so, it is necessary to examine the types and distribution of pervious cover found in urban landscapes. Next, the complex interactions of pervious and impervious cover are investigated, particularly along the many edges between the two. The next section examines the hydrological consequences of the direction of flow from

pervious areas to impervious ones, and vice versa. Finally, this paper looks closely at the pervious areas that receive high inputs of chemicals and water: lawns, golf courses, and public turf areas. The evidence that this high input turf, which comprises perhaps a third of all pervious areas, influences the water quality of urban streams is evaluated.

## The Many Natures of Perviousness

Pervious areas are very diverse in size and vegetative cover. Each community consists of a mosaic of forest, wetlands, meadow, lawn, turf, landscaping and the ubiquitous "vacant" lands. While the mix among these types varies based on the history and intensity of past development, pervious cover can be grouped into one of six general types (Figure 1). The estimated distribution of each type of pervious cover in a typical urban landscape is shown in Figure 2. It should be noted that these estimates are a composite drawn from many different sources and regions, and should be considered very provisional. More accurate local estimates of the distribution and management of pervious cover need to be developed.

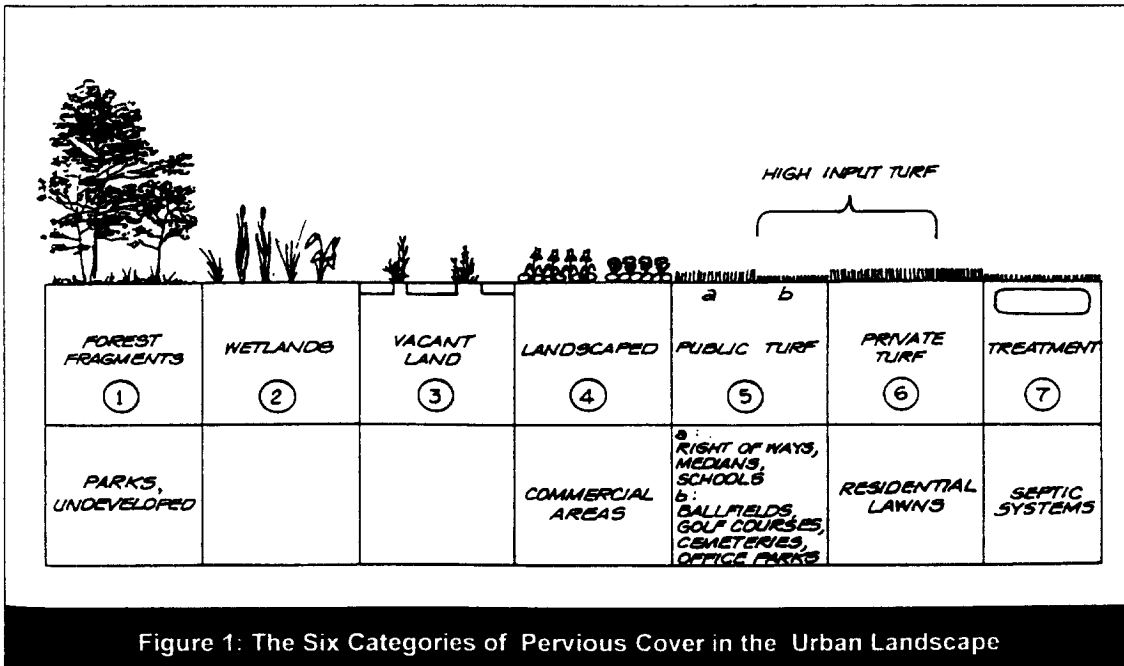
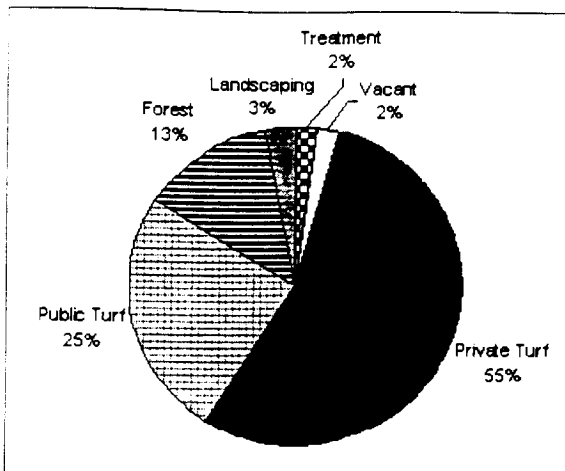

Figure 1: The Six Categories of Pervious Cover in the Urban Landscape



**Figure 2: Distribution of Urban Pervious Cover**

### 1. Forests and Wetlands

The extent of forests and wetlands in the urban landscape varies considerably from one region of the country to another, and even one city to another. After several decades of urbanization, however, much of the forest cover is restricted to public parks, stream buffers and the like. An example of the progressive loss of forest cover over time is seen in Sligo Creek, MD where the clearing of forests for new development has reduced forest cover to about 8% of watershed area over five decades, with the overwhelming majority now confined to the park system (MWCOC, 1991). The composition and diversity of the forest often changes remarkably due to urbanization, with a strong shift to non-native tree species and invasive shrubs and vines (Adams, 1994). As many as 30 to 60% of native forest species disappear from the highly urban forest community. Much of the forest cover in urban areas is often limited to isolated stands or individual street trees. While these small forest islands are important, they lack the structure, soils, and understory found in natural forests.

### 2. Private Turf (Lawns)

Our best estimate of the extent of home lawns is that they comprise about 70% of the total turf area in our urban landscape (Cockerham and Gibeault, 1985). Various authors estimate that lawns occupy a total area of some 25 to 30 million acres across the country (Roberts and Roberts, 1989). The lawn category can be further subdivided into high and low input lawns. High-input lawns are defined as those that are regularly fertilized, irrigated and receive applications of herbicides or insecticides. Homeowners apply chemicals to roughly two thirds of high-input lawns, while the remaining third is treated by lawn care companies. Low-input lawns are defined as those lawns that are regularly mowed, but seldom receive any chemical inputs. Surveys indicate

that the percentage of high- and low-input lawns are about equal in urban areas.

### 3. Public Turf

About 30% of the remaining turf in urban areas is devoted to "public turf," located within parks, golf course, schools, churches, cemeteries, median strips, utility corridors and office parks. The greatest share of public turf appears to be contained within parks, golf courses and school grounds (Cockerham and Gibeault, 1985). Management of public turf runs the gamut from regular mowing to very intensive turfgrass management (e.g, golf courses). Reliable estimates on the management status of public turf are hard to find, but it is thought that at least a third of it falls into the high input category.

### 4. Intensively Landscaped Areas

Commercial areas can comprise up to 20% of the urban landscape. Although commercial areas are highly impervious, many localities require that five to 10% of the site be intensively landscaped to provide visual relief, shade and create a more attractive environment. Much of this landscaping is in small fragments that are graded to run onto adjacent impervious areas.

### 5. Vacant Lands

Some portion of urban lands are always in transition from one use to another and remain vacant until that change occurs. In general, these vacant or open lands are temporary in nature and receive little in the way of vegetative management. They are frequently invaded by invasive or pioneer plant species. Depending on how long an area has been vacant, the cover can range from bare earth, weeds, meadow or shrubs. Erosion can be severe if vegetative cover is poor.

### 6. Treatment Areas

This last category includes lands devoted to treating urban stormwater runoff or septic system effluent. Collectively, these areas can constitute up to 3% of total area, and may be composed of open water (stormwater ponds and wetlands), grass (septic systems, filter strips and grass swales) or stone (infiltration trenches).

### Pervious but Not Natural

Nearly all of the pervious cover types have been highly disturbed and lack many of the qualities associated with similar pervious cover types situated in non-urban areas. Perhaps the greatest single change relates to the disturbance of native soils. Development usually involves wholesale grading of the site, removal of topsoil, severe erosion during construction, compaction by heavy equipment, and filling of depressions.

In recognition of this disturbance, most soil surveys change the native soil type to the ubiquitous moniker

"urban soils" after a site is developed. Urban soils tend to be highly compacted, poor in structure and low in permeability. As a result, urban areas often produce more runoff than before they were disturbed. For example, Pitt (1992) noted that one third of the disturbed urban soils he tested in Milwaukee had an infiltration rate of zero or near zero, exhibiting the same runoff response as concrete or asphalt.

Many pervious areas are also heavily influenced by stormwater that runs on from adjacent impervious areas, such as rooftops. These pervious areas actually receive an extra water subsidy, over and above the rainfall. Many pervious areas are also quite thirsty, and must be extensively irrigated during the drier summer months. Indeed, water demand for lawn irrigation often sharply increases municipal water use during the summer, and lawn watering restrictions are among the first restrictions to be taken extreme droughts.

### The Edge Effect: Fragments of Pervious Cover

When seen from the air, most impervious areas are small islands interspersed in a sea of pervious cover, ranging from a few hundred square feet to a few acres in size. The urban landscape is a complex mosaic of pervious and impervious cover that are linked and interlaced together. Since many impervious areas are linear in form (e.g., roads, sidewalks, and parking lots), extensive edges are created between the two types of cover. This "edge effect" is exemplified in the corner lot example portrayed in Figure 3, where nearly a thousand feet of edge are created in a little less than an acre. The many interactions between pervious and impervious cover have not been extensively investigated, but they are probably very important.

We tend to think of pervious and impervious areas as distinct and separate. Indeed, most hydrological models simulate the hydrological and water quality response of each area independently. Given the close proximity to each other, the assumption that the two areas do not interact is questionable. The greatest interaction probably occurs within a few feet of the "edge" between the cover types (Figure 3). Consider just a few pathways that a pollutant can travel across the edge—from a pervious to an impervious surface :

- Lawnmowers discharge lawn clippings (nutrients) from the yard to the street .
- Pollen (nutrients) blows from trees to the street in the spring.
- Leaves (organic carbon, nutrients) fall from trees and blow into the road or are stored along the curb to await municipal collection in the fall.
- Pesticides drift into the street during lawn care applications.
- Weed growth near the street is directly controlled by herbicides.

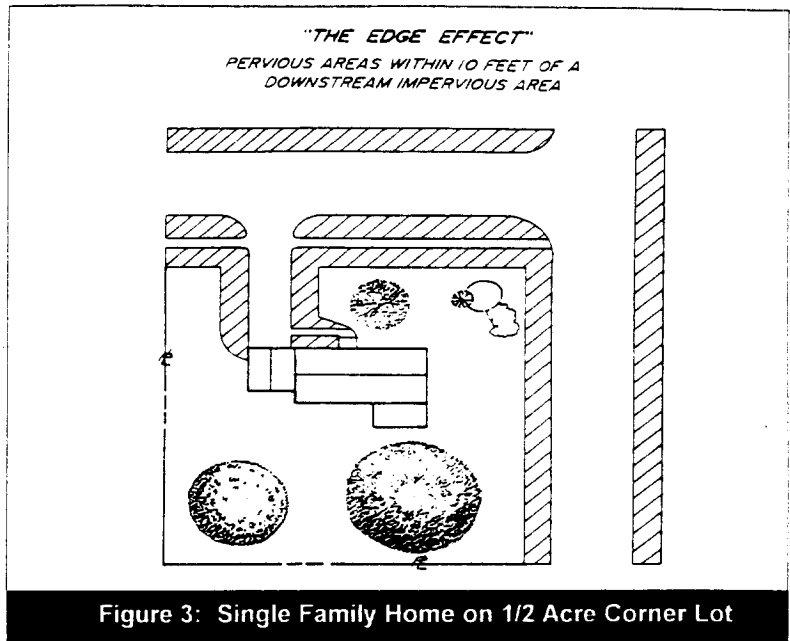

Figure 3: Single Family Home on 1/2 Acre Corner Lot

- Snow is plowed and stored along the edge, collecting pollutants (sediment, chloride, nutrients) throughout the winter and releasing them during the spring snowmelt.
- Pet owners are more likely to walk their pets along the edge, resulting in more pet droppings (bacteria, nutrients) along the edge.
- Significant erosion (sediments) can occur at the edge of the lawn and the street if this edge is not "protected" by curb and gutters.

Lastly, it is probable that a short zone close to the edge produces the bulk of the runoff from pervious areas, given the very short distance of overland flow. Any pesticides or fertilizers applied to this zone should have a greater potential to wash off during intense storm events. Clearly, more research needs to be done to examine how activities along this narrow edge influence the pollutant loadings generated by residential watersheds.

### Runon to and Runoff from Pervious Areas

From a hydrological perspective, pervious cover can be classified in terms of its relation to impervious cover, or more precisely, the direction of runoff from the pervious area (Figure 4). If the direction of flow is from pervious cover to impervious cover, then the stormwater will occur as *runoff*. On the other hand, if water flows from impervious cover to pervious cover, then the stormwater will occur as *runon*, and is much more likely to infiltrate into the soil. The practical implication is that if a site is graded to produce runon, it may be possible to significantly reduce the volume of stormwater runoff. Under some conditions, it may be possible to reduce stormwater pollutant loads, as well.



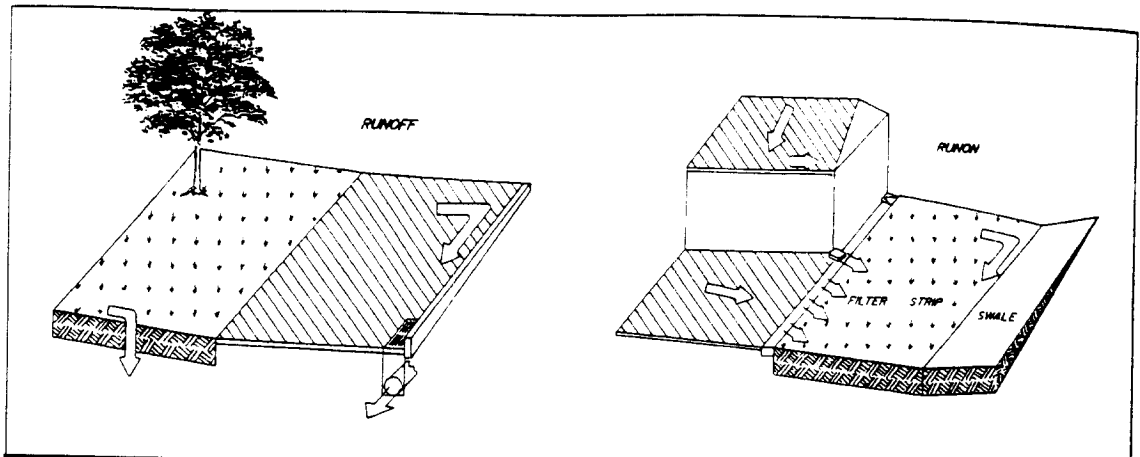

Figure 4: Directional Flow of Runoff and Runon

#### *The Benefits of Runon*

Not all impervious areas are connected to a storm drain network, and instead run onto pervious areas. Some examples are the following:

- Rooftop runoff that travels through downspouts and across grassed yards
- Road runoff that is directed into swales rather than curb and gutters
- Small parking lots that drain to forests or fields
- Isolated sidewalks and bike paths

The hydrologic effect of these disconnected impervious areas can be very significant, particularly in low-density residential watersheds. In some cases, disconnecting these impervious areas can create enough runon to reduce the "effective" impervious cover in a watershed by 20 to 50%. Roger Sutherland provides some useful equations for estimating the benefit of "runon" in reducing the effective impervious area in article 32.

Another way to increase runon is to send runoff from an impervious area to a stormwater practice in a pervious area. If the practice allows runoff to infiltrate or filter through vegetation, a portion of the runoff volume is effectively converted into runon. Some examples include filter strips, swales, biofilters, bioretention areas and infiltration trenches. Widespread installation of stormwater practices should have the effect of reducing the effective impervious area in residential watersheds, but this effect has never been measured.

#### *Runoff from Pervious Areas*

While every effort should be made to maximize runon to pervious areas, drainage considerations often dictate that most pervious areas will still be graded to drain to impervious areas or storm drains. Consequently, the hydrologic response of each of the six types of

pervious cover is of great interest. Most hydrologic research, however, has lumped all the types of pervious cover into a single category, or has assumed that pervious cover has the same properties as well-tended turfgrass. Thus, the majority of urban hydrology models utilize the Natural Resources Conservation Service (NRCS) curve number approach, where the runoff rate is dependent primarily on the soil type and to a lesser extent the vegetative cover at a site.

While these models have proven effective for predicting runoff volumes from pervious areas during large storm events (three to five inches or more), the curve number approach tends to grossly over-predict the runoff volumes produced during the smaller but more common events (Pitt, 1992). The small storm hydrology data presented by Pitt for two test watersheds (Figure 5) illustrate the increased runoff properties of urban lawns, presumably due to soil compaction. The volumetric runoff coefficients ( $R_v$ ) at these sites tended to progressively increase with rainfall depth, and typically were in the 0.10 to 0.23 range for soils in the "D" hydrologic soil group for moderate storm events. Lawns with more permeable soils (in the "B" soil group) produced less runoff volume ( $R_v$ 's ranging from 0.01 to 0.04 for small to moderate sized storms). Clearly, lawns may produce greater runoff volume than has been traditionally assumed. Even runoff testing of well-tended turfgrass has revealed that it still produces about half the runoff of bare soil during larger storms.

On the other hand, some pervious surfaces produce little or no runoff. For example, no runoff was recorded from meadow and mulch areas in simulated rainfall experiments conducted by Ross and Dillaha (1993), despite a total rainfall depth of 3.7 inches (Table 1). This finding suggests that creative and natural landscaping can strongly reduce stormwater runoff from yards.

In summary, we are just beginning to understand the hydrologic properties of urban pervious areas, and the evidence suggests that they behave quite differently

from pervious areas located in rural or agricultural landscapes.

### High-Input Turf

About a third of all pervious cover in the urban landscape can be considered as high-input turf, whether it is private lawn or public turf, according to our earlier provisional estimates. The inputs include water, fertilizer, and pesticides. The potential links between high-input turf and stream quality are reviewed below:

#### Irrigation

High input turf receives more water than is supplied by rainfall, due to extensive irrigation that sustains turf during dry periods in the summer. A typical lawn irrigation rate of an extra inch per week is frequently recommended in most regions of the country. Over the course of a dry summer, this can amount to perhaps a dozen inches of extra water. While much of the irrigation water is transpired by the grass or evaporates, studies have shown that the infiltration rate can double at excessive watering rates, resulting in additional water infiltrating into the soil. (Morton *et al.*, 1988). If the same lawn also receives runoff from adjacent rooftops or roads, it gets a second bonus of water. Given irrigation and runoff, it is probable that some high-input lawns may have greater recharge rates than would be expected from rainfall alone. It is further speculated that higher recharge rates from lawns may partially compensate for the lack of recharge from impervious areas, and may be a reason why some urban streams still maintain dry weather flows even when impervious cover is high.

#### Fertilization

Most surveys indicate that high input lawns are subject to heavy fertilization rates, although the exact rates vary with each individual yard and who actually conducts the fertilization. Reported nitrogen fertilization can average over 100 lbs/ac/yr when homeowners apply fertilizers to over 200 lbs/ac/yr when they are applied by commercial lawn care companies (Morton *et al.*, 1988). Although homeowners on average apply fertilizers at somewhat lower rates, they often apply them at the wrong time of year or too close to rain storms. The percentage of homeowners that actually take a soil test to determine if fertilization is actually needed is also quite low—usually no more than 10 to 20%.

The link between the high-input lawns and higher nutrient concentrations in the stream, however, has not been conclusively demonstrated at the watershed level. This may reflect the different routes each nutrient takes to the stream. Phosphorus, for example, is much more likely to reach a stream in surface runoff or attached to sediments. Researchers in Wisconsin have found that phosphorus concentrations in residential yards were higher than any other urban source area (Bannerman *et*

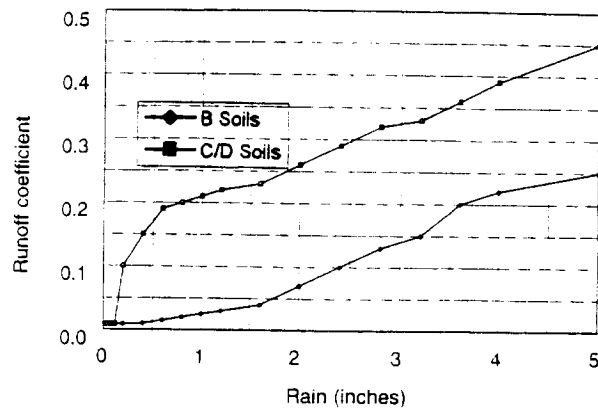

Figure 5: Runoff Coefficients for Lawns of Two Soil Types (Pitt, 1992)

*al.*, 1994). Since residential lawns produced only a fraction of the total runoff of impervious areas, however, they only generate about 20% of the total phosphorus load (despite the fact they comprised some 66% of total watershed area).

Many forms of fertilizer nitrogen take a different path to the stream, leaching into soil water and eventually migrating to the stream in groundwater. In particular, leaching of nitrogen fertilizers into the soil is enhanced when lawns are over-watered (see article 38). Consequently, stream monitoring should reveal higher concentrations of nitrate during dry weather periods. Various stormwater monitoring agencies have detected nitrate at the one to two ppm level in dry weather stream flow, but have been unable to directly link stream nitrate concentrations to prior lawn fertilization applications.

Fertilizers are but one of many nutrient inputs to the yard. Many homeowners are unaware that lawns receive an annual nitrogen and phosphorus subsidy via atmospheric deposition of 17 and 0.7 lbs/ac/yr, respectively (MWCOG, 1983). Other "free" sources of nutrients include the dilute concentrations of N and P present in municipal water used for irrigation, as well as nutrient concentrations in stormwater that may runoff from rooftops and roads.

#### Pest Control

The link between the application of lawn pesticides and impacts on urban streams is not entirely clear. There is no question that a great number and quantity of herbicides and insecticides are applied to urban lawns. There is also strong evidence that most pesticides remain on the lawn until they eventually degrade. At the same time, recent monitoring efforts are routinely detecting commonly used weedkillers and insecticides in urban streams, albeit at the low part per billion level. The

**Table 1: Comparative Runoff, Nutrient and Sediment Concentrations from Six Different Pervious Surfaces After 24 Hour Simulated Rain (Total 3.7 Inches) (Ross and Dillaha, 1993)**

Pervious Surface	Rv	Nitrate	Soluble P	TSS
Gravel Driveway	0.51	0.03	0.06	692
Bare Soils	0.33	0.32	0.79	1935
Cool Season Grass, Sodded	0.05	0.31	1.12	29
Warm Season turf	0.03	0.44	0.33	43
Mulched Landscape	0.00	None	None	None
Meadow	0.00	None	None	None

possible significance of these low pesticide concentrations on aquatic life are only just beginning to be studied. Several recent California studies strongly suggest that insecticide such as diazinon and chlorpyrifos pose a significant risk to aquatic health in residential watersheds (Connor, 1995). More research into the pathways and impacts of these highly toxic insecticides is needed to gauge the significance of the risk in other regions of the country.

**Peculiarity and the Public**

This article summarizes the limited research that has been conducted on the runoff and pollutant dynamics of pervious areas in urban watersheds. Clearly, the impact of our management of pervious areas on urban streams is not fully understood. Given this uncertainty, do we really have a strong enough foundation to justify the public outreach programs that encourage homeowners to reduce lawn inputs and change long-held behaviors? Watershed managers are actively promoting the presumed water quality benefits of alternative lawn care methods in nearly every region of the country. Will this outreach result in meaningful water quality improvements in our urban streams?

A full answer cannot be made until more research is performed. The evidence does generally suggest that chemicals applied to a relatively small fraction of the urban landscape (i.e., high input turf) do show up in urban streams, where they may exert some influence on the overall health of the aquatic ecosystem. It is also clear that management of pervious areas strongly influences the hydrology of urban watersheds. Indeed, many opportunities to protect streams through better understanding and management of our pervious areas have yet to be fully exploited.

-TRS

**References**

Adams, L. 1994. *Urban Wildlife Habitats-A Landscape Perspective*. University of Minnesota Press. Minneapolis, MN. 186 pp.

Bannerman, R. 1994. *Unpublished Data on Diazinon Concentrations and Toxicity in Stormwater Ponds*. Bureau of Water Management, WI Dept. Nat. Res., Madison WI

Claytor, R. and T. Schueler. 1996. *Design of Stormwater Filtering Systems*. Center for Watershed Protection. Chesapeake Bay Research Consortium. Silver Spring, MD 202 pp.

Cockerham, S and V. Gibeault. 1985. "The Size, Scope and Importance of the Turfgrass Industry." *Turfgrass Water Conservation*. Gibeault and Cockerham (eds). University of California. Riverside. Division of Agricultural and Natural Resources. pp. 7-12.

Connor, V. 1995. *Pesticide Toxicity in Stormwater Runoff*. Tech. Memorandum. CA Reg. Water Quality Bd., Central Valley Reg. Sacramento. Jan. 30.

Exner, M. M. Burbach, D. Watts. R. Shearman and R. Spalding. 1991. "Deep Nitrate Movement in the Unsaturated Zone of a Simulated Urban Lawn." *J. Environ. Quality*. 20: 658-662.

Metropolitan Washington Council of Governments. 1983. *Urban Runoff in the Washington Metropolitan Area: Final NURP Report*. Dep. Env. Programs, Washington. DC 222 pp.

Metropolitan Washington Council of Governments. 1991. *Forest Conservation Manual*. MD Dept. of Nat. Res. Annapolis, MD 202pp.

Morton, T., A. Gold and W. Sullivan. 1988. "Influence of Overwatering and Fertilization on Nitrogen Losses From Home Lawns." *J. Environ. Quality*. 17: 124-130.

Pitt, R. 1992. *Small Storm Hydrology*.

Roberts, E and B. Roberts. 1989. *Lawn and Sports Turf Benefits*. The Lawn Institute. Pleasant Hill, TN. 31 pp.

Ross, B and T. Dillaha. 1993. *Rainfall Simulation/Water Quality Monitoring for BMP Effectiveness Evaluation*. Final Report. Div. of Soil and Water Conservation. VA Dept. of Conservation and Historic Res. Richmond. 14 pp.

Schueler, T. 1995 "The Importance of Imperviousness." *Watershed Protection Techniques* 1(3): 100-111.

R0080104

## Toward a Low-Input Lawn

**W**hile many homeowners are concerned with stream quality, many also have a fundamental self-interest in retaining an attractive, dense and green lawn— regardless of the inputs of time, money, fertilizer, pesticides and water needed to sustain it. After all, a well-manicured lawn has undeniable aesthetic appeal to many residents. Therefore, one of the key challenges of any public outreach program is to convince roughly half of our homeowners that it is possible to grow a sharp looking lawn with low inputs (and not greatly increase the amount of labor expended to maintain it). This article sets forth some broad principles to guide homeowners toward a low-input lawn and provides a starting point for designing a more effective outreach program to achieve this goal.

The most important input to the low-input lawn is knowledge. Efficient management is based on a rudimentary understanding of soil properties, local climate, and the growing requirements of selected grass species. With this understanding of regional conditions, it is relatively simple to select appropriate grass species and to give the lawn what it needs at the proper time. Without this understanding, large amounts of grass seed, fertilizer, pesticides, water, and time may be wasted. This article presents the management techniques needed for a low-input lawn in eight key steps:

- Step 1. Lawn conversion
- Step 2. Soil building
- Step 3. Grass selection
- Step 4. Mowing and thatch management
- Step 5. Minimal fertilization
- Step 6. Weed control and tolerance
- Step 7. Integrated pest management
- Step 8. Sensible irrigation

These steps, summarized in Table 1, are intended to provide a framework for the homeowner interested in reducing lawn inputs. A continuum of management options is presented within each step, allowing the homeowner to make the transition to a low-input lawn by gradual stages. This article can also be used as a starting point for designing a better community outreach program to promote the low input lawn.

### Community Benefits of the Low-Input Lawn

Apart from their presumed benefit in reducing nutrient and pesticide runoff, low-input lawns provide other economic benefits to a community:

- Reduced summer water demand
- Preservation of landfill capacity
- Reduced cost for management of public lands

Some of these benefits have been quantified; others are a matter of common sense.

#### *Reduced Summer Water Demand*

Low-input lawns that use water conservation techniques can sharply reduce demands on water resources during periods of drought. During a recent California water shortage, it was estimated that 30 to 50% of all residential water use went to landscaping (Foster, 1994). Lawn watering was estimated to account for 60% of summer water use in Dallas, Texas (Jenkins, 1994). As a result, many Western municipalities now offer rate rebates to homeowners implementing water efficient landscaping (xeriscaping).

Changing watering techniques and replacing water-demanding plants with water-efficient and locally adapted ones can reduce water use by 20 to 43% (Foster, 1994). Even in humid Atlanta, Georgia, calculations showed that maintenance and water savings would pay for the cost of such retrofitting in only three years (Foster, 1994). Full conversion to xeriscaping (i.e., growing turf solely with the available rainfall supply) can easily cut water use by 50 to 60% (Foster, 1994; Ellesfon, 1992).

One of the first principles of xeriscaping is to reduce turf coverage on the lawn. As a general rule, grass consumes eight units of water, trees consume five units of water, and shrubs and ground covers consume four units of water (Foster, 1994). A one acre lawn consumes up to a half million gallons of water a summer in some regions of the country (Jenkins, 1994). A well-shaded lawn, however, uses up much less surface water on a hot, sunny day than an unshaded lawn (Foster, 1994).

#### *Preservation of Landfill Capacity*

Yard wastes (clippings, fallen leaves, trimmings, and uprooted weeds) can make up 20 to 25% of house-

Table 1: Eight Key Steps Toward a Low Input Lawn

<b>Step 1: Lawn conversion</b>	Convert lawn areas into groundcover, trees, shrubs, or meadow plantings. For a <i>low</i> input approach, replace the grass underneath mature trees with groundcover. For an even <i>lower</i> input approach, examine your lawn for potential conversion areas and plant groundcovers, trees, shrubs, or perennials in all areas where grass is hard to grow. For the <i>lowest</i> input approach, use turf only where it is the best plant to fulfill a particular function, such as providing a children's sports area.
<b>Step 2: Soil building</b>	Provide a strong foundation for the lawn. For a <i>low</i> input lawn, get a soil test to determine the soil's pH and fertility. You may not need to add any lime or fertilizer to your lawn. For a <i>lower</i> input lawn, test for soil compaction. Can you sink a screwdriver into the ground without pounding or is the soil compacted? If the soil is compacted, aerate with a hand corer or mechanical aerator. For the <i>lowest</i> input lawn, examine the soil's texture—neither extremely sandy soils nor extremely heavy clay soils make for good lawns. Next count earthworms—if none can be found in a square foot of soil, there's a problem. A healthy soil community has over 10 per square foot. With this basic understanding of soil acidity, fertility, compaction, texture, and earthworms, one can build soil that supports dense, healthy turf.
<b>Step 3: Grass selection</b>	Choose the type of grass that will be easiest to grow. For a <i>low</i> input lawn, select hardy grass species adapted to your region's climate. For a <i>lower</i> input lawn, select named grass varieties to meet your specific needs. For the <i>lowest</i> input lawn, try the new low-input slow-growing or dwarf grass mixes.
<b>Step 4: Mowing and thatch management</b>	Mow to the right height at the right time and recycle clippings. For a <i>low</i> input lawn, leave clippings on the lawn to provide nutrients and moisture. For a <i>lower</i> input lawn, set mowing height as high as possible. For the <i>lowest</i> input lawn, adjust mowing height and frequency during the growing season and monitor thatch levels.
<b>Step 5: Minimal fertilization</b>	Give the lawn what it needs but don't overfeed. For a <i>low</i> input lawn, recycle clippings and (in the right season) apply commercial fertilizer at half the recommended rate; avoid weed and feed formulations and don't fertilize if rain is imminent. For a <i>lower</i> input lawn, fertilize as above but use encapsulated nitrogen or an organic product instead—and fertilize only if soil tests show it's needed. For the <i>lowest</i> input lawn, substitute home generated compost for commercial organic or encapsulated products.
<b>Step 6: Weed control and tolerance</b>	Establish a realistic tolerance level for weeds and use least toxic control methods to maintain it. For a <i>low</i> input lawn use least toxic weed control methods such as: cultivation, solarization, flaming, mowing, or herbicidal soap. For a <i>lower</i> input lawn, grow strong healthy grass and it will crowd out weeds. For the <i>lowest</i> input lawn, broaden your definition of "lawn" to include weeds that perform desirable functions.
<b>Step 7: Integrated pest management</b>	Establish a realistic tolerance level for pests and use least toxic control methods to maintain it. For a <i>low</i> input lawn, use least toxic control methods such as removing or trapping pests, introducing biological control agents, or apply least toxic chemical controls such as insecticidal soaps. For a <i>lower</i> input lawn, grow strong, healthy grass that can resist attack. For the <i>lowest</i> input lawn, use cultural controls to prevent infestation, protect natural predators, and add beneficial soil microbes.
<b>Step 8: Sensible irrigation</b>	Practice water conserving landscaping techniques. For a <i>low</i> input lawn, water infrequently, in the early morning, but soak the lawn well. For a <i>lower</i> input lawn, water only when the lawn definitely needs it, and calibrate sprinklers. For the <i>lowest</i> input lawn, accept that the grass may not be green year round.

hold garbage (Kolb, 1991). A one acre lawn generates almost six tons of grass clippings a year, or nearly a thousand bags worth (Jenkins, 1994). It is estimated that yard waste fills up 10 to 50% of the nation's landfills (Jenkins, 1994). Although grass clippings decompose rapidly on the lawn, they often persist for a long time in landfills. In 1981 the city of Plano, Texas, instituted a program that encouraged residents to leave clippings on home lawns to provide nutrients and moisture. Knoop and Whitney (1989) reported the results: the city saved \$60,000 in disposal costs in the first year, even though the number of households served increased 12% over the same period. Residents participating in the program saved \$22,000 in plastic bag purchases. In 1989, it was estimated that Fort Worth, Texas could save about \$200,000 in annual disposal costs if all homeowners stopped bagging grass clippings. By 1991, 34 states had enacted restrictions on yard waste dumping or were debating such laws (EPA, 1991). In Seattle, an education program encouraged urban citizens to compost yard and food wastes. About 5,300 tons of yard waste were removed from disposal annually, for a net savings of \$378,000 (EPA, 1991).

#### *Reduced Cost for Management of Public Lands*

Integrated pest management (a pest control approach that minimizes pesticide use) is an excellent investment on public lands. Raup and Smith (1986) reported that integrated pest management (IPM) reduced community pest management costs by 22%, even though more pests were controlled under the new program. The use of expensive chemicals to control weeds can also be substantially reduced. Simply changing mowing height can, by itself, reduce weed levels by over 50% (Alliance for the Chesapeake Bay, 1994). Finally, converting lawns to plantings that require less intensive maintenance can also generate savings. In Maryland, a program to landscape highway interchanges allowed the state to reduce mowing by 10% for a \$300,000 savings (Rodbell, 1993).

#### Steps Toward the Low-Input Lawn

##### **Step 1: Lawn Conversion**

**Convert lawn areas into groundcover, trees, shrubs, or meadow plantings.** For a *low* input approach, replace the grass underneath mature trees with groundcover. For an even *lower* input approach, examine your lawn for potential conversion areas and plant groundcovers, trees, shrubs, or perennials in all areas where grass is hard to grow. For the *lowest* input approach, use turf only where it is the best plant to fulfill a particular function, such as providing a children's sports area.

##### *How Much Lawn Should Be Converted?*

Most lawns have areas that are not suited to grass growth. These include frost pockets, exposed areas,

dense shade, steep slopes, and wet, boggy areas. While it is possible to grow grass in any of these areas, higher inputs of fertilizer and/or water are needed to compensate for inhospitable conditions. In addition, these areas may be difficult to safely mow. Even in moderate terrain, lawns add up to large maintenance investments. The average homeowner spends 40 hours a year simply mowing, so a large lawn may take about as much time as the traditional family summer vacation (Schultz, 1989). Less lawn results in less work. The shape of an area should also be considered, since small, edge areas such as narrow strips or tight corners can be difficult to mow, water, and fertilize evenly. For lawns with the same surface area, water use rises as the perimeter increases (Ellefson, 1992). Converting lawn edges to less intensive plantings is a particularly effective strategy for reducing inputs.

Once a lawn area has been targeted for conversion, alternative plantings must be selected. Existing flowerbeds or groupings of trees and shrubs can simply be expanded, or groundcovers can be used to replace grass. Another option is to establish plantings that mimic native plant communities such as forests, meadows, and wetlands. In addition, some areas of the lawn can be converted into mulched beds.

##### **Step 2: Soil Building**

**Provide a strong foundation for the lawn.** For a *low*-input lawn, get a soil test to determine the soil's pH and fertility. You may not need to add any lime or fertilizer to your lawn. For a *lower*-input lawn, test for soil compaction. Can you sink a screwdriver into the ground without pounding, or is the soil compacted? If the soil is compacted, aerate with a hand corer or mechanical aerator. For the *lowest*-input lawn, examine the soil's texture: neither extremely sandy soils nor extremely heavy clay soils make for good lawns. Next, count earthworms: if none can be found in a square foot of soil, there's a problem. A healthy soil community has over 10 per square foot. With this basic understanding of soil acidity, fertility, compaction, texture, and earthworms, one can build soil that supports dense, healthy, turf.

The first step in building good soil is to take a soil test to determine pH and fertility. Soil should be tested every three years, with either an inexpensive test kit purchased at a garden center or a soil sample tested by the local Cooperative Extension Service (found in the Blue Pages). A soil test is essential to determine whether any fertilizer or lime is actually needed. The next step in soil building is to test for compaction.

Compaction keeps air, water and nutrients from entering the soil. Compacted soils have less microbial activity. Soil temperatures also increase, so grass in compacted soil may be one to 13 degrees hotter (Schultz, 1989). Grass grown in compacted soils also has shallower roots, more thatch, and is generally weaker. To

check for compaction, try to sink a screwdriver into the ground without pounding. If the screwdriver doesn't easily penetrate the soil, aerate with a hand corer or rent a mechanical aerator. Sometimes aeration is all that is needed to turn a problem lawn into a thriving lawn.

To complete the soil analysis, it is necessary to determine soil texture and count earthworms. Two simple methods are used to determine texture. In the first, a soil sample is mixed with water and the proportion of settled soil components (clay, sand, etc.) are measured. In the second, a handful of moist soil is collected and squeezed through the fist. Gershuny (1993) gives instructions for both tests. Neither extremely sandy soils nor extremely heavy clay soils make for good lawns, so it may be necessary to add organic matter.

Earthworms are only part of the critical soil life community, but they are a good indicator species. If none are found in a square foot of soil, this may indicate a problem with soil texture. A healthy soil community has over 10 worms per square foot (Gershuny, 1993). With this basic understanding of soil acidity, fertility, compaction, texture, and earthworms, one can build soil that supports dense and healthy turf.

### Step 3: Grass Selection

**Choose the type of grass that will be easiest to grow.** For a *low*-input lawn, select hardy grass species adapted to the region's climate. For a *lower*-input lawn, select named grass varieties to meet your specific needs. For the *lowest*-input lawn, try the new low-input slow-growing or dwarf grass mixes.

### Which Grass?

All grasses are not created equal. Most of us realize that bananas trees cannot be grown in the upper Midwest because they are not adapted to the winter climate or the short growing season. And yet, many homeowners try to grow bluegrass, which is best suited to the cool, rainy climate of England. Since bluegrass is a shallow-rooted and fast growing grass, it is prone to dry out very quickly in a hot or dry summer. It makes better sense to choose a more deeply-rooted grass (such as tall fescue) or one that is adapted to drier conditions (such as buffalograss). Grass selection also needs to reflect winter conditions. Warm season grasses such as zoysia go dormant (turn brown) in cold weather. They come out of dormancy when the weather is above 50 degrees, and grow best when the temperature is between 80 and 95 degrees. Cool season grasses such as fine fescues will stay green through the winter but go dormant in the summer. They grow best in 60 to 75 degree temperatures. The United States has been divided into six major grass growing zones, as shown in Figure 1. These zones help guide the selection of the grass species best adapted to the local climate (see Table 2).

Once a grass species has been selected, it is important to select the particular variety that suits the unique site conditions and maintenance requirements of the lawn. A wide range of cultivars (cultivated varieties) is now available. Cultivars have been developed for particular characteristics such as shade tolerance or improved disease resistance. Recent developments include slow-growing or even dwarf cultivars and grasses that require less fertilizer and water. Others have been developed with endophytes, fungi that enable the grass to resist surface-feeding insects including aphids, cutworms, chinch bugs and sod webworms. Cultivars are given names such as AURORA hard fescue or PRAIRIE buffalograss. A named cultivar also means that the seed or sod is certified to be true to type.

### Step 4: Mowing and Thatch Management

**Mow to the right height at the right time, and recycle clippings.** For a *low*-input lawn, leave clippings on the lawn to provide nutrients and moisture. For a *lower*-input lawn, set mowing height as high as possible. For the *lowest*-input lawn, adjust mowing height and frequency during the growing season and monitor thatch levels.

### Grasscycling: Letting Clippings Lie

Grass is unusual in that it does not grow from the tip but from the crown, near the soil line (see Figure 2). Mowing cuts off the oldest part of the plant, and thus the plant can tolerate repeated cropping. Traditional lawn care practices call for raking and removing clippings, which were thought to promote thatch and disease. In fact, leaving clippings on the lawn is benefi-

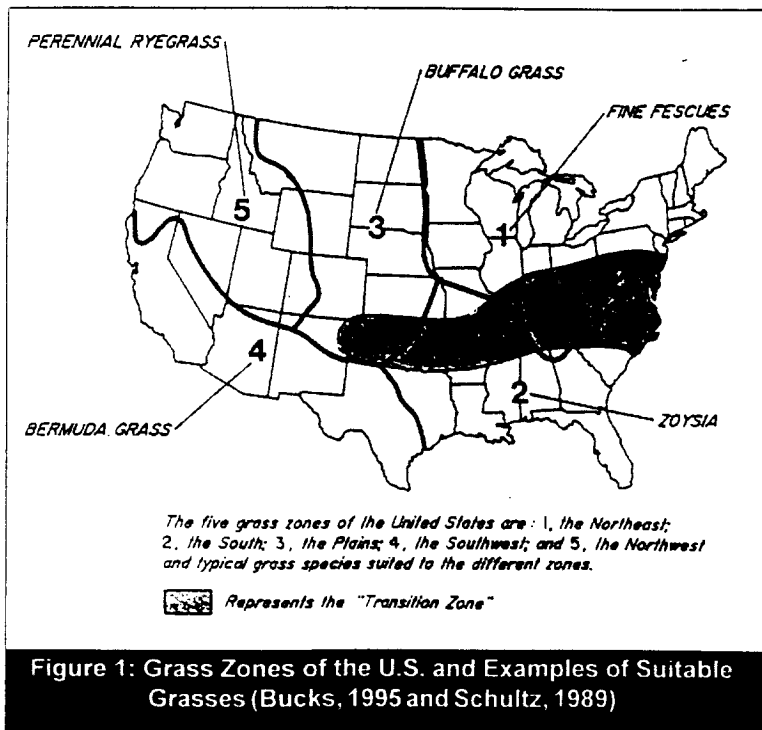

Figure 1: Grass Zones of the U.S. and Examples of Suitable Grasses (Bucks, 1995 and Schultz, 1989)

**Table 2: General Comparison of Grasses**

Type	Drought Tolerance	Disease Resistance	Insect Resistance	Heat Tolerance	Cold Tolerance	Growth Rate
<b>Cool Season Grasses</b>						
Kentucky bluegrass	medium	medium	medium	fair	excellent	medium
Perennial ryegrass	medium	fair	fair	fair	good	fast
Fine fescue	good	good	good	poor	excellent	slow
Tall fescue	good	good	excellent	medium	fair	fast*
<b>Warm Season Grasses</b>						
Zoysia-grass	excellent	good	good	excellent	medium	slow
Bermuda grass	excellent	fair	good	excellent	poor	fast
Centipede grass	poor	good	good	good	very poor	slow
St. Augustine grass	fair	medium	medium	good	very poor	fast
<b>Prairie Grass</b>						
Buffalo-grass	excellent	fair	good	good	good	slow

\* except for dwarf varieties which are medium to slow-growing

cial, so long as the lawn is frequently mowed. Clippings provide nutrients and moisture. Researchers at the University of Connecticut Agricultural Station used radioactive nitrogen to track the fate of applied nutrients when clippings are recycled. They found that within a week, most of the nitrogen from the clippings was incorporated into new grass growth. After three years, nearly 80% of the applied nitrogen had been returned to the lawn through the clippings (Schultz, 1989). The Rodale Institute Research Center found that an acre of clippings provides an average of 235 pounds of nitrogen and 77 pounds of phosphorus each year (Meyer, 1995). Clippings also return moisture to the grass, which helps protect against drought, and calcium, which helps keep the soil from getting too acid.

*How Low to Mow?*

Mowing height is critically important. Traditional lawn care looks to the close-cropped putting green as the ideal turf. Unfortunately, close mowing can weaken the grass and expose the grass crowns to sunburn. It also exposes the soil to sunlight, which may encourage weed seeds to germinate. Keeping grass taller will actually shade out weeds, reducing them by more than

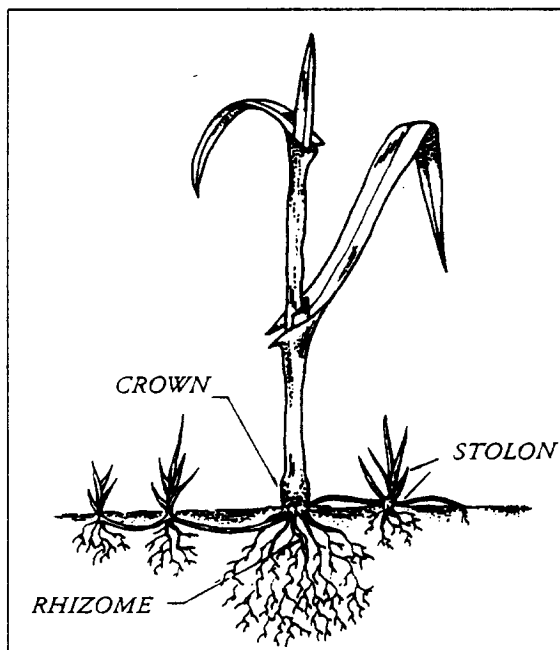

**Figure 2: Lower Anatomy of the Grass Plant (Schultz, 1989)**



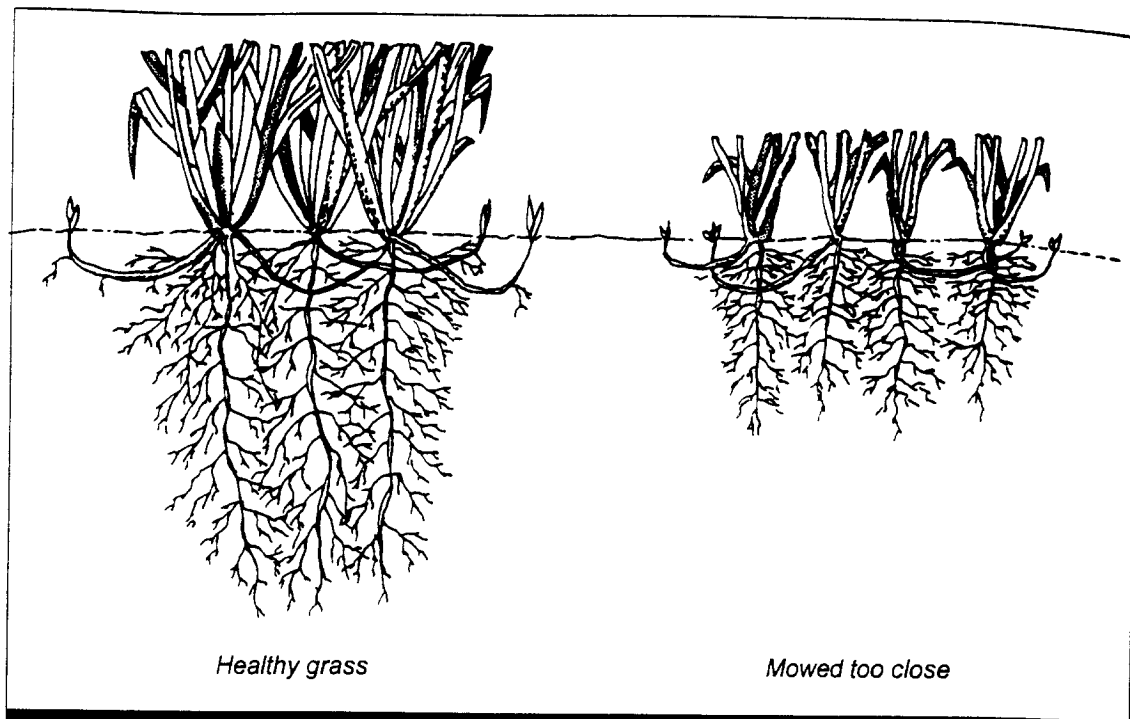

Figure 3: Mowing Height Affects Turf Density and Root Length (Ferrara, 1992)

50% (Alliance for the Chesapeake Bay, 1994). Mowing taller also encourages thicker turf and deep roots (Figure 3). Many grasses spread through stolons (shoots that run along the ground and produce a new plant at the tip) or rhizomes (underground horizontal stems that produce new plants).

Since the blade tips contain chemicals that inhibit side shoots, mowing can stimulate the growth of stolons or rhizomes. However, turf trials at Purdue University found the spread of grass varies with mowing height. After 22 weeks, a freshly-seeded lawn that was mowed to 3/4 inch height covered 42% of its plot. In contrast, a lawn mowed to three inches covered 80% of its plot (Schultz, 1989). Mowing high encourages deep roots because with more leaf surface, the grass plants are able to manufacture more food. Researchers at the Michigan Agricultural Station found closely cropped grass (one-inch mowing height) had less root growth and shoot regrowth, as well as fewer lateral stems (Schultz, 1989). Table 3 gives general mowing heights for different grass species.

#### *Mowing Frequency and Thatch Management*

Mowing frequency is also important. Mow too much or too often, and the grass can be damaged. To keep the grass healthy, it is recommended that no more than one-third of the leaf be cut at a time. While following the "one-third" rule may mean mowing more frequently, it does not necessarily mean spending more

time behind the mower. This is due to the fact that grass grows at different rates throughout the year. When the grass is growing rapidly, it may be necessary to mow twice a week. At other times, mowing twice a month may be sufficient.

Lastly, homeowners should learn how to recognize and measure thatch; too much thatch (over half an inch) is a sign of unhealthy grass, poor maintenance, and/or compacted soil. Thatch is a brown, straw-colored layer between the green grass and the soil. A small thatch layer is actually helpful, it functions like mulch in a flower-bed to conserve moisture and block weeds. When thatch is deep it may keep water, air and nutrients from reaching the grass roots. Shallow watering, overfertilization and close mowing all can increase the thatch layer. Practicing low input lawn care and aerating the soil can prevent excessive thatch build-up. If thatch build-up has occurred and sprinkle compost over the lawn (a practice called top dressing) and aerate to encourage thatch decomposition.

#### **Step 5: Minimal Fertilization**

**Give the lawn what it needs but don't overfeed.** For a low-input lawn, recycle clippings and (in the right season) apply commercial fertilizer at half the recommended rate; avoid weed and feed formulations and don't fertilize if rain is imminent. For a lower-input lawn, fertilize as above but use encapsulated nitrogen or an organic product instead—and fertilize only if soil tests

show it's needed. For the *lowest*-input lawn, substitute home generated compost for commercial organic or encapsulated products.

*How Much to Apply?*

The Lawn Care Field Guide lists regional resources that provide recommended fertilization rates for specific grass species. The actual amount required by a particular lawn may, however, be much less than the standard recommended rate. According to the Northern Virginia Soil and Water Conservation District a good rule of thumb is to use half of what you think you need or half of the manufacturer's recommended application, and never more than 44 lbs./acre in a single application. This advice recognizes that grasscycling can easily provide about half the required nutrients to the lawn. It also recognizes that it is better to underapply (since additional fertilizer can always be applied in the future) than to overapply and risk damage to the grass and runoff or leaching of excess nutrients. The surest way to apply the right amount is to get a soil test, and then fertilize only when the test indicates nitrogen is needed.

*When to Apply?*

Table 4 indicates the appropriate season for fertilization by region and grass type. Cool season grasses are best fertilized in the fall, when their roots are actively growing and topgrowth has ceased. Warm season grasses are best fertilized in several small doses during the summer. (Summer grasses maintain root growth during warm weather.) Fertilizing in the wrong season wastes money as much of that fertilizer goes unused (and increases the risk of stream pollution). Moreover, fertilization in the wrong season can either stimulate the growth of weeds or grass growth at the wrong time. For example, spring fertilization of cool season grasses usually gives broadleaf weeds a headstart in competing with grass, while summer fertilization may weaken the grass and increase water needs.

*What to Apply?*

It is best to use an encapsulated formulation or an organic fertilizer rather than inorganic forms to minimize nutrient leaching. Encapsulated fertilizers are coated to release nutrients more gradually. In leaching column tests, Alva (1992) found that losses of all three major nutrients (nitrogen, phosphorus, and potassium) were strongly reduced with controlled-release fertilizer blends. Lawn formulations with encapsulated nitrogen are often labeled "WIN" for water insoluble nitrogen.

Organic fertilizers are also a good choice, as they break down more slowly than traditional chemical fertilizers. In addition, composted organic fertilizers contain active microorganisms and humus. Humus not only helps build soil texture, but its complex organic compounds can buffer soil. The Connecticut Agricultural

Experiment Station in New Haven has been comparing vegetable plots treated with compost against plots treated with inorganic fertilizer. Results from the first 12 years show that compost-only treatment had similar yields and increased organic matter and water retention (Long, 1994). Italy's Soil Microbiology Center found that composting could sharply increase desirable soil microorganisms (Long, 1995a).

Disease symptoms may also be lessened with organic fertilizers. For example, researchers at Michigan State University found that bluegrass lawns treated with organic fertilizers suffered less disease than lawns treated with chemical fertilizers (Long, 1995b).

**Step 6: Weed Control and Tolerance**

**Establish a realistic tolerance level for weeds and use least toxic control methods to maintain it.** For a *low*-input lawn use least toxic weed control methods such as cultivation, solarization, flaming, mowing, or herbicidal soap. For a *lower*-input lawn, grow strong healthy grass and it will crowd out weeds. For the *lowest*-input lawn, broaden your definition of "lawn" to include weeds that perform desirable functions.

*What Is a Weed?*

"Weeds" go in and out of fashion. For example, clover was for many years an ingredient of premium

**Table 3: General Mowing Heights (in Inches)**

Species	Cool weather and/or shade	Hot weather	Last mow
Kentucky bluegrass	2.5	3.0	2.0
Perennial ryegrass	1.5	2.5	1.0
Fine fescue	1.5	2.5	1.0
Buffalo-grass	1.5	2.5	1.0
Tall fescue	2.5	4.0	2.0
Zoysia-grass	0.5	1.0	0.5
Bermuda grass	0.5	1.0	0.5
Centipede grass	1.0	2.0	1.0
St. Augustine grass	2.0	3.0	1.5

Table 4: General Regional Maintenance Calendar

Region	January–March	April–May	June	July–August	September	October–December
Humid Midwest and Northeast	Remove dead material and winter debris	Start new lawns, reseed or resod	Northern grasses may start to go dormant	Do not water in July; it promotes grub growth and the spread of disease	If needed, fertilize after active top-growth has stopped; apply lime. Start new lawns, reseed or resod.	Clean up and rake up
Humid South	Resod, respig, or replug; if needed apply lime	Start new lawns	If needed, partial fertilizer dose	If needed, partial fertilizer dose	If needed, fertilize winter grasses	Mow the first fall of leaves into the lawn
Plains	Remove dead material and winter debris	Mow often, but set blades high	Northern grasses may start to go dormant	Do not water in July; it promotes grub growth and the spread of disease	If needed, fertilize	Lower mower height to 2 inches for the last cut of the year
Southwest	Plant new lawns	If needed, partial fertilizer dose for summer species	This is the last month lawns should be planted	If needed, partial fertilizer dose for summer species	Mow high to shade out crabgrass	If needed, fertilize winter grasses
Northwest	Remove dead material and winter debris	Remove excess thatch	Monitor weed and grub levels	The grass will slow down, so mow less often	Start new lawns, reseed or resod	If needed, fertilize

lawn seed mixtures. However, once a herbicide was available to kill clover, it was no longer desirable. Indeed, many of the weeds that are decried in lawn care guides were once the mainstays of the kitchen garden. Everyone has to decide for themselves which weeds they can live with, and which must be controlled. The traditional lawn care approach of preventive pre-emergent weed control, however, is certainly wasteful and expensive, and may well contribute to the herbicide levels found in urban streams.

*How Many Weeds Make Too Many?*

Personal preference will dictate how many weeds should be tolerated. A lawn that is 10% weeds may appear to be weed-free, and even a lawn with 20% weeds can provide an attractive, consistently green appearance. To get an objective measure of how weedy a lawn is, a simple transect count can be performed. This is done by stretching a hose or string diagonally across the lawn. While walking along the line, look at the plants

in front of your toes. For each step, record weed or grass. Repeat the process on the other diagonal (forming an X) and then add up how many grasses versus weeds were found. The test can be repeated at regular intervals to monitor the effectiveness of weed control efforts. Whatever the selected tolerance level, it should be realistic. For example, zero weed tolerance is probably unattainable in the long run.

*What Good Are Weeds?*

Weeds can tell a lot about soil conditions. For example, sedges indicate poorly drained soil. Wild mustards are a sign of compacted soil or soil with a hard crust. Field peppergrass appears in alkaline soils. Daisies show poor fertility, while lamb's quarter could indicate the opposite. If clover is common in your lawn (and you didn't plant it), it indicates that nitrogen levels may be low. Since the clover fixes nitrogen, it can do well in areas where the grass may go hungry. Dandelions are especially common in lawns with acid surface soil.

Composting weeds that have been removed by hand can take advantage of desirable weed qualities. Most weeds help feed the compost pile, but plants like dandelions provide a special service. Called dynamic accumulators, they reach deep into the soil for essential elements. Traditional lawncare often recommends a feeding of iron to green up the lawn (not surprising since excess phosphorus can lead to iron deficiency). Instead, common weeds such as dandelion, chickweed, plantain, purslane, and lamb's quarter can be used for iron accumulation.

Many weeds also attract beneficial insects if allowed to flower. These insects need pollen or nectar in addition to the protein they get from consuming pests. For example, ladybugs feed on dandelion pollen and clover. In early spring, when not much is blooming, dandelions can be a very important food source for overwintering ladybugs. Predatory wasps take advantage of chickweed, while mustard attracts a variety of beneficial insects. Thus, weeds in the lawn can actually help plants in surrounding vegetable and flower beds.

Of course, insects aren't the only ones that find weeds appetizing. Some of the most common weeds are uncommonly nutritious for people. Before imported greens were available year-round, these plants served an important dietary function.

#### *Least-Toxic Weed Control*

There are four techniques to least-toxic weed control: cultivation, solarization, mowing, and herbicidal soap. Cultivation means physically weeding, and then seeding. While it seems like a lot of work, there are many devices available to make weeding easier. In any case, no matter how weeds are removed, the resulting bare spots should always be leveled and re-seeded to prevent weeds from reoccurring. Solarization involves covering a weedy patch with black plastic for a few days to shade out the weeds while leaving the grass intact. If an area is completely infested, clear plastic can be used to "cook" the weeds (and their seeds in the ground) for several weeks. Grass can then be re-established in the resultant cleared patch. In addition to setting mowing heights to shade out growing weeds, mowing the tops of tall weeds will weaken the plants and cut down on seed formation. Herbicidal soaps can be used to spot-treat weeds, but keep in mind they are toxic to all plants they touch. Herbicidal soaps usually break down in 48 hours.

While all four least-toxic control techniques are preferable to blanket herbicide applications, weed prevention is an even better option. The best defense against weeds is vigorous, healthy grass. If the homeowner follows the eight steps outlines in this article, weeds will not normally be a problem.

Finally, a lawn can be more than a green carpet. It can include attractive flowers and living fertilizer factories.

It can supplement the vegetable harvest and encourage beneficial insects to take up residence. Such a lawn is both more interesting and more functional than the traditional grass monoculture lawn. Some call it a "wild lawn" or a "flowery meade." While it is indeed wilder than a traditional lawn, it is still low-growing and more formal in appearance than a meadow. In the wild lawn, many so-called weeds become part of the design.

#### **Step 7: Integrated Pest Management**

**Establish a realistic tolerance level for pests and use least toxic control methods to maintain it.** For a *low*-input lawn, use the least toxic control methods such as removing or trapping pests, introducing biological control agents, or apply less toxic chemical controls such as insecticidal soaps. For a *lower*-input lawn, grow strong, healthy grass that can resist attack. For the *lowest*-input lawn, use physical controls to prevent infestation, protect natural predators, and add beneficial soil microbes.

#### *What Is Integrated Pest Management?*

The best defense against pests is healthy, vigorous grass. Table 2 compares major grass types for insect-resistance. Cultivars specially developed for insect or disease resistance are also available. When more control is needed, Integrated Pest Management (IPM) can control pests with far fewer pesticides than traditional lawncare. The IPM approach consists of four steps that are taken before any pesticide is used:

1. **Accurate pest identification and monitoring.** To select the right control, it is necessary to know the "good" bugs from the "bad" ones, and learn their life-cycles. For example, if Japanese beetles appear in your lawn and you pay attention to their numbers, you can get an idea of the size of the grub population to come. Forewarned is forearmed.
2. **Evaluation of risk.** Unlike the "see and spray" approach, IPM establishes action thresholds. For example, if Japanese beetle grubs might be a problem in spring or fall, dig a one foot square plot (two to three inches deep) and simply count the grubs. If more than six to eight grubs per square foot are present, control may be needed.
3. **Physical/cultural controls.** For example, adult Japanese beetles can easily be handpicked and destroyed.
4. **Biological controls.** Encourage predators and parasites to take up residence. For example, cardinals eat Japanese beetles. If birds are attracted with a nesting site, water, and winter food, they will be ready for duty when the beetles come. Beneficial nematodes can be introduced to attack the grubs.

### *How Can Pest Damage Be Prevented?*

Most lawn diseases are caused by fungi, and they are most likely to occur under particular conditions of temperature and humidity. Thus, an important part of prevention is learning which diseases tend to occur during which seasons. Selecting resistant grasses, water management, fertility management, mowing/thatch management, and aeration are all important in disease prevention. For example, dull mower blades tend to tear the grass, and the resultant ragged cut allows disease organisms easy entry. Having a mixture of lawn grasses also increases disease resistance.

One method of both preventing and treating lawn diseases is to increase the numbers of beneficial soil microbes. These microbes, which out-compete the disease organisms, are found in aged compost piles and composted tree bark. They are also available in some commercial organic fertilizer products. Least toxic chemical treatments include plant-derived products like neem oil or garlic oil as well as fungicidal soaps. For a thorough discussion of integrated pest management for lawn diseases and pests, consult a reference such as Olkowski, Daar, and Olkowski (1991).

### **Step 8: Sensible Irrigation**

#### **Practice water conserving landscaping techniques.**

For a *low*-input lawn, water infrequently, in the early morning, but soak the lawn well. For a *lower*-input lawn, water only when the lawn definitely needs it, and calibrate sprinklers. For the *lowest*-input lawn, accept that the grass may not be green year round.

Efficient lawn irrigation is not well understood by most homeowners. Often, the lawn is given a light watering whenever the weather is dry. This approach may do more harm than good, since the water never penetrates below the top few inches of soil. Such shallow frequent watering leads to shallow rooted, fragile grass. It is much better to water less, often but more deeply. Also, watering in the early morning avoids wasting water through evaporation.

At the other extreme, some homeowners install an automatic system and water whether the lawn needs it or not. This overwatering leads to excessive top growth, weakens the grass, requires frequent mowing, and sets the stage for disease to flourish. Overwatering also can leach away nitrogen even without overfertilization (article 132). Instead, the goal should be to water only when the lawn really needs it. If footprints can be seen after walking across the lawn, it may be a signal to water. Sprinklers should be carefully calibrated in inches of water per hour to determine the time required to wet the soil to a depth of six inches. In times of drought, it is necessary to make up the difference using a general rule of thumb of one inch of water every seven to 10 days (or water until it reaches a desired soil depth of six to 18 inches). Be sure not to apply water faster than the

ground can absorb it, or runoff may be created. Lastly, *water harvesting* techniques such as sloping walkways toward turf areas or extending downspouts into the ground can be used to promote runoff and make more efficient use of rainfall.

Finally, it should be kept in mind that it is not natural for lawns to stay green year-round in most parts of the country. Since grass grows from the crown instead of the tip, the plant lets the leaves go dormant in order to survive a drought. Though brown, crunchy, and to all appearances dead, the lawn will revive when cooler temperatures and wetter weather return. Drought should be regarded as a natural seasonal event, like trees losing leaves in the fall. Homeowners that resist the urge to water save on water bills and get a welcome break from mowing chores.

-CAB

### **References**

- Alliance for the Chesapeake Bay. 1994. *Conservation Landscaping: A Homeowner's Guide*. Alliance for the Chesapeake Bay. 6pp.
- Alliance for the Chesapeake Bay. *Environmentally-Sound Landscape Management for the Chesapeake Bay*. 7pp.
- Alva, A.K. 1992. "Differential Leaching of Nutrients From Soluble vs. Controlled Release Fertilizer." *Environ. Mgmt.* 16(6): 769-776.
- Bucks, C. 1995. "The Right Grass = a Great Lawn." *Organic Gardening*. 42:538-42
- EPA. 1991. "Seattle Tilth Teaches City-Dwellers to Compost." *Reusable News*. EPA Office of Solid Waste and Emergency Response. Fall 1991: 3-4
- Ellefson, C., T. Stephens, and D. Welsh. 1992. *Xeriscaping Gardening*. Macmillan. New York, New York 323 pp.
- Ferrara, M. 1992. "Plant a Low-Maintenance Lawn." *Organic Gardening* 39:246-50
- Foster, R.S. 1994. *Landscaping that Saves Energy and Dollars*. Globe Pequot Press. Old Saybrook, CT. 224 pp.
- Gershuny, G. 1993. *Start with the Soil*. Rodale Press, Emmaus, PA. 274 pp.
- Jenkins, V.S. 1994. *The Lawn—A History of an American Obsession*. Smithsonian Institution Press. Washington, DC 246 pp.
- Knoop W. and Whitney R. 1989. *Don't Bag It Lawn Care Plan*. Texas Agricultural Extension Service. Fort Worth, TX 52 pp.
- Kolb, J.A. 1991. *Puget Soundbook*. Marine Science Society of the Pacific Northwest. Port Townsend, WA. 47pp.
- Long, C. 1995a. "Compost Tea Confirmed!" *Organic Gardening*. July-August 1995: 16-17.

- Long, C. 1995b. "Small Ground." *Organic Gardening*. 42:321
- Long, C. 1994. "Compost Forever!" *Organic Gardening*. 41:7-18
- Mattern, V. 1994. "Don't Weed 'Em — Eat 'Em." *Organic Gardening*. April 1994: 70-74
- Meyer, S. 1995. "What Do You Feed a Hungry Lawn?" *Organic Gardening*. May-June 1995:46-48
- Olkowski, W., S. Daar, and H. Olkowski. 1991. *Common-Sense Pest Control*. Taunton Press. Taunton, CT. 715 pp.
- Raupp, M.J. and D.C. Smith. 1986. "Economic and Environmental Assessment of an Integrated Pest Management Program for Community-owned Landscape Plants." *J. Econ. Entomol.* 79: 162-165
- Rodbell, P.D. 1993. "Planting Partnerships Down the Road." *Urban Forests* April-May 1993: 18
- Schultz, W. 1989. *The Chemical-Free Lawn— The Newest Varieties and Techniques to Grow Lush, Hardy Grass*. Rodale Press. Emmaus, PA. 194 pp.
- Westbrook, W. 1994. "Grow the Right Grass for Your Region." *Organic Gardening*. 41:762-65

# Homeowner Survey Reveals Lawn Management Practices in Virginia

**W**atershed managers tend to make two assumptions about the link between lawn care and water quality. The first is that an army of envious suburban homeowners emerges each weekend to apply ever more massive doses of fertilizer and pesticides to create the perfect green sward. The second assumption is that this army would quickly surrender once they were informed about the water quality impacts of their excessive lawn care practices. So much the wiser, they would accurately calibrate lawn spreaders, test their soil prior to fertilization, practice integrated pest management, compost yard wastes, and recycle lawn clippings back on their yards.

As it turns out, recent surveys of suburban lawn care practices in Northern Virginia suggest that both assumptions are overly simplistic. Through an innovative residential water quality program, Marc Aveni and his colleagues at the Prince William Cooperative Extension have conducted detailed surveys of actual lawn care practices in Prince William County, Virginia. The county, situated to the southeast of Washington D.C., has experienced rapid suburban growth in the last 15 years. Aveni surveyed 100 homeowners on their lawn care practices, before and after they had enrolled in a demonstration residential lawn care program.

The pre-survey provides a revealing snapshot of current residential lawn care practices. For example, 79% of suburban lawns had been fertilized in the past year. Pesticides had also been applied to 66% of the lawns. Chemicals were typically applied by the homeowner, rather than lawn care companies (85% vs. 10% of all lawns). Some homeowners spent impressive sums of time and money on their yards: 35% spent in excess of \$100 on chemicals per year and labored on their lawns for more than four hours per week. A majority of homeowners (65%), however, spent less than \$100/year on lawn chemicals and worked three hours or less each week.

Less than 20% of residents tested their soil to determine whether their yard actually needed fertilization. Similarly, lawn owners were equally split as to the best season to apply fertilizer (spring and fall). Residents showed relatively little interest in non-chemical lawn care practices, such as turf aeration and dethatching: fewer than 30% of suburban lawns received such treatments. Nearly 50% of homeowners

watered their lawns on at least a weekly basis in the summer.

Homeowners consulted a wide range of information sources to guide their lawn care efforts. Their number one information source was product labels on the shelf, followed by newspapers and magazines, the advice of the hardware store or nursery clerks, and the wisdom of their friends and neighbors. Their least common information source, to Aveni's dismay, were unbiased lawn experts such as the Cooperative Extension Service.

While developing an outreach program to improve residential lawn care practices, Aveni quickly noted two important facts.

- Most residents were at least somewhat aware and concerned about the links between lawn care and water quality. However, most did not have much time to learn about better lawn care practices.
- While homeowners are often willing to adopt lawn practices that improve water quality, they still want a sharp-looking lawn.

With support from the Extension Service, U.S. Department of Agriculture, a practical public education program was instituted in Prince William County that utilized the concept of neighborhood demonstration lawns. The concept works as follows. Interested individuals are recruited from Extension-sponsored field days where water-quality oriented lawn care practices are demonstrated. Each recruit is given short but intensive training on how to implement the recommended lawn care practices.

Over the course of the next year, an expert "Master Gardener" volunteer visits the homeowner to provide more one-on-one training and collect a soil test. After a year of practice and demonstrated understanding of the recommended practices, the homeowner's lawn may be designated as a demonstration lawn, with an attractive sign to pique neighborhood curiosity.

Post-surveys indicated that homeowners significantly changed both their attitudes and actual lawn practices as a result of participating in the demonstration lawn program. Sharp increases in soil testing, fall fertilization, pest identification, grass composting, and yard aeration were recorded, as well as sharp decreases in pesticide applications. Participants generally reported

that the time and money they spent caring for their lawns stayed the same or declined. Most importantly, most homeowners in the program commented that the appearance of their lawn improved as a result of the program.

Aveni stresses the importance of understanding the sociology of nonpoint source pollution when advocating watershed education practices. Credible out-

reach programs must be based on a detailed knowledge of what homeowners actually do and why they do it. Watershed education programs also must go beyond simple brochures to more intensive hands on training if they are to be effective.

—TRS

#### References

Aveni, Marc. 1996. *The Water-wise Gardener: An Extension Agent's Guide to Planning and Delivering Residential Water Quality Programs*. Virginia Cooperative Extension. VA Tech, Blacksburg, VA.



## Nitrate Leaching Potential from Lawns and Turfgrass

**I**t is well documented that high rates of nitrogen fertilization of row crops, such as corn, soybeans and tobacco, can cause nitrate to leach into groundwater at concentrations in excess of 10 mg/l. Nitrate levels of this magnitude can contaminate drinking wells, and lead to nutrient enrichment problems in sensitive coastal waters.

Given that many lawns receive high applications of nitrogen fertilizers (roughly 100 to 250 lbs/acre of inorganic-N) is there a similar risk of nitrate leaching from turfgrass? The conventional wisdom is that grass poses a much lower risk of nitrate leaching. It is thought that grass, by virtue of its extensive fibrous root network and dense thatch layer, effectively retains nitrogen fertilizer at the soil surface or within the root zone, thereby preventing soluble nitrates from percolating downward into groundwater (under normal conditions and in most environments).

A review of five nitrate-leaching studies by turfgrass researchers generally confirms this notion for most finely-textured soils (Table 1). For example, mean annual nitrate concentrations in soil water ranged from one to four mg/l in turfgrass studies conducted on fertilized sandy loams or silt loams. Although mean annual nitrate concentrations from turfgrass were relatively low in comparison to crops, they do exhibit a strong seasonal variation. The trend is toward lower nitrate levels in the early growing season (April to August) followed by sharply higher levels during the last stages of the growing season and the entire non-growing season (i.e., September to March when grass roots are no longer taking up nutrients and temperatures are lower). During this interval, nitrate levels in soil water can briefly be as high as two to 10 mg/l (Gross *et al.*, 1990; Geron *et al.*, 1993; Morton *et al.*, 1991).

This is not to imply that turfgrass or home lawns cannot be a major source of nitrate leaching under unique conditions, most notably a combination of sandy soils, high fertilization rates and over-watering. For example, Exner *et al.* (1991) report maximum nitrate levels of 15 to 70 mg/l in leachate from a simulated lawn in Nebraska that met each of these extreme conditions. Indeed, as much as 95% of the applied fertilizer eventually leached during their 34 day experiment. Watts and his colleagues (1991) report mean nitrate levels ranging from 20 to 40 mg/l in over-fertilized, over-watered orchardgrass grown on sandy soils.

Over-watering appears to be the critical variable affecting nitrate leaching from fertilized lawns, even in finely textured soils. For example, Morton *et al.* (1988) recorded the highest rate of nitrate leaching in a simulated home lawn on sandy loam soil that was over-watered and over-fertilized. Since the over-watered lawn resulted in more percolation through the soil, the total mass of nitrogen that leached to groundwater was five to ten times greater than any other lawn management treatment in his study. In contrast, when turfgrass was not irrigated, or irrigation was precisely monitored to only meet the actual water demand of turfgrass, mean nitrate levels seldom exceed two mg/l in leachate, even at higher fertilization rates (Geron *et al.*, 1993; Gross *et al.*, 1990; Mancino and Troll, 1990).

Surprisingly, the form of fertilizer applied (e.g., inorganic vs. slow release) appeared to have little direct effect on the concentration of leached nitrate, in the absence of over-watering. For example, statistical analysis showed that nitrate leachate concentrations were not significantly different when slow release formulations were used in three turfgrass studies situated on finely textured soils (Mancino and Troll, 1990; Geron *et al.*, 1993; Gross *et al.*, 1990). Slightly higher nitrate levels were reported when turfgrass was established by sod rather than seed, which was thought to be due to the lower root mass of the sod (Geron *et al.*, 1993). Lastly, turfgrass researchers disagree about the role of seasonal timing of fertilization, with respect to nitrate leaching. Some have found late season fertilizer applications to increase nitrate levels, while others have found no effect.

In summary, current research generally supports the notion that turfgrass grown on finely textured soils with moderate inputs of nitrogen fertilizer and irrigation does not have the nitrate leaching potential of row crops, nor does it pose a significant risk to potable water supplies. A key exception are over-watered lawns on sandy soils. Even though the nitrate-leaching potential of most turfgrass is relatively low in comparison to many crops, turfgrass nitrate levels still exceed background concentrations of undisturbed land use (forest, meadow, etc.). As a result, lawn fertilization can represent a significant (and controllable) source of nitrogen to coastal waters and embayments that are sensitive to increased nitrogen inputs.

Table 1: Comparison of Nitrate-Nitrogen Leaching Studies. Examining Fertilization Rate, Grass and Soil Type, Irrigation Rate and Other Factors

Study	Soil/ grass type	N applied	Irrigation & management	Treatment	Nitrate Conc. (mg/l)
Geron <i>et al.</i> 1993 Ohio Turfgrass 2 years	Silt loam/ Kentucky Bluegrass	194 lbs/ac/yr	irrigated, but not overwatered turf mowed to 2-3" clippings left in place	Seeded turf	1.09
				Sodded	3.5
				Slow release	1.84
				Fast release	2.74
				Early season fertilization	2.27
				Late season fertilization	2.30
Morton <i>et al.</i> 1988 Rhode Island Simulated lawn 2 years	Sandy loam Bluegrass	none	Slight (a)	Grass moved to 2-3" tall, clippings left in place,	0.51
		none	Overwatered	2 to 3% slope	0.36
		86 lbs/ac/yr	Slight		0.87
		86 lbs/ac/yr	Overwatered		1.77
		217 lbs/ac/yr	Slight		1.24
		217 lbs/ac/yr	Overwatered		4.02
Gross <i>et al.</i> 1990 Maryland Turfgrass 2 years	Sandy loam Tall fescue/ bluegrass	196 lbs/ac/yr	not irrigated, clippings removed	Liquid	1.02
		None		Granular	0.85
				None	0.33
Exner <i>et al.</i> 1991 Nebraska Simulated lawn	sandy loam and sand bluegrass red fescue	214 lbs/ac/yr	overwatered 0.7 inch/day clippings not removed	inorganic	34 to 70 in a pulse
		single application			
Watts <i>et al.</i> 1991 Nebraska 3 years	fine sand, orchardgrass	200 lbs/ac/yr	24" of irrigation/season		~ 22
			37" of irrigation/season		~ 31
		300 lbs/ac/yr	24" of irrigation/season		~ 17
			37" of irrigation/season		~ 28

In addition, current research strongly suggests that efforts to educate homeowners about lawn care should stress the critical connection between fertilization and over-watering. The concept that careless watering can flush nitrogen through the soil and away from the grass that needs it should be strongly emphasized on both economic and environmental grounds. —TRS

#### References

Geron, C. T., Danneberger, S. Train, T. Logan and J. Street. 1993. "Effect of Establishment Method and Fertilization Practices on Nitrate Leaching From Turfgrass." *J. Environ. Quality* 22: 119-125.  
 Gold, A., W. DeRagon, W. Sullivan and J. Lemunyon. 1990. "Nitrate-Nitrogen Losses to Groundwater From Rural and Suburban Land Uses." *J. Soil Water Conserv.* 45: 305-310.

Gross, C, J. Angle and M. Welterlen. 1990. "Nutrient and Sediment Loss From Turfgrass." *J. Environ. Quality* 19: 663-668.  
 Exner, M, M. Burbach, D. Watts, R. Shearman and R. Spalding. 1991. "Deep Nitrate Movement in the Unsaturated Zone of a Simulated Urban Lawn." *J. Environ. Quality* 20: 658-662.  
 Mancino, A and J. Troll. 1990. "Nitrate and Ammonium Leaching Losses From N Fertilizers of 'Pencross' Creeping Bentgrass." *Horticultural Sci.* 25: 977-982.  
 Morton, T, A. Gold and W. Sullivan. 1988. "Influence of Over-Watering and Fertilization of Nitrogen Losses From Home Lawns." *J. Environ. Quality* 17: 124-130  
 Watts, D, G. Hegert and J. Nichols. 1991. "Nitrogen Leaching Losses From Irrigated Orchardgrass on Sandy Soils." *J. Environ. Quality* 20: 355-362.

# Insecticide Impact on Urban Wildlife

**H**omeowners tend to have two conflicting goals. On the one hand, they want to attract wildlife to their property. At the same time, they take great pains to kill bugs that may be eating their lawns and gardens. What many homeowners don't realize is that insecticides can have a serious, even fatal effect on wildlife, especially birds. Insecticides also harm beneficial insects and worms.

The damage is bound to be variable, depending on the kinds of birds and insects involved and the application rate. This variability, rather than reassuring us, calls for much more conservative use of lawn chemicals and some consideration by homeowners about whether insecticides should be used if they also want to prevent wildlife from being poisoned. We have seen how lawn chemicals in runoff impact water quality. The effect of

these chemicals on local wildlife is another reason for reducing their use.

Residual amounts of insecticides that were once thought to be "safe" but have since been discontinued continue to pose a threat to local ecology. Until and unless studies show that pesticides currently in use have little effect on "desired" turf insects and the animals that feed on them, a less chemically dependent approach to landscaping is warranted.

### What Chemical Insecticides Do

The insecticides examined here fall into two basic categories (Table 1). Organochlorines—such as chlordane and dieldrin—have various lethal and sublethal effects on animals. Organophosphates—such as diazinon and chlorpyrifos—inhibit the brain enzymes

Table 1: Some Chemical Insecticides

Chemical	Trade Names	In Use?	Toxicity
<i>Organophosphates</i>			
diazinon	Basudin, Diazol, Garden Tox, Sarolex, Spectracide	Banned on golf courses but permissible on residential turf. Pooling, spillage, overapplication occurs	Paralysis or death from depressed ChE activity; toxic to humans
chlorpyrifos	Dursban, Lorsban, Pyrinex	Yes	Moderate toxicity
acephate	Orhtene	Yes	Contact and systemic
<i>Organochlorines</i>			
dieldrin	Octalox	Discontinued in US	Toxic to humans, absorbed through skin
heptachlor (component of chlordane)	Velsicol, Drinox, Heptamul	Discontinued except as subsurface termiteicide	Toxic to humans, poisoning from ingestion, inhalation, skin contact
chlordane	Toxichlor, Octachlor, Synklor, Corodane, Niran	Discontinued except as termiteicide	Poisoning from ingestion, inhalation, skin contact

cholinesterase and acetylcholinesterase. The nervous systems of all animals depend on these enzymes, therefore any animal can be affected if it receives an adequate dose. There have been more than a few cases where the amount of insecticide applied to turf was enough to kill relatively large animals such as geese (Table 2). Animals that do not eat the grass itself but forage on the ground are also vulnerable.

#### Effects at Ground Level

Certainly it is not desirable to kill all of the insects inhabiting the topsoil and turf. A diverse invertebrate community is necessary for soil maintenance and as the staple diet of many other animals. Chemical insecticides are often advertised as being specially targeted for certain pests—such as chinch bugs in lawns—but in reality the only specificity is in the time of application since any and all invertebrates present in the lawn at the time will be affected to some degree. The relative toxicity of these insecticides to different insects and other invertebrates has not been thoroughly studied.

Arnold and Potter (1987) attempted to find whether the number of “non-pest” insects, spiders and worms is diminished in treated turf. Counts were made of insects and spiders in treated and untreated plots of turf at different times of the year. In particular the response of herbivores and predators was compared. This comparison is prompted by the issue of whether pesticides severely reduce the population of insects and spiders that prey on pest species, thus making pest outbreaks more likely. Arnold’s study found that the effect of insecticides and weed-killers on earthworms, spiders, and non-target insects is unpredictable and that in most cases the plots that experienced a decrease in the population were quickly repopulated.

Most likely, the treated plots were repopulated from neighboring untreated plots. The counts showed that the number of predators (spiders) rises and falls with the number of prey (target insects) in both treated and untreated turf but that the initial decline is much more severe in treated turf.

#### Toxicity to Birds

Decarie *et al.* (1992) investigated the effect of lawn and tree spraying on robins, which have small foraging territories when nesting. Nest productivity was compared in untreated lots and lots in which the lawn was sprayed with diazinon and chlorpyrifos or trees sprayed with diazinon or acephate. In the case of sprayed trees but untreated turf, birds are most likely exposed to the insecticide through the skin rather than from something they ate. Affected adult robins would be expected to be less efficient in feeding their young. The number of surviving nestlings were counted, the behavior of the parents was observed, and some adults were caught for analysis.

No symptoms of poisoning were observed 18 to 24 hours after tree spraying and adults continued to visit nests; however, necropsies showed that brain activity of birds from sprayed trees was significantly less than birds in untreated sites. There was no significant effect on nest productivity and parental behavior; however, productivity for birds in areas where lawns had been sprayed was negatively affected. It would seem that the birds are exposed by feeding and that the feeding habits of the robin make it susceptible to intoxication in treated lawns. For the same reason, species of birds that forage in trees might be affected if trees are sprayed.

The authors point out the many interacting variables in this study. While they conducted a controlled experiment for tree spraying, they had to rely mainly on lawn care records and resident surveys to find treated and untreated lawns. There is some uncertainty about the kind and quantity of chemicals applied to the lawns and the movement of the foraging birds.

The breeding success of birds may be impaired by insecticides—as indicated by Decarie—or individual birds may die from poisoning. In a study by Okoniewski and Novesky (1993), necropsies of dead birds from suburban areas revealed that insecticide poisoning was second to injury as the cause of death (Table 3). In all, 86 poisoned songbirds and 36 poisoned birds-of-prey were diagnosed. Some poisoned mammals were also reported. The discontinued organochlorines persist in the soil and remain a threat decades later, accounting for 17% of songbird fatalities in this study. Cholinesterase activity was depressed in birds poisoned by the organophosphate diazinon.

Linking the concentration of toxin in the poisoned bird to the actual amount of pesticide applied is difficult. Significant levels of pesticides were detected in the soil and in insects and worms from the area (Table 4). This would indicate that the birds were poisoned by ingesting toxic levels of pesticides in their diet. Whether biomagnification (increasing concentration of toxins up the food chain) is actually taking place is difficult to tell without closer analysis of the poisoned animals’ diets. There was a seasonal trend in the deaths of some species—this may indicate the sensitivity of life stages or have something to do with seasonal applications of fertilizer-insecticide mixes sold as one-time, all-purpose products.

**Table 2: Cases of Waterfowl Poisoned From Grazing on Diazinon-Treated Grass (Tietge, 1992)**

- Grass eaten by geese on golf course was 20 ppm; 14 dead Canada geese (1978)
- Grass eaten by Brant geese on golf course contained 79 ppm diazinon (95 ml/100 m<sup>2</sup> application); 700 dead geese (1985)
- 10 dead geese from application of 95 ml/100 m<sup>2</sup> (1985)
- 2.2 kg/ha on golf course—85 dead American widgeon, some sublethally poisoned but killed by predators

**Table 3: Cause of Death in Insect-Eating Birds in Suburban Yards (152 birds, >5 spp.) (Okoniewski and Novesky, 1993)**

Cause of death	(%)
Trauma	26
Organochlorines	17
ChE inhibitors	8
Infectious Diseases	6
Parasites	6
Unknown	37

**Insecticide Persistence and Overuse**

The persistence of discontinued insecticides, such as organochlorines, poses a threat to the local ecology decades after such chemicals have been banned or restricted. The compounds studied by Okoniewski and Novesky did not pose as much a threat to birds and other wildlife than when they were first used in the 1950s. However, as generations of resistant beetles reproduced, greater amounts of the insecticides were applied—ineffectually, since the pest's resistance could be as much as 100-500 fold. Residents were applying the insecticides at up to twice the label dose and frequency (Okoniewski and Novesky, 1993). Long after these insecticides have been discontinued, residuals in the

soil have toxic effects. Two lessons can be learned from this development: 1) increasing the amount of chemical insecticide applied is inefficient and ecologically costly, 2) recorded outbreaks of resistant populations of pests can identify areas that were probably overtreated and where wildlife poisoning is likely to occur.

—JMC

**References**

Arnold, T. B., and D. A. Potter. 1987. "Impact of a High-Maintenance Lawn Care Program on Nontarget Invertebrates in Kentucky Bluegrass Turf." *Environ. Entomol.* 16: 100-105.

Décarie, R., J.-L. DesGranges, C. Lépine, and F. Mourneau. 1992. "Impact of Insecticides on the American Robin (*Turdus migratorius*) in a Suburban Environment." *Environ. Pollut.* 80: 231-238.

Okoniewski, J. C., and E. Novesky 1993. "Bird Poisonings With Cyclodienes in Suburbia: Links to Historic Use on Turf." *J. Wildl. Mgmt.* 57(3): 630-639.

Tietge, R. M. 1992. "Wildlife and Golf Courses." *Golf Course Management and Construction: Environmental Issues*, ed. J. C. Balogh and W. J. Walker. Chelsea, MI: Lewis Pub.

**Table 4: Organochlorine Levels in Soils and Poisoned Birds (Okoniewski and Novesky, 1993)**

Chemical	Soil concentration (ppm)	Concentration in songbird diet (ppm)	Concentration in poisoned songbirds (ppm) and [std. lethal dose]	Concentration in raptors (ppm)
DDE (component of DDT)	0.01-0.21		0.05-23.9 mean 3.30	
Heptachlor (HE)	0.01-0.15	beetles: <=15.6 (HE, OXY)	0.16-15.6, mean 3.195 [9 ppm]	9 ppm
Oxychlordane (OXY)	0.01-0.18	beetles: <=15.6 (HE, OXY)	0.11-10.0, mean 2.59 [1.1 + 3.4 HE]	1.1 plus 3.4 HE
Transnonachlor (TNCH)	0.10-1.24	chlordanes compds (TNCH, a-, b-Chlor): earthworms: 0.2-2.7 cutworms: 0.2 maggots: 0.7-1.0	0.10-42.9, mean 3.87	
Dieldrin	0.01-3.88	earthworms: <= 0.3 cutworms: 0.1 beetles: <= 2.1 maggots: 1.2-2.0	0.03-20.5, mean 4.12 [4 ppm]	4 ppm

# Minimizing the Impact of Golf Courses on Streams

**O**ver 13,000 golf courses now exist in the U.S. and many more will be constructed to meet the growing popularity of the sport. The construction of a new golf course has the potential to create adverse impacts on the aquatic environment. To begin with, a typical 18-hole golf course can convert as much as 100 acres of rural land into a highly "terra-formed" environment of fairways, greens, tees, sand traps, and water hazards. As such, golf courses are often an attractive part of the urban landscape. Haphazardly designed golf courses, however, can disrupt and degrade the wetlands, floodplains, riparian zones, and forests that contribute to stream quality.

A second recurring concern about golf courses are the large inputs of fertilizer, pesticides, fungicides, and other chemicals that are required to maintain vigorous and attractive greens. In many cases, chemical application rates can rival and even exceed those used in intensive agriculture. Table 1 shows a side by side comparison of chemical application rates for a coastal plain golf course and cropland in Maryland, as reported by Klein (1990).

The actual rate of fertilizer and pesticide application rates at a particular golf course can vary considerably, depending on the soil, climate, and management program. As an example, fungicides and nematicides are only lightly used in regions with cold winters, but constitute a major fraction of total pesticide applications in warmer climates. Given such intensive use of chemicals, golf courses clearly have the potential to deliver pollutants to ground and surface waters. Actual monitoring data on pollutant loads from golf courses, however, are quite scarce.

Golf courses are also intensive water consumers, particularly in drier regions of the country. This need for irrigable water can place strong demands on local groundwater and/or surface water supplies, which in turn, can cause baseflow depletion. In addition, the construction of the ubiquitous golf course water hazards can lead to downstream warming in sensitive trout streams.

In the late 1980s, Baltimore County, Maryland was confronted with a wave of golf course development proposals and strong concerns about the possible risk they might have on their Piedmont streams. The Department of Environmental Protection and Resource Management drafted and revised a series of environmental guidelines for new golf course construction. The guidelines stress the importance of integrating the layout of the course with the natural features of the site.

For example, the guidelines require a detailed evaluation of wetlands, perennial and intermittent streams, floodplains, slopes, forest stands and habitat features at the proposed course. The course must be configured to avoid or minimize disturbance to these resource areas. In this respect, long broad fairways are a prime culprit, as they frequently cross or encroach into streams and other buffer areas.

Consequently, the guidelines devote a great deal of attention to the issue of fairway crossings (see Figure 1). For example, no more than two fairway crossings are allowed for each 1,000 feet of stream length. These crossing must be perpendicular to the stream. If forests or wetlands are present at the crossing, this zone must be managed as unplayable rough and remain undis-

**Table 1: Comparative Chemical Application Rates for a Maryland Golf Course and Corn/Soybean Rotation Reported in Pounds/Acre/Year (Klein, 1990)**

Chemical	Cropland	Fairway	Greens	Tees
Nitrogen	184	150	213	153
Phosphorus	80	88	44	93
Herbicides	5.8	10.4	10.2	11.4
Insecticide	1.0	2.0	2.0	2.0
Fungicide	0.0	26.9	34.9	26.9
Total Pesticides	5.8	37.3	45.1	38.3

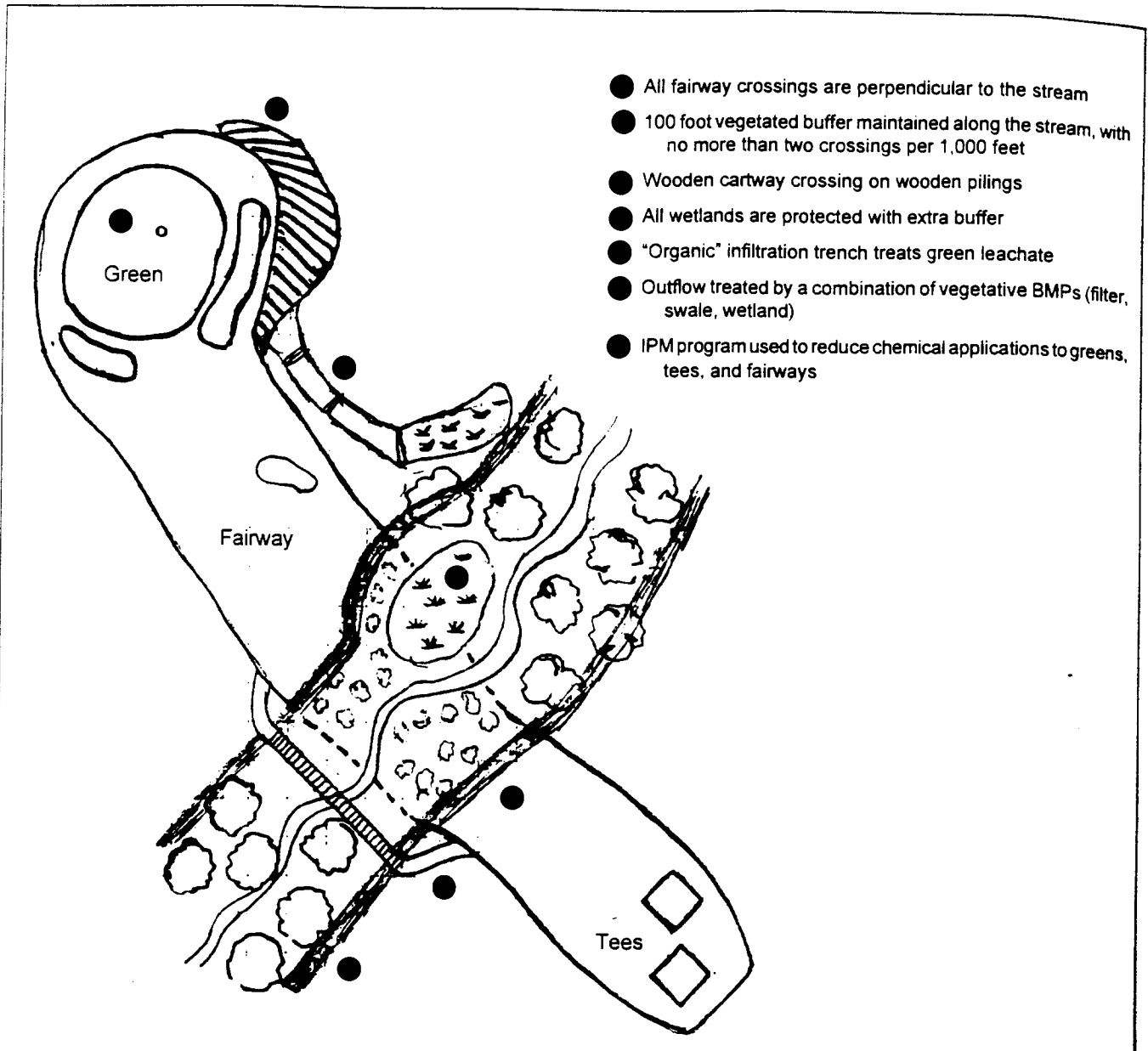

Figure 1: Stormwater Practices for a Golf Course and Stream Crossing (Powell and Jolley, 1992)

turbed as early successional forest or wetland. Cartways and footpaths that cross the stream corridor must be narrow and constructed of timber on wooden pilings. The County guidelines also limit the extent of forest that can be cleared during construction. No more than 25% of the pre-existing forest cover may be removed during course construction.

Constructed ponds are not permitted in trout streams unless they are "zero discharge" facilities constructed in upland areas (see article 82). Best management practices emphasize treatment of greens and tees where nutrient and pesticide applications are greatest. The use of a series of vegetative filtering mechanisms such

as swales, forest buffers, sand filters, and infiltration trenches are recommended.

A common practice for greens is illustrated in Figure 2. To start with, a four-foot-thick mantle of soil is required below the green's underdrain system to prevent leachate from entering groundwater. The leachate is collected in perforated pipes and routed into small depression. This depression is usually filled with layers of organic matter, sand and stone, and then landscaped. The depression acts as both a biofilter and an infiltration facility.

Excess runoff from fairways is also treated by a series of best redundant best management practices (e.g., a grass swale leading to a pocket wetland or

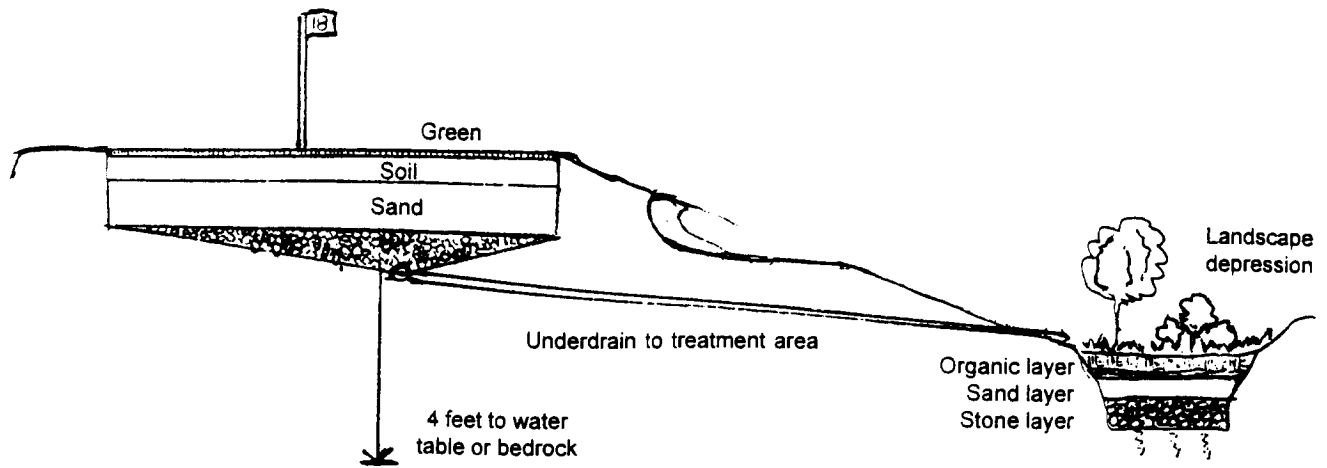

Figure 2: Schematic of a Water Quality Treatment System to Remove Pollutants From a Golf Course Green

irrigation pond that in turn overflows into a forest buffer strip).

Since golf courses are largely pervious in nature, it is not always appropriate to size stormwater practices for water quality treatment based on conventional water quality sizing rules (i.e., based on the amount of impervious area created at the site). Rather, it is more important to ensure proper control of each green, tee, and fairway, and to maximize the use of swales, forest buffers, and wetlands to achieve high rates of treatment.

The Baltimore County guidelines require the installation of permanent sampling wells in addition to periodic monitoring of storm runoff, groundwater, and the biological community present in golf course streams. The guidelines also recognize the importance of integrated pest management (IPM).

The golf course operator must submit an IPM plan that emphasizes the selection of drought and disease resistant turf that requires less maintenance, utilizes biological controls rather than chemicals, and carefully regulates the selection and application of pesticides. The use of slow-release fertilizers is also encouraged to minimize the leaching of nitrates into groundwater.

To date, the guidelines have been applied to seven new golf course development proposals in Baltimore County with the active cooperation from the golf design community. Preliminary storm and groundwater monitoring data from several golf courses designed under the new guidelines indicate that they appear to have little impact on water quality, with the possible exception of nitrate leaching. Additional storm monitoring data is expected at both public and private

courses over the next two years to attempt to confirm this observation.

—TRS

#### References

- Klein, Richard D. 1990. *Protecting the Aquatic Environment From the Effects of Golf Courses*. Community & Environmental Defense Assoc. Maryland Line, MD.
- Powell, R.O. and J.B. Jollie. 1993. *Environmental Guidelines for the Design and Maintenance of Golf Courses*. Baltimore County Dept. of Environmental Protection and Resource Management.



# Groundwater Impacts of Golf Course Development in Cape Cod

**G**olf courses are a unique form of urban development in that they produce relatively little runoff but possibly a great deal of pollution. The unusually high rates of fertilizers and pesticides applied to tees, greens, and fairways have always made golf courses a prime water quality suspect. Until recently, however, no monitoring data was available to support or refute the argument that golf courses can contaminate groundwater.

Three years of detailed groundwater monitoring has recently been completed on four golf courses near Cape Cod, Massachusetts by Cohen and his colleagues (1990). Sandy soils in this coastal region contribute to a sole-source aquifer, so concerns about the quality of groundwater supplies are paramount. Each of the four golf courses were selected to represent the worst risk for possible groundwater contamination: each was underlain by sandy soils of glacial origin, had above-normal pesticide and nutrient applications, and had been continuously operated for up to 30 years. Each of

these three factors likely promote greater movement of pollutants in groundwater.

Three years of monitoring at 19 test wells detected 10 out of 17 pesticides (see Table 1). Most pesticides were present in low concentrations (less than five ppb), and were associated with greens and tee areas. The most frequently detected compound was 2-4-dichlorobenzoic acid (DCBA), an impurity associated with herbicides. Technical chlordane was also frequently detected, despite the fact that its use on turfgrass had been banned since 1978. Chlordane is highly persistent, but relatively immobile in the soil environment (see Table 2), and appears to be leaching slowly into the groundwater in the 12 years since it was banned. With the exception of chlordane, no pesticide found in groundwater exceeded health guidance levels.

The monitoring study also tracked nitrate-nitrogen levels in the golf course groundwater (Table 3). Current golf course standards require that the soil medium underlying greens and tees be composed of at least 95% sand, so it is not surprising that nitrate levels were considerably elevated compared to non-golf course control sites. Maximum nitrate levels in excess of 10 mg/l were occasionally recorded, but averaged one to six mg/l. While the groundwater nitrate levels were thought to be no worse than reported for intensively fertilized agricultural areas, they are clearly high enough to create eutrophication problems in coastal or near coastal nitrogen sensitive waters.

**Table 2: Relative Mobility and Persistence of Selected Pesticides (Cohen *et al.*, 1990)**

<i>Mobility in Soil Environment</i>		
<b>High Mobility</b>	<b>Medium Mobility</b>	<b>Low Mobility</b>
2,4-D	Siduron	Chlordane
Dicamba	PCP	Heptachlor epoxide
Dacthal diacid	Iprodione	Dacthal
MCPP	Diazinon	Chlorothalonil
	Isofenphos	Chlorpyrifos
		Anilazine
<i>Persistence in Soil Environment</i>		
<b>High Persistence</b>	<b>Medium Persistence</b>	<b>Low Persistence</b>
Chlordane	Dicamba	2,4-D
Siduron	Dacthal diacid	Dacthal
PCP	Iprodione	MCPP
Heptachlor epoxide	Diazinon	
	Isofenphos	
	Chlorothalonil	
	Chlorpyrifos	
	Anilazine	

**Table 1: Pesticides Detected in Golf Course Groundwater Wells**

<b>Pesticide</b>	<b>Detection Rate</b>
2-4-dichlorobenzoic acid (DCBA)	63%
Technical Chlordane *	44%
Total Dacthal residues	19%
Chlorothalonil	13%
Isofenphos	13%
Chlorpyrifos	6%
Dicamba	6%
2-4-dichloro-phenol (2-4D)	6%

\* banned on turfgrass since 1978

**Table 3: Nitrate-Nitrogen Levels in Groundwater of Four Golf Courses in Cape Cod, Mass All Values in mg/l (Cohen *et al.*, 1990)**

Golf Course	Green	Tees	Fairway	Reference Site	Maximum Value (d)
Bass River	2.79	1.03	4.16	8.0 (b)	10.0
Eastward Ho!	6.31	1.0	6.66	0.10	30.0
Falmouth (a)	2.44	1.54	ND	0.10	6.5
Hyannisport	5.82	2.24	3.24	0.10	10.2
MEAN	4.34	1.45	4.68	0.10(c)	—

- (a) Falmouth course utilized slow release fertilizers during study.  
 (b) Background reference site appears to have been contaminated.  
 (c) Mean computed without outlier.  
 (d) Recorded from green, tee, or fairway well.

The researchers found considerable evidence that nitrate leaching could be reduced through better fertilizer management. For example, Cohen *et al.* noted that the golf course (Falmouth) that utilized slow release fertilizers had sharply lower groundwater nitrate levels than all other sites. They also observed a significant decline in nitrate levels in years where fertilizer applications were below normal.

The researchers caution that the findings pertain to only one of many hydrogeologic settings, and more extensive groundwater monitoring in other regions is needed to fully define the water quality risks of golf courses. Southern courses in particular remain a monitoring priority as their irrigation rates and nematicide and fungicide applications tend to be much greater than Northern courses.

Although much more monitoring needs to be done to fully assess the groundwater impact of golf courses, Cohen's study does reinforce the great potential for improved nutrient and pest management practices to protect groundwater at golf courses. Through relatively simple changes in how and when chemicals are used, golf course managers can help protect water quality and still provide an attractive and durable playing surface.

—TRS

#### References

- Cohen, S., S. Nickerson, R. Maxey, A. Dupuy and J. Senita. 1990. "A Groundwater Monitoring Study for Pesticides and Nitrates Associated With Golf Courses on Cape Cod." *Groundwater Monitoring Review*. Winter 1990:160-173.
- Petrovic, A. 1990. "The Fate of Nitrogenous Fertilizers Applied to Turfgrass." *Journal of Environmental Quality*. 19(1): 1-14.



# **Pollution Prevention At Work**

R0080129



# Practical Pollution Prevention Practices Outlined for West Coast Service Stations

**G**asoline, motor oil, diesel fuel, antifreeze, tires, transmission fluids, brake fluid, batteries, auto paint, and solvents are just some of the many fluids and materials that cycle through a typical service station over the course of a day. It is therefore not surprising to find that service stations are a major stormwater *hotspot* in the urban landscape.

Even though they are small in size, service stations can generate significant loads of hydrocarbons, metals and other pollutants. The pathways include car washing, engine steam cleaning, spills of oil and gas, parts cleaning, leakage from wrecked vehicles, and exposure of automotive products and wastes to stormwater.

Indeed, for many years, the most common cleaning practice at service stations was to hose off workbays and fueling surfaces directly into the floor drain in the shop, or into a storm drain. With the advent of pretreatment requirements, most floor drains can no longer be connected to the sanitary sewer unless expensive pretreatment is provided. Thus, it is very likely that most gas station pollutants will be eventually be discharged into the storm drain system, and ultimately into our streams and rivers.

Can stormwater pollutant loads from service stations be prevented or minimized? A recent manual by the Santa Clara Valley Nonpoint Source Control Program outlines 15 low-cost pollution prevention steps that can be implemented (Table 1). This short manual is targeted to owners and operators of service stations and other vehicle maintenance operations. It outlines a series of simple shop activities and procedures that greatly reduce the risk of spills, leaks, or washoff of pollutants.

The pollution prevention approach is based on three basic principles. The first is the goal of running a dry shop, such that potential pollutants are kept from contact from storm or wash water. The second principle involves *zero-discharge*, whereby floor drains are sealed, and all automotive wastes are recycled, reused, or safely stored until hauled away for disposal. The third principle involves the thorough education of employees and customers on the day-to-day practices for safely handling, recycling, or disposing of automotive products.

The recommended pollution prevention practices are also sound from a business standpoint. They can

result in savings to the operator in terms of reduced product inventory, reduced quantities and expense for hazardous waste disposal, and reduced liability for spills and other pollution events. A key feature of the manual is a list of agency and vendor contacts for recycling and disposal of automotive fluids, tires, batteries, and solvents.

At this point, it is hard to quantify the degree of pollutant reduction that can be achieved through the pollution prevention approach. A possible test would be to monitor priority pollutant concentrations in the sediments and pool water of oil/grit separators serving gas stations that practice pollution prevention and compare the results with those that do not. The differences between them should be a good indicator of the effectiveness of this approach.

—TRS

## Reference

Santa Clara Valley Nonpoint Source Control Program. 1993. *Best Management Practices for Automotive-Related Industries*. 15 pp.

**Table 1: Fifteen Recommended Practices to Prevent Stormwater Pollution from Service Station/Auto Repair Areas (Santa Clara Valley Nonpoint Source Control Program, 1993)**

1. Prevent discharges when changing automotive fluids.
2. Use drip pans when working on engines.
3. Use special care to prevent leaks from wrecked vehicles.
4. Quickly cleanup spills of all sizes.
5. Keep wastes from entering floor drains and storm drains.
6. Use concrete surfaces and roofing over fueling areas to prevent spilled fuel from contact with stormwater.
7. Properly store and recycle used batteries.
8. Clean parts without using liquid solvents (or use solvent recyclers).
9. Capture all metal particles during grinding and finishing operations.
10. Properly store and recycle waste oil, antifreeze and other automotive fluids.
11. Select "environmentally friendly" products and control inventory to reduce wastes.
12. Keep all working areas inside and away from stormwater.
13. Treat all liquid streams from car washing and engine cleaning.
14. Train employees on pollution prevention activities for the shop.
15. Educate customers on proper recycling and/or disposal of automotive products.

# Practical Pollution Prevention Emphasized for Industrial Stormwater

by L. Donald Duke, Assistant Professor, University of California, Los Angeles

**A**utomotive service stations have been characterized as potential "hot spots" for hydrocarbon pollutants and heavy metals in urban storm water discharges. In an urban area, industrial activities can also be considered hot spots as sources of pollutants. While residential and commercial land uses typically account for the majority of the mass of pollutants discharged in runoff from an entire urban region, routine or accidental discharges from a few industrial facilities can discharge pollutants such as petroleum hydrocarbons, heavy metals, and toxic organic materials in quantities far beyond the proportion of industrial land use.

Pollutants from a single industrial hot spot could outweigh the gains of a regional program's entire campaign of information-based residential pollution controls. This is the reason that industrial activities continue to draw attention from regional storm water pollution control programs, even though industrial facilities are addressed by federal and state-level National Pollutant Discharge Elimination System (NPDES) stormwater regulations.

The practical pollution prevention measures for automotive-related industrial activities developed by the Santa Clara Valley Nonpoint Source Program make up part of the Santa Clara Valley program's pollution prevention outreach efforts for private industry. A second document is designed to address construction activities, with their obvious potential for short-term stormwater impacts by disturbing soils and ecosystems. A third, described here, promulgates stormwater management practices intended for general industrial facilities. Industrial activities, even small businesses and relatively small facilities, have the potential to be stormwater pollutant hot spots if the facility operator does not pay attention to routine operations that may discharge pollutants.

The "operational practices" approach to pollution prevention can be especially attractive to smaller facilities, which may not generate pollutants in the large and regular quantities that make hydraulic treatment methods feasible but which nevertheless can be occasional sources of significant amounts of pollutants. Further, small businesses may not have the wherewithal to implement extensive structural controls or to develop in-house expertise on specialized environmental issues, but need to comply with U.S. EPA stormwater

NPDES regulations issued in 1992. The Santa Clara Valley program's stormwater practice manual is designed to be practical for smaller businesses: it is a highly readable document, features easy-to-follow recommendations, and lists measures that can be incorporated into everyday practices.

The intent of the pollution prevention approach is to control pollutants so well that stormwater need not be treated in a hydraulic detention facility or a pollutant removal device. The approach is highly practical from a business standpoint because it focuses on industrial operations and low-cost pollution control practices rather than expensive constructed solutions like new industrial structures or new storm water detention or treatment facilities. This approach is especially preferable in the kind of highly seasonal semi-arid rainfall regimes that are found in much of California and most of the western U.S.

The Santa Clara Valley document's pollution prevention approach utilizes three basic principles: (1) prevent stormwater from contacting working areas; (2) keep pollutants off surfaces that do come into contact with water; and (3) if necessary, manage stormwater before it is discharged to the storm drain (i.e., promote infiltration into the soil or install devices to remove pollutants). The approach emphasizes changing everyday operating routines in a way that prevents stormwater pollution, and suggests using structural practices only after it has been demonstrated that operational practices are not sufficient to control pollutants.

Industrial pollution prevention practices can be divided into four groups (see Table 1). The first two categories concentrate heavily on operational practices and pollution prevention methods. Stormwater practices in this first group include some that the Santa Clara Valley program recommends to all industrial facilities: employee training, customer awareness, spill prevention, and eliminating non-stormwater discharges. The second includes pollution prevention practices that may be conducted at a typical facility (e.g., methods for handling wastes, pollution prevention for outdoor equipment, and proper methods of building and grounds maintenance, vehicle maintenance, shipping and receiving, and equipment washing).

The third group may entail some structural modifications to an industrial facility to enhance pollution prevention: design features for loading dock areas,

vehicle fueling and maintenance areas; access roads on the plant site; and rail facilities on the plant site. The fourth group describes in brief outline some hydraulic control stormwater practices and pollutant removal practices that can be implemented if necessary. Hydraulic detention and treatment approaches are not emphasized, although some facilities elsewhere in the U.S. use these as the cornerstone of their stormwater compliance efforts.

Ongoing research around the U.S. continues to focus on industrial stormwater pollution, including characterization of pollutants conveyed in storm drains from industrial areas and promulgation of pollution prevention controls for industrial facilities.

Additional research is ongoing at UCLA to better characterize industrial discharges. The self-monitoring requirements for industry that are included in the current round of regulations will address this to some extent. However, the range of substances and concentrations that we can typically expect in stormwater discharges from industrial activities is not currently being evaluated in any integrated, comprehensive nationwide program, and only in a fragmented fashion in a few region-wide programs. This kind of information will be necessary if regulatory agencies intend to develop guidelines for required stormwater practices, design criteria for structural controls, and capability to predict costs and effectiveness of industrial storm water pollutant control programs.

#### References

Santa Clara Valley Nonpoint Source Pollution Control Program. 1992. Duke, L.D. and Shannon, J.A. *Best Management Practices for Industrial Storm Water Pollution Control*.

**Table 1: Industrial Stormwater Practices**

**A. Storm water pollution prevention practices recommended for all industrial facilities**

- Training and education for employees and customers
- Eliminating improper discharges to storm drains
- Spill prevention, control, and cleanup

**B. Categories of industrial activity for which pollution prevention practices may be adequate for stormwater control**

- Outdoor process equipment, operations, and maintenance
- Outdoor materials storage and handling
- Waste handling and disposal
- Vehicle and equipment washing and steam cleaning
- Trucking and shipping/receiving
- Fleet vehicle maintenance
- Fueling fleet vehicles and equipment
- Building and grounds maintenance
- Building repair, remodeling, and construction

**C. More extensive practices that may be needed for some industrial activities**

- Loading dock design features
- Equipment yard design features
- Fleet or equipment fueling area design features
- Controls and design features for access roads and rail corridors

**D. "Last-resort" storm water management and treatment controls**

- Onsite storm water management
- Redirect discharge from storm drain to sanitary sewer
- Storm water management: hydraulic controls
- Storm water management: water quality (treatment) controls
- Storm water management: removing oily contaminants (treatment controls)



# Milwaukee Survey Used to Design Pollution Prevention Program

by Jonathan Simpson, Tetra Tech, Inc., Fairfax, VA

**T**he public needs to be educated about nonpoint source pollution!" cries the Urban Stormwater Manager. "Videos are hot — let's do a video, debut it at a public meeting, and then put a dozen copies in the library for people to check out."

How effective is this approach? Not very, according to a recent survey of over 3,000 residents in the lower Milwaukee River watershed. Researchers at the University of Wisconsin-Madison Environmental Resources Center report that people have a willingness to learn and make personal lifestyle changes to help the water environment, but they much prefer a passive approach to the education process (Nowak *et al.*, 1990). Television news reports, newspaper articles, and a community newsletter delivered to the home were cited as the best ways to get people to take notice of water resource issues (Figure 1).

Traditionally, citizens have been considered the weak link in nonpoint source pollution prevention pro-

grams. In spite of intensive education efforts, some unenlightened residents continue to exacerbate local water quality problems by overusing chemical fertilizers, improperly dumping yard wastes, exposing soil to erosion, and allowing litter and pet wastes to move off their property.

Even more striking is the public's ignorance about new advances in stormwater management that can result in better local stream and wetland protection. Consequently, local opportunities to install innovative stormwater practices or stormwater retrofits routinely pass by planning and zoning boards without much public comment or involvement. Is it that people are uninterested? ... uncaring? ... Or are they just not properly plugged into the pollution prevention process?

"The underlying goal of the Milwaukee River Program survey," says Carolyn Johnson, Urban Water Quality Educator for University of Wisconsin Exten-

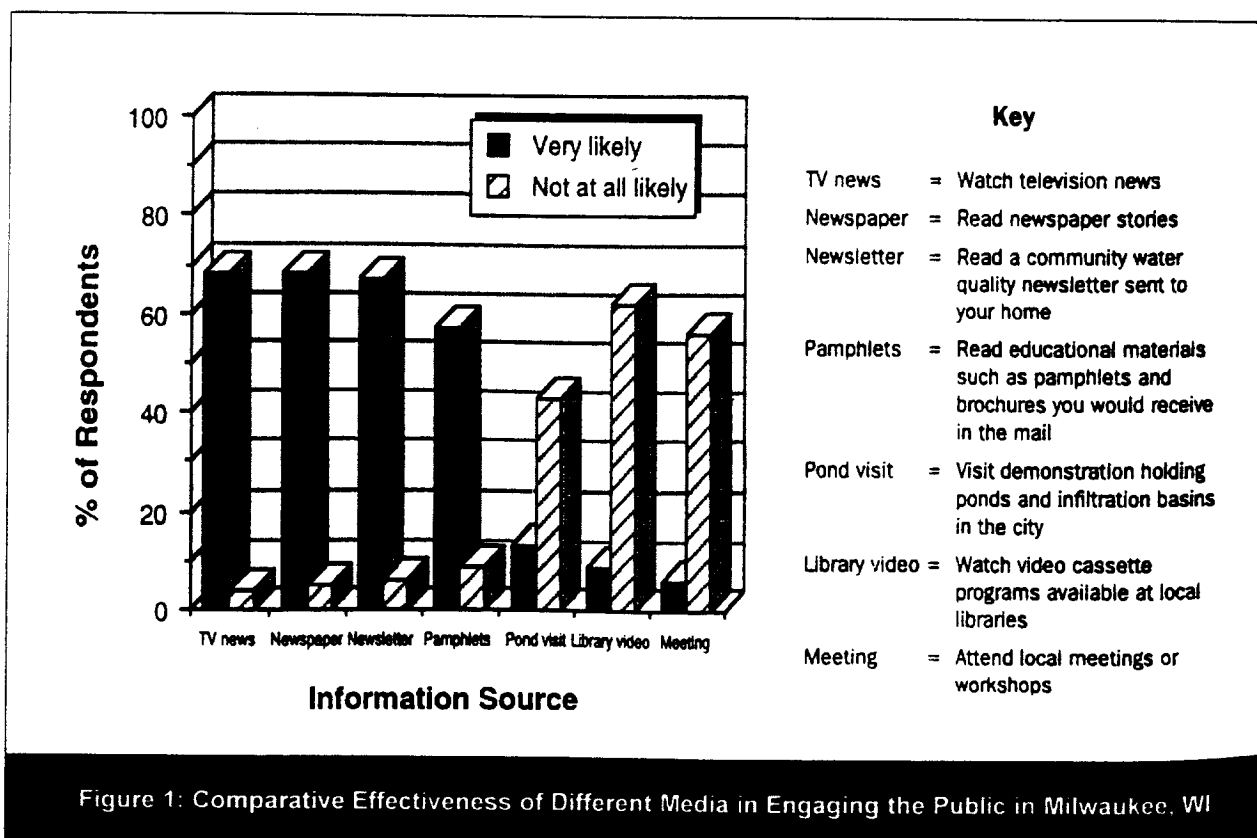

Figure 1: Comparative Effectiveness of Different Media in Engaging the Public in Milwaukee, WI

sion. "was to directly reach out to citizens to learn their views about water quality, the recreational use of area waters, and potential involvement in surface water protection." In 1989 a multi-page questionnaire was mailed to 5,500 residents in the lower Milwaukee River Basin to find answers. The pool was randomly selected from state driver's license files maintained by the Department of Transportation. A well-designed system of pre- and post-survey contact resulted in a response rate of 55%.

Recipients were asked to respond to questions in seven topic areas. Some of the significant results are discussed below.

#### 1. Perception of Water Quality

Virtually all the local waters were rated poor to fair by respondents. Sixty percent of the people from the City of Milwaukee rated the quality of the Milwaukee River as poor. The primary reason for the negative attitude was that the water appeared "dirty."

#### 2. Use of Lakes and Streams

The perception of poor water quality, coupled with limited knowledge of recreational opportunities in the basin, limits the number of people that use local water bodies for recreation. Instead, people seek their water recreation opportunities elsewhere. For example, 47% of the respondents from Milwaukee indicated that they fish, but only one to 2% fish in local waters other than the Milwaukee River, and only 5% use the Milwaukee River.

#### 3. Knowledge of Causes of Water Quality Problems

Most urban residents (55%) believe that point sources such as sewage treatment plant outfalls and industrial discharges were the major cause of water quality problems in the watershed. Nonpoint source pollution sources such as construction sites and street runoff were not recognized as important.

#### 4. Acceptance of Stormwater Practices

The design and function of grassed swales, stormwater ponds, and infiltration basins were briefly described in the survey form. Approximately 40 to 50% of survey participants thought that these stormwater practices should be required in new development. Only 10 to 25% opposed the requirement of these practices. The rest were unsure.

#### 5. Preferred Format for Receiving Water Education

Of particular interest were questions regarding preferences on how the pollution prevention message should be delivered. Only 6% of the respondents said they were "very likely" to attend meetings or workshops on the subject. About 55% said they were "not at all likely" to attend. The information sources rated "most interest-

ing" were the television news and a community water quality newsletter delivered to the home.

#### 6. Willingness to Take Action to Prevent Pollution

Over 90% of the respondents indicated that they are willing, or already do, a number of things to protect water quality. These include taking used automotive oil to a recycling center, separating household hazardous wastes and recyclable material from other trash, limiting use of chemical fertilizers and weedkillers to one application per year, and supporting an ordinance requiring dog owners to clean up their dog's waste.

#### 7. Willingness to Pay for Improvement Efforts

More than half of the respondents said they were willing to pay \$50 or more per household per year for programs to protect and restore local lakes and streams within a time frame of eight to 10 years. Interestingly, they would be willing to pay even more (about \$75 per household per year) for more aggressive programs that would produce results in one to two years.

Much time, effort, and money is currently being invested in the production and distribution of watershed education materials to the public. Are these resources being spent wisely? The "cart is before the horse" if knowledge and behaviors of the targeted citizens are not assessed at an early stage.

The Environmental Resources Center at the University of Wisconsin-Madison, in cooperation with the Wisconsin Department of Natural Resources and the Milwaukee River Basin Citizen Advisory Committee, provided the foundation necessary for developing a successful pollution prevention campaign in the lower Milwaukee River basin. Watershed practitioners are now using the results for community outreach efforts. Elected officials have been enthusiastic about voter support for cleanup efforts. Most important, citizen opinions have been included upfront in water resource protection and restoration efforts.

Planning an effective outlet for the public educational message is critical. This survey provides evidence that traditional media used by agencies (meetings, brochures, fact sheets) are rejected by a large majority of respondents. Instead, people prefer the comfort and (perceived?) legitimacy of the mass media. Given this knowledge, watershed practitioners should work to increase access and use of local television, newspapers, magazines, and radio when establishing citizen outreach campaigns.

#### References

- Nowak, P.J., J.B. Petchenik, D.M. Carman and E.B. Nelson. 1990. *Water Quality in the Milwaukee Metropolitan Area: The Citizens' Perspective*. Report submitted to WI Dept. of Nat. Res. and the Milwaukee River Basin Citizen Advisory Comm.

# Rating Deicing Agents: Road Salt Stands Firm

**W**atershed managers frequently wonder if there are any practical alternatives to the use of road salt for keeping roads free of ice in the winter. Others are concerned about the impact of chlorides on downstream water quality or on adjacent plants. A Michigan study suggests that despite the development of alternatives, road salt (primarily sodium chloride, NaCl) generally remains a competitive choice based on environmental, infrastructural, and cost factors.

Most northern states have traditionally employed road salt as a primary chemical deicer (Table 1) and sand as an abrasive (for better traction). Although sodium chloride is an inexpensive and effective choice, concerns are frequently raised about its potential negative impacts—particularly from chloride—on human health, the environment, highway infrastructure, and vehicles (see Table 2). Alternate deicing agents are not free of controversy either. For example, some localities employ urea to protect critical infrastructure (such as bridges or airports) from corrosion due to chlorides. Application of urea, however, may increase nutrient loading of waterways. In an era of ever-decreasing budgets, cost is an important factor that will often determine the type of deicer to be used. Lastly, and most importantly, highway departments must be confident that a given deicing agent will provide safe roads in winter driving conditions.

To respond to these concerns, the Michigan Department of Transportation (MDOT) analyzed the comparative performance, environmental impacts, and costs of six deicing agents: road salt (sodium chloride, the most common deicer in Michigan); calcium magnesium acetate (CMA); CMS-B (also known as Motech, a patented product containing primarily potassium chloride and derived as a by-product of beet processing); CG-90 Surface Saver (a patented corrosion-inhibiting salt); calcium chloride; and Verglimit (a patented concrete road surface containing calcium chloride pellets). Sand was also included in the evaluation. The primary components of the selected deicing agents were also compared (Table 3). In addition, MDOT briefly evaluated ethylene glycol, urea, and methanol. Due to their poor performance, environmental and human health effects, or high cost, these three agents were dropped from consideration as practical deicing alternatives.

As might be expected, each deicer has a different combination of performance, costs, and impacts. This suggests that different deicers may be appropriate for different climatic regimes in the country. None of the seven deicers was considered to possess widespread adverse environmental threats; however, they can exert site-specific impacts depending on the deicing agent's runoff concentration. Impacts may be significant for many threatened and endangered species which are already stressed and habitat-limited, small streams and lakes, water supplies, and wetlands and swales. A comparison of the potential impacts of the seven deicing agents (Table 4) can help users choose the deicer(s) most suitable for a particular area.

**Table 1: Typical Elemental Composition of Two Road Salt Samples (Biesboer and Jacobson, 1994)**

Element	Concentration (ppm)
Sodium (Na)	349,714.0
Chlorine (Cl)	539,259.0
Calcium (Ca)	4,573.5
Potassium (K)	187.5
Iron (Fe)	73.9
Magnesium (Mg)	55.7
Aluminum (Al)	27.7
Lead (Pb)	6.7
Phosphorus (P)	4.6
Manganese (Mn)	3.1
Copper (Cu)	2.0
Zinc (Zn)	1.9
Nickel (Ni)	1.7
Chromium (Cr)	1.1
Cadmium (Cd)	0.4

Note: concentrations are typically diluted by one to three orders of magnitude in urban stormwater and streams. Elemental nitrogen was not analyzed.

The study also compared the effectiveness of deicing agents with respect to minimum activation temperatures, corrosion, and estimated cost (Figure 1). Unfortunately, environmental costs are difficult to quantify and are not included. One of the deicing agents, CMS-B, is a new product, and only limited data is available on its performance and cost.

The study did identify some potential alternatives to the use of sodium chloride. For example, calcium chloride applied in pellet or liquid form could be the most attractive deicer for areas where fast melting is a priority. It also causes less corrosion and is only 10 to 15% more expensive per road mile than road salt. Verglimit contains calcium chloride, but has relatively low deicing ability—a result of its significantly lower concentration of the salt and tendency to absorb water, rendering it largely ineffective at lower temperatures.

In regions where the environmental and corrosive effects of deicers are important management issues, CMA may be the preferred choice. However, CMA only works above 23°F, has less deicing ability, and is the most expensive option (Figure 1).

Road salt will probably continue to be an attractive deicing agent because of its high deicing ability, utility at low temperatures, and low cost. The report suggests that corrosive effects from road salt can and have been reduced through design and material modifications to both road structures and vehicles over the past several years. Such developments may make road salt even more attractive as a deicing agent. Consequently, management measures should be taken to minimize runoff containing road salt and other deicing agents into sensitive environmental areas (Table 5). It is important to remember, however, that the study specifically analyzed the usefulness of deicing agents in Michigan; as a result, other regions may wish to evaluate agents in the context of their particular floral, faunal, infrastructural, and economic conditions.

—RLO

## References

- Anonymous. 1995. "Less Road Salt on Vermont Highways." *Nonpoint Source News-Notes* 39: 17-18.
- Biesboer, D.D. and R. Jacobson. 1994. *Screening and Selection of Salt Tolerance in Native Warm Season Grasses*. Minnesota Department of Transportation. Report 94-11. 33 pp.
- Massachusetts Audubon Society. *A Low-Salt Diet for the Roads*. Public Service Information Sheet 12. Lincoln, MA.
- Michigan Department of Transportation. 1993. *The Use of Selected Deicing Materials on Michigan Roads: Environmental and Economic Impacts*. Lansing, MI. Prep. by Public Sector Consultants, Inc.

**Table 2: Some Impacts of Road Salt (MDOT, 1993)**

- Contamination of drinking water supplies
- Corrosion of automobiles (50% of automobile corrosion is due to road salt, although this number is declining due to the increased use of corrosion-resistant materials in vehicles)
- Corrosion of bridges and other infrastructure
- Damage to vegetation within 50 ft. of roadside
- Temporary reduction in soil microbes, followed by summer recovery
- Sensitivity of various deciduous trees (see Technical Note 56)
- Attraction of deer to salts on roadways, increasing the risk of accidents
- Stratification of small lakes, hindering seasonal turnover
- Secondary components (3-5% of road salt composition) include N, P, and metals in concentrations exceeding those in natural waters

**Table 3: Primary Components of Selected Deicing Materials (MDOT, 1993)**

Deicing Material	Primary components*	Chloride as fraction of total mass
Calcium magnesium acetate (CMA)	Ca, Mg, C <sub>2</sub> H <sub>3</sub> O <sub>2</sub>	0%
Calcium chloride	Ca, Cl	>57%
Calcium chloride (Verglimit)	Ca, Cl	2.2 to 4.8%
Sodium chloride (road salt)	Na, Cl	~58%
Corrosion inhibitor (CG-90 Surface Saver)	Na, Cl and Mg, Cl	46% 17%
Potassium chloride (CMS-B/Motech)	K, Cl	Unknown
Sand	Si, O	0%

\* Ca = calcium; Mg = magnesium; C<sub>2</sub>H<sub>3</sub>O<sub>2</sub> = acetate; Cl = chloride; Na = sodium; K = potassium; Si = silicon.

**Table 4: Impacts of Selected Deicer Components and Products on the Environment (MDOT, 1993)**

	Sodium Chloride (NaCl)	Potassium Chloride (KCl)	Calcium Chloride (CaCl <sub>2</sub> )	CG-90 Surface Saver	CMA (CaMgC <sub>2</sub> H <sub>3</sub> O <sub>2</sub> )	Sand (SiO <sub>2</sub> )
Soils	Cl complexes release heavy metals; Na can break down soil structure and decrease permeability	K can exchange with heavy metals, releasing them into the environment	Ca can exchange with heavy metals, increase soil aeration and permeability	Same as NaCl; Mg can exchange with heavy metals	Ca and Mg can exchange with heavy metal	Gradually will accumulate on soil
Vegetation	Salt spray/splash can cause leaf scorch and browning or dieback of new plant growth up to 50' from road; osmotic stress can result from salt uptake; grass more tolerant than trees and woody plants				Little effect	Accumulates on and around low vegetation
Groundwater	Mobile Na and Cl ions readily reach groundwater, and concentration levels can increase in areas of low flow temporarily during spring thaws. K, Ca, and Mg can release heavy metals from soil					No known effect
Surface Water	Can cause density stratification in small lakes having closed basins, potentially leading to anoxia in lake bottoms; often contain nitrogen, phosphorus, and trace metals as impurities, often in concentrations greater than 5 ppm				Depletes dissolved O <sub>2</sub> in small lakes and streams when degrading	No known effect
Aquatic Biota	Little effect in large or flowing bodies at current road salting amounts; small streams that are end points for runoff can receive harmful concentrations of Cl; Cl from NaCl generally not toxic until it reaches levels of 1,000-36,000 ppm; Cl from KCl may be more toxic; eutrophication from phosphorus in CG-90 can cause species shifts				Can cause oxygen depletion	Particles to stream bottoms degrade habitat

**Table 5: Suggestions to Help Reduce Excessive Deicing Agents (Particularly Road Salt) Runoff (Nonpoint Source News-Notes, 1995; MA Audubon Society and VT Agency of Transportation, 1993)**

**Storage**

- Salt storage piles should be completely covered and handled on impervious surfaces.
- Runoff should be contained in an appropriate area.
- Spills should be cleaned up after loading operations. The material may be directed to a sandpile or returned to salt piles.

**Application**

- Instead of applying deicers at the same rate on high- and low-volume roads, control measures should be tailored to conditions.
- Trucks should be equipped with ground-speed sensors that automatically control the spread rate of the material.
- Drivers and handlers of road salt should attend training programs to improve efficiency and reduce losses.
- Drivers should avoid plowing snow from treated surfaces into piles or near frozen ponds, lakes, or wetlands.

**Additional Suggestions:**

- Identify ecosystems such as wetlands that may be sensitive to salt.
- Use calcium chloride and CMA, which are more costly than sodium chloride but may be less environmentally harmful to sensitive ecosystems.
- Apply sand to help traction and reduce salt. However, excessive sanding is an additional expense and poses sedimentation problems.
- To avoid overapplication and excessive expense, choose deicing agents which perform most efficiently according to pavement temperature.
- Monitor the deicer market, which changes as new products are developed, existing ones are developed more cheaply, and more is learned about their application and effects. While the purchase price of road salt alternatives is usually high, their full cost may actually be lower when the cost of contaminated water supplies, corroded vehicles and highways, and roadside vegetation loss is considered.
- Use stormwater practices, such as buffer zones, to further protect sensitive areas.

Figure 1: Comparison of Deicers' Effectiveness and Cost (MDOT 1993)

	Deicing ability	Corrosion protection	Minimum effective temperature (from lab tests)	Material costs per ton	Total direct cost per E-mile *
Sodium chloride			12°F (-11°C)	\$20 - 40	\$12,741 - 13,818
Calcium chloride			-20°F (-29°C)	\$200	\$13,953-15,057 plus storage and equipment costs
Calcium magnesium acetate			23°F (-5°C)	\$650 - 675	\$25,915 - 32,637
CG-90 Surface Saver			1°F (-17°C)	\$185	\$11,861-12,296
Verglomit			25°F (-4°C)	\$109 - 145 (3X cost of regular asphalt overlay)	Not available †
CMS-B	Unknown	Unknown	-10°F (-23°C)	\$0.40 - 0.50 / gal.	Not available
Sand			Not available	\$5	\$9,508 - 10,215 (Road salt / sand mixture)

\* Unless otherwise noted, direct cost includes procurement of materials, personnel, corrosion, storage, and equipment. An e-mile, or "equivalent mile," is one mile of 24-foot-wide (two-lane) road surface.  
 \*\* Questions have been raised about the longevity of CG-90 Surface Saver's corrosion protection.  
 † Verglomit is also a road surface; therefore it offers more than deicing alone, making its costs difficult to compare with other deicers.

# Pollution Prevention for Auto Recyclers

**A**uto recycler facilities are important sources of pollutants entering stormwater. Swamikannu (1994) shows how the use of stormwater management practices and pollution protection techniques can decrease the concentration of pollutants present in stormwater runoff from these facilities. An auto recycler facility or scrapyards is one where old and wrecked cars are collected, stripped of their parts, and transported so that metals—and to a lesser extent, plastics, fluids, and other materials—can be recycled. There are more than 20,000 such facilities in the United States, with an average size of 7.4 acres, each processing a mean of 439 vehicles per year.

Auto recycling facilities have the potential to be hotspots of stormwater pollutants for several reasons. First, industry surveys indicate that over two-thirds of the sites store vehicles outside, where they are exposed to rainfall. Second, less than 20% of all facilities drain fluids from vehicles before they are stored. This is critical, as each can contain nearly four gallons of automotive fluids (waste oil, antifreeze, and hydraulic fluid), as well as other pollution sources (filters, tires, and brakes), few of which are reclaimed or recycled (Table 1). Lastly, very few scrapyards are equipped with practices for containing stormwater runoff before it exits the site.

Swamikannu investigated the quality of stormwater runoff at a 17-acre auto recycling facility in Los Angeles, CA, that processes over 16,000 vehicles each year. Composite samples were collected for over 40 storm events for various parameters (Table 2). Clearly, auto recycling facilities do represent a hotspot in the urban landscape, as they typically can have higher concentrations of oil/grease, phenols, BOD, metals, and some priority pollutants compared to other sources (Table 3).

The key question is whether the elevated concentrations are toxic to aquatic life. Swamikannu used bioassays of fathead minnows (*Pimephales promelas*) to test for acute toxicity in stormwater from 49 storm events at the Los Angeles facility. Prior to implementation of stormwater practices at the site, most of the bioassays indicated that runoff was indeed acutely toxic (defined here as 20% or more mortality of the minnows when exposed to stormwater). Statistical analysis suggested that three pollutants were responsible for much of the toxicity: copper, lead, and phenols.

The 10-year monitoring effort allowed Swamikannu to investigate the influence of structural and non-structural practices on controlling stormwater runoff at the site. The primary non-structural stormwater practice involved draining vehicle fluids prior to stripping. An early structural stormwater practice directed wastewater from a dismantling area through a multi-chambered oil-water (OW) separator. During the seventh year of the study additional structural modifications were made to the facility: a roof was constructed over the dismantling area, and the OW storage tank capacity was expanded. Following implementation of the stormwater practices, acute toxicity declined from 100% during the first year of the study to 14% during the final year. In addition, other pollutant concentrations, most notably oil and grease, declined (Figure 1).

A second auto recycler in Riverside County, CA, has implemented even more stormwater practices. Workers drain fluids into storage tanks before dismantling vehicles, and OW separators as well as an aeration-flocculation (AF) treatment system are used. The OW separators collect water from areas used for dismantling, storage, and display. The AF system, consisting of an equalization tank, a coagulating mixer, a settling tank, and an aerator, collects water from the vehicle storage area. Since it is somewhat smaller than the Los

**Table 1: The Anatomy of a Scrapped Vehicle (Swamikannu, 1994)**

Component	Unit	Reclaimed/Recycled
Tires	5	SELDOM
Batteries	1	SELDOM
Antifreeze	1.9 gal.	SELDOM
Waste Oil	0.75 gal.	LESS THAN 40%
Hydraulic Fluid	1.1 gal.	LESS THAN 40%
Filters	4	NO
Brake Pads	1 lb.	NO
Steel	1,620 lbs.	YES
Iron	420 lbs.	YES
Glass	80 lbs.	SELDOM
Plastic	200 lbs.	SELDOM
CFCs	0.5 lbs.	SELDOM

**Table 2: Characteristics of Stormwater Runoff from Auto Recycling Facilities (Swamikannu, 1994)**

Pollutant (unit)	Detection frequency (%) <sup>*</sup>	No. of samples	Median	Mean
TSS <sup>**</sup> (mg/l)	100	50	140	335
BOD <sup>**</sup> (mg/l)	89	42	74	93
TP <sup>**</sup> (mg/l)	90+	58	0.11	23
TN <sup>**</sup> (mg/l)	90+	58	1.58	4.63
O/G (mg/l)	94	44	21	25
Phenols (µg/l)	77	44	30	57
Lead (µg/l)	84	44	111	182
Copper (µg/l)	93	44	90	103
Zinc (µg/l)	95	44	430	520
Cadmium (µg/l)	41	44	5.2	8.3
Chromium (µg/l)	54	44	7	21
Nickel (µg/l)	50	44	30	47
Mercury (µg/l)	12	45	0.09	0.29
Arsenic (µg/l)	49	43	3	5.5

<sup>\*</sup> one-half detection limit substitution method

Note: benzene, ethyl-benzene, toluene, and xylenes also detected in stormwater runoff group samples.

<sup>\*\*</sup> National study of the Auto Recycling Association

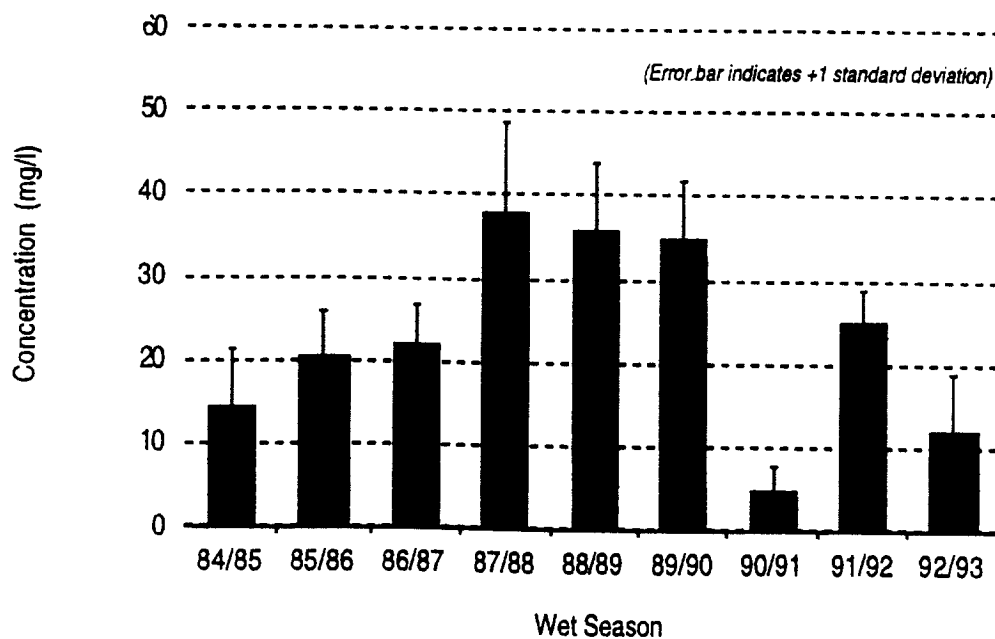
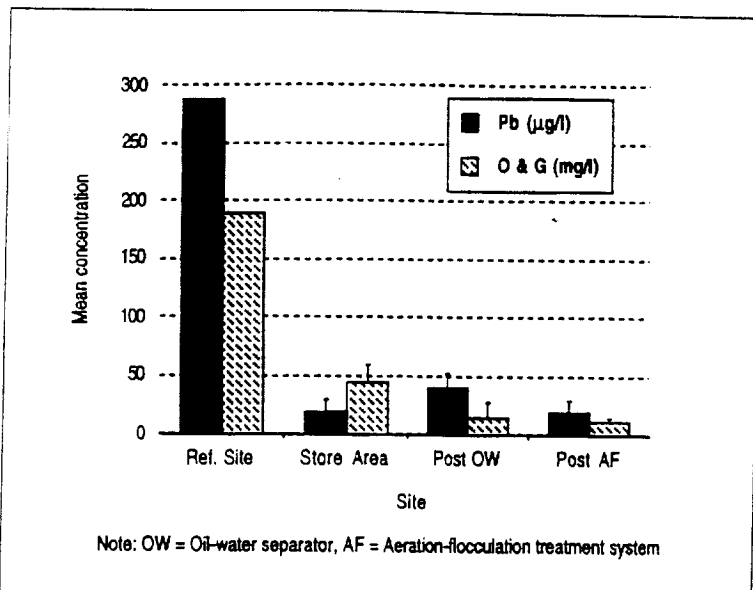

**Figure 1: Trends in the Mean Concentration of Oil and Grease in Stormwater Between 1984 and 1993**



**Table 3: Median Values of Runoff for Selected Sites (Swamikannu, 1994)**

Pollutant (mg/l)	Los Angeles facility	Highway (>30,000 vehicles/day)	NURP runoff
COD	N/A	114	65
Zn	0.430	0.329	0.160
Pb	1.110	0.400	0.140
Cu	0.090	0.054	0.034



**Figure 2: Effect of Treatment on Stormwater Concentrations of Lead (Pb), and Oil and Grease (O&G)**

**Table 4: Examples of Auto Recycling Facility Stormwater Practices (Swamikannu, 1994)**

BMP	Function	Cost/maintenance Considerations
OW separator	Separates oils and grease from water	Maintain regularly
AF treatment	Separates pollutants from water	Expensive; maintain regularly
Sand/gravel filter	Filters pollutants	Replace sand frequently
Detention pond	Settles pollutants	Large space requirement
Vegetative belt	Filters pollutants	Large space requirement
Fluid drainage prior to dismantling	Reduces escape of pollutants	Inexpensive
Cover dismantling area	Reduces vehicle exposure	Inexpensive; low maintenance
Berm around dismantling area	Reduces flow across dismantling area	Inexpensive; low maintenance

Angeles facility (13 acres; in 1991 it processed a mean of 10,000 vehicles/year), the Riverside County facility was compared to a reference site of similar size and processing magnitude. This reference facility is located in Sacramento County, CA, and practices no stormwater treatment measures other than removing fluids prior to dismantling. After undergoing AF treatment, effluent concentrations of oil/grease and lead declined considerably to levels approaching the US Environmental Protection Agency (EPA) benchmark (Figure 2). This observation shows the effectiveness of multiple stormwater treatment systems.

Swamikannu's study shows that the selection of appropriate stormwater practices can make a significant difference in pollutant loads. In addition to the practices used in the test facilities he recommends several others (Table 4). Each can help improve stormwater quality, but draining fluids prior to dismantling, covering the dismantling area, and building a berm are the most inexpensive and maintenance-free approaches.

Still, additional studies are needed to further quantify the relative effectiveness of different stormwater practices. There are currently two types of auto recycler facilities: self-service (where customers take what they need) and service-counter (where employees remove the parts). Pollution prevention education targeted to both facility types is necessary. Programs designed for service stations can serve as models.

—GRR

**References**

Swamikannu, X. 1994. *Auto Recycler Facilities: Environmental Analysis of the Industry With a Focus on Stormwater Pollution*. Ph.D. Diss. University of California, Los Angeles.

# Watershed Monitoring

R0080143

MISSISSIPPI



# An Introduction to Stormwater Indicators

**M**unicipal officials are increasingly asked to protect threatened water resources in the face of urban growth pressures. While municipalities, industries, and governments have all developed technologies to treat human sewage and industrial wastes (i.e., point source discharges), and have developed scientifically accepted methods to monitor the success of these treatment strategies, the ability to successfully treat urban stormwater and measure the effectiveness of these treatments is still several levels below the "point source control" field.

The reasons appear to be relatively simple to explain, yet hard to quantify. Sewage treatment plant outfalls and industrial site discharges generally come from one location or source and therefore the chemical makeup of the outfall is reasonably easy to identify. Numerical limits for pollutant concentrations are relatively easy to establish (at least for dry weather conditions) and, in theory, are reasonably easy to enforce. On the other hand, pollutants in stormwater runoff are likely to come from many very small source areas that are often hard to pinpoint. Furthermore, stormwater runoff varies widely as a function of rainfall intensity and duration. Therefore, pollutant concentrations are likely to differ spatially along a given waterbody due to varying dilutions as mixing occurs from other drainage areas. Finally, stormwater runoff events are often very short-lived, particularly in urban streams. These episodes are often highly variable with large inputs of runoff and pollutants occurring and dissipating in a few hours.

Until recently, most stormwater monitoring was conducted at pipe outfalls along the urban drainage system. The data gleaned from these investigations have helped us to characterize the concentrations of untreated urban runoff. For example, the National Urban Runoff Program (NURP) studies, conducted by the Environmental Protection Agency (EPA) and others in the early 1980s, helped establish a database that has proved useful in computing stormwater loadings of pollutants from various land uses. More recently, National Pollutant Discharge Elimination System (NPDES) monitoring data from municipal and industrial stormwater permits have helped confirm the earlier NURP data, as well as confirm particular pollutant source increases or decreases over time (e.g., reductions in lead due to discontinuation of leaded gasoline in automobiles). An example of typical stormwater runoff concentrations is shown in Table 1.

Stormwater pollutant concentration data have been used frequently to assess compliance with water quality standards and criteria. Examples of specific criteria include limits on maximum concentrations for either human ingestion or aquatic life exposure. These criteria were developed by the EPA (1983) in an attempt to define the effects of short term and intermittent exposures typically associated with urban runoff. Problems with relying on water quality criteria include:

- An exceedance of a numerical limit in a receiving waters may occur for only a short period of time during or immediately after a storm
- An exceedance at an outfall does not necessarily mean that water quality criteria have been exceeded in a stream because of dilution
- There is a considerable scientific uncertainty about exact species effects and lethality for a given pollutant concentration
- Human ingestion limits may not appropriately reflect the aquatic life uses of the receiving waters

Consequently, it has been difficult for municipal officials and regulators to relate stormwater pollutant concentration data to evaluate the effectiveness of stormwater management practices. Furthermore, pollutant concentrations are generally similar from location to location. In fact, with the exception of a few isolated urban "hotspots," there is surprisingly little difference among recent stormwater chemistry monitoring studies.

More recently, biological monitoring methods have been used to help evaluate the cumulative effects of stormwater runoff on receiving waters. In at least one aspect, biological monitoring is perhaps a more reliable indicator than chemical monitoring, since biological communities can accumulate the effects associated with continual exposure to both stormwater and low flow events. Dr. Robert Karr, one of the preeminent scientists in the field of bioassessment, found that the health of fish communities in mid-western U.S. streams was directly related to the degree of human influence on watersheds (Karr, 1986).

While the use of biological monitoring methods is not new, it is only within the last few years that they have been applied to directly assess the impacts of urban

**Table 1: Typical Stormwater Outfall Mean Concentrations for Several Source Areas—Arithmetic Means for the Source Area (Wisconsin, 1992)**

Source Area	Susp. Solids (mg/L)	Total Phos. (mg/L)	Diss. Phos. (mg/L)	Total Cd (µg/L)	Total Cr (µg/L)	Total Cu (µg/L)	Total Pb (µg/L)	Total Zinc (µg/L)
Industrial roof	54	0.13	0.02	0.3	—	7	8	1348
Arterial street	875	1.01	0.25	2.8	26	85	85	629
Feeder street	969	1.57	0.62	3.7	17	97	107	574
Parking lot	474	0.48	0.07	1.2	16	47	62	361
Residential driveway	193	1.50	0.87	0.5	2	20	20	113
Flatroof	19	0.24	0.11	0.4	—	10	10	363
Collector street	386	1.22	0.36	1.7	13	61	62	357
Arterial street	241	0.53	0.14	2.6	18	50	55	554
Parking lot	91	0.26	0.07	0.8	7	21	30	249
Residential lawn	457	3.47	2.40	—	—	13	—	60
Residential roof	36	0.19	0.08	0.2	—	5	10	153
Feeder street	1085	1.77	0.55	0.8	7	25	38	245
Outfall	374	0.86	0.34	0.6	5	20	40	254

Note: Dash indicates insufficient sample size.

stormwater runoff.

#### Environmental Indicators—Stormwater Monitoring Tools

The Center has recently completed an investigation on the use of monitoring methods to evaluate municipal and industrial stormwater programs and practices. The research focused on the use of *environmental indicators* as tools for monitoring urban stormwater runoff. Environmental indicators are direct or indirect measures that indicate trends or responses in receiving waters. Environmental indicators can be used to characterize overall or specific conditions in receiving waters and can help provide a benchmark for assessing the success of stormwater management strategies. For instance, indicators can be broadly based, as in measurements of global changes in species extinction rates, or very specific, as in the loss of a sensitive stonefly species in a headwater stream system.

In one sense, environmental indicators can be viewed as economic indicators, such as housing starts, or growth in GNP, which are direct measures of economic activity and are used to assess the health of the overall economy. Similarly, environmental indicators may be able to provide assessments of improvements (or downturns) in the watershed and measure the effectiveness of watershed management strategies.

Environmental indicators cover a wide array of monitoring parameters applicable to a variety of envi-

ronmental settings and management concerns (i.e., water supply, point sources, forests, wetlands, or groundwater). **Stormwater indicators** apply to a subset of environmental indicators that specifically address urban stormwater runoff impacts and the evaluation of stormwater programs and practices. Stormwater indicators are designed for use by municipal stormwater managers, regulatory agencies, or industrial site managers to assess the effectiveness of specific management strategies.

Research was conducted on a total of 26 stormwater indicators which were grouped into six broad categories. Each category (identified in Table 2) represents a distinct area of stormwater monitoring and/or assessment. Several of the topics will be familiar to many stormwater practitioners, while a few, such as social and programmatic indicators, may represent new approaches to evaluating stormwater program effectiveness. An important element to consider is the linkage between what is done on the land, how it is regulated or evaluated, and the corresponding effects to the receiving waters or environment.

Table 2 identifies the principal area of utility for the six indicator categories.

*Water quality* indicators are more traditional monitoring methods, familiar to most stormwater management officials. While these monitoring techniques may not be new by themselves, they are still very useful for specific applications, particularly where pollutant source

and identification are sought. Water quality indicators are perhaps best utilized when other, less costly indicators have already identified a problem, or where a legal dispute necessitates the identification of a particular pollutant or group of pollutants.

*Physical/hydrological* indicators measure changes to the physical environment associated with changing conditions, such as changes in stream channel geometry or bottom sediment composition resulting from increased frequency of erosive stormflows. These indicators are generally less expensive to conduct, but may often need to be combined with other indicators to tell the full story.

*Biological indicators* are useful for gaging the cumulative effects of urban runoff, since biological communities are continually exposed to the intermittent and widely varied effects of urban runoff flows and pollution pulses. Different techniques are more aptly suited to assess long-term versus short-term impacts. This group of indicators is already reshaping many monitoring programs across the county, and promises to continue to provide meaningful results at a fraction of the cost of more traditional water chemistry monitoring methods.

*Social indicators* are more aptly suited to gaging responses of the public to water resource conditions. These indicators assess public opinion, political will and industry willingness to implement, maintain, or expand stormwater management programs.

*Programmatic indicators* are mainly utilized by municipal, state, and federal officials to gage program

success through results from quantitative analyses of program initiatives, such as the number of permits issued or inspections conducted for a given program element. Programmatic indicators do not provide specific measurements of waterbody health, but can provide valuable information about potential impacts or program effectiveness.

*Site indicators* are specifically adapted to measuring conditions at the site level. Only two individual indicators were singled out as assessment tools at this level; stormwater practices performance monitoring; and industrial site compliance monitoring. Others are certainly adaptable to the on-site assessment level, but are described more in the context of watershed-wide investigations. Table 3 identifies 26 indicators.

#### Framework for Using Indicators

The Center's research observed that many practitioners are already applying stormwater indicators in monitoring local and state programs. As part of our efforts, the Center compiled an annotated bibliography of environmental indicators. The bibliography contains approximately 500 citations of studies involving environmental indicators in the last 15 years, primarily in the urban stormwater arena.

While reviewing and compiling the bibliography, we observed several common elements which suggest that the identification and selection of appropriate indicators for monitoring programs should be conducted within an established framework. This framework focuses on the relationship between urbanization and impacts on water resource quality by presenting the

Table 2: Categories of Environmental Indicators Used for Stormwater Assessment

Indicator Category	Description	Linkage element being assessed
Water Quality	Group of indicators used to measure specific water quality or chemistry parameters	Receiving water resource quality
Physical/ Hydrological	Group of indicators used to measure changes to, or impacts on the physical environment	Receiving water resource quality
Biological	Indicators which use biological communities to measure changes to, or impacts on biological parameters	Receiving water resource quality
Social	Group of indicators which use responses to surveys or questionnaires to assess various parameters	Human activity on the land surface (stressor)
Programmatic	Indicators which quantify various non-aquatic parameters for measuring program activities	Regulatory compliance
Site	Indicators adapted for assessing specific conditions at the site level	Human activity on the land surface (stressor)

importance of reference conditions, reinforcing the concept of eco-regions and regional considerations, and describing tools common to many different indicators.

*Reference conditions* are used to establish a benchmark for assessing existing conditions or to measure trends in conditions. Reference sites should be selected to represent least or minimally-impacted conditions within the same physiographic region as the water body being evaluated. Eco-regions, representing regions of similar land form, soils, climate, natural vegetation, and general land use, should also be utilized in the establishment of reference sites.

Regional geography also provides a framework for the selection of indicators. Several stormwater indicators require regional adaptation to be utilized in different regions of the county. For example, Miller and others reported that the Index of Biotic Integrity (the protocol for evaluating fish communities developed by Karr and others) can be modified in various regions to reflect local native species, thus providing an indicator of greater utility and applicability (Miller *et al.*, 1988).

Several "tools" can be utilized over a broad range of physical, chemical, and biological conditions to measure environmental indicators (Table 4). Geographic Information Systems (GIS) and watershed simulation modeling tools are used to estimate watershed variables, such as land use/land cover; analyze different development scenarios; calculate the potential pollutant load wash-off and/or assess stormwater runoff quantities; and identify locations and conditions of biological and physical parameters.

The paired watershed monitoring protocol compares the response of two watersheds, with a documented relationship, when subjected to different management strategies and/or development patterns. One watershed usually serves as the control, where no changes occur, while the other watershed receives some kind of treatment. This approach allows monitoring studies to be conducted reasonably quickly and permits the presentation of more timely results. Paired watershed studies have the advantage of accounting for climatic or hydrologic anomalies (i.e., floods or droughts), but usually require more resources in terms

Table 3: Full List of Stormwater Indicators

Indicator Type	Indicator Name	Number
Water Quality Indicators	Water quality pollutant constituent monitoring	1
	Toxicity testing	2
	Non-point source loadings	3
	Exceedance frequencies of water quality standards	4
	Sediment contamination	5
	Human health criteria	6
Physical and Hydrological Indicators	Stream widening/downcutting	7
	Physical habitat monitoring	8
	Impacted dry weather flows	9
	Increased flooding frequency	10
	Stream temperature monitoring	11
Biological Indicators	Fish assemblage	12
	Macro-invertebrate assemblage	13
	Single species indicator	14
	Composite indicators (e.g., IBI)	15
	Other biological indicators (e.g., mussels)	16
Social Indicators	Public attitude surveys	17
	Industrial/commercial pollution prevention	18
	Public involvement and monitoring	19
	User perception	20
Programmatic Indicators	No. of illicit connections identified/corrected	21
	No. of practices installed, inspected, and maintained	22
	Permitting and compliance	23
	Growth and development metrics	24
Site Indicators	BMP performance monitoring	25
	Industrial site compliance monitoring	26

of money and staff, since at least two sets of measurements must be collected. These studies also require extensive documentation of existing conditions as well as during the period of evaluation.

Photographs provide a revealing record of conditions at a given time. They are easy to do, require little special training, are inexpensive, and are easily understood by a wide audience. This tool is particularly useful for documenting changing physical conditions over time.

#### Cost of Indicators

Perhaps the most frequent question asked by program managers in implementing a monitoring effort is: how much will it cost? As part of our research, we compiled comparative cost information on different stormwater indicators. Representative indicator cost data is presented in Table 5, and the full dataset is available in Claytor and Brown (1996).

The unit cost data is presented on a per station, per sampling event basis wherever possible. It should be noted that the monitoring protocol for a given indicator may require a unique combination of stations and/or samples to provide reliable data. Where possible, the cost data represents the most prevalent monitoring methodology being utilized around the country. Managers should recognize that the range of indicators often require sampling at different frequencies, densities, and for different parameters and therefore a direct comparison of unit costs can be misleading. As with all cost data, these numbers should be verified with different sources, before planning and implementing program monitoring strategies.

#### A Methodology for Utilizing Stormwater Indicators

Many watershed managers still prefer a simple "cookbook" methodology to assist in implementing their monitoring program. A methodology can also help bring consistency and common sense to successful programs. Historically, many stormwater monitoring programs were often regulatory-driven and focused almost exclusively on water chemistry monitoring. While this data often helped establish baseline conditions, monitoring results were generally not well suited for assessing overall stormwater management program success.

What appears to be clear is that individual indicators have distinct roles in assessing different aspects of programs and practices. Some are more appropriate for identification of problems, while others are more aptly suited to assess program effectiveness. Even the individual indicators have different level-of-effort methodologies to answer different questions. For example, macro-invertebrate monitoring may be conducted qualitatively to answer the question of whether a stream is impacted from human activity. To assess the causes

Table 4: Tools for Indicator Use

Tool	Application Example
Watershed Simulation Modeling	Estimate pollutant load export
Geographic Information Systems	Estimate impervious area changes
Paired Subwatershed Monitoring	Compare flow volume and pollutant loads between two watersheds
Comparison to Reference Conditions	Compare macroinvertebrate diversity between an urban stream and a rural stream
Photographic Record	Qualitatively measure physical erosion for a stream over time

and possible sources of those impacts, however, a much more quantitative analysis is often needed including chemical and physical monitoring (Plafkin *et al.*, 1989).

A simple, two-phase methodology for utilizing indicators is presented in Figure 1. Level 1 is targeted at municipalities and industrial sites with limited or no data available to characterize baseline conditions, and is intended to help locate and identify problems caused by urban stormwater runoff. Level 2 is geared more towards those locations which already understand their water quality problems and are interested in assessing how well their management programs are addressing those problems. The methodology is intended to be a flexible, dynamic tool for stormwater managers. There are no mandates to begin at a given step or level. Instead, managers are encouraged to utilize whatever component most accurately represents their respective monitoring needs.

#### Summary

Past urban stormwater runoff monitoring has tended to be more oriented towards the end-of-pipe, water chemistry mindset. In order to fully assess the impacts of urbanization and industrial site runoff, a shift is necessary that focuses more attention on monitoring the receiving water quality and the uses of those receiving waters. Stormwater indicators provide a suite of opportunities to assess different aspects of a stormwater management program, measure the stressors associated with human activity on the land surface, and establish the conditions of aquatic communities in the receiving waters. The various costs, framework, and methodology for using indicators give managers the ability to implement a monitoring program appropriate for their individual water resource protection and/or restoration goals. Given the proper regulatory environment, which incorporates flexibility and emphasizes



Table 5: Representative Unit Cost Data for Selected Stormwater Indicators

Indicator No.	Indicator/Basis for Cost	Implementation Cost	Notes
(1)	<p><b>Water quality constituent pollutant monitoring</b></p> <ul style="list-style-type: none"> <li>Per site, one person at each site</li> <li>Sampling site accessible from land</li> <li>Conventional pollutants and physical parameters <i>(Those typically identified as pollutants of "concern" in urban runoff)</i></li> <li>Four hour sampling event</li> <li>Single composited sample provided for lab. analysis</li> <li>Weir/Flume used for stage-discharge relationship</li> <li>Grab samples collected manually</li> <li>Composite aliquots collected with automated sampler</li> <li>Compositing based on constant time-volume proportional to flow increment relationship</li> </ul>	\$675 - \$825 per station, per event	Cost to set-up station (installation and calibration of weir or flume; development of stage discharge relationship; acquisition of automated samplers and DO, temperature, conductivity, and pH equipment; acquisition of reagents, sampling jars, etc.) not included. Set up costs (based on the above assumptions) will average between \$4,000 - \$10,000 per station. Cost may be reduced by using same sampler at different stations during different storm events and/or by using alternative methods to determine flow.
(7)	<p><b>Stream widening/downcutting</b></p> <ul style="list-style-type: none"> <li>Per reach cost</li> <li>Reach defined as approximately 2,000', 10 measurements per reach</li> <li>Two staff members required per site</li> <li>Stream cross-sections measured with taped surveys</li> <li>Field cross-sections established and recorded with flagged steel reinforcing bar</li> <li>Includes overhead expenses (supplies, vehicles, travel, utilities, maintenance, rent, printing, etc.)</li> <li>Includes data analysis and preparation of summary report</li> </ul>	\$575 - \$700 per 2,000' reach	Cost is based on surveying first and second order headwater streams in semi-humid to humid climates.  For start-up costs, add:  Steel reinforcing bars, flagging, hip chain, 50' tape, wading rod, notebooks, clinometer, and computer(s).
(13)	<p><b>Macro-invertebrate assemblage</b></p> <ul style="list-style-type: none"> <li>Per sample, per site cost</li> <li>Two staff members required per site</li> <li>Includes overhead expenses (supplies, vehicles, travel, utilities, maintenance, rent, printing, etc.)</li> <li>Includes data analysis and preparation of summary report</li> </ul>	\$500 - \$625 per sample, per site	Cost is based on RBP protocol III (Plafkin, et al. 1989)m and sampling to genus level.  For start-up costs, add:  Microscope, kick-screen sampler(s), glass-ware, preservative, and computer(s)
(17)	<p><b>Public Attitude Surveys</b></p> <ul style="list-style-type: none"> <li>Per survey cost per 1,000 households contacted</li> <li>Interviews conducted over telephone</li> <li>Includes survey implementation, data analysis, and preparation of summary report</li> </ul>	\$14,500 - \$17,750 per 1,000 households	Generally, 50% of those households contacted respond to survey.
(21)	<p><b>No. of Illicit Connections Identified/Corrected</b></p> <ul style="list-style-type: none"> <li>Per illicit connection identification survey</li> <li>Assumes survey will be conducted visually (i.e., smoke, dye, or other methods will not be used)</li> <li>Illicitness of dry-weather flows will be determined by tracing source upstream in system and through use of field test kits</li> </ul>	\$1,250 - \$1,750 per square mile	Cost estimate does not include cost associated with correction of illicit connections.
(26)	<p><b>Industrial Site Compliance Monitoring</b></p> <ul style="list-style-type: none"> <li>Per industrial site (based on 5 acre site)</li> <li>Light-industrial land use</li> <li>Visual inspections of compliance with pollution prevention plans</li> <li>One technical inspector per site</li> <li>Includes overhead expenses (supplies, vehicles, travel, utilities, maintenance, rent, printing, etc.)</li> <li>Includes data analysis and prep. of summary report</li> </ul>	\$290 - \$350 per 5 acre site	Cost estimate based on visual inspections only.  For start-up costs add:  Notepads, computer(s), camera.

education and voluntary actions as key components of monitoring efforts, stormwater indicators should become major elements of municipal and industrial site monitoring and management assessment programs.

-RAC

#### References

- Bannerman, R.T., D.W. Owens, R. Dodds, and P. Hughes. 1992. *Sources of Pollutants in Wisconsin Stormwater*. WI Dept. of Natural Resources, Madison, WI.
- Clayton, R. and W. Brown. 1996. *Environmental Indicators to Assess the Effectiveness of Municipal and Industrial Stormwater Control Programs*. Final Report. Center for Watershed Protection. US EPA Office of Wastewater Management. Silver Spring, MD. 210 pp.
- Karr, J.R., K.D. Fausch, P.L. Angermeier, P.R. Yand, and I.J. Schlosser. 1986. *Assessing Biological Integrity in Running Waters: A Method and its Rationale*. Illinois Natural History Survey Special Publications 5.
- Miller, D.L., P.M. Leonard, R.M. Hughes, J.R. Karr, and P.B. Moyle. 1988. *Regional Applications of an Index of Biotic Integrity for Use in Water Resource Management*. Fisheries. Volume 13, No. 5. September-October 1988. pp. 12-20.
- Plafkin, J.L., M.T. Barbour, K.D. Porter, S.K. Gross, and R.M. Hughes. 1989. *Rapid Bioassessment Protocols for Use in Streams and Rivers: Benthic and Fish*. Environmental Protection Agency, Office of Water. Washington, DC. EPA/440/4-39-001.
- Schueler, T. 1987. *Controlling Urban Runoff: A Practical Manual for Planning and Designing Urban BMPs*. Metropolitan Washington Council of Governments, Washington, DC. pp. 275.
- U.S. Environmental Protection Agency (EPA). 1983. *Results of the Nationwide Urban Runoff Program. Vol. I. Final Report*. Water Planning Division.

Level 1 Problem Identification	Level 2 Assessment of Management Program
<p><b>1. Establish management sphere</b> <i>Who will be responsible for implementation? What other programs are being implemented within watershed?</i></p> <p><b>2. Gather/review historical data</b> <i>Identify programs /studies already implemented in the watershed. Determine problem areas and assess effectiveness of earlier efforts.</i></p> <p><b>3. Identify potential receiving water impacts</b> <i>Identify uses/characteristics which may be impacted by stormwater runoff.</i></p> <ul style="list-style-type: none"> <li>• Hydrology and hydrodynamics (flooding, drainage, physical habitat)</li> <li>• Biological integrity (fish diversity, macro. community)</li> <li>• Non-contact recreation (sports fishing)</li> <li>• Supply (potable water)</li> <li>• Contact recreation (swimming)</li> <li>• Aqua-culture (shellfish harvesting, food fishing)</li> </ul> <p><b>4. Inventory resources and identify constraints</b> <i>Determine staff and funding limitations. Identify regulatory-mandated deadlines and programs.</i></p> <ul style="list-style-type: none"> <li>• Scheduling Constraints</li> <li>• Funding</li> <li>• Regulatory Compliance</li> </ul> <p><b>5. Assess baseline conditions</b> <i>Use rapid (qualitative) assessment methods versus detailed quantitative techniques to assess baseline conditions.</i></p> <p><b>Indicator Options by Receiving Water Use</b></p> <ul style="list-style-type: none"> <li>• Hydrology and hydrodynamics <i>Physical / Social / Programmatic / Site</i></li> <li>• Biological integrity <i>Biological / Water quality / Social / Programmatic / Site</i></li> <li>• Non-contact Recreation <i>Water quality / Physical / Biological / Social / Programmatic / Site</i></li> <li>• Water Supply <i>Water quality / Biological / Social / Programmatic / Site</i></li> <li>• Contact Recreation <i>Biological / Water quality / Physical / Social / Programmatic / Site</i></li> <li>• Aquaculture <i>Biological / Water quality / Physical / Social / Programmatic / Site</i></li> </ul>	<p><b>1. State goals for program</b> <i>Based on baseline conditions, resources, and constraints, articulate goals for stormwater management program in terms of measurable achievements.</i></p> <p><b>2. Inventory prior and ongoing efforts</b> <i>Identify prior stormwater management efforts and assess success of prior efforts. Identify current stormwater management efforts and assess success of ongoing efforts. Incorporate complementary programs and goals. Identify potential conflicts.</i></p> <p><b>3. Develop and implement management program</b> <i>Identify and implement specific program facets in order to achieve goal.</i></p> <p><b>4. Develop and implement monitoring program</b> <i>Based on goals, program structure, resources and constraints, select indicators to be used to assess success of stormwater management program. Level II indicators will likely be more quantitative in comparison to Level I techniques.</i></p> <p><b>5. Assess indicator results</b> <i>Analyze indicator monitoring results.</i></p> <ul style="list-style-type: none"> <li>• What do the monitoring results indicate about the success of the stormwater management program?</li> <li>• Have the indicators accurately reflected the effectiveness of the management program?</li> <li>• What do indicators suggest about the ability of the stormwater indicator monitoring program to measure of overall watershed health?</li> </ul> <p><b>6. Re-evaluate management program</b> <i>Re-evaluate resources and constraints. Update (if necessary) assessment of baseline conditions. Review and revise program goals. Review and revise management program. Review and revise indicator monitoring program.</i></p>

Figure 1: A Methodology for a Stormwater Indicator Monitoring Program (Claytor and Brown, 1996)

# Stream Restoration

R0080153



# Assessing the Potential for Urban Watershed Restoration

**A**fter many years of neglect and abuse, urban streams and rivers have recently become the focus of restoration efforts throughout many parts of the country. For example, Barth *et al.* (1994) identified over 50 urban watershed programs that have been organized in the last few years. Communities increasingly recognize the value of healthy aquatic systems within urban areas and are taking steps to improve the quality of degraded streams. The motivating factors underlying each program vary. For some, the goal is to improve water quality to receiving waters. In others, the objective is to enhance the urban environment and provide recreational areas. Others seek to recover aquatic diversity within urban streams. These emerging urban watershed restoration efforts are unique in that they target stormwater treatment and habitat enhancement to rehabilitate urban streams.

While many communities now share the goal of urban watershed restoration, they may not always be sure how to go about it, or whether it is really an achievable goal. This article summarizes some of the experience of the last five years in the Mid-Atlantic region. We present a detailed method to assess and identify restoration opportunities and analyze, at the subwatershed scale, whether restoration is possible.

## Watershed Restoration Feasibility

Before spending millions of dollars and countless hours of staff time, watershed managers must ask a simple question: *Can the watershed really be restored?* We can always do some things to improve water quality to the receiving waters or enhance stream corridor aesthetics, but we must also realize that certain constraints exist within the urban environment that may make complete restoration extremely difficult, if not impossible.

For example, in the ultra-urban setting, where impervious cover exceeds 60 to 70%, most streams may have been previously piped. These areas are going to be next to impossible to restore. Other key criteria that must be considered are identified in Table 1. Although a negative response to a single criteria probably will not make restoration infeasible, a negative response to several criteria may well signal that watershed restoration is not feasible.

In our view, there are essentially three types of urban stream restoration possible. The first is a watershed where it is feasible to at least partially restore a native biological community within the stream. The second is a watershed that acts primarily as a conduit for stormwater runoff, where it is only possible to reduce pollutants to the receiving water body, and few opportunities exist to restore the stream. The third is a watershed where both pollutant load reductions and stream restoration are not feasible, and restoration is limited to stream corridor management. This article presents a restoration process for the first type of system. For those areas where meaningful stream restoration is not attainable, some of the following process may still be useful.

Before discussing a watershed restoration process, it is useful to establish the concept of watershed scale (Figure 1). An urban watershed may be several square miles in area and consist of several major stream systems. A subwatershed usually encompasses first or second order tributaries to the main stream and has a drainage area of approximately 1,000 to 1,500 acres (this can vary depending on regional differences). A subwatershed then consists of several catchments, which usually have drainage areas between 50 and 500 acres.

Meaningful watershed restoration must be conducted at the subwatershed scale for several reasons. First, not all subwatersheds within an urban watershed will have the same level of impervious cover, and therefore impacts and restoration opportunities often

**Table 1: Subwatershed Restoration Screening Criteria: Is Restoration Feasible?**

- Are stream valley parks present within the subwatershed?
- Is there available public or military land?
- Are the streams and waterways open channels?
- Is prior biological data available for the stream?
- Does the local government have a small-scale GIS database of watershed information?
- Does the subwatershed have a moderate impervious cover (i.e., less than 60%)?
- Does the local government have a stream buffer program?
- Have stormwater detention structures been historically installed in the subwatershed?
- Are there existing floodways within the subwatershed?

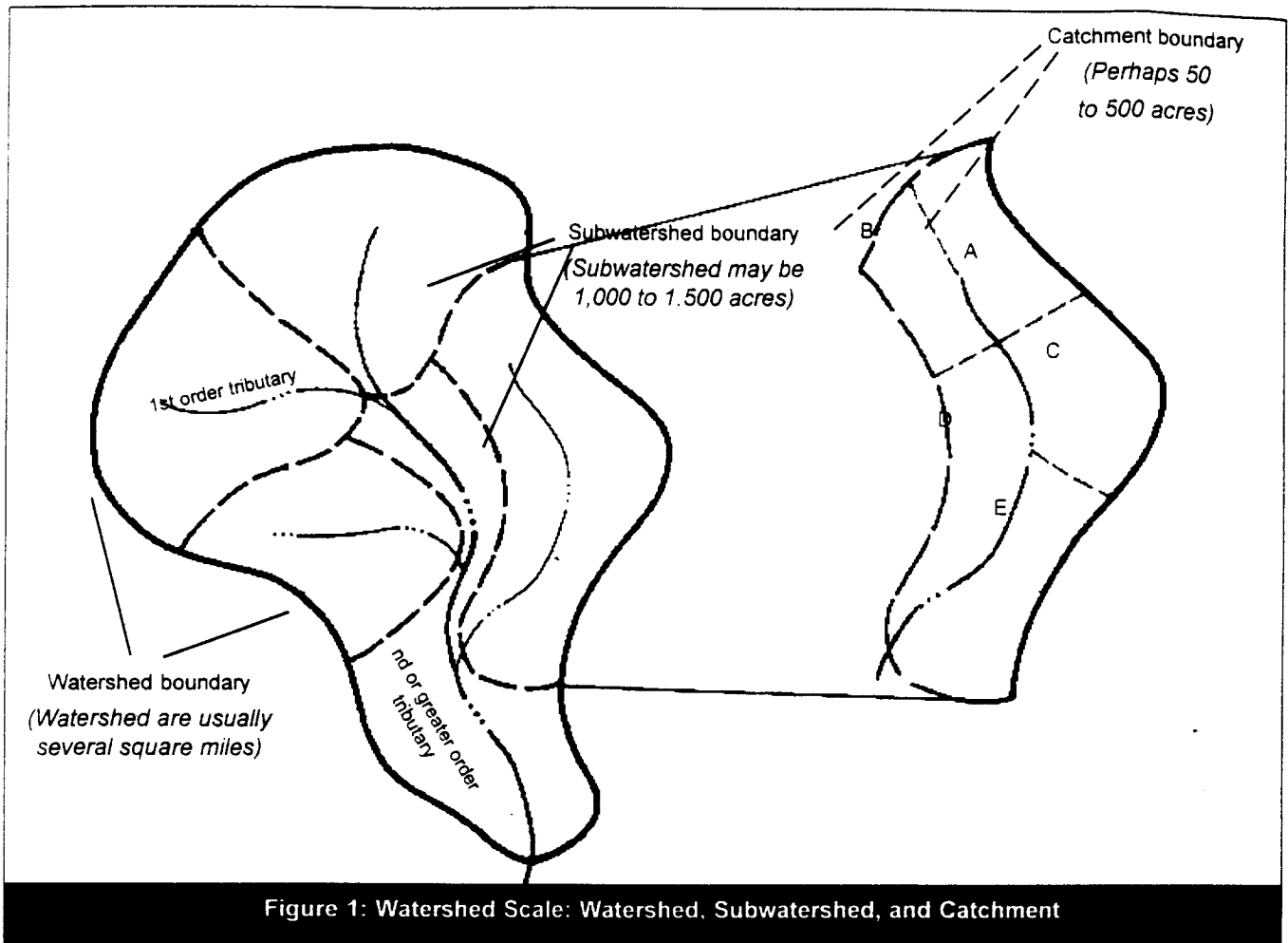

Figure 1: Watershed Scale: Watershed, Subwatershed, and Catchment

differ between subwatersheds. Second, it is easier to identify structural restoration sites and other opportunities at the subwatershed level. Third, local neighborhoods often fall within the scale of the subwatershed, making it easier to target pollution prevention efforts. Finally, and perhaps most importantly, the subwatershed scale is small enough to accurately measure the percentage of subwatershed area that can be treated by stormwater retrofits. We refer to this as the “control area.” This concept is extremely important when choosing priority subwatersheds for restoration.

Watershed restoration usually takes decades to implement, whereas subwatershed efforts can be accomplished in shorter time periods. Some subwatersheds may receive stream restoration, while others may receive only corridor management measures. Therefore, by concentrating on one subwatershed at a time, we can measure improvement to that aquatic system while still contributing improvements to the watershed as a whole.

Watershed managers should keep several principles in mind when embarking on a watershed restora-

tion effort. First, urban watershed restoration is primarily a question of what is possible. When striving to restore basic ecological functions to the aquatic environment, watershed managers need to look at current and past land use and stream quality to set realistic and achievable goals for the future. Another prerequisite is to establish a partnership approach. Many different agencies, organizations, and professionals will need to coordinate together to implement projects. A successful restoration plan will require strong fiscal and staff commitments. Some past efforts have failed because inadequate resources were available to complete the effort. Watershed restoration can also involve substantial change within the community. A strong educational program that involves local residents early in the restoration process can help explain the purpose of projects and provide support for the most intrusive changes.

#### Urban Watershed Restoration Process

The following process identifies a three-pronged approach to watershed restoration through stormwater retrofitting, pollution prevention, and stream en-

**hancement.** This process is recommended to achieve realistic improvements in aquatic communities for urban streams within the subwatershed context. Table 2 highlights the major components of the watershed restoration process.

The restoration process begins with an analysis of existing stream channel and subwatershed conditions. Several alternative stream assessment techniques are available to evaluate existing conditions. Stream characterization studies that identify biological communities such as macroinvertebrates or fish may be conducted. Land use assessments that measure impervious cover or percent industrial/commercial land may also be appropriate. Chemical water quality monitoring data may be collected or physical stream geometry parameters may be studied. The more detailed the assessment, the more useful it will be in developing a restoration plan. However, since most programs have limited money, an assessment that quickly provides information and identifies problem areas is most practical. A review of any past monitoring data (physical, chemical and biological) coupled with a rapid watershed wide monitoring protocol, such as the Rapid Stream Assessment Technique (RSAT) (Galli, 1993) is an ideal tool for documenting existing conditions and identifying problem areas.

#### Urban Watershed Retrofit Process

Once an analysis of existing conditions has been completed, a structural retrofit inventory is conducted. This process involves identifying subwatersheds, locating candidate retrofit sites and determining how much area within the subwatersheds can be controlled.

##### 1. Desktop Survey of Potential Candidate Stormwater Practice Sites

The first step of the process consists of identifying candidate retrofit sites through a desktop survey. To begin, the watershed is subdivided into subwatersheds that range from 1,000 to 1,500 acres in size. This unit forms the fundamental basis for further restoration analysis. Subwatersheds, in turn, are subdivided into individual catchments ranging from 50 to 500 acres in size. Once these drainage units are mapped, low altitude color areal photographs are used to locate potential retrofit sites. Several additional mapping sources are also needed to select candidate sites, including the following:

- Topography (usually at a scale of 1"=200' or finer)
- Impervious cover based on land use/zoning maps
- Property ownership (usually available through tax maps)
- Open space parcels (using a recent aerial photograph and land use maps)
- Existing drainage network (including storm drainage pipes and open channels)

The best potential retrofit sites are usually located adjacent to existing engineered or natural channels, at the outfall of a storm drainage pipe or within an existing older stormwater management facility. Undeveloped parkland and open space areas, golf courses, wide floodplains, highway rights-of-way, and parking lot edges are also good places to look (see article 143 for more information on the details of stormwater retrofitting).

Good potential retrofit sites generally have the following characteristics:

- Within an existing open area (not forested and not occupied by existing structures)
- Has sufficient runoff storage capacity for the tributary catchment
- Feasible to divert stormwater to potential facility
- The site should have a drainage area large enough to make a meaningful contribution to the water quality of the catchment

##### 2. Comprehensive Field Survey of Candidate Stormwater Practice Sites

Candidate retrofit sites meeting the desktop criteria are then field verified using a retrofit inventory sheet (RIS). The RIS includes site-specific information on location, ownership, approximate drainage area, utility locations, etc. An appropriate stormwater retrofit to meet the site specific constraints is identified in the field.

Table 2: Watershed Restoration Process

- Create intergovernmental/partnership agreements where necessary
- Conduct watershed assessment
  - Monitoring
  - Mapping
  - Stream reconnaissance
- Perform subwatershed delineations
- Characterize subwatershed conditions
- Evaluate candidate retrofit opportunities
- Conduct informational workshops and review retrofit opportunities with resident groups
- Assess stream restoration opportunities
- Assemble restoration opportunities into inventory
- Perform pollution prevention opportunity surveys
- Select priority subwatershed for demonstration projects
- Rank individual projects
- Develop comprehensive watershed/subwatershed plan
- Incorporate public involvement and active participation
- Initiate project implementation
- Evaluate restoration efforts



**Table 3: Sample Retrofit Scoring System**

Description	Score
<b>Pollutant Load Reduction (1 - 10 points)</b>	
<u>Storage</u>	
0.00 - 0.25 ac-ft	1 pt
0.26 - 1.00 ac-ft	2 pt
1.01 - 2.00 ac-ft	3 pt
2.01 - 4.00 ac-ft	4 pt
4.01 or more	5 pt
<u>Pollutant Load Reduction (1 - 10 points)</u>	
0% - 10%	1 pt
11% - 30%	2 pt
31% - 40%	3 pt
41% - 50%	4 pt
51% or more	5 pt
<b>Stream Restoration Score (1 - 5 points)</b>	
Directly reduces downstream velocities	1 pt
Provides extended detention control for sub-bankfull floods	2 pt
Provides habitat or supports fishery reintroduction	3 to 5 pt
<b>Cost Score (1 - 5 points)</b>	
Construction cost estimated at less than \$10,000	5 pt
Between \$10,001 and \$25,000	4 pt
Between \$25,001 and \$50,000	3 pt
Between \$50,001 and \$100,000	2 pt
More than \$100,000	1 pt
<b>Ease of Implementation Score (1 - 5 points)</b>	
Publicly owned site	2 pt
Access and staging are good or excellent	1 pt
Existing maintenance authority is in place	1 pt
No major wetland permits or other approvals needed	1 pt
<b>Public Benefit (1 - 5 points)</b>	
Site located in priority watershed	1 pt
Benefits small scale citizen habitat project	1 pt
Provides community visibility or amenity	1 pt
Provides environmental education/monitoring opportunity	1 pt
Supports a partnership effort	1 pt
<p>Note: Sample scoring system based on Mid-Atlantic region. Scoring parameters and point ranges may vary from region to region.</p>	

In addition, the investigator verifies approximate wetland limits, notes stream conditions, and potential conflicts with or limitations from utility crossings, construction and maintenance access. Potential conflicts with sensitive resources and adjacent land uses are cataloged, available storage estimated, and a preliminary concept sketch is prepared. Photographs are also taken of the site and vicinity. It is helpful to prepare a field package before visiting each site. The field package contains background information each candidate site, such as topographic maps, storm drainage network wetland maps, and any utility information.

**3. Subwatershed Inventory**

Once the field investigation is complete, each feasible retrofit site is cataloged in a retrofit inventory. The concept sketches are refined and site specific information added. A preliminary cost estimate is prepared and the RIS is finalized. Often, more than one type of stormwater practice may be designated as suitable for a particular location.

The completed inventory is then used to compute the amount of area controlled within the subwatershed. The total area of the subwatershed draining to proposed retrofit sites is used to select priority subwatersheds for restoration implementation. A sample scoring system (Table 3) provides watershed managers with a tool for allocating resources and developing an implementation approach for construction of specific projects. Scoring parameters can be modified for regional differences or to place extra emphasis on a particular issue of concern.

In some watersheds, prioritizing restoration efforts can be targeted by estimating urban pollutant loads to receiving waters, to identify which land uses within subwatersheds are contributing the greatest load to the receiving waters. In other watersheds, efforts are targeted on the basis of a stream quality ranking system that incorporates parameters such as habitat value and stream geometry.

**Watershed Source Control through Pollution Prevention**

The second major component of watershed restoration involves identifying and implementing source control measures within selected subwatersheds. Controlling pollution at its source must be a major objective. The best structural stormwater practice retrofits have pollutant removal efficiencies ranging from 40% to 80%, but still discharge some pollutants downstream (Schueler, 1994). Even the best stormwater retrofit program usually cannot control 100% of the subwatershed area. The goal of source control is to prevent pollutants from entering the storm drain network in the first place. The biggest challenge for watershed managers is that an effective source control requires changing people's

behavior. Therefore, efforts geared towards watershed education and behavior modification are likely to have big payoffs.

A good method to identify source control opportunities targets the major land uses within a subwatershed (industrial land uses, which are permitted under the NPDES program, may be handled separately). Where possible, commercial property owners should be identified. Once this is done, business coalitions throughout the subwatershed can be formed for distinct commercial clusters, or by grouping similar businesses together (e.g., vehicle maintenance, food service, warehouse, general retail, etc.).

A random non-regulatory field survey of commercial properties should be conducted to identify evidence of pollutants entering storm drains. Field investigators should look for the presence or absence of pollution prevention practices. The type of practices identified will depend to some extent on the type of business. The type of source control practices to look for are listed in Table 4. The survey should document the location and name of the business, owner information, approximate site area, and approximate impervious area.

Once the survey is complete, business coalition representatives should be selected to help administer the source control program. Informational flyers, targeted at specific businesses (such as automotive-related services), can be distributed to the coalition representatives. The local coalitions will be responsible for implementation of good housekeeping practices, monitoring compliance, and reporting results. Local governments may consider incentives to promote participation in this type of a program, such as special tax incentives, advertising subsidies for environmentally friendly businesses, or special subsidies for stormwater practice implementation.

A residential source control program involves a general review of the residential housekeeping of the watershed. A survey of subwatershed general conditions is conducted, and restoration opportunities targeting specific areas for reducing pollutants are identified (Table 5).

Once the residential survey is complete, homeowner associations and other community involvement groups are contacted to inform their members about the things they can do to reduce pollutants in the streams. Public attitude surveys are one way to assess citizen knowledge of watershed problems and to raise public awareness about watershed restoration issues (Smith *et al.*, 1994). Informational flyers on proper lawn care, auto care, disposal of yard wastes, and recycling of used oil and antifreeze are often included in public education programs. Stream stewardship can also be fostered by storm drain stenciling programs, neighbor-

hood stream clean-up efforts, tree planting days and resident monitoring programs.

#### Urban Stream Enhancement Procedures

For those subwatersheds where biological diversity is to be enhanced, it is critical to assess the condition of the instream aquatic habitat. In many urban streams, the physical changes to channel geometry and habitat are so severe that few places remain to accommodate aquatic life. In order to restore diverse aquatic community, it is often necessary to physically reconstruct instream habitat structure.

A number of habitat-enhancement tools may be used to re-construct in-stream habitat, depending on the conditions of the stream in question. Pool/riffle sequences may be re-established, fish cover may be provided, channel morphology stabilized, fish barriers removed, and streamside areas revegetated. Several habitat enhancement techniques are presented in Table 6 and discussed in greater detail in articles 144 to 150.

Before specific habitat enhancement techniques are proposed, it is necessary to know where and when they are appropriate for the stream. Much of this work can be accomplished during the existing stream condition assessments. Using the RSAT method, for example, field investigators can identify enhancement opportunities while documenting existing conditions.

Using RSAT, the stream network is divided into reach lengths and two to three assessments are conducted over each reach. The segments are evaluated for the following parameters: riparian cover condition, presence and severity of streambank erosion, pool/riffle quality, substrate condition, channel debris, condition of adjacent floodplain, presence of fish barriers, evi-

Table 4: Pollution Prevention. Commercial Properties

#### Check for the Following Good Housekeeping Measures

- Covered material storage or material stored inside
- Covered dumpster & no dumpster spillage
- Maintenance of vehicles inside
- Floor drains connected to sanitary sewer system
- Aboveground storage tanks with secondary containment
- Vehicle washing and steam cleaning using specified wash systems and connected to sanitary sewer
- Covered loading docks
- Covered vehicle refueling areas
- Absence of trash and debris
- Absence of eroded areas and lack of bare surfaces
- Adequate maintenance of stormwater treatment practices
- Disconnected impervious surfaces

**Table 5: Pollution Prevention Survey, Residential Areas**

- Condition of storm drainage system (outfall, catchbasins)
- Condition of roadway surfaces
- Are storm drain inlets and catchbasins stenciled?
- Condition of pervious areas (needleless turf, erosion areas, etc.)?
- Condition of residential lawn quality (is there evidence of excessive use of fertilizer?)
- Are there many vacant lots with local dumping of lawn refuse and other trash and debris?
- Is there evidence of substantial residential auto care and car washing?
- Are there opportunities for reforestation/revegetation?
- Identify candidates for stream stewardship

dence of exposed or leaking sanitary sewers, visible water quality impairment. In addition, adjacent land uses and property ownership, access points for heavy equipment, and presence of adjacent wetlands are documented.

#### **The Cost of Urban Watershed Restoration**

To date, there have been relatively few urban watershed restoration plans completed and even fewer that have been implemented. There is almost no data on the costs to implement a complete urban watershed restoration plan. One estimate, dating to the early 1990s, put restoration efforts within the Anacostia River Watershed at between approximately one-half to one million dollars per square mile of area (ART, 1992). Clearly, more information is necessary to approximate urban watershed restoration costs.

We can gain some information by looking at the costs of individual practices. For example, structural retrofits can range in cost from as little as \$10,000 for minor modifications to an existing stormwater pond to as much as \$750,000 or more for complete design and construction of a major wet, extended detention facility (Karouna, 1989). The implementation of a public outreach program for a moderately sized subwatershed in Prince George's County, Maryland costs approximately \$30,000 annually (Paul, 1995). The cost to area businesses to implement and maintain pollution prevention practices might vary from a few hundred dollars to several thousand dollars per business per year, depending on the type of business. Stream enhancement projects can range in cost from a few thousand dollars for projects relying on donated plant materials and volunteer labor to \$500,000 per mile for complete reconstruction of the stream channel geometry, bank stabilization and riparian revegetation (Black and Veatch, 1994).

#### **Conclusion**

Human activity has impacted the biological integrity and physical characteristics of many urban stream systems. Watershed restoration provides an opportunity to undo many past mistakes; however, many activities have created situations where complete restoration to pre-human conditions is impossible. A realistic program that recognizes the limitations of a restoration program and targets a specific approach is essential. Watershed managers must recognize when to attempt comprehensive watershed restoration and when to pursue strictly stream corridor management strategies. An effective watershed restoration program is most likely to reach successful results when conducted at the subwatershed scale.

A comprehensive watershed restoration plan incorporates several complementary aspects. Stormwater retrofits can mitigate altered stormwater runoff and reduce pollutant loads, but cannot revive an aquatic system by themselves. Pollution prevention helps reduce pollutants at the source but does not affect the peak flows and erosive conditions in the stream. Stream habitat restoration may provide increased stream channel stability and create conditions where aquatic species might prosper, but without reductions in pollutant load, biological diversity is not likely to improve. Urban watershed restoration must be looked at in a comprehensive manner where each element plays a role in producing conditions where the aquatic community and humans can live side by side.

-RAC

**Table 6: Urban Stream Restoration Goals**

Urban Stream Restoration Goals	Techniques/Methods
Control Urban Hydrologic Regime	<ul style="list-style-type: none"> <li>■ Upstream structural retrofits</li> <li>■ Parallel pipe systems</li> </ul>
Remove Urban Pollutants	<ul style="list-style-type: none"> <li>■ Source control pollution prevention efforts</li> <li>■ Upstream structural retrofits</li> <li>■ Increased/enhanced stream buffers</li> <li>■ Elimination of illicit connections</li> <li>■ Erosion &amp; sediment controls</li> </ul>
Restore Instream Habitat Structure	<ul style="list-style-type: none"> <li>■ Create pools/riffles</li> <li>■ Confine and deepen low flow channels</li> <li>■ Provide structural complexity</li> <li>■ Provide in-stream fish cover</li> </ul>
Stabilize Channel Morphology	<ul style="list-style-type: none"> <li>■ Enhance channel geometry (length to width ratio, meander patterns, etc.</li> <li>■ Stabilize severe bank erosion</li> <li>■ Stabilize channel and bed to accommodate bank full discharge</li> </ul>
Replace/Augment Riparian Cover	<ul style="list-style-type: none"> <li>■ Provide enhanced tree canopy over headwater streams</li> <li>■ Stabilize stream banks</li> <li>■ Provide instream overhead cover</li> <li>■ Revegetate stream banks and buffers</li> </ul>
Protect Critical Stream Substrates	<ul style="list-style-type: none"> <li>■ Erosion and sediment controls</li> <li>■ Riffle creation</li> <li>■ Mechanical stream substrate cleanout ("Mudsucker")</li> <li>■ Enhance stream buffers</li> </ul>
Recolonize Stream Community	<ul style="list-style-type: none"> <li>■ Remove fish migration barriers</li> <li>■ Selectively reintroduce pre-disturbance native fish community (where appropriate)</li> </ul>

**References**

Barth, C., B. Daly, E. Reeves, and P. Cada. 1994. *1994 Edition-National Directory of Urban Watershed Restoration Efforts*. Center for Watershed Protection

Galli, J. 1993. *Rapid Stream Assessment Technique (RSAT) Evaluation Method - Step One*. Unpublished Notes. Metropolitan Washington Council of Governments, Washington, DC

Schueler, T. 1994. "Review of Pollutant Removal Performance of Stormwater Ponds and Wetlands." *Watershed Protection Techniques*. 1(1): 17-18

Smith, J., S. Paul, C. Collins, A. Cavacas, M. Lahlou. 1994. "Public Survey and Pollutant Model for Prince George's County." *Proceedings from Watershed '93: A National Conference on Watershed Management*. Pawlukiewicz, J. et. al (eds.)

Anacostia Restoration Team (ART). 1992. *A Blueprint for the Restoration of the Anacostia Watershed*. Metropolitan Washington Council of Governments. Washington, DC

Karouna, N. 1989. *Cost Analysis of Urban Retrofits*. Unpublished report. Metropolitan Washington Council of Governments, Washington DC

Paul, S. 1995. Personal communication. Prince George's County Dept. of Environmental Resources, Watershed Protection Branch.

Black and Veatch. 1994. *Carroll County, Maryland Longwell Branch Restoration Feasibility Study*. Carroll County Maryland, Office of Environmental Services

R0080161

# Stormwater Retrofits: Tools for Watershed Enhancement

**I**mproving aquatic habitat, water quality, and biodiversity within impacted urban streams and rivers are objectives for watershed managers. Stormwater retrofitting is just one available watershed restoration tool. Stormwater retrofits are a series of structural stormwater practices designed to mitigate erosive flows, reduce pollutants in stormwater runoff, and promote conditions for improved aquatic habitat.

Other watershed restoration tools that restore stream habitat and stabilize streambanks are necessary and important for watershed restoration, but without establishing a stable, predictable hydrologic water regime, these tools may not be effective. Erosive conditions and damaging frequent stormwater flows will remain. To successfully improve a stream's overall aquatic health, stormwater retrofitting is a watershed manager's most reliable tool.

Recent efforts in Maryland have identified methods for locating, designing, and constructing retrofits in urban watersheds. Scouting for retrofit sites requires a sound understanding of how, where and which stormwater practices are appropriate for particular situations. This requires an understanding of urban streams, hydrology and stream morphology, and an ability to envision possibilities for enhancement. It is also helpful to have an imaginative approach when attempting to identify appropriate alternatives. Six examples of urban retrofits are identified in Table 1. These retrofits must be adopted to varying site-specific conditions but represent the most common options for urban retrofitting.

**Table 1: Retrofit Examples**

- Retrofit existing older stormwater management facilities (detention ponds)
- Construct new stormwater practices at upstream end of road culverts
- Construct new stormwater practices at storm drainage pipe outfalls (end of pipe)
- Construct small instream practices in open channels
- Construct "on-site" measures at the edges of large parking areas
- Construct new stormwater practices within highway rights-of-way (cloverleaves)

Stormwater retrofits only emphasize pollutant reduction. It should be recognized that *quantity* frequently creates the most severe urban stream impacts. Watershed managers should look for opportunities to combine quantity and quality controls together in stormwater retrofits.

## Stormwater Retrofit Options

### 1. Retrofit existing stormwater management facilities

This option involves converting existing detention facilities (usually dry detention basins) into more functional treatment practices. Older basins are usually modified to become stormwater wetlands or wet ponds. This is perhaps the easiest retrofit option since stormwater is already managed in a distinct location and there is already some resident acceptance and understanding of stormwater management. In addition, modifying existing facilities usually involves minimal impacts to secondary environmental resources (e.g., wetlands, forest cover, migration barriers, etc.).

The retrofit process begins with an analysis of the existing hydraulic characteristics of the facility, reviewing the type of storage originally provided (e.g., two-year, and 10-year storms), and evaluating whether available storage exists for additional water quality treatment. The pond bottom can usually be excavated to create more permanent pool storage (for pond and wetland systems), the embankment can be raised, or the outlet structure modified to obtain additional storage for extended detention.

Another option is to increase the flowpath from inflow point to discharge point by using baffles, earthen berms or pond micro-topography to improve settling conditions. The goal of this type of retrofit is to maintain the original design purpose of the basin as much as possible, while providing additional pollutant treatment. A typical retrofit of an existing detention basin is shown in Figure 1.

### 2. Construct new stormwater practices at upstream end of road culverts

This stormwater retrofit option is installed upstream from existing road culverts by constructing a control structure and excavating a micro-pool. The control structure can consist of a gabion or concrete weir structure or a riser/barrel configuration. The micro-pool

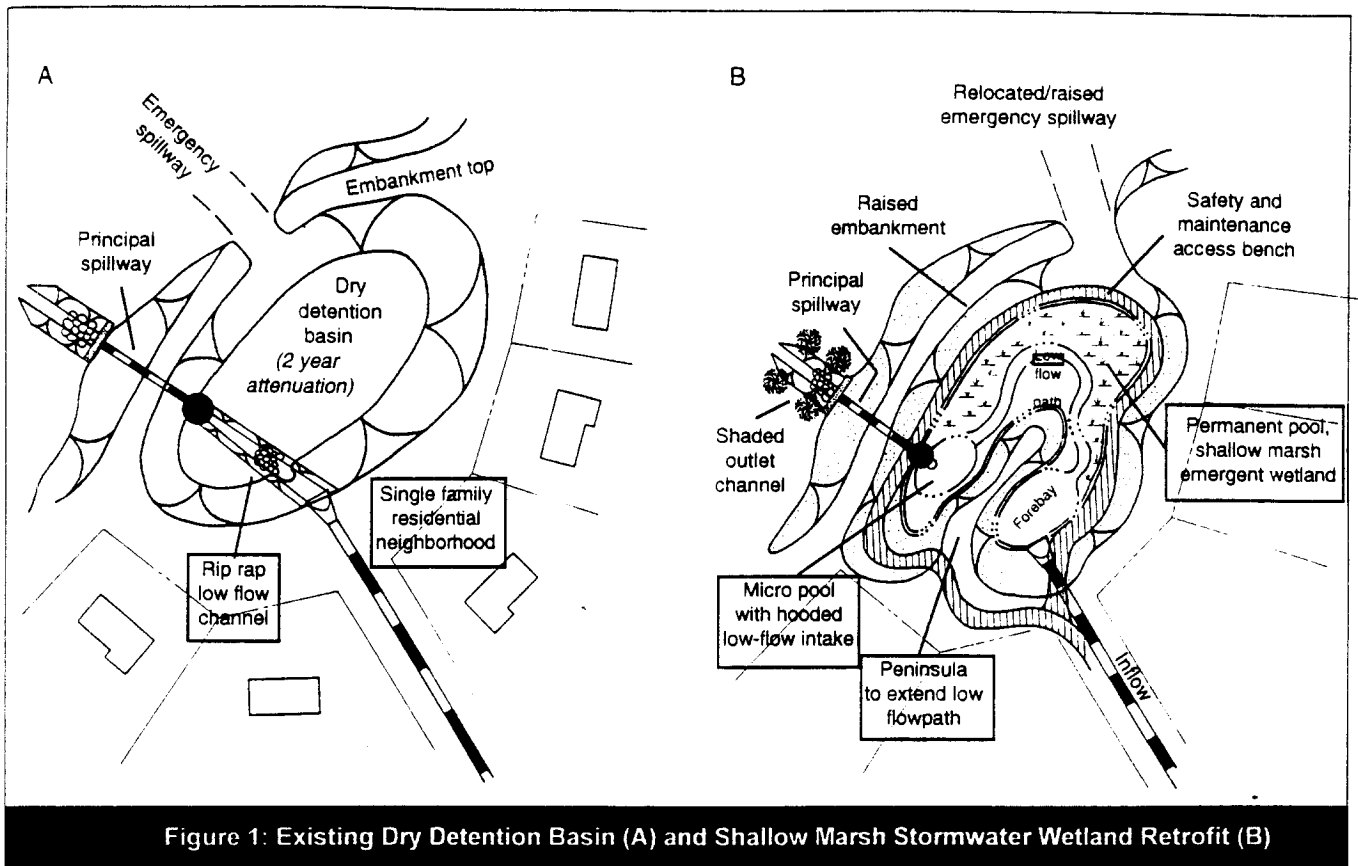

Figure 1: Existing Dry Detention Basin (A) and Shallow Marsh Stormwater Wetland Retrofit (B)

is a small permanent pool with a target volume equivalent to 0.1 watershed inch of storage. This method can be utilized to provide extended detention of runoff with a maximum depth of six feet above the culvert invert. If the upstream area is an open floodplain, it may be possible to construct a wet pond or stormwater wetland retrofit.

Stormwater quality control can usually be accommodated with this type of retrofit. Since roadways are not always constructed as stormwater pond embankment, special measures may be necessary to ensure that these retrofits will meet dam safety specifications for seepage control and passage of the 100-year storm. Secondary impacts also need to be considered with this type of retrofit. Examples of secondary impacts include expansion of the 100-year floodplain, creation of fish migration barriers, modification of upstream wetland hydrology, and potential impacts to existing forests. A typical retrofit utilizing an existing road crossing is shown in Figure 2.

### 3. Construct new stormwater practices at storm drainage pipe outfalls

This retrofit often consists of constructing new stormwater treatment practices at the immediate terminus of storm drainage systems. These retrofits are often designed as off-line stormwater practices. Flow splitters can be utilized to convey the water quality treatment

volumes to a stormwater practice while allowing larger storms to bypass the retrofit. Examples of stormwater practices that are often applied in this retrofit option include sand filters, peat-sand filters, bioretention areas (article 110), off-line wetlands and wet ponds (refer to article 150 for more information on parallel pipe systems and flow splitter design). Consideration must be given to regulatory restrictions when constructing stormwater practices in a floodplain. Figure 3 shows a schematic plan for this method of retrofitting.

### 4. Construct small instream practices in channels

Previously channelized streams are potential sites for small instream detention structures in some small subwatersheds. These retrofits consist of small weir walls or check dams placed across the channel. A small ponding area is provided upstream of the retrofit for establishing wetland vegetation. This type of retrofit is usually very easy to install and can provide some moderate pollutant removal benefits, but can have potentially adverse impacts on the floodplain. Existing floodplain levels must be carefully compared to those created by the retrofit. Often these channelized streams have been designed to convey a certain frequency storm event with a given cross-section. Modification of this geometry may affect adjacent properties and downstream structures.

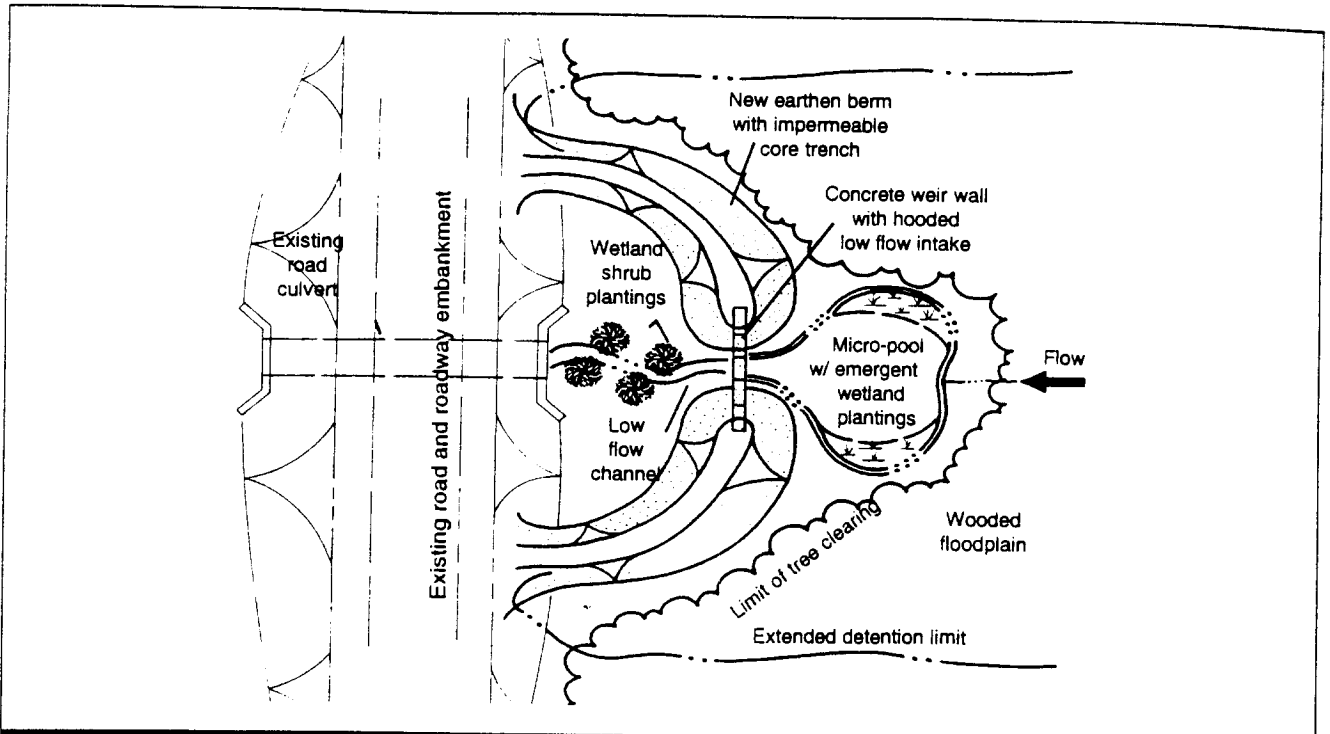

Figure 2: New Stormwater Practice at Upstream End of Road Culvert

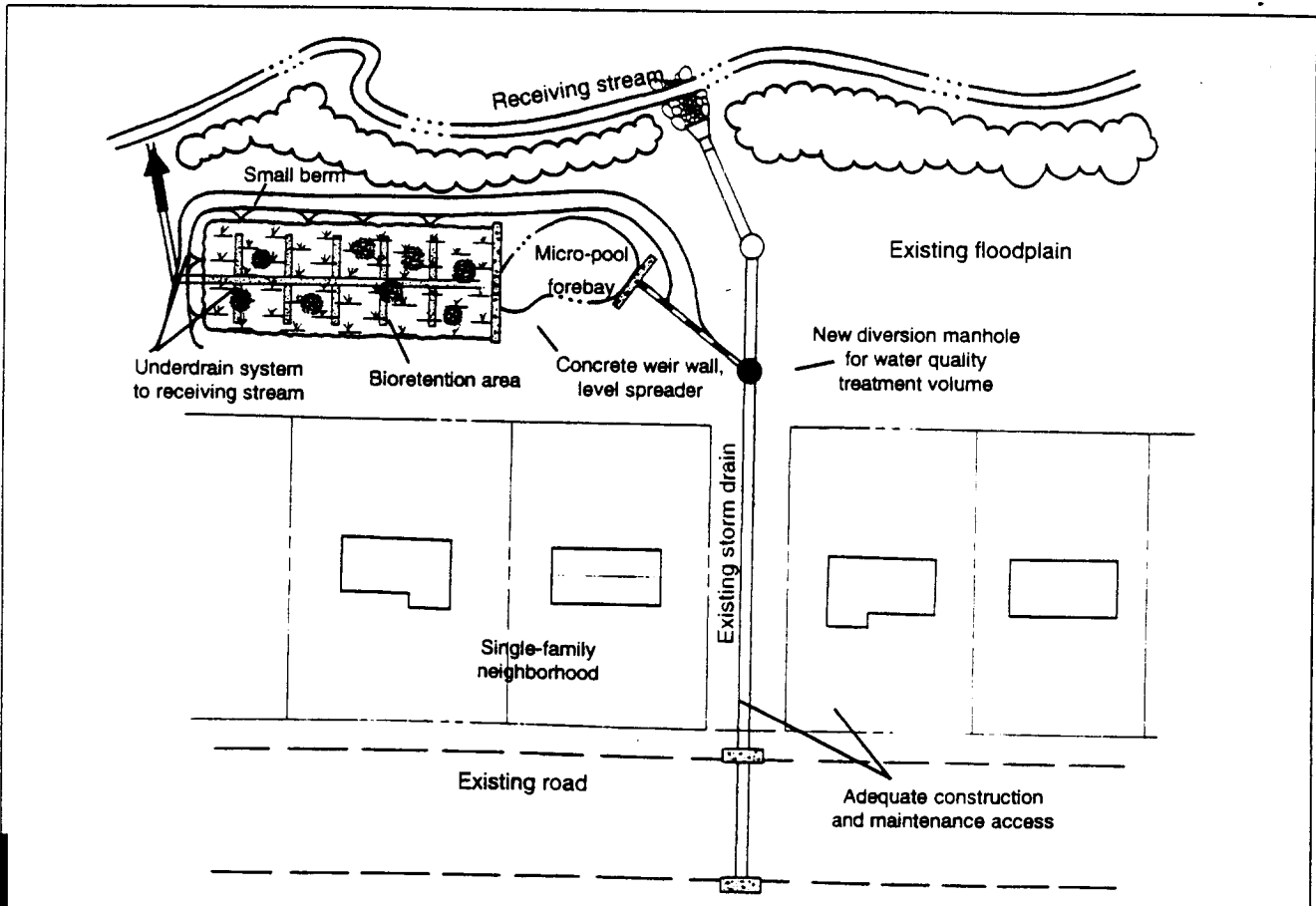

Figure 3: New Stormwater Practice at Existing Storm Drain Outfall (Off-Line Bioretention)

**Table 2: Elements to Consider in Stormwater Retrofitting**

<b>Element</b>	<b>Consideration</b>
Construction/ maintenance access	Ensure that retrofit site has adequate construction and maintenance access and sufficient construction staging area
Utilities	Verify existing utility locations, assess likelihood for conflicts, avoidance or relocation potential
Wetlands, forests, and sensitive streams	Identify existing natural resources and estimate sensitivity, avoid and minimize impacts where possible, assess likelihood for conflicts and permit acquisition complications
Conflicting land uses	Identify adjacent land uses, select stormwater practices that will be compatible with nearby properties
Complementary restoration projects	Look for opportunities to combine projects, such as combining stream stabilization and habitat restoration with retrofitting in a complementary manner
Permits and approvals	Assess the difficulty of obtaining permits and identify necessary agencies to contact
Retrofit purpose	Define project purpose (i.e., is the retrofit intended to help stabilize the hydrologic regime in terms of quantity controls or is the retrofit more directed at pollutant removal in terms of quality controls?)
Cost	Retrofits can vary in cost from a few thousand to several hundred thousand dollars. A preliminary cost assessment should be conducted as part of a stormwater practice selection and implementation process

*5. Construct on-site measures at the edge of large parking areas*

Large parking lots are often ideal candidates for the installation of new stormwater retrofits. Some recent techniques, such as bioretention, improved porous pavement and sand filters may be appropriate for these retrofits. Infiltration practices, underground vaults, or other quantity practices may also be appropriate in some situations. Refer to articles 105 and 110 for detailed information on these stormwater practices.

*6. Construct new stormwater practices in highway rights-of-way*

Existing highway systems often have significant open spaces to install various stormwater retrofits. In particular, cloverleaf open space can be an ideal location for stormwater wetlands and pond systems if drainage areas/patterns allow. Care must be taken to not create a safety hazard for traffic, and maintenance access should be an integral part of the design.

**Conclusion**

Table 2 provides some key elements to consider in the selection and design of stormwater retrofits. Designers and watershed managers must consider a wide variety of issues when selecting retrofit options.

In summary, retrofitting is a useful tool for watershed enhancement and stream quality improvement. Several techniques are available to help establish a stable hydrologic condition and reduce stormwater runoff pollutants to receiving waters. Retrofitting requires a variety of skills for successful identification, design, and implementation. When combined with other watershed restoration efforts such as stream bank stabilization and habitat improvements, retrofitting can contribute to better urban waters which sustain a diverse and healthy aquatic ecosystem.

—RAC



# Sligo Creek: Comprehensive Stream Restoration

**P**erhaps the most comprehensive urban stream restoration project yet attempted is Sligo Creek. An urban creek that drains through Maryland's Piedmont, Sligo Creek had become severely degraded over time. An interagency team from Metropolitan Washington Council of Governments, Interstate Commission on the Potomac River Basin, Montgomery County Department of Environmental Protection, Maryland Department of the Environment, and Maryland-National Capitol Park and Planning Commission has

worked for a decade to restore the stream. The restoration strategy consisted of comprehensive implementation of stormwater retrofits, instream habitat creation, riparian reforestation, and fish reintroductions (see Table 1). Biomonitoring was conducted before, during, and after each phase of the project. The project was conducted in two phases: first Wheaton Branch and then the Sligo Creek mainstem and Flora Lane tributary. Figure 1 shows the approximate location of the project's components.

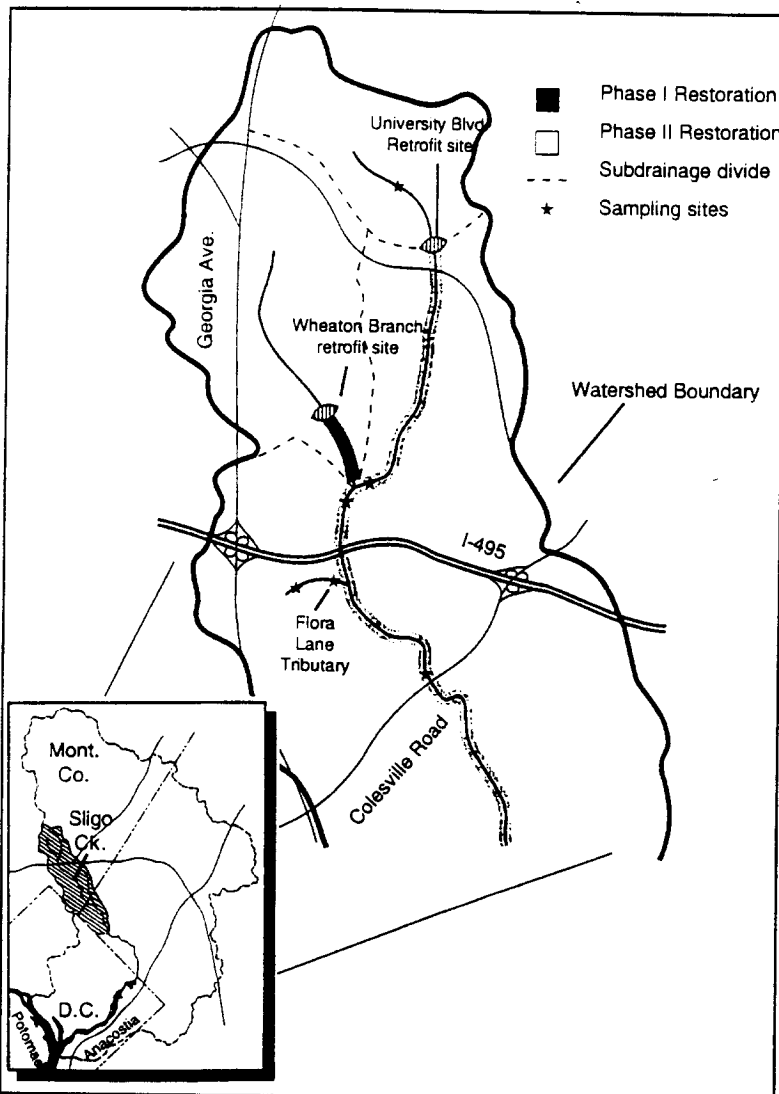

Figure 1: Vicinity Map (Galli, 1992)

## Wheaton Branch

Wheaton Branch was a severely degraded urban stream. Its 800-acre subwatershed is approximately 55% impervious. Frequent flooding had increased the stream channel width from 15 feet to as much as 86 feet (Galli and Schueler, 1992.) The streambed consisted of very large cobbles embedded in silt and clay, much of which was contaminated by petroleum hydrocarbons. Water temperatures averaged 2-7°C warmer than nearby forested streams. The aquatic community was severely degraded, with only two pollution-tolerant species of fish present: blacknose dace (*Rhinichthys atratulus*) and northern creek chub (*Semotilus atro maculatus*). In comparison, less heavily-impacted reference streams in the Anacostia basin contained 12 to 15 fish species. Indeed, the biological quality of Wheaton Branch, as measured by the Index of Biologic Integrity (IBI), was rated as poor prior to restoration.

The restoration of Wheaton Branch is unique in that it addressed all restoration steps in a single project. To control stormwater flows and improve water quality, an existing flood control structure was converted into a multi-cell pond/marsh system. With three interconnected pools (total surface area 5.9 acres), this retrofit detained runoff for as long as 36 hours (Figure 2). A system of weirs, pipes, and gate valves was then used to gradually release the water. Construction of the pond/marsh system was completed in June, 1990.

After the stormwater retrofit pond was completed, the next step called for the replacement of nearly all functional components of the stream ecosystem within a 900-foot reach. Stone wing deflectors and boulders were installed to concentrate stream flow thereby enhancing pool/riffle areas. Notched log drop structures were used to create pools. Brush bundles, rootwads, and imbricated rip-rap were employed to stabilize banks and provide cover (Figures 3 and 4). Debris was

**Table 1 (A): The Wheaton Branch "Prescription"**

Location: Montgomery Co., MD  
 Watershed size: 800 acres  
 Degree of Imperviousness: 55 percent

Restoration Step	Application in Wheaton Branch
Control urban hydrologic regime and improve water quality	<ul style="list-style-type: none"> <li>Upstream stormwater management pond retrofit</li> </ul>
Remove urban pollutants	<ul style="list-style-type: none"> <li>Upstream pond retrofit</li> </ul>
Restore/create instream habitat structure	<ul style="list-style-type: none"> <li>Notched log drop structure</li> <li>Imbricated rip-rap</li> <li>Rootwad</li> <li>Brush bundles</li> <li>Boulder clusters</li> <li>Single and double-wing deflectors</li> </ul>
Stabilize channel	<ul style="list-style-type: none"> <li>Double -wing deflector</li> <li>Imbricated rip-rap</li> <li>Rootwad</li> <li>Brush bundles</li> </ul>
Replace/augment riparian cover	<ul style="list-style-type: none"> <li>Reforestation</li> </ul>
Protect critical stream substrates	<ul style="list-style-type: none"> <li>Upstream pond retrofit</li> <li>Wing deflectors</li> </ul>
Recolonize Stream Community	<ul style="list-style-type: none"> <li>Fish reintroduced</li> </ul>

**Table 1 (B): The Sligo Creek "Prescription"**

Location: Montgomery Co., MD  
 Watershed size: 8,500 acres (in Montgomery Co.)  
 Degree of Imperviousness: 36 percent

Restoration Step	Application in Sligo Creek
Control urban hydrologic regime	<ul style="list-style-type: none"> <li>Upstream stormwater management pond retrofit</li> </ul>
Remove urban pollutants	<ul style="list-style-type: none"> <li>Upstream pond retrofit</li> <li>Sewer repairs and reconstruction</li> </ul>
Restore/create instream habitat structure	<ul style="list-style-type: none"> <li>Log drop structures</li> <li>Single and double-wing deflectors</li> <li>Parallel pipe</li> </ul>
Stabilize channel	<ul style="list-style-type: none"> <li>Rip-rap</li> <li>Coconut rolls</li> <li>Parallel pipe</li> </ul>
Replace/augment riparian cover	<ul style="list-style-type: none"> <li>Reforestation</li> </ul>
Protect critical stream substrates	<ul style="list-style-type: none"> <li>Upstream pond retrofit</li> <li>Wing deflectors</li> </ul>
Recolonize stream community	<ul style="list-style-type: none"> <li>Fish reintroduced</li> </ul>

removed from the stream and recycled for root wads and log drop structures. Boulders were carefully stacked to produce underwater crevasses for fish refuge. Beside the stream, two small vernal pool areas were excavated for amphibian habitat, and downed trees and logs were positioned to create cover for small animals. Areas adjacent to the stream were reforested using locally obtained native trees and shrubs to complete the habitat work. Species used for reforestation included red maple (*Acer rubrum*), green ash (*Fraxinus pennsylvanica*), sycamore (*Plantanus occidentalis*), tulip poplar (*Liriodendron tulipifera*), and spicebush (*Lindera benzoin*). A total of 19 different tree and shrub species were used. This work was completed in April, 1991.

Once stream habitat had been improved, native fish were incrementally reintroduced (1992). Reintroduction was necessary because of downstream fish barriers. The first phase involved stocking less prolific species that were electrofished from nearby streams and transferred to Wheaton Branch. Reintroductions were phased so that less prolific species were given a chance to become established without competition from more prolific species. Subsequent stockings were conducted in 1993 and 1994. Volunteers formed a "bucket brigade" to assist the restocking effort. See Table 2 for a partial list of reintroduced species.

Preliminary monitoring results indicate that Wheaton Branch has responded reasonably well to the project: numbers of both fish species and macroinvertebrates seem to have improved. In particular, some species that are indicators of good water quality have returned (Galli, 1995). The most dramatic improvements, however, appear to be occurring downstream of Wheaton Branch in the Sligo Creek mainstem.

### Sligo Creek

Although Sligo Creek is almost entirely bordered by parkland, its 13.3 square mile watershed lies within one of the most densely populated areas in the Washington D.C. region (Bandler 1990b). Extensive development has covered over or dried up all but two of its major tributaries. Over 60% of the forest cover has been lost in the watershed since 1932. From a narrow stream of perhaps 10 to 15 foot width, Sligo had become as wide as 50 feet. While much of the mainstem of Sligo Creek had been armored with rip-rap, it also had very poor aquatic diversity: only three fish species present and an IBI score of zero.

The approach to the restoration of Sligo Creek's mainstem was generally similar to that used at Wheaton Branch. Upstream stormwater retrofits included conversion of a dry pond to a pond/marsh system providing 40 hours of extended detention. Instream habitat structures were installed at 19 key points along a three mile segment of the mainstem. Underutilized wet picnic

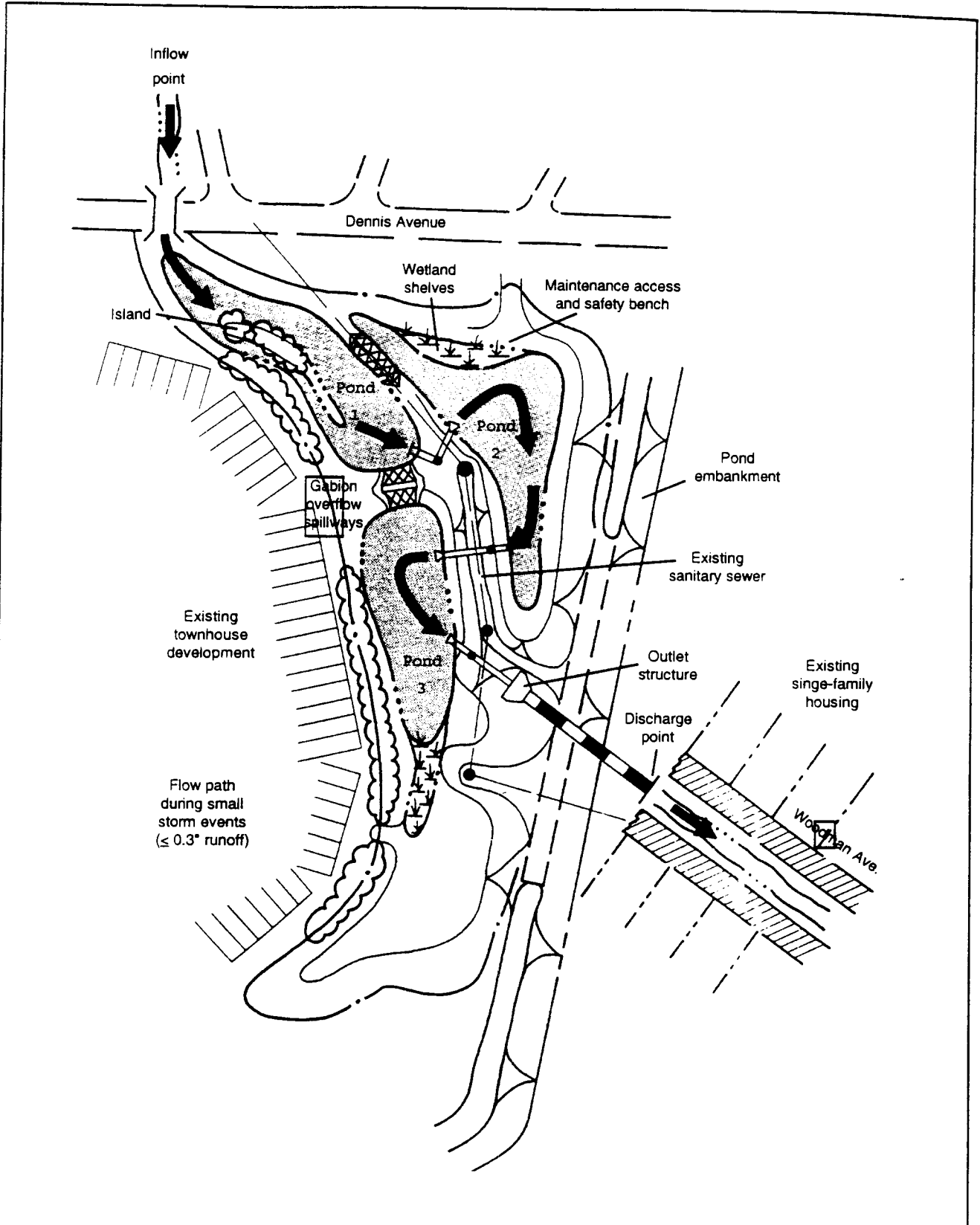

Figure 2 (A): Wheaton Branch Retrofit (Adapted from Loiederman Assoc. Inc.)

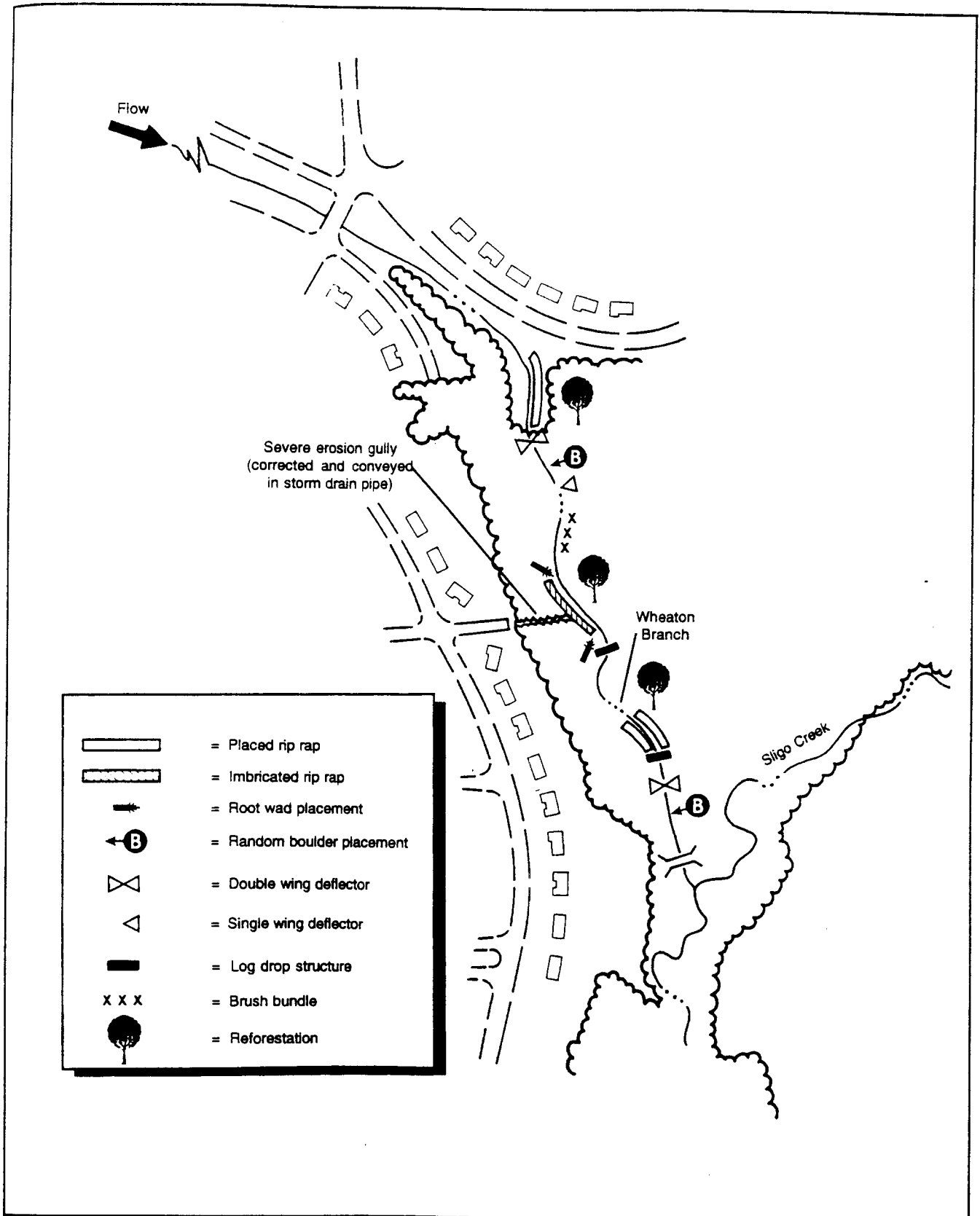

Figure 2 (B): Placement of Stream Restoration Elements

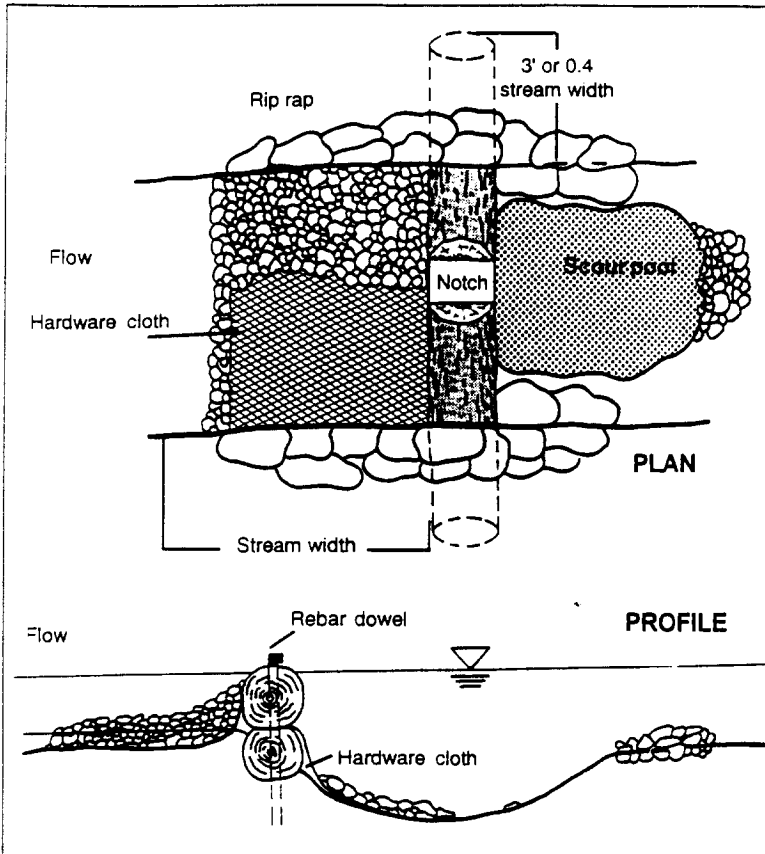

Figure 3: Typical Log Drop Structure (Galli and Schueler, 1992)

grounds were converted to wetland areas to provide additional habitat. Streamside reforestation is ongoing. As in Wheaton Branch, preliminary monitoring has indicated that the stream has responded well to the project: numbers of fish species seem to have improved and some species that are indicators of good water quality have returned.

### Conclusions

Preliminary results at Sligo Creek and Wheaton Branch seem to indicate that by using a comprehensive approach, dramatic improvements are possible even in a highly degraded urban stream. John Galli and his colleagues continue to study the stream's long term physical, chemical, and biological response to the restoration effort. With a unique multi-year dataset covering fish, macroinvertebrates, and habitat quality, analysis of the Sligo Creek restoration will greatly enhance the literature of stream restoration.

—CAB

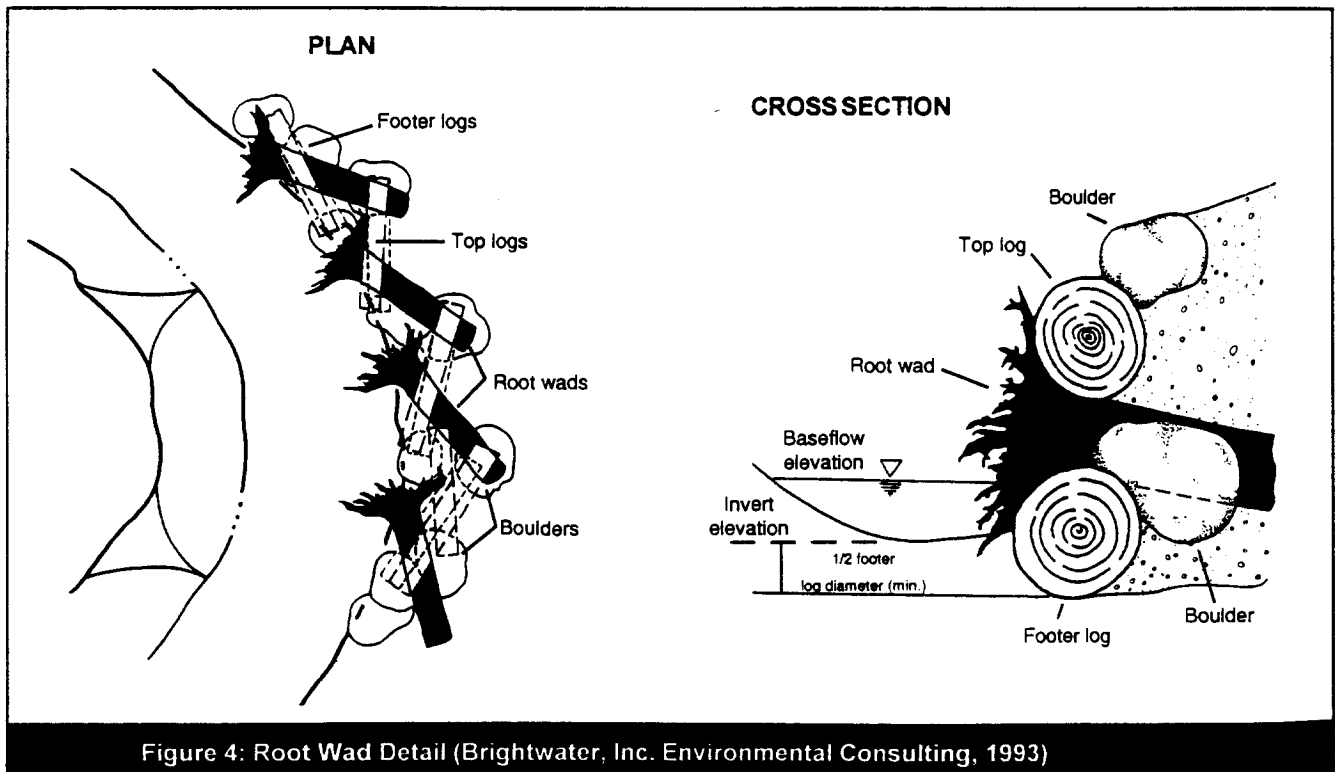

Figure 4: Root Wad Detail (Brightwater, Inc. Environmental Consulting, 1993)

**Table 2: Fish Reintroduced Into Wheaton Branch and Sligo Creek**

Common name ( <i>Scientific name</i> )	Wheaton Branch	Sligo Creek
Bluntnose minnows ( <i>Pimephales notatus</i> )	✓	✓
Cutlips minnow ( <i>Exoglossum maxillingua</i> )	✓	✓
Silverjaw minnow ( <i>Ericymbia buccata</i> )		✓
Common shiner ( <i>Notropis cornutus</i> )	✓	✓
Satinfin shiner ( <i>Notropis spilopterus</i> )		✓
Spottailed shiner ( <i>Notropis hudsonius</i> )		✓
Swallowtail shiner ( <i>Notropis procne</i> )	✓	✓
Longnose dace ( <i>Rhinichthys cataractae</i> )	✓	✓
Rosyside dace ( <i>Clinostomus funduloides</i> )	✓	✓
Tessellated darter ( <i>Etheostoma olmstedii</i> )	✓	✓
White sucker ( <i>Catostomus commersoni</i> )	✓	✓
Northern hog sucker ( <i>Hypentelium nigricans</i> )	✓	✓
Bluegill sunfish ( <i>Lepomis macrochirus</i> )		✓

Because the project and data analysis are ongoing, this is a partial list of reintroduced fish. (Cummins and Stribling, 1992)

**References**

Anacostia Restoration Team. 1991. *A Commitment to Restore our Home River*. Metropolitan Washington Council of Governments, Washington, DC

Bandler, B. 1990a. *In the Anacostia Watershed*. Fall, 1990

Bandler, B. 1990b. *Restoring Sligo Creek*. September, 1990. ICPRB.

Bandler, B. 1992. *In the Anacostia Watershed*. Spring, 1992. ICPRB.

Cummins, J. and J. Stribling. 1992. "Wheaton Branch Retrofit Project: 1990-91 Biomonitoring Project." *ICPRB Report # 92-1*. Interstate Commission on the Potomac River Basin, Rockville, MD

Galli, J. 1995. Personal communication.

Galli, J. and Schueler, T. 1992. "Wheaton Branch Stream Restoration Project." In: *Watershed Restoration Sourcebook*. Metropolitan Washington Council of Governments, Washington, DC

# Bioengineering in Four Mile Run, Virginia

by Jay West, Save Our Streams Program, Izaak Walton League of America, Inc.

In some urban streams, the goal for stream restoration is very limited—to stabilize severely eroding banks using native plant materials. Traditionally, eroding banks were “protected” by armoring them with large rocks known as rip-rap. While rip-rap is effective in preventing erosion on small streams, it often eliminates the natural vegetation that contributes to stream quality.

Bioengineering, on the other hand, can protect the banks from erosion while providing quality streamside vegetation. A good example of a site where bioengineering has been demonstrated is Four Mile Run, an urban creek in Northern Virginia (Table 1).

Four Mile Run drains an urban watershed of some 20 square miles, that is about 40% impervious (Figure 1). Many of the small headwater streams that drained to Four Mile Run have been enclosed in storm drain pipes. Over 35 stream miles have been lost in this manner over many decades of development (Waye, 1994.) As a consequence, Four Mile Run is heavily influenced by stormwater runoff. Both water quality and aquatic habi-

tat are poor. The remaining natural channels exhibit significant bank erosion, with vertical banks ranging from three to eight feet tall.

The Izaak Walton League coordinated a cooperative effort to demonstrate that bioengineering techniques could stabilize eroding banks. The League also wanted to show that a combination of citizens and public agencies could implement these techniques in a cost-effective manner. For demonstration purposes, the League looked for a stream reach with good access, no tree canopy, and eroding bank heights less than four feet. A site meeting these requirements was found in an open and unwooded park setting, adjacent to a greenway heavily used by pedestrians, joggers, and bicyclists. Figure 2 shows the project site before stabilization.

The project began in February 1994. The concept for bank stabilization was to employ bioengineering on the inside of a shallow bend. (An earlier project had placed rip-rap on the outside of the bend where erosional energy was greatest.) The bioengineering treatment involved regrading the bank to achieve a more gentle slope (2:1 horizontal to vertical.) Two shallow trenches were constructed parallel to the stream on the bank contour (see Figure 3). Fascines or bundles of dormant willows and dogwood were then placed in trenches along the contours of the bank. Each fascine was about seven feet long, with the rooted ends facing upstream.

The site has been frequently inspected to see how well it holds up to erosive stormflows. Figure 4 shows the site two weeks after installation, shortly before the grass had become fully established. Within 10 weeks, the willows and dogwoods had sprouted, and a thin layer of fine silt had been deposited over the erosion control fabric. The growth and sprouting of the fascines was not as great as expected during the growing season, possibly because the fascines were not completely dormant at the time of planting. Overall, plant growth was relatively sparse, and some weeds had invaded the site. After four months, some erosion was reported at the toe of the bank, and the designers considered placing a rip-rap layer to protect the base of the slope. Inspection during the second growing season has indicated greater sprouting success for the willows and dogwoods.

**Table 1: The Four Mile Run “Prescription”**

*Location:* Falls Church, VA  
*Watershed size:* 20 square miles  
*Degree of Imperviousness:* 40 percent

Restoration Step	Application in Four Mile Run
Control Urban Hydrologic Regime	N/A
Remove Urban Pollutants	N/A
Restore Instream Habitat Structure	N/A
Stabilize Channel	Stabilize severe bank erosion with live fascines
Replace / Augment Riparian Cover	Planted willows
Protect Critical Stream Substrates	N/A
Recolonize Stream Community	N/A

**R0080172**

The Four Mile Run project shows the possibilities for repairing streambanks using volunteers. With donated plant materials and free grading services, plus volunteer labor, the project cost less than \$2 per linear foot (for a more detailed breakdown of the costs of streambank erosion repair, see Table 2.)

—CAB

#### References

- Black and Veatch. 1994. Carroll County, Md. *Longwell Branch Restoration Feasibility Study*. Volume 1
- Waye, D. 1994. *Interesting Fun Facts About Four Mile Run*. Northern Virginia Planning District Commission

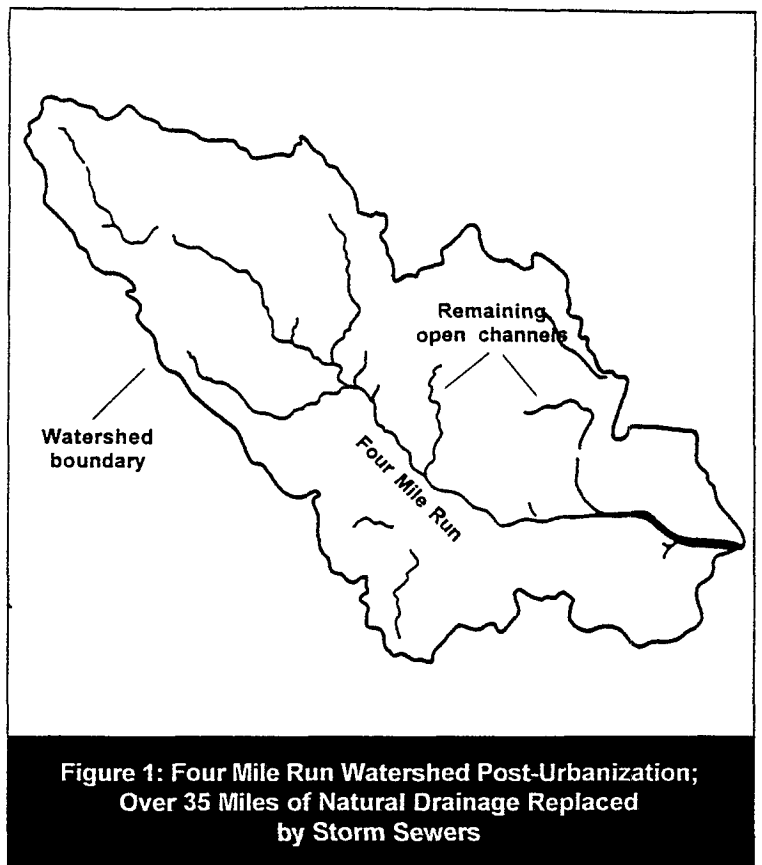

Figure 1: Four Mile Run Watershed Post-Urbanization; Over 35 Miles of Natural Drainage Replaced by Storm Sewers



Figure 2: Before Restoration, the Site Was Characterized by Actively Sloughing, Vertical Banks



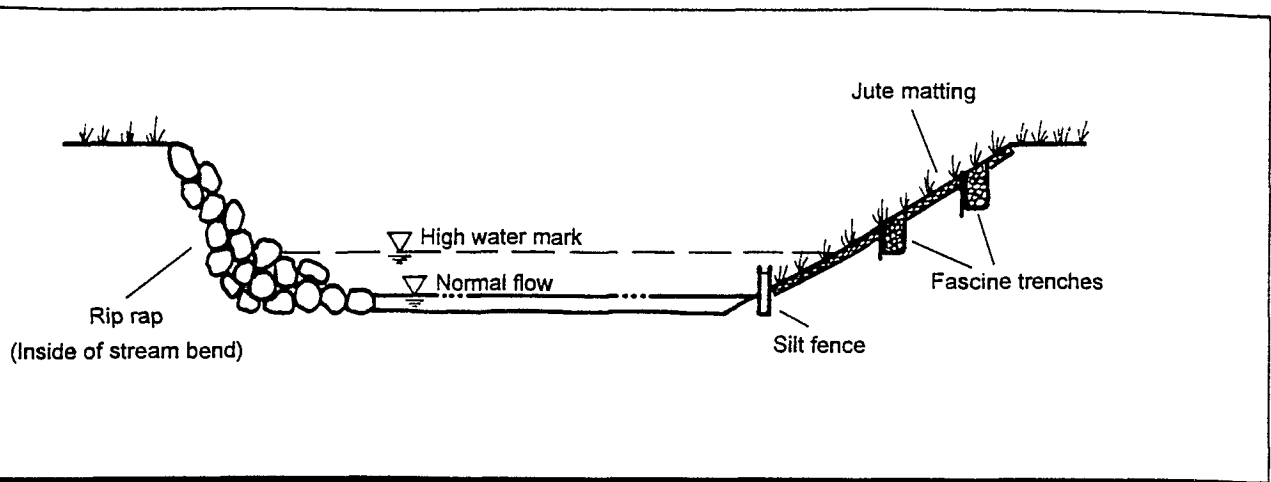

Figure 3: Bank Stabilization Technique Used at Four Mile Run



Figure 4: After Restoration: Two Weeks After Installation of the Plant Materials, Grass Started to Sprout

Table 2: Streambank Erosion Comparing Bioengineering and Rip-Rap Armoring

Component	Cost/Linear Foot
1. Bank Regrading	\$ 8.73
2. Rip-Rap Stabilization	\$ 5.94
3. Vegetative Stabilization	
Willow stakes, jute, hydroseed	\$14.17
Willow fascines, jute, hydroseed	\$15.97
Coconut logs, jute, hydroseed, plants	\$10 - 20
Container plants, jute, hydroseed	\$23.47
Donated fascines, volunteer labor	\$1.73

Sources: Hoeger, pers. comm.; Black and Veatch, 1994

## Coconut Rolls as a Technique for Natural Streambank Stabilization

**E**roding streambanks are a ubiquitous problem along urban streams. Traditional solutions have involved hard engineering methods such as rip-rap, channelization, and retaining walls to secure the banks. It was reasoned that only hard material could withstand the enormous erosional energy that occurs during large storm events. Unfortunately, hard engineering techniques are often detrimental to the streamside ecosystem and may be less than satisfactory in controlling erosion.

Natural alternatives to streambank stabilization have their weak points as well; for example, willow stakes planted directly into an eroding bank may not withstand large storms. However, there is a fairly new method on

the market for controlling erosion by the use of rolls made of natural coconut fiber.

A key design issue for streambank stabilization is how to physically protect the bank from erosion until the vegetation has become fully established. One solution is to use rolls of coconut fiber (also known as coir fiber rolls) along the toe of the bank. The coconut roll acts as a flexible but resistant foundation for streambank plantings (Figure 1). Fiber rolls are staked along the toe of the bank, where they retain water and nutrients and are planted with native hydrophytic plants. The coir rolls eventually degrade but give plants enough time to form a dense network of intertwining roots that holds the bank (Figure 2, A and B).

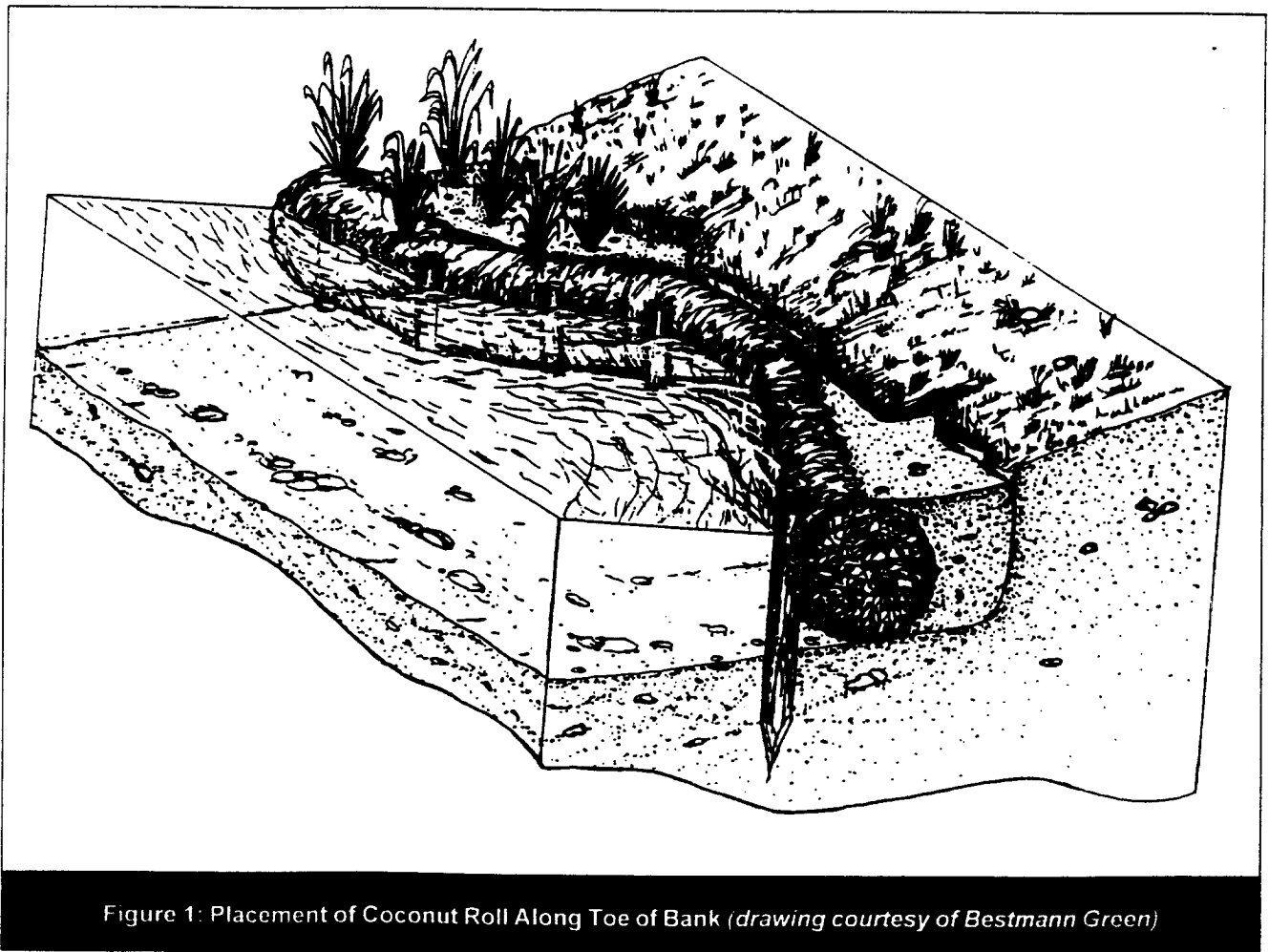

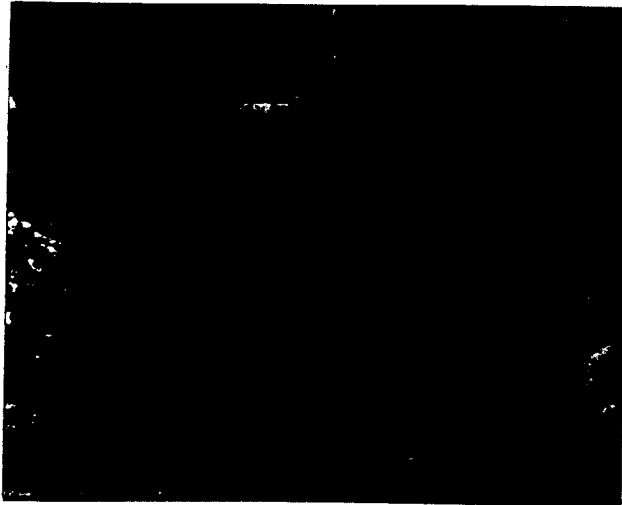

A



B

Figure 2: Vegetation Establishment on Coir Rolls: Mystic River, Medford, MA October 1993 (A) and October, 1994 (B)

The prescription for the use of coconut rolls for streambank stabilization depends on the size of the stream, the slope of the eroding banks, and the expected stream velocity. Best results have been obtained in low-order streams, with graded or ungraded bank slopes of 3:1 or 4:1 (horizontal:vertical) and stream velocities between 2.5 and 7 ft/s. As with most bioengineering techniques, the use of coconut rolls requires full or partial sun for the plants to grow.

Typically, each project is designed by an interdisciplinary team of hydrologists, wetland experts, or landscape architects. In some cases, the existing eroded bank must be graded to achieve the more gentle side-slopes required for bioengineering (3:1). Seeded coconut logs, about 20 ft in length, are anchored along the toe of the bank and secured with stakes. Areas above the log may be stabilized by mats of coconut fiber or jute. Trees, shrubs and ground cover are then planted in the bank, using hydroseed, containers, or live stakes.

Coconut rolls have been utilized to stabilize eroding stream banks in Little Cedar Creek, a small stream draining a highly urban (60% impervious cover) watershed near Allentown, Pennsylvania. The stream experienced extensive bank erosion due to uncontrolled stormwater runoff from the upstream watershed. The stream, which at one time supported brown trout, had lost much stream habitat.

The City of Allentown first used rock armoring to keep the banks from eroding further. This costly approach was abandoned by the City after it was found

that it created downstream bank erosion problems. After public meetings were held, coconut rolls were used as an alternative on approximately 1,400 linear feet of stream channel (both banks). The coconut rolls were installed and planted over a two-month period, and City officials have been pleased with the results. Over half of the native plant species have persisted (Table 1) and many other volunteer species colonized the site after two growing seasons. No visible erosion near the treatment area was observed, and anecdotal reports were made of improvements in the fish community.

Coconut logs were also used to stabilize the eroding banks of a small urban stream in Yonkers, New York. Once again, the streambanks were highly eroded due to stormwater runoff from upstream development. The eroding stream banks were cleared of woody vegetation, and the steeply sloping banks were graded to achieve a gentle slope. The toe of the streambank was protected by an anchored coconut roll, and mats of coconut were used to protect the upper bank from erosion. Sixteen species of native trees, shrubs, and ground cover were planted in the newly reshaped bank. Most of the planted vegetation survived and an equal number of volunteer species colonized the stream bank. Reports indicate that the vegetated streambank continues to prevent erosion, despite numerous sub-bankfull, bankfull, and over-bank floods.

The experience so far with coconut logs indicates that they can be a very effective method to repair

streambank erosion on small streams with gentle, unwooded slopes. Best results are achieved when native plant species are used and the plantings are carefully maintained during the first few months. The cost of the coconut log approach is about \$10/linear foot for materials; a four-person crew can plant from 200 to 300 ft/day (*Note: Cost can increase by an additional \$9/linear foot if extensive regrading of the bank is needed; for a general cost comparison.*)

Several interesting questions remain about coconut logs. For example, at what stream size should coconut logs be replaced by a layer of stone at the base of the streambank? Can shade-tolerant plant species grow fast and dense enough to allow coconut logs (or other bioengineering techniques) to be used in flood plains that have a dense tree canopy? And lastly, what will the streamside plant community be like after a decade or more of woody plant succession—will it still be dense enough to provide erosion control benefits?

—JMC

**Reference**

Greechan, H., S. Hoeger, and P. Summerfield 1993. *County Pioneers Stream Bank Stabilization Method*. Public Works 124 98.

**Table 1: Vegetation Establishment on Coconut Rolls at Two Sites Over Four Years (S. Hoeger, pers. comm.)**

Variables	Trexler Park Allentown, PA (1991-1994)	Tibbetts Brook Yonkers, NY (1991-1994)
No. species planted	27	16
No. original spp. surviving	16	11
No. new species	29	15
Total increase in diversity	60%	61%

# Pipers Creek: Salmon Habitat Restoration in the Pacific Northwest

by Doug Sovern, Gaia Northwest, Inc.

**C**onventional stream restoration practice often assumes that bank and instream restoration will not be successful until excessive stormwater flows are first controlled upstream. However, construction of stormwater retrofits may be too expensive or infeasible. In a large watershed, it may take many years to implement all planned retrofits. Can instream habitat improvements be implemented before stormwater flows are controlled? Experience in Pipers Creek suggests it may be possible, using relatively simple techniques, to maintain or even improve fish populations in advance of stormwater retrofitting in a salmon stream, thus restoring the stream from the bottom up (see Table 1 for the restoration "prescription").

Pipers Creek is a small stream that winds 1.5 miles along a downtown Seattle park (Figure 1). The 1,920 acre watershed is more than 50% impervious. The creek runs through a wooded ravine surrounded by high-density (averaging 10 housing units per acre) residential and

commercial development. Storm flows can reach 300 cfs during a five-year storm. Base flows are a mere 1.5 cfs. Small urban streams like Pipers Creek once provided important freshwater habitat for coho salmon, cutthroat trout, and steelheads.

### Previous Restoration Efforts

The Pipers Creek Watershed Action Plan, developed in 1990, identified public education, regulatory, operating and maintenance, public works, and monitoring projects to restore and enhance the creek. The identified projects included restoration of stream habitat. An earlier effort to prevent stream erosion and trap sediments involved constructing fourteen boulder control structures (large stacked boulders with two- to three-foot wide notches extending from the creek bottom to the structure's top—see Figure 2). Even with the structures, the creek still showed severe degradation due to uncontrolled stormwater flows. For example:

- Many of the boulder control structures had failed as boulders shifted or as the notches became plugged with sediment. Several structures with notches greater than two feet wide were not trapping any sediment at all.
- The stream bottom was covered with fine grained silts.
- Low flow channels within the stream became braided, and the stream channel had lost most of its meanders.
- Very low diversity of flora and fauna was reported, with few taxa of aquatic insects present. However, Pipers Creek still had some crayfish and cutthroat trout present.

**Table 1: The Pipers Creek "Prescription"**

<i>Location:</i> Seattle, WA	
<i>Watershed size:</i> 1,920 acres	
<i>Degree of Imperviousness:</i> > 50percent	
Restoration Step	Application in Pipers Creek
Control Urban Hydrologic Regime	<ul style="list-style-type: none"> <li>■ Erosion control projects</li> <li>■ Source control BMP</li> <li>■ Educational programs</li> <li>■ Within pipe detention</li> </ul>
Remove Urban Pollutants	<ul style="list-style-type: none"> <li>■ No retrofits</li> </ul>
Restore Instream Habitat Structure	<ul style="list-style-type: none"> <li>■ Create pools/riffles</li> <li>■ Confine and deepen low flow channels</li> <li>■ Provide structural complexity</li> </ul>
Stabilize Channel Morphology	<ul style="list-style-type: none"> <li>■ Restore tight meander pattern</li> <li>■ Stabilize channel to accommodate bankfull discharge</li> </ul>
Replace / Augment Riparian Cover	<ul style="list-style-type: none"> <li>■ Provide instream overhead cover</li> <li>■ Revegetate streambanks</li> </ul>
Protect Critical Stream Substrates	
Recolonize Stream Community	

### Bottom-up Restoration Approach

Therefore, a second restoration strategy was undertaken. The concept was to reconstruct elements of instream habitat and reinforce them to withstand high flows. Thus, during periods of low flow, the stream would return to the reconstructed flow pattern and continue to provide habitat. The goals were to do the following:

**R0080178**

- Increase the channel length during low flow periods
- Increase roughness during high flow periods
- Keep the bottom from being scoured
- Provide easier fish passage
- Improve the aesthetic value of the stream
- Increase the number of pools and riffles

Fallen rocks from the boulder control structures and nearby available logs were used to make the required structural changes. A design team representing a range of disciplines planned and supervised the project. Installation was completed in 1991 using the Seattle Conservation Corps at a total cost of \$35,000 for one mile of stream. Project organizers estimate that restoration costs for similar streams might range from \$50,000 to \$90,000 per mile (see Table 2 for descriptions of the structural elements).

### Findings

The immediate response of the stream to the restoration project was successful. Gravel in the streambed became cleaner and insect populations appear to have increased. The percentage of stream area containing pools nearly doubled from 16% to 32% and the total pool volume was greatly increased. There was an eight-fold increase in the fish population nine months after the project was completed (primarily steelheads). Adult chum salmon returned for the first time since 1975 (Table 3).

However, within two years of completing the project, uncontrolled stormwater flows were causing damage to many of the log deflectors. An implication is that one either has to be prepared to maintain the log structures (e.g. be prepared for occasional maintenance using an inexpensive workforce like the Conservation Corps), or use rocks. (In fact, double layers of rock are now used in Pipers Creek wing deflectors.) However, in some cases, even where log deflectors were washed away, the low flow channel continued to hold its shape. In contrast, project planners expect log drop structures to last much longer than log wing deflectors (e.g., for 20 to 25 years). This is somewhat different from the conclusion of research described in article 148. That study found a high failure rate for log structures in general, and a particularly high failure rate for check dams.

Additional instream structures have since been added to Pipers Creek. The number of returning adult chum salmon in 1995 was greater than 100. Monitoring is expected to continue for several years to come, since project planners expect that macroinvertebrate populations will likely cycle up and down for a while. Consequently, fish populations are also expected to be variable until the system "settles down." In 1996, the Pipers

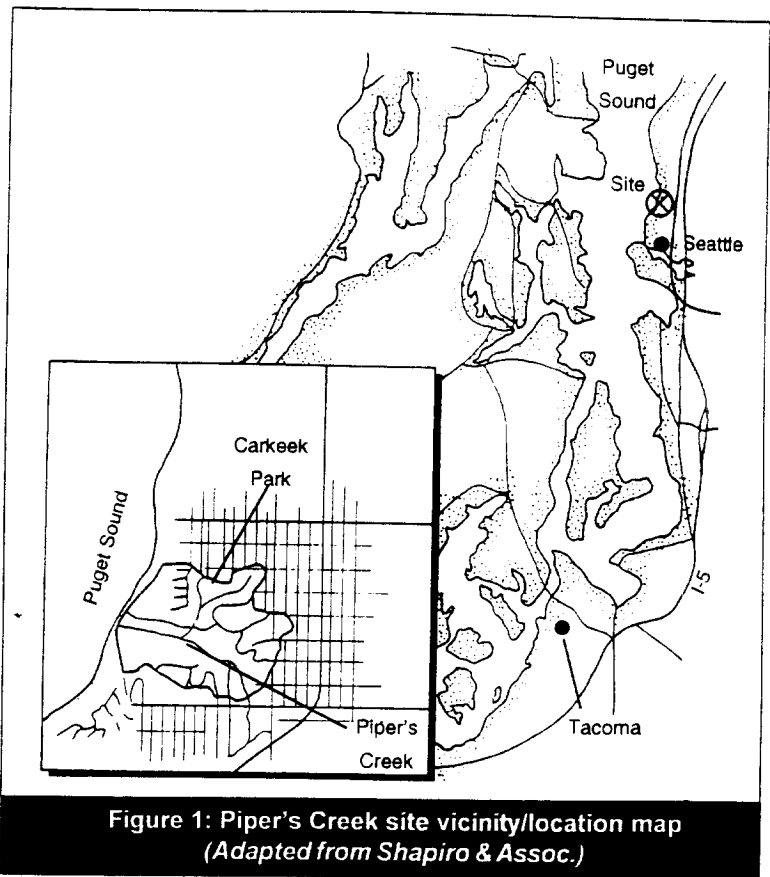

Figure 1: Piper's Creek site vicinity/location map  
(Adapted from Shapiro & Assoc.)

Creek approach will be applied to a tributary of Pipers Creek.

While the results from Pipers Creek are intriguing, there are still many questions to be answered about bottom-up stream restoration. To begin with, more data are needed on how long the instream habitat structures can withstand uncontrolled flows. One study of habitat structure failure rates (article 148) looked at fairly large streams subjected to high flows. Additional data from urban streams would be valuable. Second, will the bottom-up approach work well in other regions with other types of fish and is it practical if fish barriers exist? Finally, does bottom-up stream restoration benefit all indigenous fish species or only those that are more tolerant of urban stream conditions?

Some answers to this last question can be found in a 1986 study of urban fish communities in Washington. Scott and his colleagues found urban streams in Washington state had very different fish population dynamics, even where total biomass levels were similar. The impacted stream population consisted largely of young cutthroat trout, while the pristine stream had a population of diverse ages and species. Cutthroat trout, which have returned to Pipers Creek, appear to be less sensitive to the impacts of urbanization than are coho salmon and nonsalmonid fish (which have not returned to Pipers Creek.) In the urbanized stream, Scott found

**Table 2: Elements of Instream Restoration for Pipers Creek**

- **Vertical control of channel bottom**—rigid structures that prevent bottom scouring yet allow passage for large fish.
- **Bank protection at outside of bends**—boulders or logs hung over the bank and anchored in place; heavy plantings of bankside vegetation.
- **A tight meandering pattern for low flow**—deflectors of logs or rocks.
- **Step downs**—drops in elevation to form pools and riffles.
- **Define low flow path**—the end result of the above manipulations should be a low flow path that recurs after every storm event.

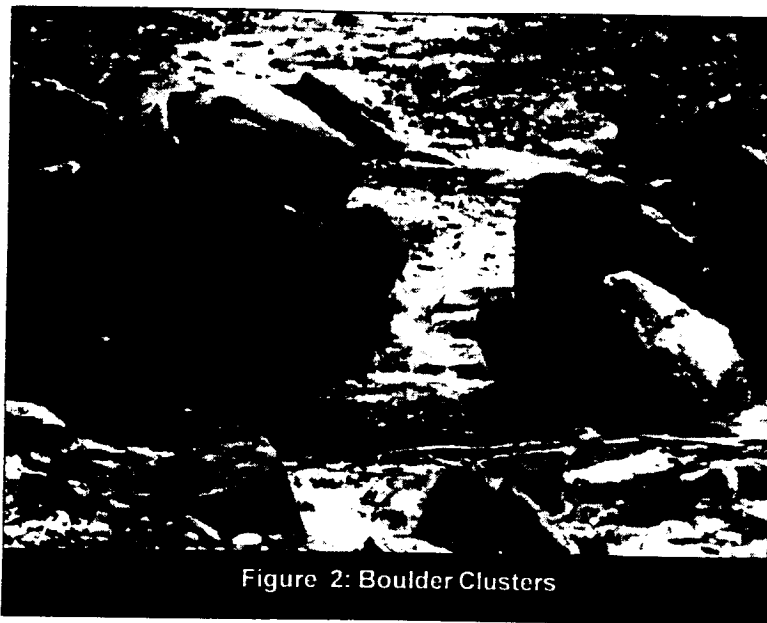

Figure 2: Boulder Clusters

**Table 3: Measures of Success at Pipers Creek**

Parameter	Before Project	After Project
Percent rocks with periphyton	0%	50%
Percent of stream area containing pools	16-17%	32%
Number of fish in upper reach	94	>800*
Number of returning adult chum salmon	None since 1975	>300 (1993-94); >100 (1995)

\* almost all cutthroat trout, nine months after project completion

nonsalmonids only, e.g., threespine sticklebacks, in the lower reaches of the stream.

In fact, Scott and colleagues found that the percentage of cutthroat trout in urban stream fish populations was directly related to the degree of imperviousness—the higher the level of imperviousness, the more cutthroat trout made up the community. Furthermore, chums (which have returned to Pipers Creek) spend a relatively short time in the stream; spawned in December-January, by June they are out in the ocean. In contrast, Coho salmon (which have not yet returned) usually live in the stream two years before migrating. Also, Cohos prefer pools 30 inches or more in depth, with a velocity of less than 0.5 cfs. In urban streams natural pools tend to fill with sediment and most of the techniques for recreating pools in streams produce turbulent flow to scour out the pool.

While it's probably impossible to restore fish populations in highly urbanized streams to pre-development conditions, the question remains: what is a reasonable restoration goal? It remains to be seen whether Coho salmon can ever be restored to urban streams. Still, following the progress of bottom-up stream restoration in Pipers Creek as it moves along the continuum from "damaged" to "healthy" will help in setting interim restoration goals. However, even if a habitat only approach proves effective, stormwater retrofit control may continue to be necessary for other reasons.

**References**

Gustav, R.S.; D.T. Sovern, and P.M. Washington. 1993. "If You Build It They Will Come: A Maintenance Approach to Restoring Fish Habitat in Urban Streams Heavily Influenced by Stormwater Flows." In: Water Environment Federation, *Proceedings of the Water Environment Federation 66th Annual Conference and Exposition*, Volume 7, Surface Water Quality & Ecology

Gustav, R.S. et al. 1994. "Maintaining Fish Habitat in Urban Streams." *Water Environ. Technol.* 48-53.

Scott, J.B. et al. 1986 "Effects of Urban Development on Fish Population Dynamics in Kelsey Creek, Washington." *Trans. Am. Fish. Soc.* 115:555-567.

# The Longevity of Instream Habitat Structures

Instream structures play a key role in urban stream restoration, as they recreate the pools, riffles, overhead cover and channel complexity that had been destroyed by increased stormwater flows. The same forces that degrade urban stream habitat—high flows, debris jams, and sedimentation—also work to lessen the effectiveness of artificial stream habitat structures. Therefore, a key question for urban stream managers is how long artificial habitat structures will persist before they too are damaged by urban stormwater flows. The question has enormous significance: is stream restoration a one-time intervention to reverse prior damage, or is it a constant struggle to try to maintain structure in streams that are dominated by erosive stormwater flows? If these structures fail, how often must they be replaced or repaired?

Urban stream restoration is such a new endeavor that we simply do not have enough of a track record to satisfactorily answer these questions. However, some insights into their longevity can be gleaned from an extensive study of the persistence of instream habitat structures in the Pacific Northwest conducted by Frissel and Nawa (1992). The researchers surveyed 161 fish habitat structures in 15 Oregon and Washington stream systems six months after a five- to 10-year flood event. The structures were one to five years old and were evaluated to determine how well they were functioning after the flood. The findings suggest that the expected longevity of structures is not as great as was once thought. In the 15 streams studied, more than half the structures had failed before the expected lifetime of 20 years. What's more, some of these "habitat improvement" structures had unintended and even negative effects on the stream morphology. For example, some had changed the course of the low-flow channel, or created barriers to fish migration rather than pools for breeding.

Are the observations from this large-scale study of undeveloped watersheds transferable to smaller, urbanized streams? It is important to remember that large and small streams differ in their vulnerability to physical forces (e.g., flood peak and sediment load) that damage structures.

## *The Causes of Structure Damage Are Multiple and Interacting*

Of the eight Oregon streams studied, wider streams did tend to experience greater peak flows and greater damage and failure rates of structures than narrower streams (Table 1). The relationship between channel width and failure rate appears to be linear. Channel width appears to be one stream characteristic correlated with failure rates in the Oregon streams studied. No other single stream characteristic was a useful predictor of future failure; indeed, failure rates were quite high and variable in most streams studied (Table 2).

Although stream variables other than channel width (e.g. valley type, drainage area, channel slope) were generally a poor predictor of longevity of instream habitat structures, structure type was correlated with failure rates. Some types of instream habitat structures appeared to be more susceptible to failure or impairment. The majority of cabled debris jams and boulder clusters remained functional after floods, whereas the majority of log-weirs failed or were impaired (Table 2). The durability of the materials themselves is not a great factor in structure performance; structures may still be in one piece but washed away whole or buried under sediments. Placement is a factor, in the sense that a structure may be well-placed to begin with but becomes ineffectual or deleterious if the stream channel shifts.

**Table 1: Active Channel Width and Structure Failure Rates (Frissel and Nawa, 1992)**

Stream name and no. of structures (n)	Width of active channel (ft)	Flood peak (cfs)	Damage rate (%)	Failure rate (%)
Outcrop (5)	18.0	247.2	40	40
Crooked Bridge (6)	19.7	423.7	100	100
Silver (6)	29.2	600.3	50	17
Foster (15)	31.5	1,059.3	27	7
Bear (19)	35.8	988.7	79	32
Boulder (5)	39.4	ND	60	40
Shasta Costa (18)	60.0	1,589.0	83	55
Euchre (19)	98.4	3,248.5	100	95



**Table 2: Performance of Eight Types of Instream Habitat Structures After a 5-10 Year Flood (Frissel and Nawa, 1992)**

Structure type	No. of structures	% working	% impaired	% failed
Cabled debris jam	19	75	10	15
Individual boulders	9	56	8	36
Boulder clusters	15	40	55	5
Multi-log structure	17	41	25	34
Transverse log weir	30	40	30	30
Diagonal log deflector	23	30	58	12
Lateral log weir	30	33	9	58
Downstream V log weir	12	0	52	48

"working" = remained functional; "impaired" = buried under sediment or damaged such that it was no longer functions as intended; "failed" = washed away or no longer in the channel

*"Habitat-improvement" Structures May Have Unintended and Adverse Effects on Stream Morphology*

Instream structures can have a negative impact on stream habitat quality in some cases. These impacts include habitat destruction during installation or deterioration of the structures; unforeseen changes in stream geometry that render a structure ineffective or deleterious; and unanticipated effects of the structure on the hydrology of a stream (e.g., boulders that were expected to scour out pools instead cause the creation of a midchannel gravel bar).

Some of the most common negative impacts of stream structures in Frissel and Nawa's study are:

- Accelerated bank erosion near log weirs
- Damage to riparian vegetation from heavy equipment during construction
- Overuse of streambank trees for construction material
- Streambank anchor-trees torn out along with the anchored devices during floods
- Gravel bars become larger and embedded with sand, resulting in loss of pool microhabitats

- Bed load triggered when structure fails, endangering nearby juvenile fish

*Can Observations Be Applied to Stream Restoration?*

Direct comparisons cannot be made between these large rivers of the Northwest (drainage area ranging from one to 200 sq. miles) and the typical small urban or suburban stream. Some key differences in size, discharge volume, and land use should be noted. First, the streams evaluated by Frissel and Nawa are much wider (average 40 feet) than typical urban headwater streams and consequently experience greater channel movement and changes in the streambed and banks. Second, the structures in this study are exposed to large, erosive floods (the February 1986 flood averaged 1,000 cfs in these mountain streams). Third, the streams studied by Frissel and Nawa were impacted by major logging disturbances (e.g., road-collapse and landslides from clear-cut slopes) that contributed to the sediment load.

While there are some sharp differences between small urban streams and the larger mountain systems studied here, urban streams are also subjected to high peak flows and the same basic principle could apply: the simpler the structure, the more likely it is to continue functioning after a large flood. On the other hand, the more elaborate structures, such as V-shaped weirs, make bigger changes to the stream hydrology and will be heavily impacted by floods. Stream habitat designers learn several lessons from this study:

1. The selection and placement of habitat structures should be fundamentally based on computed peak flows and velocities for the 10-year storm
2. Uncomplicated, low-profile structures will probably be the least impacted by the force of a flood
3. Structures perpendicular to streamflow (e.g., transverse log weirs) are fully exposed to undercutting and should be well anchored into the streambank.

—JMC

**Reference**

Frissel, C. A., and R. K. Nawa 1992. "Incidence and Causes of Physical Failure of Artificial Habitat Structures in Streams of Western Oregon and Washington." *N. Am. J. Fish. Manage.* 12(1): 182-197.

**Interacting Stream Characteristics That Bring About Physical Impacts on Instream Structures**

Stream Characteristics	Physical Impacts	Structure Performance
Width of active channel	Flood peak	Structure buried, broken or displaced
Channel slope	Land use	
Bank stability	Natural disturbance	
Regional precipitation	Valley type	
	Hydrological force	
	Channel movement	
	Sediment deposition	

# Stream Daylighting in Berkeley, CA Creek

by Prof. Vincent H. Resh, University of California—Berkeley

In the relatively new field of urban stream restoration, the nine-year-old Strawberry Creek project is valuable as a long-term case study, with extensive data collection. Table 1 shows the "prescription" for Strawberry Creek. Strawberry Creek has a 1,161 acre watershed (Figure 1) which begins in the canyons above the University of California-Berkeley campus (Figure 2) and is the focus of open space on campus. The creek then disappears into a pipe for most of its journey through the city of Berkeley until it enters central San Francisco Bay.

Strawberry Creek first began to suffer severe erosion in the late 1800s, as land around its headwaters was cleared for grazing. By the 1880s, check dams were built on campus to prevent further cutting of the streambed and bank erosion. As the watershed urbanized, Strawberry Creek began to suffer the full range of urban stream problems: continuing erosion and flooding, channelization and diversion, deteriorating water quality (because of sewage and illegal discharge, chemical contamination, and runoff), sediment contamination, and loss of pool-riffle sequences (Figure 3). These changes were manifested in a sharp loss of fish and insect diversity in Strawberry Creek. A 1987 stream assessment noted that 40% of the watershed was urban and the lag time between peak rainfall and peak runoff was only 15 to 20 minutes on the central campus.

Although Strawberry Creek is a heavily impacted urban stream, the University chose to actively pursue a goal of ecological restoration rather than merely attempting to prevent further degradation or merely improving the creek's aesthetic value. Pursuit of this goal was especially ambitious given that fish had been totally eliminated from the stream. Restoration elements to be addressed included water quality (both point and nonpoint pollutant sources, but not stormwater retrofits), biological communities and habitat, hydrologic conditions/erosion, and education and awareness. The ecological focus led to another unusual feature of the project: the reintroduction of nongame fish and salamanders. These elements are highlighted in Table 1. Finally, as might be expected, the Strawberry Creek project encountered problems that will be familiar to most stream restoration practitioners, including the need to coordinate among multiple institutions, a lack of funding, few possible stormwater retrofit sites, and difficulty with anchoring check dams.

## Prerestoration Conditions

A low-cost six-month study was undertaken in 1987 to draft a management plan and describe the creek's hydrology, water quality, and biological communities as well as its overall setting. An ambient water quality monitoring program was also put in place at this time. While water quality in the canyon areas upstream was similar to unimpacted streams in the region, downstream areas showed signs of nutrient enrichment and bacterial contamination (Table 2). Elevated levels of lead (> 50 ppm), zinc (150 ppm) and mercury (> 2 ppm) were found in stream sediments.

Like many urban streams, wet weather water quality was poor for chemical oxygen demand, suspended solids, nutrients, bacteria, and heavy metals. An outfall survey identified over 100 outfall pipes. Most were storm drain pipes, but some proved to be cooling water, direct discharges from campus buildings, or cross-connections to sanitary sewers. The survey concluded that illegal discharges and illicit connections were in fact contributing to the creek's water quality problems.

To assess the quality of the stream's biological communities, a number of monitoring studies were conducted and historical data were also reviewed. Steel-

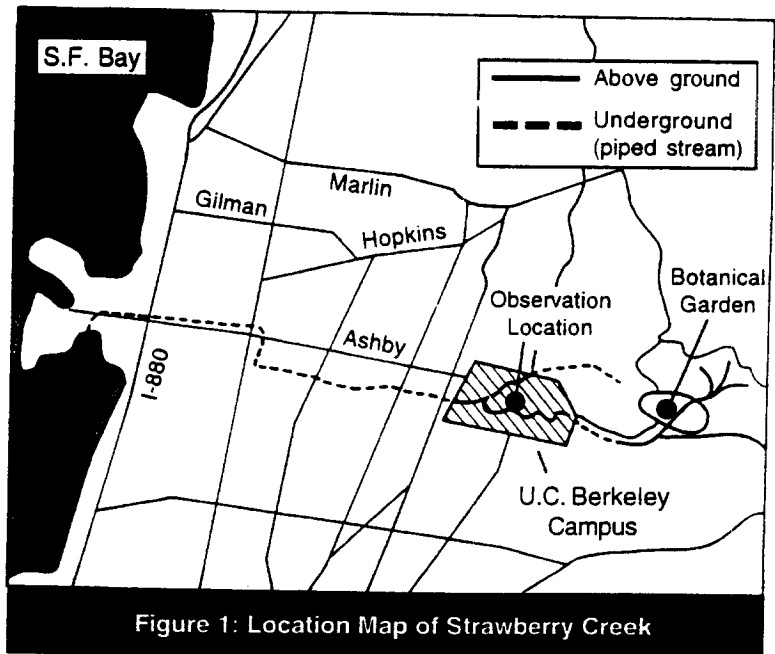

Figure 1: Location Map of Strawberry Creek

**Table 1: The Strawberry Creek "Prescription"**

Location: Berkeley, CA Watershed size: 1,161 acres Degree of Imperviousness: 50 percent	
Restoration Step	Application in Strawberry Creek
Control Urban Hydrologic Regime	
Remove Urban Pollutants	<ul style="list-style-type: none"> <li>■ Source control pollution prevention efforts (no stormwater retrofit)</li> <li>■ Elimination of illicit connections</li> </ul>
Restore Instream Habitat Structure	<ul style="list-style-type: none"> <li>■ Create pools/riffles</li> <li>■ Provide structural complexity</li> </ul>
Stabilize Channel Morphology	<ul style="list-style-type: none"> <li>■ Restore natural channel geometry</li> <li>■ Stabilize severe bank erosion</li> <li>■ Stabilize channel to accommodate bankfull discharge</li> </ul>
Replace / Augment Riparian Cover	
Protect Critical Stream Substrates	
Recolonize Stream Community	<ul style="list-style-type: none"> <li>■ Selectively reintroduce pre-disturbance native fish community</li> </ul>

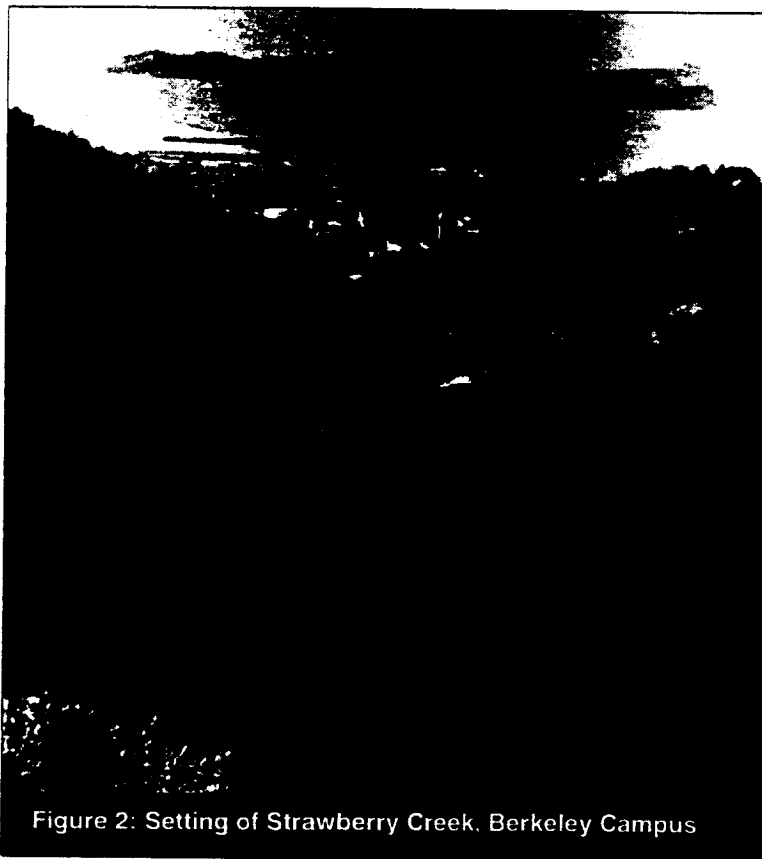

Figure 2: Setting of Strawberry Creek, Berkeley Campus

head salmon had not been seen in the campus reaches since the early 1930s, and in fact no species of fish were found in the stream reaches for decades. Regular surveys of aquatic macroinvertebrates typically showed five or less families of macroinvertebrates in the central campus reaches, as compared to the 15 to 20 families found upstream. In 1986 (the most sampling-intensive and site-extensive survey), 11 families, many of which are pollution tolerant, were collected on the campus. In contrast, 27 families (including many types usually found in unimpacted environments) were found in sections above the campus. Similarly, wildlife tolerant of urban environments (raccoon, opossum, and rodents) were found on the central campus, but the upper canyon contained many other mammals and bird species. Throughout the creek, the most abundant member of the periphyton (algae, fungi, and bacteria that attach to submerged surfaces) community was the alga *Cladophora glomerata*. This alga grows well in nutrient-enriched waters.

**Restoration Description and Findings**

The first priority was to eliminate point source discharges, cross-connections, and major sanitary sewer failures. This phase cost almost \$500,000 and took place from the fall of 1987 to the spring of 1989. Other projects during the same period included modifying garbage bin wash-down areas (to prevent runoff to the creek), sealing or removing abandoned pipes, and modifying backflushing practices at a large pool complex. In addition, staff was assigned to respond to reports of leaks, spills, and other pollutants (e.g. motor oil). To guard against future spills, floating booms were deployed where the creek entered the central campus. The booms also trapped floating trash and debris.

Stream restoration priorities included stabilization of banks and the stream bed. In one area where a bank was beginning to undercut an automobile bridge, the solution was to install a redwood crib wall (Figure 4). To protect the stream bed and improve pool-riffle ratios, a series of low check dams (Figure 5) were built. To allow for fish passage, the check dams extend no more than 45 cm from spillway to plunge pool. Existing check dams were also stabilized and repaired. A comparison of before and after creek channel profiles (1988 and 1990) revealed that sediment was being deposited behind most check dams. Some check dams showed signs of failure due to inadequate anchoring during construction. Erosion control projects in the creek's headwater canyons included gully repair, improved grading and maintenance of fire roads, and emergency diversion of runoff from heavy winter storms.

As shown in Table 2, most water quality parameters in the downstream reaches improved after the restoration project. Similarly, macroinvertebrate data also improved and the number of families is now close to values for upstream areas. Toxicity testing was conducted to

see if it was appropriate to reintroduce fish to the stream. Bioassays using water from the campus segment of the stream showed no acute or chronic effects. The first species selected for reintroduction was the three-spined stickleback: a hardy fish tolerant of frequent habitat disturbance. Several generations have successfully spawned in Strawberry Creek since their reintroduction. Additional fish species (roach, hitch and sucker) as well as the Turrice salamander have also been reintroduced to the creek. Crayfish have migrated to the restored reaches, and snowy egrets have returned to feed on fish in the creek.

Efforts to reduce pollution caused by dumping of unacceptable pollutants in storm drains in the Northside neighborhood of the City of Berkeley included a mailing to 1,000 residents and stormdrain stenciling. Also, the restoration project was successful in garnering press coverage by highlighting the return of fish to the creek after a 50-year absence. As a result, citizen reporting of pollution incidents increased dramatically. In fact, during a dye test of sewer lines, over 50 calls were received. As an indication of the creek's educational value to the University, over 2,500 students use the creek annually as part of their laboratory exercises in 50 different classes. In addition, an interpretive creekside trail has been developed for the portion of the creek that bisects the campus Botanical Garden; 13,000 copies of the booklet, *Strawberry Creek: A Walking Tour of Campus Natural History*, have been produced, and a centralized repository of creek information has been established on campus.

### Discussion

Combining several stream restoration steps, the Strawberry Creek project has made a significant difference. Where no fish were present, there are now self-sustaining fish populations. While the reintroduced fish are relatively tolerant species, they are nonetheless present in the stream year round. In addition, the successful salamander reintroduction and the return of crayfish and snowy egrets indicate a functioning stream community. However, it is too soon to tell if greater diversity (and the reintroduction of more sensitive species) can be achieved without additional restoration work.

In fact, many nonpoint source control programs are struggling with questions about whether voluntary source reduction efforts can be as effective as stormwater retrofits. The main problem now facing the continued success of restoration is the siltation resulting from extensive construction activities on the campus, and the failure of contractors to implement agreed-upon sediment and erosion controls in local construction sites. This is evident from biotic index scores for benthic macroinvertebrates that indicate a change from "good" conditions immediately after the restoration in 1991 to



Figure 3: Discharge Into Strawberry Creek at the Turn of the Century

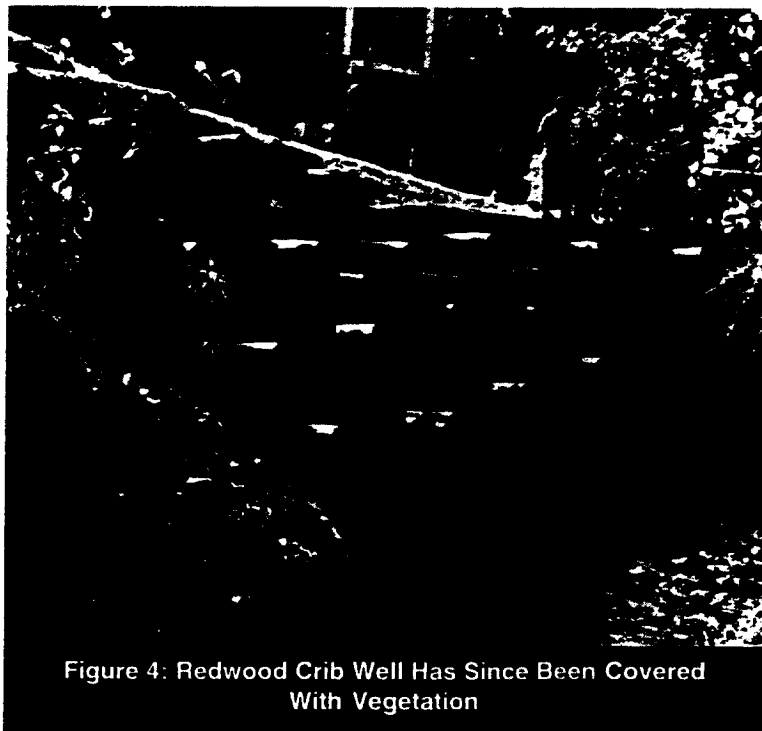

Figure 4: Redwood Crib Well Has Since Been Covered With Vegetation

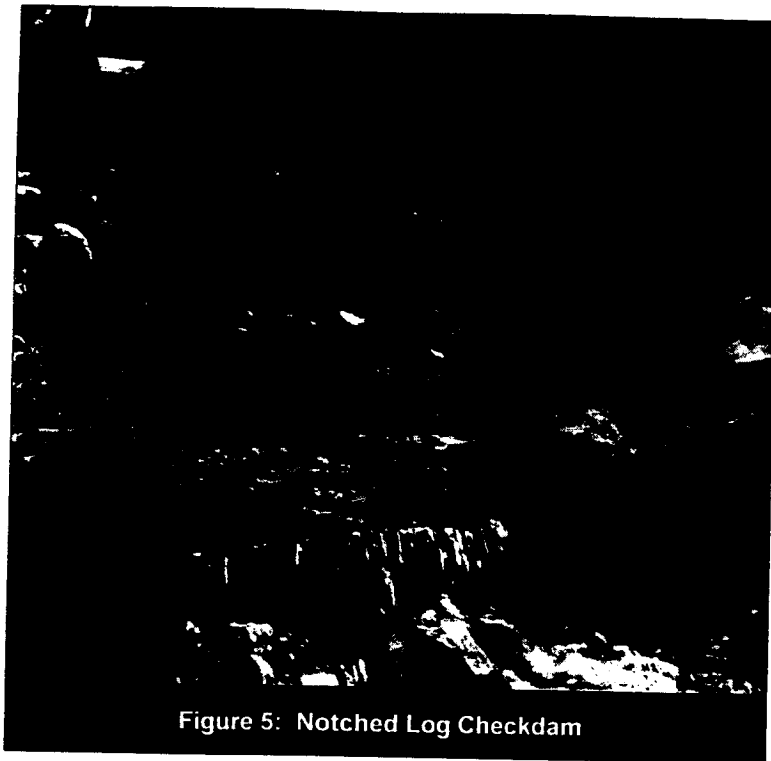

Figure 5: Notched Log Checkdam

Table 2: Strawberry Creek Central Campus Water Quality Data Before and After Restoration

Parameter	S. Fork (before)	S. Fork (after)	N. Fork (before)	N. Fork (after)
Chemical oxygen demand (mg/l)	13	10	<10	30
Dissolved solids (mg/l)	198	170	150	144
Suspended solids (mg/l)	2.9	2.0	12.8	4.0
Turbidity (NTU)	1.9	1.6	9.8	2.0
Oil and Grease (mg/l)	<1.7	ND	8.6	ND
Total Kjeldahl nitrogen (mg/l)	0.34	4.9	0.65	<1.4
Ammonia-nitrogen (NH <sub>3</sub> -N) (mg/l)	0.13	0.10	0.22	<0.1
Nitrate (NO <sub>3</sub> ) (mg/l)	2.0	1.7	3.6	1.3
Total phosphorus (mg/l)	0.24	0.14	0.34	0.19
Fecal coliform (MPN/100 ml)	11,000	5,000	34,500	1,400

“fair” conditions in 1993. This decrease in biological integrity underscores the need for continued vigilance and prevention of impacting activities following restoration. A reevaluation of the biological response to such stresses will be conducted in fall of 1995.

While seven years is a long time in the relatively new field of stream restoration, it's not a very long time period for observing stream responses. What will be the lifespan of the restoration techniques applied? So far, results are positive. Since 1989 the check dams have been subjected to several moderately severe storms (three 10-year events) without significant damage. The continuing monitoring of Strawberry Creek should prove of interest for years to come.

#### References

- Charbonneau, R. and Resh, V.H. 1992. "Strawberry Creek on the University of California, Berkeley Campus: A Case History of Urban Stream Restoration." *Aquatic Conserv.: Mar. Freshwater Ecosyst.* 2:293-307.

## Parallel Pipe Systems as a Stream Protection Technique

**B**low-out streams, channelization, rip rap, and eroded streambanks are all familiar conditions within the urban stream network. Recent stream enhancement activities have concentrated on bioengineering and instream habitat structures to correct past abuses and preserve existing conditions.

An alternative approach for some small headwater streams involves employing a parallel pipe storm drainage system (parallel to the natural stream channel), that conveys frequent storm flows past the existing natural channel, eventually discharging to a more stable downstream location. Parallel pipe systems are designed to maintain low flows within the existing stream channel, bypass the frequent erosive storms around sensitive portions of a stream, and allow large, less frequent storm events to remain within the stream channel or its floodplain.

This concept recognizes that urban streams are subject to flow events equaling bank-full conditions as often as three to five times per year or more, whereas

undeveloped natural streams may be subjected to bank-full flows once every other year or so (Hollis, 1975). These more frequent bankfull storms are thought to cause much of the stream channel erosion. In non-urbanized channels, more extreme storm events (i.e., greater than the 1.5- to two-year storm) spill over the banks and into the adjacent floodplain and are less erosive.

Parallel pipe systems have been installed for many reasons. For example, they can protect sensitive portions of natural stream channels, convey urban runoff to downstream stormwater management facilities, or aid in stabilizing the hydraulic regime of existing "blow-out" channels as part of stream protection efforts. Parallel pipe systems are appropriate for highly urbanized stream systems where bio-engineering techniques are not likely to withstand excessive erosive velocities, upstream stormwater management facilities are not feasible or practical, and structural stabilization with rip rap is not desired. In addition, parallel pipe system con-

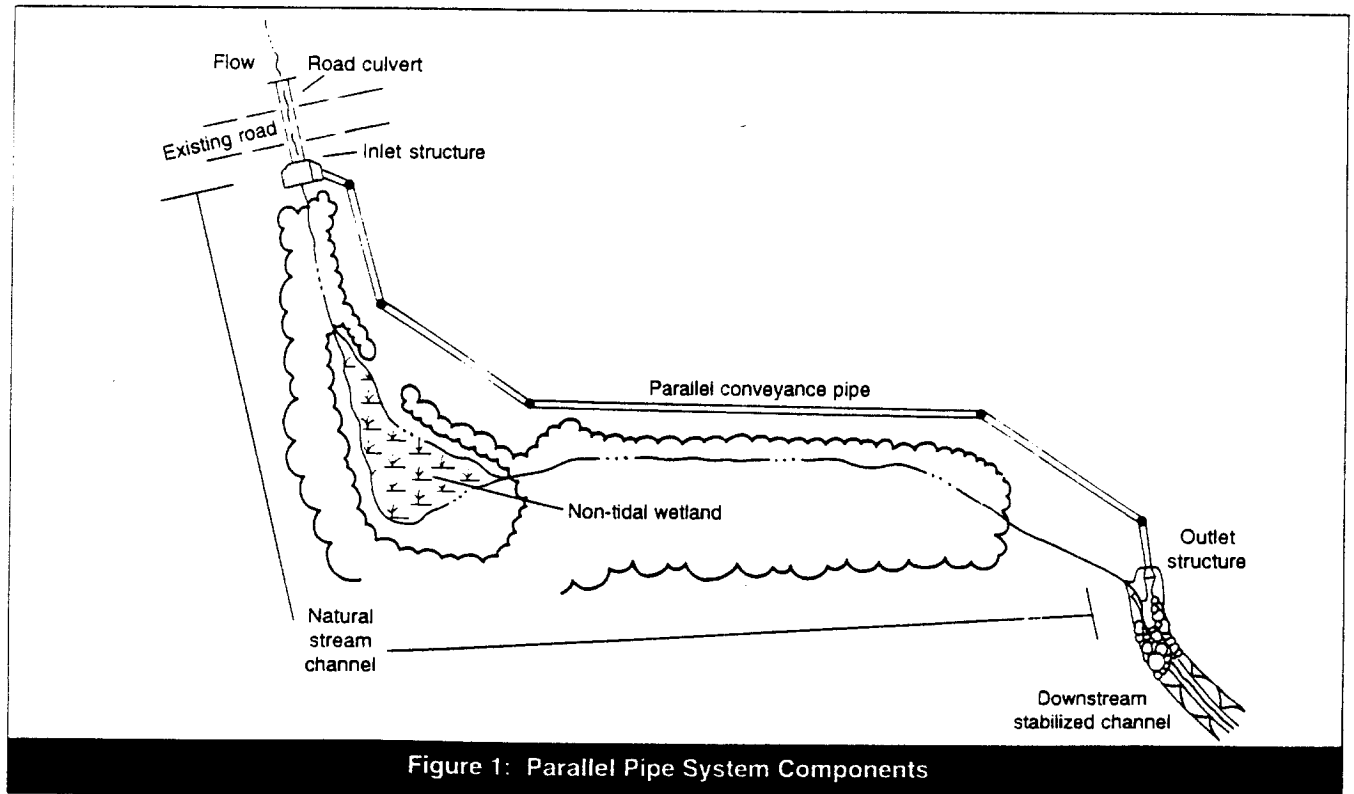

Figure 1: Parallel Pipe System Components

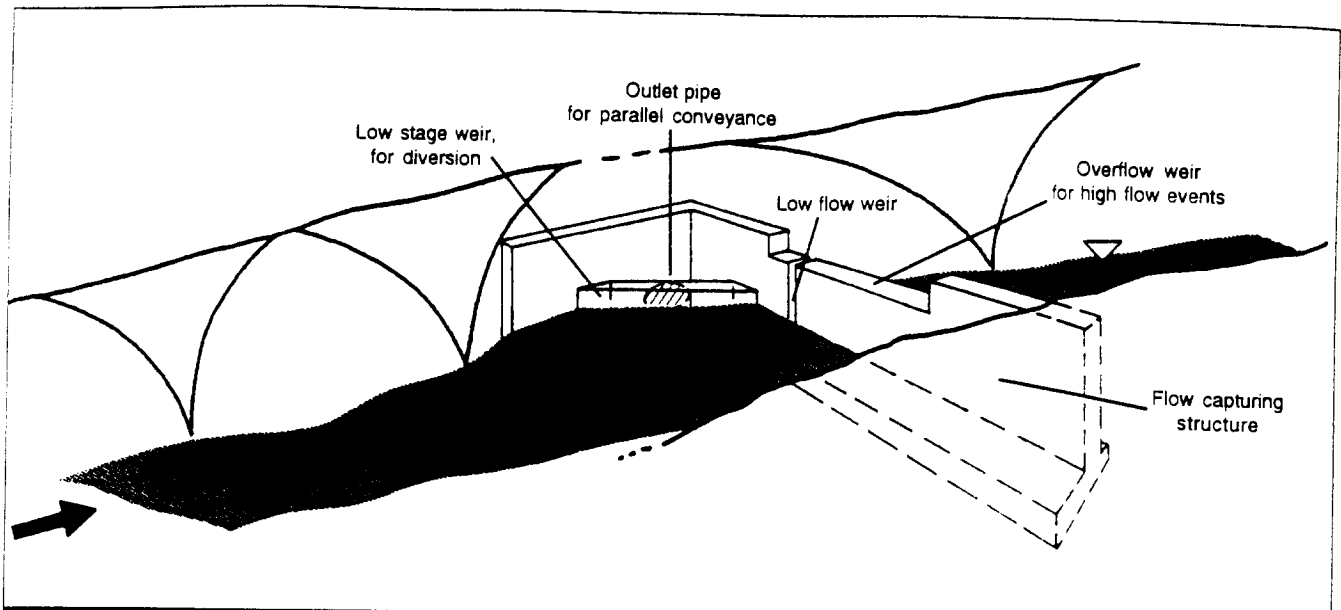

Figure 2: Parallel Pipe System Typical Inlet Structure

Table 1: Parallel Pipe Design Approach

1. Identify the stream reach to be protected
2. Field locate the control structure (detailed topography necessary)
3. Compute peak discharges for storm events
  - Design discharge for diversion (use storm for which 85% of all annual events are equal to or less than, i.e., 1.05" rainfall)\*
  - Large storm(s) for overflow weir (e.g., 10 to 100 year frequency event)
4. Field measure or compute baseflow discharge (1 cfs per square mile)\*\*
5. Calculate hydraulic characteristics of control structure
  - Use weir flow/orifice flow equations for baseflow
  - Use Federal Highway Administration culvert charts or computer model, for parallel pipe inlet flow condition
  - Use weir flow equation for high stage overflow
  - Use hydraulic model (e.g., HEC-2) for downstream tailwater analysis
  - Designer must recognize hydraulic losses at control structure intake
6. Compute required pipe size for parallel pipe system to pass design storm (use open channel flow equations, e.g., Manning's.)
7. Check hydraulic gradient for parallel pipe system under high flow conditions (usually 10 to 100 year storm)
8. Compute required outlet channel size (length and geometry)

\* Washington DC metropolitan area (50 year analysis at Washington National Airport)

\*\* Rule of thumb for Mid-Atlantic region

struction is often less disruptive than rechannelization and instream construction techniques. It is important to recognize that parallel pipe systems are most appropriate for small headwater streams where the small frequent storms can be adequately conveyed with reasonable pipe sizes and control structures are reasonably small in scale.

A parallel pipe system incorporates an inlet structure (flow splitter), a conveyance pipe or open channel, and an outlet or discharge structure (Figure 1). The inlet or control structure (usually cast-in-place concrete) is located at an upstream control point. It consists of a flow-capturing structure, a low-flow orifice or weir, a low stage weir for diversion of design flow rates, an outlet pipe for the parallel conveyance system, and an overflow weir for high-flow events discharging back into the natural channel (Figure 2). Large rip rap is usually required to guard against erosion at the control structure. The actual "parallel pipe" consists of a reinforced concrete pipe. The outlet channel or stilling basin should be stabilized and designed to conform to the natural channel geometry. Large rip rap or other suitable energy dissipation technique should be employed immediately below the outlet, but should be as short as possible and designed to return to the natural conditions quickly.

Table 1 outlines a general approach that can be used to design most parallel pipe applications. This approach is based on capturing a given frequency storm event for parallel conveyance. Further monitoring may suggest that an alternative storm frequency may be more appropriate for stream protection. Table 2 presents some key design tips that are often employed in parallel pipe projects. Designers must also assess the

potential costs of installing a parallel pipe system as opposed to alternative stream protection measures. As the drainage area increases, it becomes increasingly expensive to employ the parallel pipe application. Table 3 gives a sample drainage area versus cost comparison for moderately developed single family residential land use in the Mid-Atlantic region of the United States.

Parallel pipe systems can be installed in several locations within the urban drainage network (Figure 3). Common locations are:

- Existing or planned conventional storm drainage outfalls
- Within an existing or planned conventional storm drain manhole
- Immediately downstream of a road culvert
- Within the natural stream channel itself

#### Flora Lane - A Case Study

A parallel pipe system was constructed in 1993 adjacent to Flora Lane in Montgomery County, Maryland. The Flora Lane tributary to Sligo Creek drains a moderately developed area of approximately 235 acres. The parallel pipe system was constructed as part of the overall Sligo Creek restoration effort (see article 144), and was specifically targeted to protect approximately 750 linear feet of natural channel. The system consists of two upstream control points to collect stormwater from small storm events, a parallel pipe, and an outfall.

One method to assess the success of the project is through an ongoing physical, biological and chemical monitoring program. Biological monitoring was conducted for fish and macroinvertebrates prior to implementation of the project to help establish baseline conditions. Macroinvertebrate abundance was moderate to very low and only three native fish species were present (Stribling *et al.*, 1993). Nine native fish species were reintroduced into the stream in the spring of 1994, and, according to preliminary monitoring results, at least seven species were still present in the fall of 1994 (Galli, 1995).

It is probably too soon to assess the overall success of this project since far more monitoring needs to be performed, and it remains to be seen whether or not transplanted fish are reproducing on their own, but all preliminary indications point to parallel pipe systems as a viable though limited tool for stream restoration.

#### Construction Elements

Construction of parallel pipe systems are not significantly different from construction of conventional storm drain systems. However, extra attention must be given to the temporary diversion of flows (both base-

**Table 2: Some Key Design Issues for Parallel Pipes**

- Keep parallel pipe out of forested stream buffer, where possible
- Locate mature trees prior to laying out parallel pipe alignment
- Locate control structure to minimize secondary environmental impacts
- Reforest parallel pipe right-of-way after construction
- Use appropriate trash rack (or no trash rack) depending on litter/debris supply of watershed
- Consider fish migration barrier potential for spawning headwater streams
- Often requires a waterway construction permit or 404 non-tidal wetlands permit

**Table 3: Parallel Pipe Construction Cost Data**

Pipe size (RCP)	Maximum drainage area (acres)	Capacity (cfs)	Construction costs (\$/linear foot)
24"	40	22.6	\$40
36"	130	66.7	\$75
48"	300	143.6	\$105
60"	570	260.4	\$150
72"	1,000	423.4	\$235

Assumptions: Standard pipe sizes for reinforced concrete, maximum drainage area is based on single family residential land use (i.e., one-half acre lots), capacity is based on Manning's equation for reinforced concrete pipe at a 1.0% slope or steeper, construction cost includes installation, exclusive of control structure costs, and is based on approximate average installation costs for the Mid-Atlantic region from 1990 to 1994.

flow and storm flows) during construction of the control structure. It is also extremely important to have good quality control in constructing the weir and orifice elevations for any type of flow splitting device, as the slightest error can divert substantial amounts of water to the wrong location. A pre-construction meeting is imperative, and frequent inspections by the design engineer should be incorporated into the bidding specifications. The control structure formwork should be field surveyed prior to pouring concrete to ensure that the proper elevations and lengths have been achieved.



**A. Storm drain outfall**

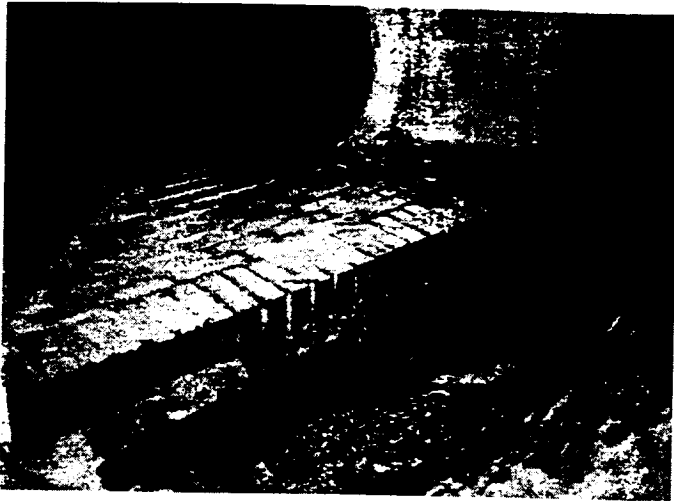

**B. Storm drain manhole (adapted from Loiederman Assoc., Inc.)**

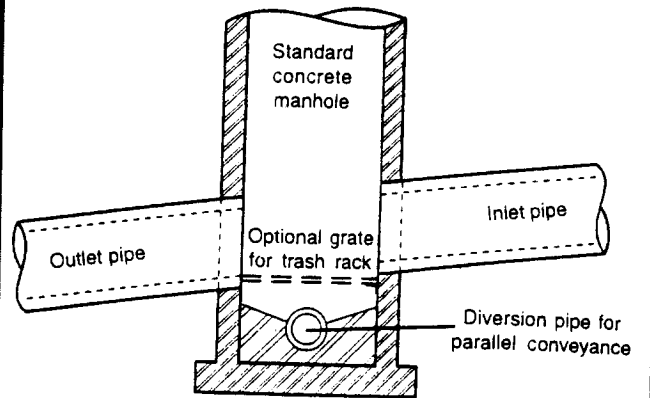

**C. Downstream from road culvert**

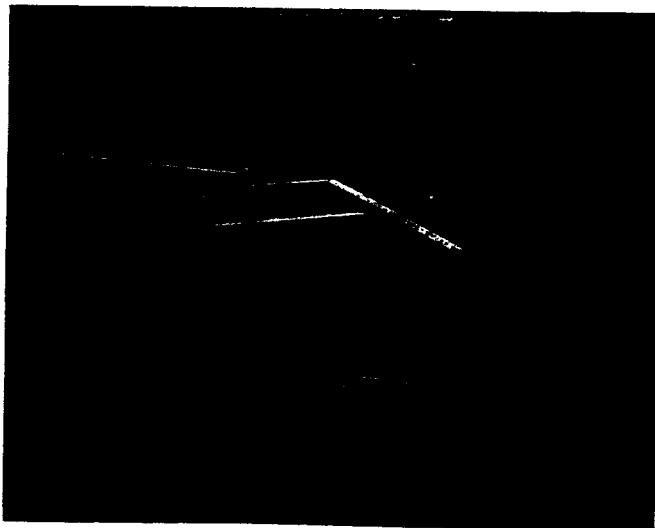

**D. Within natural stream channel**



Figure 3: Common Applications for Control Structure Location

### Clogging, Maintenance, Longevity and Safety

One of the primary concerns about parallel pipe systems is the susceptibility of the inlet structure to clogging. Accumulated trash, woody debris or sediment can potentially clog low flow openings and thus deprive the stream of necessary baseflows. A good solution is to provide a stilling basin immediately upstream of the control structure, and employ a hooded low flow orifice with a minimum diameter of three inches. The intake and outlet structures should be inspected at least twice a year and after major rainfall events to check for clogging. Trash racks and hooded openings may require cleaning on a more frequent basis. Based on local experience with modest drainage areas, stilling basins may require dredging every two to three years. The actual pipe system requires little maintenance as long as the intake does not clog and the system was initially constructed on a stable subgrade and backfilled properly.

Care should be employed to locate structures in areas where children are not likely to congregate. Trash racks and concrete structures can be an inviting play area to younger children. Fences are not desirable, since high flows are likely to wash them out. Warning signs might be considered where appropriate. Perhaps the best approach is to assume that children will be present, and use common sense in the design of reinforcing bars and concrete walls.

Parallel pipe systems can provide a cost-effective alternative to structural stabilization of small natural channels for urban areas. However, once the drainage area becomes reasonably large, and pipe sizes increase much above 54 inches, structural stabilization may be more cost effective (Table 3). Furthermore, it is important to realize that parallel pipes are not water quality treatment practices and do not attenuate stormwater runoff. If these systems are poorly designed, many of the problems they are designed to correct are simply moved downstream.

Parallel pipe systems have been used extensively in suburban Montgomery County, Maryland since 1987 and informal inspections indicate that they are protecting small stream channels. More formal monitoring reports indicate that urban streams protected by parallel pipes show minimal signs of continued channel erosion (Galli, 1995). Perceptions regarding clogging potential and maintenance appear to be the principal impediment to more widespread implementation. Some systems that have been in place for more than five years show signs of persistent clogging. Continued monitoring and review of design criteria are necessary to ensure that the practice is a reliable, long term stream protection measure. Additionally, research is needed to evaluate parallel pipe system design criteria to help define and establish the appropriate protection for small headwater streams.

—RAC

### References

- Galli, J. 1995. Personal communication. Department of Environmental Programs. Metropolitan Washington Council of Governments. Washington, DC.
- Hollis, G.E. 1975. "The Effect of Urbanization on Floods of Different Recurrence Interval." *Water Resour. Res.* Vol. 11, No. 3.
- Stribling, J.B., S.W. Lipham, and J. Cummins, 1993. *Monitoring Biological Responses to Stream Restoration Activities on Sligo Creek Watershed, Maryland*. Interim Report. Interstate Commission on the Potomac River Basin, Rockville, MD. Prepared for MWCOG, Washington, DC.



# Index

## by article number

### A

#### Aquatic Buffers, 27,30,39,40,41

- benefits of, 30, 39
- buffer "averaging", 39
- change in forest cover, 40
- concentrated vs sheet flow, 39
- costs, 30
- crossings, 39
- delineation of boundaries, 39,41
- education, 39
- effect on property values, 30
- encroachment, 39
- enforcement, 39
- model ordinances, 39, 41
- national survey of local buffer programs, 41
- recommended width, 39, 41
- three zone buffer system, 39, 41
- vegetative target, 39

#### Atmospheric Deposition, 6, 94

#### Arid Watersheds, 66

- differences from humid, 66
- preferred stormwater treatment practices, 66
- rainfall characteristics, 66
- stormwater quality, 66
- stormwater strategies for, 66

### B

#### Bacteria, 17,31,67,125

- bacteria management model, 31
- causes of mortality, 67
- design tips to improve bacteria removal, 67
- detecting sources, 3, 125
- dieoff rates, 67
- drinking water standards, 17,31
- dry weather sources, 31
- effectiveness of stormwater practices, 67
- effectiveness of buffers, 67
- effectiveness of source controls, 67
- field guide to, 17
- growth and survival, 17
- pathways, 17
- stormwater concentrations, 17
- sources in urban watersheds, 17
- water contact recreation standards, 17, 31
- wet weather sources, 31

#### Bankfull Flow, 19, 20

#### Beaver, 44

- biology and life history, 44
- control methods, 44
- damage in urban areas, 44
- effect on stream ecology, 44
- expanded range in North America, 44
- influence on riparian cover, 44

#### Better Site Design, 27,30, 45, 46,47,48,49,50

- benefits, 30, 45, 46, 47, 49
- codes and ordinance worksheet, 48
- costs savings, 45,46,47
- local site planning roundtables, 48, 50
- managing sprawl, 49
- open space subdivision design, 46,48
- green parking lot design, 45, 47, 48,50
- narrower residential streets, 45, 46, 48, 50
- sensible sidewalks, 45, 50
- shared parking, 45, 48, 50
- testing your local development rules, 48

#### Bio-accumulation, 1, 80,93,92

- in fish tissue, 11
- in crayfish tissue, 11
- In wetland plants, 83,92

### C

#### Channel Enlargement, 19, 20, 43, 63

- channel enlargement ratios, 19
- channel equilibrium, 19,20
- effect of development age in watershed, 19
- effect of riparian cover, 43
- lag time to ultimate enlargement, 19
- relationship to impervious cover, 19, 20
- stormwater management strategies, 19, 63
- stream narrowing, 43
- stream reaches vulnerable to erosion, 20

#### Channel Protection, 19, 20 63

- channel protection criteria, 19, 63

#### Chlorides, (see also road salt) 3, 38, 139

#### Clearing and Grading, 52,53,54

- checklist of improving local ordinances, 53
- clearing limits, 53
- construction phasing, 54
- inadequate revegetation, 53
- national survey of local clearing regs, 53
- site fingerprinting, 53

#### Cluster Development, (see open space development)

#### Cold Climate Watersheds, 3,38

#### Coliform Bacteria, 17

#### Compost, 37,109

- benefits of, 37
- selection of, 109
- soil amendments, 37
- specifications for, 37
- use as a filtering systems, 109

R0080193

- Conservation Areas, 27, 33, 34, 36
  - palustrine wetlands, 33
  - cedar swamps, 34
  - spaghnum bogs, 34
  - forests, 34
  - uncompacted soils, 36
- Conservation Easements, 27, 39
- Conservation Development (see open space design)
- Copper, 6,8
- Construction, 14,36,59
  - effect of clearing and grading on soils, 36
  - sediment concentrations in streams, 59
- Construction phasing, 52, 54,
  - principles for effective phasing, 54
  - reduction in sediment export, 54
  - sample phasing plan, 54
  - typical construction sequence, 54
- Construction site inspection, 52, 60, 61,62
  - blue card training program, 61
  - enforcement, 60,62
  - failure rate of practices, 60
  - field surveys, 60, 62
  - maintenance of practices, 60
  - preconstruction conference, 62
  - private inspection program, 61
  - steps to better inspection, 61
  - training inspectors, 61, 62
- Cost to implement, 30,37,52,54, 55,56, 68, 105, 106, 123, 124, 127, 139, 141, 142, 145, 146, 150
  - alternatives to road salting, 139
  - bioengineering, 145, 146
  - bioretention areas, 68
  - compost amendments, 37
  - constructing phasing, 54
  - created wetlands, 68
  - erosion and sediment control, 30, 52
  - filtering practices, 105, 106
  - parallel pipe systems, 150
  - recirculating sand filters, 125
  - septic systems, 123,124
  - silt fence, 56
  - stormwater treatment, 30,68
  - temporary stabilization, 55
  - watershed outreach, 127
  - watershed monitoring, 141
  - watershed restoration, 142
  - wet ponds, 68
- Created wetlands, 33, 64, 65, 67, 68, 71, 87 to 100
  - ED wetland, 89,90
  - pocket wetland, 94
  - shallow marsh, 88,91,92,93
  - pond-wetland systems, 88,91
  - submerged gravel wetlands, 95,96,97
  - arid climate design factors,
  - cold climate design factors, 71,88,95
  - cost considerations, 68
  - design guidelines, 95,98
  - environmental impacts, 79,88
    - bio-accumulation, 92
    - lake stratification, 88
    - stream warming, 88
  - harvesting and dredging, 92,97
  - landscaping, 90,98,99
  - longevity, 88, 89
  - maintenance, 88,92,96
  - mosquitos, 100
- Created Wetlands: Pollutant Removal
  - bacteria removal, 67, 96, 97
  - carbon removal, 88,71,90,96,97
  - comparative removal, 64,88
  - hydrocarbon removal, 96
  - irreducible concentrations, 65
  - lessons drawn from natural wetlands, 33,98
  - outflow concentrations, 88,91,94, 96
  - metal removal, 71,88,90,95,96,97
  - nutrient removal, 71,88, 89,90,91,93,94,95,96
  - nutrient removal dynamics, 88, 89,90,92,93,94,97
  - role of organic matter, 93,95
  - sediment removal, 71,88,89,90,91,94,95,96,97
  - effect of baseflow, 88
  - effect of storm-size, 90
  - effect of wetland age, 88
  - importance of detention time, 94,96
  - importance of gravel substrate, 97
  - importance of surface area, 97
  - importance of treatment volume, 90
  - wintertime performance, 88,95
  - sediment quality, 88, 92, 94
  - use of natural wetlands for stormwater treatment, 33
  - wetland plants, 89,90,91,98,99
    - below ground biomass, 89,92
    - optimal water depth, 98
    - invasive species, 89
    - change in wetland over time, 75,89,90
    - nutrient uptake, 91, 92
    - obtaining plant materials, 98,99
    - planting guidelines, 89,90,98
  - wildlife habitat, 91,99
- Cryptosporidium*, 17, 31
- D**
- Deicing Compounds, 3, 38, 139
- Density Compensation, 39
- Diazinon, 5,16, 133
- Dry-weather Flow (also baseflow), 10, 17, 125
  - bacteria level, 17, 125
  - detecting illicit discharges, 125
    - chemical tracers, 125
    - visual tests, 125
    - screening test, 31, 125,
  - flow response to urbanization, 10

## E

### Economic Benefits of Watershed Protection, 30

- aquatic buffers, 30, 39
- better site design, 30, 45, 46, 47
- conservation areas, 30
- erosion and sediment control, 14, 30
- green parking lots, 46
- managing sprawl, 49
- open space design, 46
- stormwater ponds, 30, 81, 84
- watershed planning, 30

### Erosion and Sediment Control,

14,27,30,36,52,53,54,57,58,60,61,62

- benefits, 30
- clearing and grading, 36, 53
- construction phasing, 54
- costs, 30
- elements of effective ESC plans, 52
- elements of effective ESC programs, 52
- enforcement, 52,60, 61, 62
- erosion and sediment control plans, 52
- inspection of construction sites, 60
- impacts of aquatic life, 14
- impact on soil compaction, 36
- maintenance of ESC practices, 52,60
- national survey of ESC practice, 52
- perimeter control, 52,56
- sediment basins (also traps), 52, 57, 58
- steep slope restrictions, 52
- temporary stabilization, 52

### Event Mean Concentration, 9, 12, 13

## F

### Fecal Coliform Bacteria, 17,31

### Filtering practices, 64, 105 to 111

- bioretention, 106, 110
- compost filters, 105, 106, 109
- multi-chamber treatment train, 111
- peat sand filters, 105, 106, 111
- perimeter sand filter, 105, 106, 107
- surface sand filter, 105, 106, 108
- underground sand filter, 105
- vertical sand filter, 105, 106

- arid climate design factors, 66, 106, 108
- cost considerations, 105, 109, 111
- design guidelines, 105, 106, 107, 110, 111
- feasibility, 105, 106, 107, 110
- importance of pretreatment, 108
- landscaping, 110
- longevity, 105, 106, 108
- maintenance, 105, 106, 107, 108, 109, 110
- sediment quality, 10, 80, 106

### Filtering Practice; Pollutant Removal,

- bacteria removal, 105, 106
- carbon removal, 105, 106, 107, 109, 111
- comparative removal, 64, 105, 106
- hydrocarbon removal, 105, 106, 109, 111

- irreducible concentrations, 65
- outflow concentrations, 106, 107, 111
- metal removal, 105, 106, 107, 109, 111
- nutrient removal, 105, 106, 107, 109, 111
- sediment removal, 105, 106, 107, 108, 109, 111
- basic filtering theory, 105, 106, 111
- importance of inflow concentration, 107

### First Flush, 9

### Flood plain Expansion, 63

### Freshwater Mussels, 14,25

## G

### Giardia, 17, 31

### Golf Courses, 82, 134, 135

- best management practices for, 134
- chemical application rates, 134
- design guidelines, 134
- impacts on riparian areas, 134
- nitrate leaching, 135
- pesticide detection, 135
- pesticide mobility, 135
- stormwater irrigation ponds, 82
- wildlife toxicity, 133

### Green Parking Lots, 45, 47

- benefits of, 45, 47
- costs, compared to standard parking lots, 47
- innovative parking codes, 47
- lower parking demand ratios, 45, 47
- redesign analysis, 47
- reduced impervious cover, 47
- reduced nutrient export, 47
- stormwater treatment options, 45, 47

### Groundwater Recharge, 10,63

- post-development recharge criteria, 63

## H

### Hydrocarbons, 2

### Hydrologic Soil Groups, 36

## I

### Impervious Cover, 18, 24, 25, 27, 28, 32

- effective impervious area, 32
- relationship to housing density, 25
- relationship to population density, 24,25
- relationship to road density, 18
- relationship to urban land use, 25
- techniques for estimating, 32
- use in watershed-based zoning, 27, 28

### Impervious Cover, Influence of,

1,9,10,11,13,18,19,20,21,22,  
23,24,25,26,28,33,34,40,75,79

- amphibian diversity, 33
- aquatic insects, 11, 18, 22, 26
- aquatic life, 11, 21

- aquifer, 28
- benthic organic matter, 24
- channel stability or enlargement, 18,19, 20
- coastal resources, 28
- drinking water quality, 28
- dry weather flow, 10, 26
- effect of watershed size, 25
- exotic fish species, 23,24
- feeding guilds, 23
- fish diversity, 11,18, 21,22,23,24,25
- first flush, 9
- intra-gravel dissolved oxygen, 18
- habitat, 18, 21
- hydrology, 18
- impervious cover model, 28
- lake quality, 28
- large woody debris (LWD), 18,20
- leaf pack decay rates, 24
- pollutant loads, 13
- riparian forest loss, 18, 40
- runoff, 1
- salmon habitat, 18
- sediment discharge, 19, 22,
- spaghnum moss, 34
- stream channels, 1
- stream temperature, 1, 75, 79
- stormwater quality, 1
- substrate quality, 22
- suspended solids, 26
- water quality (see runoff quality), 18,22
- wetland plant diversity, 33, 34
- wetland water quality, 1, 33
- wetland water level fluctuation, 33

**Infiltration Practices, 64, 66, 101,102,103,104**

- infiltration basin, 101,102,
- infiltration trench, 101
- porous pavement, 103
- arid climate design factors, 66
- benefits of, 103
- comparative pollutant removal, 64
- design guidelines, 101,102, 103
- effect of local water table, 102
- geotechnical testing, 101, 102, 103
- ground water interactions, 104
- importance of pretreatment, 101,102,103
- longevity (clogging), 101,102,103
- maintenance, 101,102, 103
- protection during construction process, 101
- risk of groundwater contamination, 104

- pollutants of greatest concern, 104
- risk assessment factors, 104
- hotspot restrictions, 104

**Illicit Discharges, 17, 125**

**Integrated Pest Management, 16, 130**

**L**

**Land Conservation, 27**

- benefits, 30
- effect on property values, 30
- tools for land conservation, 30
- types of conservation areas, 30

**Large Woody Debris (LWD), 18,20**

**Lawns, 4,5, 16, 33, 36, 37, 131,**

- change in lawns with age, 37
- compaction, 4, 36, 37
- compost amendments, 37
- nitrate leaching, 4, 131,
- nutrient cycle, 4
- pesticide concentrations in runoff, 5,16, 133
- phosphorus concentrations, 4,7
- runoff properties, 4
- toxicity to wildlife, 133

**Lawn Care, 129, 130, 131, 132**

- fertilizer applications, 129, 130, 131, 132
- grass selection, 130
- irrigation, 130
- lawn conversion, 130
- lawn restoration, 37
- low input lawns, 130
- over-watering, 131, 132
- pesticide applications, 130, 133
- soil building, 37, 130
- natural weed control, 130

**Lead, 6,8**

**Local Watershed Program Surveys, 29, 30, 39, 48, 49, 51, 52, 53, 69, 127**

- better site design, 48
- buffer programs, 39
- clearing and grading, 53
- codes and ordinance worksheet, 49
- erosion and sediment control, 52,62
- local program audits, 29
- open space design, 51
- stormwater utilities, 69
- watershed outreach, 127

**M**

**Maintenance, 27**

- maintenance of ESC practices, 52

**Meltwater (see snowmelt)**

**Monitoring (see also watershed indicators), 2,3,5 7,8, 9, 11, 12,13, 14, 15, 19,20,21,22,23, 24, 25, 31, 63, 85**

- bacterial sources, 31
- historical watershed comparisons, 23
- index of biotic integrity (IBI), 21,22, 24, 25
- indicators of pond quality, 85
- paired watershed study, 22
- rapid biological assessment, 21,24,25
- rapid channel assessment, 20
- reference stations, 22
- runoff quality, 2,3,5, 7, 8, 9,11,12,13,14,15,17,63
- stream channel enlargement, 19
- stream habitat quality, 21

**R0080196**

Mosquitos, 100

- designs guidelines, 100
- importance of fish, 100
- mosquito breeding conditions, 100
- safe mosquito controls, 100

## N

Nitrate-nitrogen (NO<sub>3</sub>), 4

- runoff concentration from lawns, 4

Non-Stormwater Discharges, 17, 27, 123, 124

- illicit discharges, 17
- septic systems, 17, 123, 124

## O

Oil-grit separators, 2, 119

- basic design, 2, 119
- cost considerations, 2
- design guidelines, 119
- maintenance and sediment disposal, 2, 119
- poor pollutant removal, 2, 119
- pool water quality, 2
- sediment quality, 2

Open Channel Practices, 64, 112 to 118

- biofilters, 112, 116, 117
- dry swale, 113, 116
- filter strip, 118
- grass swales or channels, 113, 114, 115, 116
- wet swales, 113, 116

- design guidelines, 112, 114, 116, 117, 118
- field survey on biofilter conditions, 112
- ground water interactions, 112, 113, 115
- landscaping, 112
- longevity, 112
- maintenance, 112

Open Channel Practices: Pollutant Removal,

- bacteria removal, 67, 116, 117
- carbon removal, 112, 113, 114, 116, 117
- comparative removal, 64, 116
- hydrocarbon removal, 112, 116, 117
- irreducible concentrations, 65
- outflow concentrations, 112, 113
- metal removal, 112 to 118
- nutrient removal, 112 to 118
- sediment removal, 112-114, 116- 118
- effect of detention time, 112, 115, 116, 117
- effect of filter strip length, 118
- effect of soil infiltration rate, 113, 114, 115
- effect of water table, 113

Open Space Design (also cluster or conservation design), 30,45,46,48,51

- benefits, compared to conventional design, 30, 46, 51
- design guidance, 46
- effect on property values, 30.
- infrastructure cost savings, 46
- national survey of local programs, 51
- open space management, 45, 48, 51

- open space targets, 46, 51
- recommended local criteria, 51
- redesign analysis, 46
- reduced impervious cover, 46
- reduced nutrient export, 46

Other Stormwater Treatment Practices, 119-122

- oil grit separators, 2, 119
- Stormceptor, 120
- street sweeping, 121
- storm drain inlet cleanouts, 122

Overbank Flooding, 63

## P

Parallel Pipe Systems, 150

- basic design, 150
- role in stormwater, 150
- role in stream protection, 150

Perimeter Control (aka silt fence), 52,56

- costs, 56
- factors diminishing sediment removal, 64
- innovative designs and anchors, 56
- silt fence, 56
- super silt fence, 56

Pervious Cover (see also lawns), 36, 37, 129

- high input turf, 129
- impact of construction on, 36, 129
- lawn restoration, 37
- peculiarities of, 129
- runoff response, 36, 129
- soil properties, 36
- types of pervious cover, 129

Pesticides, 5, 16, 133

- chlorpyrifos, 5,16, 133
- diazinon, 5,16, 133
- drift, 5,16
- herbicides, 5
- persistence in soils, 133
- pesticide pathways, 5, 133
- toxicity to wildlife, 16, 133

Polycyclic Aromatic Hydrocarbons (PAH), 2, 15

Pollution Prevention, 5, 136,137, 142

- guidelines for gas stations, 136
- guidelines for automotive repair shops, 136
- guidelines for residential areas, 142
- industrial sites, 137
- pollution prevention surveys, 142
- rooftop materials, 5

*Pseudonomas*, 17

R0080197



## R

### Retrofits, 142, 143

- common site constraints, 143
- examples of, 143
- feasibility of watershed restoration, 142
- optimal locations, 143
- pollution prevention surveys, 142
- priority subwatershed ranking, 142
- retrofit design, 143
- role in urban watershed restoration, 142
- stormwater retrofit inventory, 142, 143
- stream rehabilitation survey, 142
- types of stormwater retrofits, 143

### Resident Attitudes, 39,40,41,45,81,84,126, 127,130,131,138

- level of watershed awareness, 126, 138
- preferred media for learning about watersheds, 127
- rates of watershed behavior, 126
- resident surveys, 126, 127
- stream buffers, 39, 41
- towards better site design, 45
- towards lawns, 130, 131
- towards ponds and wetlands, 81,84,
- toward water quality, 138

### Riparian Reforestation, 42, 43

- beaver management, 44
- benefits of, 39, 43
- planting recommendations, 42
- survival rates, 42
- techniques for, 42
- use of tree shelters, 42

### Road Salting, 139

- alternative deicers, 139
- calcium magnesium acetate (CMA), 139
- impacts on aquatic environment, 139
- impacts on roadway vegetation, 139
- techniques to reduce salt impacts, 139

### Runoff Quality

- bacteria, 3, 7, 9, 15, 17,63
- carbon, 3, 7, 9,63
- chloride, 3,63
- event mean concentration, 9, 13
- first flush, 9
- hydrocarbons, 2,15
- metals, 3,7,9,12,15,63
- nutrients, 3,7,9,15,63
- suspended sediment, 7,14,63
- toxicity to aquatic life, 2,5,8,11,12,16

## S

### Salmon, 1, 18, 147

### Sediment Basins (also traps), 52, 57, 58,59

- factors influencing sedimentation, 59
- influence of particle size on settling rate, 57
- minimum detention time, 57,59

options for improving settling conditions, 58

- recommended design criteria, 58,59
- sediment removal, 57,58,59
- sedimentation theory, 57
- skimmer designs, 58
- standard design criteria, 58
- real word sediment removal, 57,59

### Semi-Arid Watersheds, 66

- differences from humid watersheds, 66
- preferred stormwater treatment practices, 66
- rainfall characteristics, 66
- stormwater quality, 66
- stormwater strategies for, 66

### Septic Systems, 17,30, 46, 123, 124

- alternative designs, 123
- bacteria treatment, 17, 123, 124
- costs, 30, 46, 123, 124
- effluent quality, 123, 124
- failure rates, 17, 123
- feasibility criteria, 123
- management districts, 123
- nitrogen discharge, 46, 123, 124
- recirculating sand filter, 124
- septic tank cleaning frequency, 123

### Soil Compaction, 36

- bulk density, 36
- root limiting growth, 36

### Sprawl Development Patterns, 1, 27,28,29,49

- economics of, 49
- impacts to environment, 1,49
- impact on landowners, 49
- impacts on local cost of services, 49
- impact on local tax base, 49
- growth management tools, 27,28,29, 49

### Snowmelt, 3

- hydrological impact, 3,
- melt process, 3
- runoff quality, 3
- management techniques, 3

### Source Area Monitoring, 6,7, 8, 15, 16, 17,

- auto recycling facilities, cars, 6
- commercial development lawns, 7, 15, 16, 17
- parking lots, 7,15
- residential, rooftops, 7, 8, 15
- streets, 7, 15
- wildlife, 17

### Steep Slope Restrictions, 52

### Stewardship (see watershed stewardship)

- Stormceptor,  
 basic design, 2, 120  
 cost considerations, 120  
 design guidelines, 120  
 effect of chlorides, 120  
 maintenance and sediment disposal, 120  
 poor pollutant removal, 120
- Storm drain inlet cleanouts, 122  
 cleanout and safe disposal, 122  
 pollutant concentrations, 122,  
 pool water quality, 122  
 potential pollutant reduction, 122  
 sediment quality, 122
- Stormwater Hotspots, 2, 15, 104, 136, 137, 140  
 auto recycling facilities, 140  
 auto repair shops, 136  
 gas stations, 2, 136  
 industrial sites, 137  
 pollution prevention practices for, 136, 137,  
 140
- Stormwater Treatment Practices, 27, 63 to 122  
 arid climate design factors, 66  
 benefits, 30, 63, 64  
 cold climate design factors,  
 comparative pollutant removal, 64  
 construction costs, 30, 68  
 as a function of impervious area  
 treated, 68  
 construction cost, 68  
 design and engineering cost, 68  
 economies of scale, 68  
 maintenance costs, 68  
 stormwater cost survey, 68  
 created wetlands, 33, 64, 65, 67, 71, 87 to  
 100  
 environmental impacts, 79, 80, 83, 104.  
 filtering practices, 64, 105 to 111  
 infiltration practices, 64, 101, 102, 103, 104,  
 irreducible concentrations, 65  
 national performance database, 64  
 open channel practices, 64, 112 to 118  
 other stormwater practices, 119 to 122  
 pollutant removal performance, 70 to 122  
 role of better site design, 45, 46, 47  
 sediment quality, 80  
 wet ponds, 64, 70 to 87
- Stormwater Utilities, 69  
 financing method, 69  
 functions of, 69  
 national utility survey, 69  
 public acceptance of, 69  
 steps to create utility, 69  
 trends in utilities, 69
- Stream Buffers, 18, 27, 30, 39, 41  
 acceptable uses, 41  
 beaver management, 44  
 benefits of, 18, 30, 39  
 buffer "averaging", 39  
 change in forest cover, 40  
 concentrated vs sheet flow, 39  
 costs, 30  
 crossings, 39  
 delineation of boundaries, 39, 41  
 education, 39  
 effect on large woody debris, 18  
 effect on property values, 30  
 encroachment, 39, 41  
 enforcement, 39  
 model ordinances, 39, 41  
 national survey of local programs, 41  
 recommended width, 39, 41  
 three zone buffer system, 39, 41  
 vegetative target, 39, 40
- Stream Order, 28
- Stream Restoration, 142, 144 to 150  
 bank stabilization, 144, 145, 146, 149  
 bioengineering, 145, 146  
 boulder clusters, 144, 147  
 case studies, 144 to 150  
 coconut rolls, 146  
 day lighting, 149  
 design considerations, 144, 146  
 fish reintroduction, 144, 147, 149  
 grade control, 147, 148, 149  
 instream habitat creation, 144, 147, 148, 149  
 imbricated rip-rap, 144  
 increased aquatic diversity, 144, 147, 149  
 log drop structures, 144, 148, 149  
 longevity of practices, 148  
 parallel pipes, 150  
 riparian reforestation, 144, 145, 149  
 rootwads, 144  
 salmon restoration, 147  
 source control, 147  
 step pools, 147  
 stormwater retrofits, 144  
 wing deflectors, 144, 147, 148
- Street Sweeping,  
 factors influencing sweeper efficiency, 121  
 potential sweeper effectiveness, 121  
 types of sweepers, 121  
 load reduction, 121
- Subwatersheds, 28, 29
- Suspended Sediment, 59
- T**  
 Temporary Stabilization, 52, 55  
 erosion reduction potential, 55  
 establishing vegetation, 55  
 materials for stabilization, 55  
 mulching alternatives, 55  
 techniques for challenging sites, 55
- Total Organic Carbon, 2

Total Phosphorus, 4, 7  
runoff concentration in lawns, 4, 7

Toxicity, 2,5,8, 11,12, 16,75,79,80,83,92,133

pesticide runoff from lawns, 5, 16  
risk of groundwater contamination, 104  
rooftop runoff, 5  
stormwater runoff, 11, 12  
stormwater hotspots, 2  
urban wildlife, 133  
wet pond sediments, 75,79,80,83  
wetland sediments, 92

## U

Urban Forests, 33, 34, 35, 40, 42

forest loss during urbanization, 40  
planting recommendations, 42  
sensitivity to inundation, 33, 34, 35  
sensitivity to road salting, 38  
survival rates, 42  
techniques for, 42  
use of tree shelters, 42

Urban Soils, 4, 36, 37

bulk density, 36  
compaction, 36  
compost amendments, 37  
effect of construction, 36  
hydrologic soil groups, 4, 36  
permeability, 4, 36  
runoff response, 4, 36

Urban Streams, 1, 5, 10, 11,12, 14,16,17,22, 24, 25,  
28, 31, 43, 129

aquatic insects, 43  
bacteria concentrations, 17  
baseflow, 10  
classification, 1, 28  
comparison to forested or agricultural  
streams, 22, 24  
effect of riparian cover, 18, 43  
impacted streams, 1, 28  
impacts of deposited sediments, 14  
Midwestern warm-water, 25  
non-supporting streams, 1,28  
pesticide concentrations, 5, 11,16, 129  
sediment quality, 11, 12, 16  
sensitive streams, 1, 28  
stream ecology, 43  
toxicity, 129  
turbidity, 14  
water contact recreation, 17  
use impairment, 31

## W

Water Quality Volume (WQv), 63

Watershed Advocacy, 27

Watershed Analysis, 22, 26, 40

geographic information systems (GIS), 40  
paired watershed studies, 22,26  
reference stations, 22

Watershed Based Zoning, 1,27,29

Watershed Behaviors, 4, 5, 6, 16, 27, 126, 129, 130,  
132

automotive fluid changing, 6, 126  
car washing, 126  
dog walking, 126  
lawn fertilization, 4, 126, 129, 130, 132  
lawn irrigation, 130  
pesticide application, 5, 16, 126, 129  
septic system maintenance, 126  
watershed ethic, 126

Watershed Education, 126, 127, 131, 136, 137, 138

basic awareness, 126, 138  
challenges of, 127  
crafting outreach messages, 127, 138  
effective outreach programs, 127, 138  
intensive training, 127,131, 136, 137  
media campaigns, 127  
pollution prevention for businesses, 136,  
137, 140  
preferred media for outreach, 127, 138

Watershed Indicators (see monitoring), 27,29, 141

biological indicators, 141  
methodology for choosing indicators, 141  
physical indicators, 141  
programmatic indicators, 141  
reference conditions, 141  
social indicators, 141  
site indicators, 141  
water quality indicators, 141

Watershed Planning, 1, 27,28,29, 30, 31

benefits, 30  
costs, 30  
effect on property values, 30  
basic concepts, 28  
impervious cover model, 1, 28  
influence of watershed scale, 28  
local program audits, 29  
mapping, 29  
reasons why plans fail, 29  
stakeholder involvement, 28, 29  
steps in watershed planning, 29  
strategies for bacteria management, 31  
stream order, 28  
subwatersheds, 28  
urban stream classification, 1,28  
watershed protection tools, 28  
watershed management units, 28

Watershed Management Structures, 27, 28, 29, 128

citizen directed model, 128  
government directed model, 128  
hybrid model, 128  
functions of, 29, 128  
stakeholder involvement, 29, 128

Watershed Models, 13,15, 46  
HSPF, 13  
SLAMM, 15  
SUNOM, 46  
SWMM, 13  
Simple Method, 13

Watershed Restoration (see stream restoration), 27

Watershed Stewardship, 27, 37  
lawn restoration, 37

Wetlands, 33, 34, 35, 38

cedar swamps, 34  
effect of buffers on natural wetlands, 33  
effect of road salting, 38  
flood tolerance of woody plants, 35  
forested floodplains, 35  
hydroperiod, 33  
influence of stormwater, 33, 34  
invasive species, 34  
palustrine wetlands, 33  
recommended tree species, 35  
salt tolerant species, 38  
sensitive bogs and fens, 33  
sphagnum bogs, 34  
water level fluctuations (WLF), 33  
watershed strategies for protection, 33

Wet Ponds, 64,65, 70 to 87

aquatic bench, 87  
dry pond, 84,86  
dry ED pond, 77,86  
multiple pond system, 78,  
pond-wetland system, 70, 71, 72, 75  
water reuse pond, 82  
wet pond, 73, 74,75,76,78, 81,84,85,87  
wet ED pond, 74,75  
amphibian habitat, 84  
cold climate design factors, 71,72,75  
cost considerations, 68, 81,84  
design guidelines, 73, 74,75,78  
dragonflies as indicator of pond quality, 85  
environmental impacts, 75,79, 80, 83

bio-accumulation, 80,83  
conversion of natural wetlands, 79  
downstream aquatic impacts, 79  
pond stratification, 79  
stream warming, 75,79  
techniques for minimizing, 79

golf course irrigation, 82  
ground water interactions, 78  
landscaping, 74,75,81,84,86,87  
longevity, 74,75  
sediment accumulation, 75  
maintenance, 74,80, 86  
mosquitos, 100

Wet Ponds: Pollutant Removal Performance,

bacteria removal, 67, 74,75,76  
carbon removal, 70,71,74,75,76,77,78  
chloride removal, 75  
comparative removal, 64,75

hydrocarbon removal, 74,75  
metal removal, 70,71,73,74,75,76,77,78  
nutrient removal, 70,71,73,74,75,76,77,78  
sediment removal, 70,71,73,74,75,76,77,78  
effect of baseflow, 72, 78  
effect of contributing watershed area, 73,76  
effect of detention time, 77  
effect of large storms, 77  
effect of pond volume, 73,74,75,78  
effect of waterfowl, 72,73  
irreducible concentrations, 65  
outflow concentrations, 73,74,75,78  
settling velocity in, 76,77  
wintertime performance, 71,75  
pond premium, 81,84  
pool stratification, 76  
regional stormwater ponds, 76  
resident attitude towards, 81,84  
sediment quality, 74,75,80,83

disposal methods, 80  
hydrocarbons, 80  
nutrients, 80  
macroinvertebrate community, 85  
metals, 80  
toxicity testing, 80

semi-arid climate design factors, 72,74  
trophic state, 76

## Z

Zeolites, 106

Zinc, 6,7,8

STATE OF CALIFORNIA  
CALIFORNIA REGIONAL WATER QUALITY CONTROL BOARD  
LOS ANGELES REGION  
320 WEST 4th ST., SUITE 200  
LOS ANGELES, CALIFORNIA 90013-2343

R0080202

---

# New York State Stormwater Management Design Manual

---

October 2001

Prepared by  
Center for Watershed Protection  
8391 Main Street  
Ellicott City, MD 21043

For:  
New York State  
Department of Environmental Conservation  
625 Broadway  
Albany, NY 12233



George E. Pataki, Governor    Erin M. Crotty, Commissioner

---

R0080203

## Table of Contents

Acknowledgments .....	i
Forward .....	ii
Preface .....	iii
<b>Chapter 1. Introduction</b>	
1.1 Purpose of the Manual .....	1-1
1.2 How to Use the Manual .....	1-1
1.3 Symbols and Acronyms .....	1-5
<b>Chapter 2. Impacts of New Development</b>	
2.1 Declining Water Quality .....	2-2
2.2 Diminishing Groundwater Recharge and Quality .....	2-7
2.3 Impacts to the Stream Channel .....	2-9
2.4 Increased Overbank Flooding .....	2-11
2.5 Floodplain Expansion .....	2-13
2.6 Impacts to Aquatic Organisms .....	2-14
<b>Chapter 3. Stormwater Permit Requirements</b>	
3.1 Applying for a Stormwater Permit .....	3-1
3.2 Filing Other Permit Applications .....	3-4
<b>Chapter 4. Unified Stormwater Sizing Criteria</b>	
4.1 Introduction .....	4-1
4.2 Water Quality Volume (WQv) .....	4-2
4.3 Stream Channel Protection Criteria (Cpv) .....	4-5
4.4 Overbank Flood Protection Criteria (Qp) .....	4-10
4.5 Extreme Flood Control Criteria (Qf) .....	4-12
4.6 Conveyance Criteria .....	4-14
4.7 Downstream Analysis .....	4-14
4.8 Stormwater Hotspots .....	4-16
<b>Chapter 5. List of Acceptable Stormwater Management Practices</b>	
5.1 Practice List .....	5-1
5.2 Structural Practices Acceptable for Pretreatment or as Supplemental Practices Only .....	5-4
5.3 Criteria for Practice Addition .....	5-4
<b>Chapter 6. Performance Criteria</b>	
6.1 Stormwater Ponds .....	6-3
6.2 Stormwater Wetlands .....	6-22
6.3 Stormwater Infiltration .....	6-31
6.4 Stormwater Filtering Systems .....	6-44
6.5 Open Channel Systems .....	6-59
<b>Chapter 7. SMP Selection Matrices</b>	
7.1 Land Use .....	7-3
7.2 Physical Feasibility Factors .....	7-5
7.3 Watershed/Regional Factors .....	7-7
7.4 Stormwater Management Capability .....	7-11
7.5 Community and Environmental Factors .....	7-13

**Chapter 8. Stormwater Design Example**

8.1	Sizing Example .....	8-2
8.2	Pond Design Example .....	8-11
8.3	Filter Design Example .....	8-27
8.4	Infiltration Design Example .....	8-36
8.5	Bioretention Design Example .....	8-42
References .....		R-1
Glossary .....		G-1

**Appendices**

A.	The Simple Method to Calculate Urban Stormwater Loads.....	A-1
B.	Hydrologic Analysis Tools .....	B-1
C.	SMP Construction Specifications .....	C-1
D.	Infiltration Testing Requirements.....	D-1
E.	Plan Review Checklist .....	E-1
F.	Construction Inspection Checklist.....	F-1
G.	Maintenance Inspection Checklists .....	G-1
H.	Landscaping Guidance/ Plant Lists .....	H-1
I.	Cold Climate Sizing Examples .....	I-1
J.	Geomorphic Assessment.....	J-1
K.	Miscellaneous Details .....	K-1
L.	Critical Erosive Velocities.....	L-1



**List of Tables**

Table 1.1 Key Symbols and Acronyms Cited in Manual .....	1-5
Table 2.1 National Median Concentrations for Chemical Constituents in Stormwater .....	2-3
Table 2.2 Runoff and Pollutant Characteristics of Snowmelt Stages.....	2-7
Table 2.3 Impacts to Stream Habitat.....	2-11
Table 2.4 Recent Research Examining the Relationship of Urbanization to Aquatic Habitat and Organisms .....	2-14
Table 3.1 Survey of Environmental Permits Issued by DEC that May Apply to New Development.....	3-6
Table 4.1 New York Stormwater Sizing Criteria .....	4-1
Table 4.2 Land Use and Impervious Cover .....	4-3
Table 4.3 Classification of Stormwater Hotspots .....	4-16
Table 5.1 Stormwater Management Practices Acceptable for Water Quality .....	5-3
Table 6.1 Water Quality Volume Distribution in Pond Designs .....	6-11
Table 6.2 Guidelines for Filter Strip Pretreatment Sizing .....	6-51
Table 7.1 Land Use Selection Matrix.....	7-4
Table 7.2 Physical Feasibility Matrix .....	7-6
Table 7.3a Watershed/Regional Selection Matrix-1 .....	7-8
Table 7.3b Watershed/Regional Selection Matrix-2 .....	7-10
Table 7.4 Stormwater Management Capability Matrix .....	7-12
Table 7.5 Community and Environmental Factors Matrix .....	7-14
Table 8.1 Summary of General Storage Requirements for Stone Hill Estates.....	8-11
Table 8.2 Summary of Controls Provided .....	8-22
Table 8.3 Site Hydrology .....	8-29
Table 8.4 Site Design Hydrology.....	8-37
Table 8.5 Site Specific Data.....	8-38
Table 8.6 Infiltration Feasibility .....	8-38
Table 8.7 Design Hydrology .....	8-43

**List of Figures**

Figure 2.1 Water Balance at a Developed and Undeveloped Site .....	2-1
Figure 2.2 Relationship Between Impervious Cover and Runoff Coefficient .....	2-2
Figure 2.3 Declining Baseflow in Response to Development.....	2-8
Figure 2.4 Increased Frequency of Erosive Velocities After Development .....	2-9
Figure 2.5 Relationship Between Impervious Cover and Channel Enlargement .....	2-10
Figure 2.6 Hydrographs Before and After Development.....	2-12
Figure 2.7 Floodplain Expansion with New Development.....	2-13
Figure 3.1 Stormwater Pollution Prevention Plan Component Requirements .....	3-3
Figure 3.2 New York State Regional Contact Information.....	3-11
Figure 4.1 90% Rainfall in New York State .....	4-2
Figure 4.2 Example of a Conventional Stormwater Detention Pond .....	4-7
Figure 4.3 Example of Stormwater Detention Provided by Underground Pipe System.....	4-8
Figure 4.4 One-Year Design Storm .....	4-9
Figure 4.5 10-Year Design Storm.....	4-11
Figure 4.6 100-Year Design Storm.....	4-13
Figure 4.7 2-Year Design Storm.....	4-15
Figure 6.1 Micropool Extended Detention Pond.....	6-4
Figure 6.2 Wet Pond.....	6-5
Figure 6.3 Wet Extended Detention Pond .....	6-6
Figure 6.4 Multiple Pond System.....	6-7
Figure 6.5 Pocket Pond.....	6-8

Figure 6.6 Seasonal Operation Pond .....	6-18
Figure 6.7 Shallow Wetland .....	6-23
Figure 6.8 Extended Detention Shallow Wetland .....	6-24
Figure 6.9 Pond/Wetland System .....	6-25
Figure 6.10 Pocket Wetland .....	6-26
Figure 6.11 Infiltration Trench .....	6-32
Figure 6.12 Infiltration Basin .....	6-33
Figure 6.13 Dry Well .....	6-34
Figure 6.14 Seasonal Operation Infiltration Facility .....	6-41
Figure 6.15 Surface Sand Filter .....	6-45
Figure 6.16 Underground Sand Filter .....	6-46
Figure 6.17 Perimeter Sand Filter .....	6-47
Figure 6.18 Organic Filter .....	6-48
Figure 6.19 Bioretention .....	6-49
Figure 6.20 Dry Swale .....	6-60
Figure 6.21 Wet Swale .....	6-61
Figure 7.1 Sole Source Aquifers in New York State .....	7-7
Figure 8.1 Stonehill Estates Site Plan .....	8-2
Figure 8.2 Stonehill Pre-Development Conditions .....	8-4
Figure 8.3 Stonehill Post-Development Conditions .....	8-5
Figure 8.4 Stonehill Ultimate Buildout Conditions .....	8-6
Figure 8.5 Detention Time vs. Discharge Ratios .....	8-7
Figure 8.6 Approximate Detention Basin Routing For Rainfall Types I, IA, II, and III .....	8-9
Figure 8.7 Pond Location on Site .....	8-13
Figure 8.8 Plan View of Pond Grading .....	8-14
Figure 8.9 Storage Elevation Table/Curve .....	8-15
Figure 8.10 Stage-Storage-Discharge Summary .....	8-20
Figure 8.11 TR-20 Model Input and Output .....	8-23
Figure 8.12 TR-20 Model Input and Output for Ultimate Buildout Conditions .....	8-25
Figure 8.13 Profile of Principle Spillway .....	8-26
Figure 8.14 Lake Center Site Plan .....	8-27
Figure 8.15 Available Head Diagram .....	8-30
Figure 8.16 Flow Diversion Structure .....	8-32
Figure 8.17 Plan and Profile of Surface Sand Filter .....	8-35
Figure 8.18 Lake Center Site Plan .....	8-36
Figure 8.19 Schematic Infiltration Trench Cross Section .....	8-41
Figure 8.20 Lake Center Site Plan .....	8-42
Figure 8.21 Typical Section of Bioretention Facility .....	8-45

## Acknowledgments

The New York State Stormwater Management Design Manual was prepared under a joint effort between the New York State Department of Environmental Conservation (DEC), the Soil and Water Conservation Committee, and the Central New York Regional Planning and Development Board. Several individuals at these organizations were instrumental in the process of completing this Manual. Don Lake provided the vision to initiate the process, and has been an integral part of its development. Shohreh Karimipour was also indispensable, providing detailed guidance throughout the process and acting as a liaison between the Center for Watershed Protection, the DEC, and several other agencies that commented on the manual. Thanks also to Mike Rafferty, Ken Stevens and Phil DeGaetano who shaped the final outcome of the manual, and provided valuable insight on its potential role in shaping the way stormwater management is conducted in the State of New York.

Additionally, several organizations and other individuals also took the time to review earlier versions of the manual and contributed to the production of this Manual.

Bob Alpern, New York City Dept. of Environmental Protection  
Pete Bartell  
Toni Cioffi, NYS DEC, DOW, Bureau of Water Permits  
Doreen Clemens, Saratoga County SWCD  
Thom Engel, NYS DEC, DEP  
Pat Ferracane, NYS DEC, Region 3  
Eugena Flatlow, NYC SWCD  
Matt Gillette, NYS DEC, Region 8  
Dave Graves, NYS DOT, Environmental Analysis Bureau  
Chad Kehoe, NYS DEC, Region 6  
Paul Kieda, NYS DOT  
Thilliyambur Manickam, NYS DEC, Region 9  
Paul Mankiewicz, Ph.D., GAIA Institute  
Robin Marx, Natural Resources Defense Council  
Tom McMahon, Suffolk County SWCD  
Mindy Moore, Westchester County SWCD  
Bill Morton, NYS DEC, DOW, Bureau of Watershed Management  
Bill Nechamen, NYS DEC, DOW, Bureau of Flood Protection  
Michael Patterson, Environment 21  
Paula Smith, Monroe County SWCD  
Thomas Snow, NYS DEC  
Don Stribick, Erie County SWCD  
Don Sweezy, NYS DOT, Region 6  
William Wegner, the Riverkeeper

And: the Urban Runoff Workgroup of the Non Point Source Coordinating Committee

## Forward

On November 16, 1990, the initial federal NPDES stormwater regulations were established. These required certain industrial activities to obtain permit authorization in order to discharge site runoff. DEC, as the NPDES permit issuing authority in this State, promulgated two SPDES general permits for stormwater runoff in 1993, GP-93-05 for the more traditional industrial sites and GP-93-06 for construction sites.

GP-93-06 requires that an operator who is covered under the permit implement a stormwater pollution prevention plan (SWPPP) that has been developed for the particular site. The minimum components of the SWPPP include a variety of requirements, including both structural and non-structural practices, inspections, contractor certifications, compliance with narrative water quality standards and other conditions. The attention, concern and efforts being directed at stormwater management practices at construction sites are constantly growing as new technologies emerge and experiences with older ones is gained. Additionally, construction site runoff is gaining wider attention as the federal NPDES stormwater program progresses. There is an ever-growing need to disseminate information concerning practices that are acceptable in New York.

The scope of attention is broadening on a national scale to smaller construction sites as evidenced by the Phase 2 stormwater regulations. Phase 2 lowers the threshold to one or more acres of disturbance, the runoff from which requires NPDES authorization for discharges to surface waters. Permitting will be required beginning on March 10, 2003. It's becoming more evident as time passes that there is a greater need for stormwater management practices that are technically effective and viable in New York State. "Spreading the word" to engineers, municipal officials, and the general public is crucial to the success of DEC's efforts in implementing the federal NPDES stormwater regulations and reducing incidences of water quality impairments.

Accordingly, permits that are issued in the future for construction site runoff will rely heavily on this new manual and the practices that are described therein. When properly designed and maintained, the implementation of these practices will become an important component of New York's overall stormwater management program. Adherence to the criteria and practices described will better ensure a successful implementation of stormwater controls and compliance with the SPDES general permit(s) issued for construction site runoff and maintaining water quality.



N. G. Kaul, P.E.  
Director  
Division of Water

## Preface

The New York State Stormwater Design Manual is prepared to provide standards for the design of the Stormwater Management Practices (SMPs) to protect the waters of the State of New York from the adverse impacts of urban stormwater runoff. This manual is intended to establish specifications and uniform criteria for the practices that are part of a Stormwater Pollution Prevention Plan (SWPPP).

This manual is intended primarily for engineers and other professionals who are engaged in the design of stormwater treatment facilities for new developments. Users are assumed to have a background in hydrology, hydraulics, and runoff and pollutant load computation. It is not intended to be a primer on any of these subjects. The manual may also be used by reviewing authorities to assess the adequacy of SWPPPs.

The manual is limited to the design of structures. It does not address the temporary control of sedimentation and erosion from construction activities, nor the development of Stormwater Pollution Prevention Plans. The reader is referred to the documents *“Reducing the Impacts of Runoff from New Development”* and *“New York State Guidelines for Urban Erosion and Sediment Control”* for guidance with these subjects.

Recommended Standards, consisting of proven technology, are intended to serve as a guide in the design and preparation of plans and specifications for Stormwater Management Practices, to suggest limiting values for items upon which an evaluation of such plans and specifications may be made by the reviewing authority, and to establish, as far as practicable, uniformity of practice. As statutory requirements and legal authority pertaining to stormwater management are not uniform across the State, and since conditions and administrative procedures and policies also differ, the use of these Standards must be adjusted to these variations.

The terms “shall” and “must” are used where the practice is sufficiently standardized to permit specific delineation of requirements or where safeguarding of the public health justifies such definite action. Other terms, such as “should,” “recommend,” and “preferred,” indicate desirable procedures or methods, with deviations subject to individual consideration.

# Chapter 1

Introduction

New York State Stormwater Management Design Manual

R0080211

## **Chapter 1: Introduction to the Manual**

### **Section 1.1 Purpose of the Manual**

The purpose of this manual is threefold:

1. To protect the waters of the State of New York from the adverse impacts of urban stormwater runoff
2. To provide design guidance on the most effective stormwater management practices (SMPs) for new development sites
3. To improve the quality of SMPs constructed in the State, specifically in regard to their performance, longevity, safety, ease of maintenance, community acceptance and environmental benefit

### **Section 1.2 How to Use the Manual**

The *New York State Stormwater Management Design Manual* provides designers a general overview on how to size, design, select and locate SMPs at a development site to comply with State stormwater performance standards. The manual also contains appendices with more detailed information on landscaping, SMP construction specifications, step-by-step SMP design examples and other assorted design tools. The manual is organized as follows:

#### **Chapter 2. Impacts of Stormwater Runoff**

This chapter examines the physical, chemical, and biological effects of unmanaged stormwater runoff on the water quality of local streams and waterbodies. This brief overview provides the background for why the stormwater management manual is needed and how the new criteria will help local communities meet water quality standards.

#### **Chapter 3. Permit Requirements**

This chapter explains the permitting process for stormwater management facilities, and what permits may be necessary to construct these facilities.

#### **Chapter 4. Sizing Criteria**

This chapter explains sizing criteria for water quality, channel protection, overbank flood control, and extreme flood management in the State of New York. The chapter also outlines the basis for design calculations.

### **Chapter 5. List of Practices**

This chapter briefly outlines the five groups of acceptable structural SMPs that can be used to meet water quality sizing criteria. The following are acceptable SMP groups:

- Stormwater Ponds
- Stormwater Wetlands
- Infiltration Practices
- Filtering Systems
- Open-Channel Practices

The chapter also explains the criteria for addition of a new practice to the list of acceptable SMPs, and provides fact sheets for some practices that are not on the list of practices, but can be used to provide supplemental treatment.

### **Chapter 6. Performance Criteria**

This chapter presents specific performance criteria and guidelines for the design of the five groups of structural SMPs. The performance criteria for each group of SMPs are based on six factors:

- Feasibility
- Conveyance
- Pretreatment
- Treatment
- Landscaping
- Maintenance

In addition, the chapter provides guidance on design adjustments that may be required to ensure proper functioning in cold climates.

### **Chapter 7. Guide to SMP Selection and Location**

This chapter presents guidance on how to select the best SMP or group of practices at a development site, as well as environmental and other factors to consider when actually locating each SMP. The chapter contains five comparative matrices that evaluate SMPs based on the following factors:

- Land Use
- Physical Feasibility
- Watershed /Regional Factors
- Stormwater Management Capability
- Community and Environmental Factors



Chapter 7 is designed so that the reader can use the matrices in a step-wise fashion to identify the most appropriate SMP or group of practices to use at a site.

## **Chapter 8. Design Examples**

Design examples are provided to help designers and plan reviewers better understand the new criteria in this manual. The step-by-step design examples demonstrate how the new stormwater sizing criteria are applied, and some of the design procedures and performance criteria that should be considered when planning a new stormwater management practice.

### *Stormwater Design Appendices*

The appendices contain the technical information needed to actually design, landscape and construct an SMP. There are a total of thirteen appendices:

#### **Appendix A. The Simple Method to Calculate Urban Stormwater Loads**

This appendix describes a fast and effective way to calculate stormwater runoff pollutant loads. Using impervious cover estimates based on land use, the Simple Method calculates annual runoff volume as a product of annual rainfall, and a runoff coefficient ( $R_v$ ). Annual runoff can then be combined with readily available stormwater pollutant concentrations to provide a quick estimate of annual pollutant loads. The appendix also discusses the limitations of the Simple Method.

#### **Appendix B. Design Tools**

The accurate calculation of stormwater flows may require modifications to some methods to account for small storm hydrology. This appendix provides methodologies to calculate the storage requirements for the channel protection flow event, and a methodology to calculate the peak flow from the small water quality storm.

#### **Appendix C. SMP Construction Specifications**

Good designs only work if careful attention is paid to proper construction techniques and materials. Appendix C contains detailed specifications for constructing ponds, infiltration practices, filters, bioretention areas and open channels.

**Appendix D. Infiltration Testing**

This appendix describes methodologies to test soil infiltration rates, in order to determine if infiltration is an acceptable option on site.

**Appendices E-G. Checklists**

These three appendices provide example checklists that can be used to assist in the plan review, construction, and operation and maintenance of an SMP.

**Appendix H. Landscaping Guidance**

Good landscaping can often be an important factor in the performance and community acceptance of stormwater SMPs. Appendix H also includes tips on how to establish more functional landscapes within stormwater SMPs, and contains an extensive list of trees, shrubs, ground covers, and wetland plants that can be used to develop an effective and diverse planting plan.

**Appendix I. Cold Climate Sizing Example**

This appendix supplies guidance on sizing SMPs to account for cold climate conditions that might hamper performance. Example sizing designs that illustrate how to incorporate cold climate criteria into SMP design are also included.

**Appendix J. Geomorphic Assessment**

This appendix provides a description of the Distributed Runoff Control (DRC) methodology to size stormwater practices based on downstream geomorphic characteristics.

**Appendix K. Miscellaneous Details**

The designs of various structures previously discussed in the manual are presented in Appendix K. These structures help enhance the performance of stormwater management practices, especially in cold climates. Schematics of structures such as weirs, trash racks, and observation wells are included.

**Appendix L. Critical Erosive Velocities**

This appendix provides data on critical erosive velocities for soil and grasses.

### Section 1.3 Symbols and Acronyms

As an aid to the reader, Table 1.1 outlines the symbols and acronyms that are used throughout the text. In addition, a glossary is provided at the end of this volume that defines the terminology used in the text.

Symbol	Definition	Symbol	Definition
<b>A</b>	drainage area	<b>Q<sub>f</sub></b>	extreme flood storage volume
<b>A<sub>r</sub></b>	filter bed area	<b>Q<sub>i</sub></b>	peak inflow discharge
<b>A<sub>s</sub></b>	surface area, sedimentation basin	<b>Q<sub>o</sub></b>	peak outflow discharge
<b>cfs</b>	cubic feet per second	<b>Q<sub>p</sub></b>	overbank flood control storage volume
<b>C<sub>p<sub>v</sub></sub></b>	channel protection storage volume	<b>q<sub>w</sub></b>	water quality peak discharge
<b>CMP</b>	corrugated metal pipe	<b>qu</b>	unit peak discharge
<b>CN</b>	curve number	<b>SMP</b>	stormwater management practice
<b>C<sub>p<sub>v</sub></sub>-ED</b>	extended detention of the 1 year post-development runoff	<b>R<sub>v</sub></b>	volumetric runoff coefficient
<b>d<sub>r</sub></b>	depth of filter bed	<b>R/W</b>	right of way
<b>du</b>	dwelling units	<b>SD</b>	separation distance
<b>DOT</b>	Department of Transportation	<b>SPDES</b>	State Pollutant Discharge Elimination System
<b>DPW</b>	Department of Public Works	<b>t<sub>c</sub></b>	time of concentration
<b>ED</b>	extended detention	<b>t<sub>t</sub></b>	time to drain filter bed
<b>f<sub>c</sub></b>	soil infiltration rate	<b>TR-20</b>	Technical Release No. 20 Project Formulation-Hydrology, computer program
<b>fps</b>	feet per second	<b>TR-55</b>	Technical Release No. 55 Urban Unit Hydrology for Small Watersheds
<b>h<sub>r</sub></b>	head above filter bed	<b>TSS</b>	total suspended solids
<b>HSG</b>	hydrologic soil group	<b>V<sub>r</sub></b>	volume of runoff
<b>I<sub>a</sub></b>	initial abstraction	<b>V<sub>s</sub></b>	volume of storage
<b>I</b>	percent impervious cover	<b>V<sub>t</sub></b>	total volume
<b>K</b>	coefficient of permeability	<b>V<sub>v</sub></b>	volume of voids
<b>NYSDEC</b>	New York State Department of Environmental Conservation	<b>WQ<sub>v</sub></b>	water quality storage volume
<b>NRCS</b>	Natural Resources Conservation Service	<b>WQ<sub>v</sub>-ED</b>	12 or 24 hour extended detention of the water quality volume
<b>P</b>	precipitation depth	<b>WSEL</b>	water surface elevation

# Chapter 2

## Impacts of New Development

New York State Stormwater Management Design Manual

R0080217

Urban development has a profound influence on the quality of New York's waters. To start, development dramatically alters the local hydrologic cycle (see Figure 2.1). The hydrology of a site changes during the initial clearing and grading that occur during construction. Trees that had intercepted rainfall are removed, and natural depressions that had temporarily ponded water are graded to a uniform slope. The spongy humus layer of the forest floor that had absorbed rainfall is scraped off, eroded or severely compacted. Having lost its natural storage capacity, a cleared and graded site can no longer prevent rainfall from being rapidly converted into stormwater runoff.

**Figure 2.1 Water Balance at a Developed and Undeveloped Site (Schueler, 1987)**

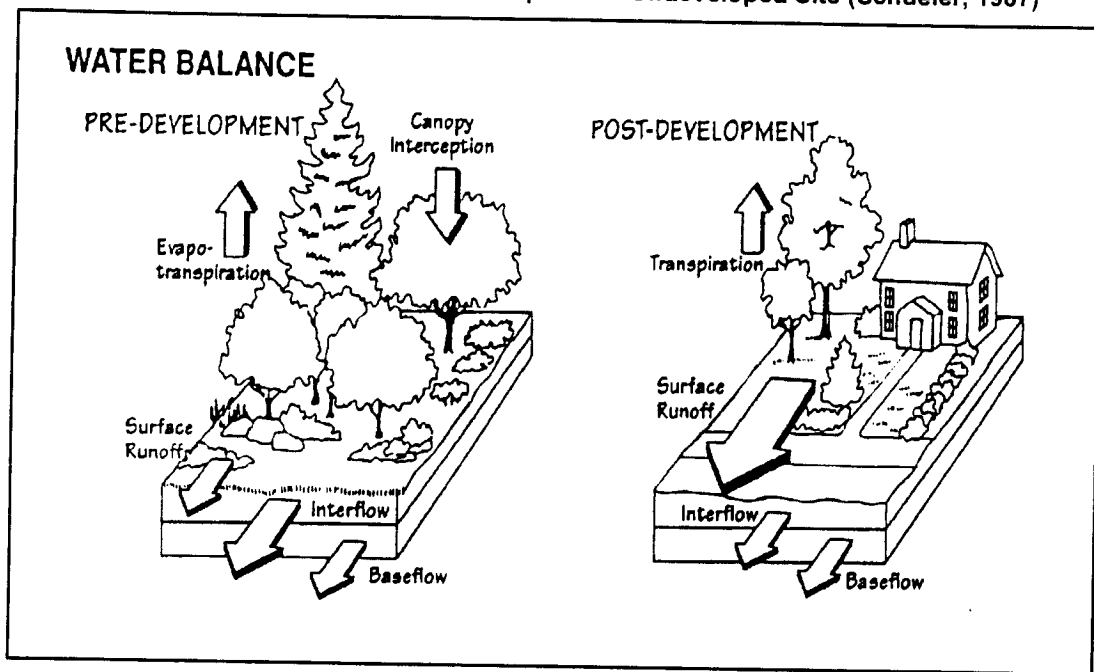

The situation worsens after construction. Rooftops, roads, parking lots, driveways and other impervious surfaces no longer allow rainfall to soak into the ground. Consequently, most rainfall is directly converted into stormwater runoff. This phenomenon is illustrated in Figure 2.2, which shows the increase in the volumetric runoff coefficient ( $R_v$ ) as a function of site imperviousness. The runoff coefficient expresses the fraction of rainfall volume that is converted into stormwater runoff. As can be seen, the volume of stormwater runoff increases sharply with impervious cover. For example, a one-acre parking lot can produce 16 times more stormwater runoff than a one-acre meadow each year (Schueler, 1994).

The increase in stormwater runoff can be too much for the existing drainage system to handle. As a result, the drainage system is often “improved” to rapidly collect runoff and quickly convey it away (using curb and gutter, enclosed storm sewers, and lined channels). The stormwater runoff is subsequently discharged to downstream waters, such as streams, reservoirs, lakes or estuaries.

**Figure 2.2 Relationship Between Impervious Cover and Runoff Coefficient (Schueler, 1987)**

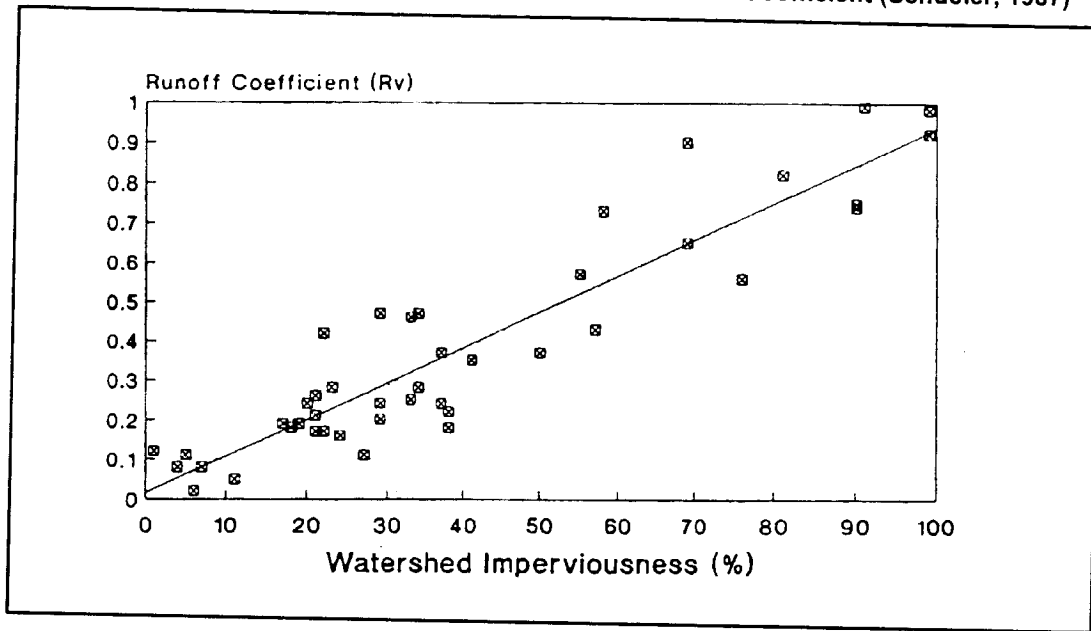

**Section 2.1 Declining Water Quality**

Impervious surfaces accumulate pollutants deposited from the atmosphere, leaked from vehicles, or windblown in from adjacent areas. During storm events, these pollutants quickly wash off, and are rapidly delivered to downstream waters. Some common pollutants found in urban stormwater runoff are profiled in Table 2.1.

Table 2.1 National Median Concentrations for Chemical Constituents in Stormwater		
Constituent	Units	Concentration
Total Suspended Solids <sup>1</sup>	mg/l	54.5
Total Phosphorus <sup>1</sup>	mg/l	0.26
Soluble Phosphorus <sup>1</sup>	mg/l	0.10
Total Nitrogen <sup>1</sup>	mg/l	2.00
Total Kjeldhal Nitrogen <sup>1</sup>	mg/l	1.47
Nitrite and Nitrate <sup>1</sup>	mg/l	0.53
Copper <sup>1</sup>	ug/l	11.1
Lead <sup>1</sup>	ug/l	50.7
Zinc <sup>1</sup>	ug/l	129
BOD <sup>1</sup>	mg/l	11.5
COD <sup>1</sup>	mg/l	44.7
Organic Carbon <sup>2</sup>	mg/l	11.9
PAH <sup>3</sup>	mg/l	3.5*
Oil and Grease <sup>4</sup>	mg/l	3.0*
Fecal Coliform <sup>5</sup>	col/100 ml	15,000*
Fecal Strep <sup>5</sup>	col/100 ml	35,400*
Chloride (snowmelt) <sup>6</sup>	mg/l	116

\* Represents a Mean Value  
 Source:  
 1: Pooled NURP/USGS (Smullen and Cave, 1998)  
 2: Derived from the National Pollutant Removal Database (Winer, 2000)  
 3: Rabanal and Grizzard 1995  
 4: Crunkilton *et al.* (1996)  
 5: Schueler (1999)  
 6: Oberts 1994

*Sediment (Suspended Solids)*

Sources of sediment include washoff of particles that are deposited on impervious surfaces and erosion from streambanks and construction sites. Streambank erosion is a particularly important source of sediment, and some studies suggest that streambank erosion accounts for up to 70% of the sediment load in urban watersheds (Trimble, 1997).

Both suspended and deposited sediments can have adverse effects on aquatic life in streams, lakes and estuaries. Turbidity resulting from sediment can reduce light penetration for submerged aquatic vegetation critical to estuary health. In addition, the reflected energy from light reflecting off of suspended sediment can increase water temperatures (Kundell and Rasmussen, 1995). Sediment can physically alter habitat by destroying the riffle-pool structure in stream systems, and smothering benthic organisms such as clams and mussels. Finally, sediment transports many other pollutants to the water resource.

*Nutrients*

Runoff from developed land has elevated concentrations of both phosphorus and nitrogen, which can enrich streams, lakes, reservoirs and estuaries. This process is known as eutrophication. Significant sources of nitrogen and phosphorus include fertilizer, atmospheric deposition, animal waste, organic matter, and stream bank erosion. Another nitrogen source is fossil fuel combustion from automobiles, power plants and industry. Data from the upper Midwest suggest that lawns are a significant contributor, with concentrations as much as four times higher than other land uses, such as streets, rooftops, or driveways (Steuer *et al.*, 1997; Waschbusch *et al.*, 2000; Bannerman *et al.*, 1993).

Nutrients are of particular concern in lakes and estuaries, and are a source of degradation in many of New York's waters. Nitrogen has contributed to hypoxia in the Long Island Sound, and is a key pollutant of concern in the New York Harbor and the Peconic Estuary. Phosphorus in runoff has impacted the quality of a number of New York natural lakes, including the Finger Lakes and Lake Champlain, which are susceptible to eutrophication from phosphorus loading. Phosphorus has been identified as a key parameter in the New York City Reservoir system. The New York City DEP recently developed water quality guidance values for phosphorus for City drinking water reservoirs (NYC DEP, 1999); a source-water phosphorus guidance value of 15 µg/l has been proposed for seven reservoirs (Kensico, Rondout, Ashokan, West Branch, New Croton, Croton Falls, and Cross River) in order to protect them from use-impairment due to eutrophication, with other reservoirs using the State recommended guidance value of 20 µg/l.



### *Organic Carbon*

Organic matter, washed from impervious surfaces during storms, can present a problem in slower moving downstream waters. Some sources include organic material blown onto the street surface, and attached to sediment from stream banks, or from bare soil. In addition, organic carbon is formed indirectly from algal growth within systems with high nutrient loads.

As organic matter decomposes, it can deplete dissolved oxygen in lakes and tidal waters. Declining levels of oxygen in the water can have an adverse impact on aquatic life. An additional concern is the formation of trihalomethane (THM), a carcinogenic disinfection by-product, due to the mixing of chlorine with water high in organic carbon. This is of particular importance in unfiltered water supplies, such as the New York City Reservoir System.

### *Bacteria*

Bacteria levels in stormwater runoff routinely exceed public health standards for water contact recreation. Some stormwater sources include pet waste and urban wildlife. Other sources in developed land include sanitary and combined sewer overflows, wastewater, and illicit connections to the storm drain system. Bacteria is a leading contaminant in many of New York's waters, and has led to shellfish bed closures in the New York Bight Area, on Long Island, and in the Hudson-Raritan Estuary. In addition, Suffolk, Nassau, and Erie Counties issue periodic bathing-beach advisories each time a significant rainfall event occurs (NRDC, 2000).

### *Hydrocarbons*

Vehicles leak oil and grease that contain a wide array of hydrocarbon compounds, some of which can be toxic to aquatic life at low concentrations. Sources are automotive, and some areas that produce runoff with high runoff concentrations include gas stations, commuter parking lots, convenience stores, residential parking areas, and streets (Schueler, 1994).

### *Trace Metals*

Cadmium, copper, lead and zinc are routinely found in stormwater runoff. Many of the sources are automotive. For example, one study suggests that 50% of the copper in Santa Clara, CA comes from brake pads (Woodward-Clyde, 1992). Other sources of metals include paints, road salts, and galvanized pipes.

These metals can be toxic to aquatic life at certain concentrations, and can also accumulate in the bottom sediments of lakes and estuaries. Specific concerns in aquatic systems include bioaccumulations in fish and macro-invertebrates, and the impact of toxic bottom sediments on bottom-dwelling species.

#### *Pesticides*

A modest number of currently used and recently banned insecticides and herbicides have been detected in urban and suburban streamflow at concentrations that approach or exceed toxicity thresholds for aquatic life. Key sources of pesticides include application to urban lawns and highway median and shoulder areas.

#### *Chlorides*

Salts that are applied to roads and parking lots in the winter months appear in stormwater runoff and meltwater at much higher concentrations than many freshwater organisms can tolerate. One study of four Adirondack streams found severe impacts to macroinvertebrate species attributed to chlorides (Demers and Sage, 1990). In addition to the direct toxic effects, chlorides can impact lake systems by altering their mixing cycle. In 1986, incomplete mixing in the Irondequoit Bay was attributed to high salt use in the region (MCEMC, 1987). A primary source of chlorides in New York State, particularly in the State's northern regions, is salt applied to road surfaces as a deicer.

#### *Thermal Impacts*

Runoff from impervious surfaces may increase temperature in receiving waters, adversely impacting aquatic organisms that require cold and cool water conditions (e.g., trout). Data suggest that increasing development can increase stream temperatures by between five and twelve degrees Fahrenheit, and that the increase is related to the level of impervious cover in the drainage area (Galli, 1991). Thermal impacts are a serious concern in trout waters, where cold temperatures are critical to species survival.

#### *Trash and Debris*

Considerable quantities of trash and debris are washed through the storm drain networks. The trash and debris accumulate in streams and lakes and detract from their natural beauty. Depending on the type of trash, this material may also lead to increased organic matter or toxic contaminants in water bodies.

#### *Snowmelt Concentrations*

The snow pack can store hydrocarbons, oil and grease, chlorides, sediment, and nutrients. In cold regions, the pollutant load during snowmelt can be significant, and chemical traits of snowmelt change over the

course of the melt event. Oberts (1994) studied this phenomenon, and describes four types of snowmelt runoff (Table 2.2). Oberts and others have reported that 90% of the hydrocarbon load from snowmelt occurs during the last 10% of the event. From a practical standpoint, the high hydrocarbon loads experienced toward the end of the season suggest that stormwater management practices should be designed to capture as much of the snowmelt event as possible.

<b>Snowmelt Stage</b>	<b>Duration/Frequency</b>	<b>Runoff Volume</b>	<b>Pollutant Characteristics</b>
Pavement Melt	Short, but many times in winter	Low	Acidic, high concentrations of soluble pollutants, Cl, nitrate, lead. Total load is minimal.
Roadside Melt	Moderate	Moderate	Moderate concentrations of both soluble and particulate pollutants.
Pervious Area Melt	Gradual, often most at end of season	High	Dilute concentrations of soluble pollutants, moderate to high concentrations of particulate pollutants, depending on flow.
Rain-on-Snow Melt	Short	Extreme	High concentrations of particulate pollutants, moderate to high concentrations of soluble pollutants. High total load.

**Section 2.2 Diminishing Groundwater Recharge and Quality**

The slow infiltration of rainfall through the soil layer is essential for replenishing groundwater. Groundwater is a critical water resource across the State. Not only do many residents depend on groundwater for their drinking water, but the health of many aquatic systems is also dependent on its steady discharge. For example, during periods of dry weather, groundwater sustains flows in streams and helps to maintain the hydrology of non-tidal wetlands.

Because development creates impervious surfaces that prevent natural recharge, a net decrease in groundwater recharge rates can be expected in urban watersheds. Thus, during prolonged periods of dry weather, streamflow sharply diminishes. Another source of diminishing baseflow is well drawdowns as populations increase in the watershed. In smaller headwater streams, the decline in stream flow can cause a perennial stream to become seasonally dry. One study in Long Island suggests that the supply of

baseflow decreased in some developing watersheds, particularly where the water supply was sewered (Spinello and Simmons, 1992; Figure 2.3).

Urban land uses and activities can also degrade *groundwater quality*, if stormwater runoff is infiltrated without adequate treatment. Certain land uses and activities are known to produce higher loads of metals and toxic chemicals and are designated as *stormwater hotspots*. Soluble pollutants, such as chloride, nitrate, copper, dissolved solids and some polycyclic aromatic hydrocarbons (PAH's) can migrate into groundwater and potentially contaminate wells. Stormwater runoff from designated hotspots should never be infiltrated, unless the runoff receives full pretreatment with another practice.

Figure 2.3 Declining Baseflow in Response to Development

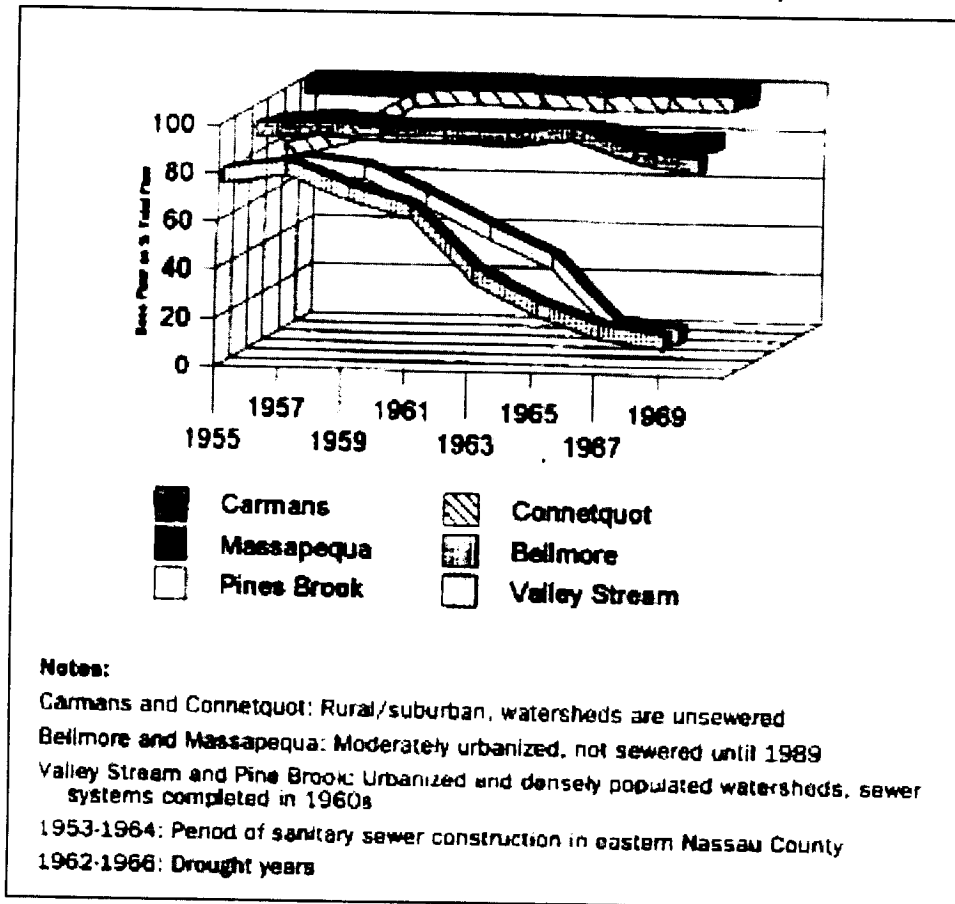

**Section 2.3 Impacts to the Stream Channel**

As pervious meadows and forests are converted into less pervious urban soils, or pavement, both the frequency and magnitude of storm flows increase dramatically. As a result, the bankfull event occurs two to seven times more frequently after development occurs (Leopold, 1994). In addition, the discharge associated with the original bankfull storm event can increase by up to five times (Hollis, 1975). As Figure 2.4 demonstrates, the total flow beyond the “critical erosive velocity” increases substantially after development occurs. The increased energy resulting from these more frequent bankfull flow events results in erosion and enlargement of the stream channel, and consequent habitat degradation.

**Figure 2.4 Increased Frequency of Erosive Velocities After Development**

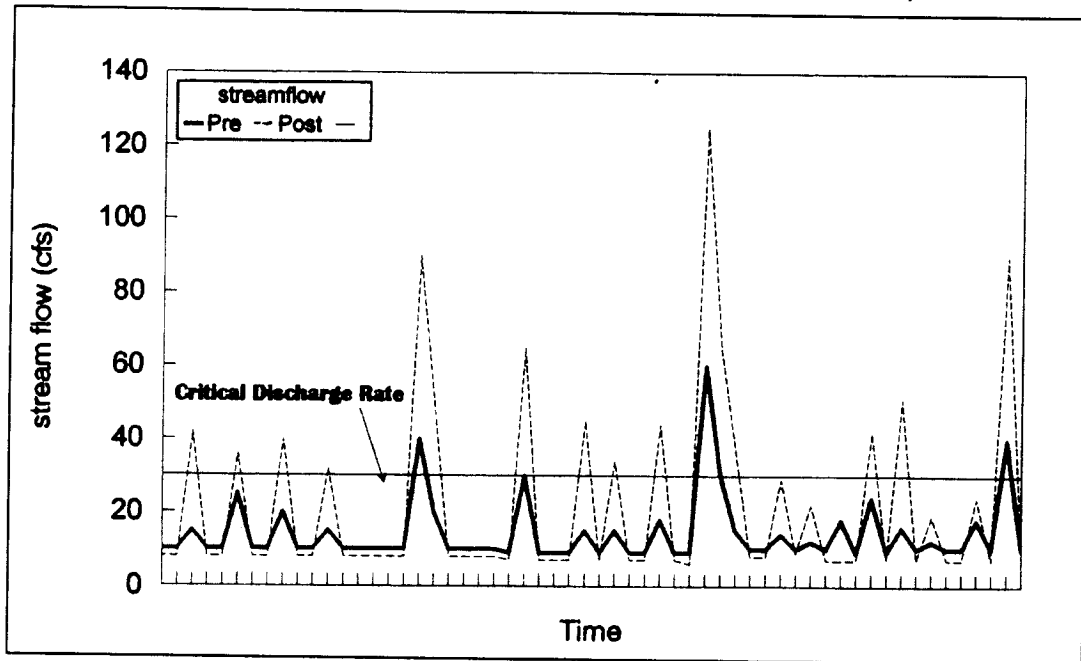

Channel enlargement in response to watershed development has been observed for decades, with research indicating that the stream channel area expands to between two and five times its original size in response to upland development (Hammer, 1972; Morisawa and LaFlure, 1979; Allen and Narramore, 1985; Booth, 1990). One researcher developed a direct relationship between the level of impervious cover and the “ultimate” channel enlargement, the area a stream will eventually reach over time (MacRae, 1996; Figure 2.5).

Figure 2.5 Relationship Between Impervious Cover and Channel Enlargement

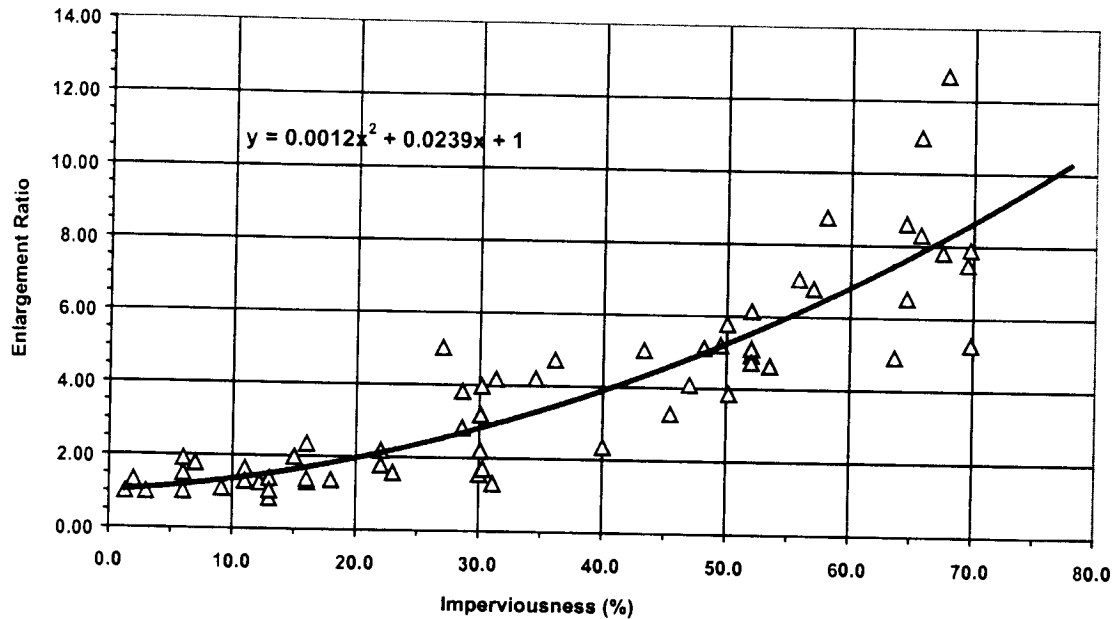

Historically, New York has used two-year control (i.e., reduction of the peak flow from the two-year storm to predeveloped levels) to prevent channel erosion, as required in the 1993 SPDES General Permit (GP-93-06). Research suggests that this measure does not adequately protect stream channels (McCuen and Moglen, 1988, MacRae, 1996). Although the peak flow is lower, it is also extended over a longer period of time, thus increasing the duration of erosive flows. In addition, the bankfull flow event actually becomes more frequent after development occurs. Consequently, capturing the two-year event may not address the channel-forming event.

This stream channel erosion and expansion, combined with direct impacts to the stream system, act to decrease the habitat quality of the stream. The stream will thus experience the following impacts to habitat (Table 2.3):

- Decline in stream substrate quality (through sediment deposition and embedding of the substrate)
- Loss of pool/riffle structure in the stream channel
- Degradation of stream habitat structure
- Creation of fish barriers by culverts and other stream crossings
- Loss of "large woody debris," which is critical to fish habitat

Table 2.3 Impacts to Stream Habitat			
Stream Channel Impact	Key Finding	Reference	Year
<i>Habitat Characteristics</i>			
Embeddedness	Interstitial spaces between substrate fill with increasing watershed imperviousness	Horner <i>et al.</i>	1996
Large Woody Debris (LWD)	Important for habitat diversity and anadromous fish.	Spence <i>et al.</i>	1996
	Decreased LWD with increases in imperviousness	Booth <i>et al.</i>	1996
Changes in Stream Features	Altered pool/riffle sequence with urbanization	Richey	1982
	Loss of habitat diversity	Scott <i>et al.</i>	1986
<i>Direct Channel Impacts</i>			
Reduction in 1 <sup>st</sup> Order Streams	Replaced by storm drains and pipes increases erosion rate downstream	Dunne and Leopold	1972
Channelization and hardening of stream channels	Increase instream velocities often leading to increased erosion rates downstream	Sauer <i>et al.</i>	1983
Fish Blockages	Fish blockages caused by bridges and culverts	MWCOG	1989

## Section 2.4 Increased Overbank Flooding

Flow events that exceed the capacity of the stream channel spill out into the adjacent floodplain. These are termed “overbank” floods, and can damage property and downstream structures. While some overbank flooding is inevitable and sometimes desirable, the historical goal of drainage design in New York has been to maintain pre-development peak discharge rates for both the two- and ten-year frequency storm after development, thus keeping the level of overbank flooding the same over time. This management technique prevents costly damage or maintenance for culverts, drainage structures, and swales.

Overbank floods are ranked in terms of their statistical return frequency. For example, a flood that has a 50% chance of occurring in any given year is termed a “two-year” flood. The two-year event is also known as the “bankfull flood,” as researchers have demonstrated that most natural stream channels in the State have just enough capacity to handle the two-year flood before spilling out into the floodplain. Although many factors, such as soil moisture, topography, and snowmelt, can influence the magnitude of a particular flood event, designers typically design for the “two-year” storm event. In New York State,

the two-year design storm ranges between about 2.0 to 4.0 inches of rain in a 24-hour period. Similarly, a flood that has a 10% chance of occurring in any given year is termed a "ten-year flood." A ten-year flood occurs when a storm event produces between 3.2 and 6.0 inches of rain in a 24-hour period. Under traditional engineering practice, most channels and storm drains in New York are designed with enough capacity to safely pass the peak discharge from the ten-year design storm.

Urban development increases the peak discharge rate associated with a given design storm, because impervious surfaces generate greater runoff volumes and drainage systems deliver it more rapidly to a stream. The change in post-development peak discharge rates that accompany development is profiled in Figure 2.6. Note that this change in hydrology increases not only the magnitude of the peak event, but the total volume of runoff produced.

Figure 2.6 Hydrographs Before and After Development

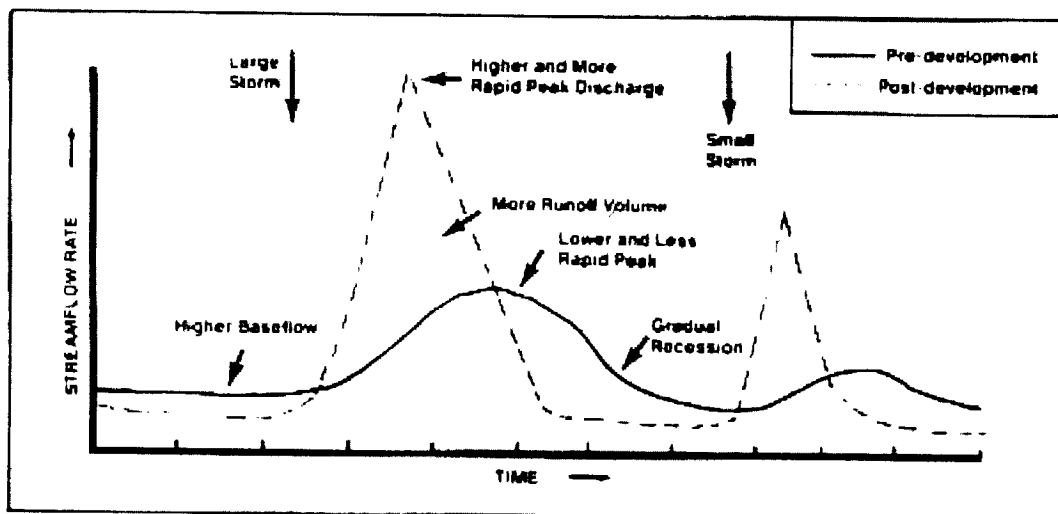



**Section 2.5 Floodplain Expansion**

The level areas bordering streams and rivers are known as floodplains. Operationally, the floodplain is usually defined as the land area within the limits of the 100-year storm flow water elevation. The 100-year storm has a 1% chance of occurring in any given year. In New York, a 100-year flood occurs after between five and eight inches of rainfall in a 24-hour period (i.e., the 100-year storm). These floods can be very destructive, and can pose a threat to property and human life.

As with overbank floods, development sharply increases the peak discharge rate associated with the 100-year design storm. As a consequence, the elevation of a stream's 100-year floodplain becomes higher and the boundaries of its floodplain expand (see Figure 2.7). In some instances, property and structures that had not previously been subject to flooding are now at risk. Additionally, such a shift in a floodplain's hydrology can degrade wetland and forest habitats.

**Figure 2.7 Floodplain Expansion with New Development**

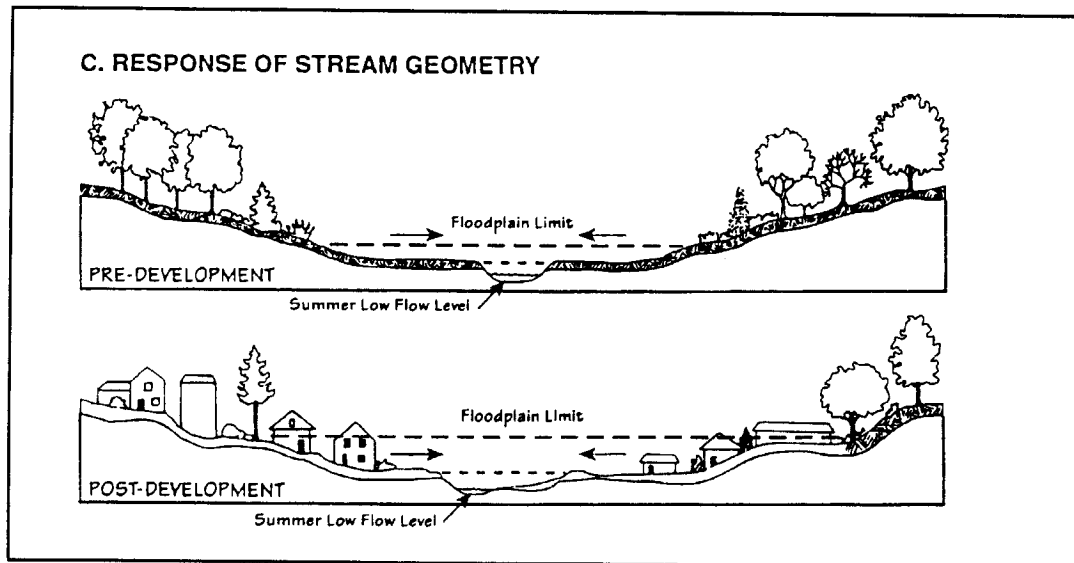

## Section 2.6 Impacts to Aquatic Organisms

The decline in the physical habitat of the stream, coupled with lower base flows and higher stormwater pollutant loads, has a severe impact on the aquatic community. Research suggests that new development impacts aquatic insects, fish, and amphibians at fairly low levels of imperviousness, usually around 10% impervious cover (Table 2.4). New development appears to cause declining **richness** (the number of different species in an area or community), **diversity** (number and relative frequency of different species in an area or community), and **abundance** (number of individuals in a species).

Watershed Indicator	Key Finding	Reference	Year	Location
Aquatic insects and fish	A comparison of three stream types found urban streams had lowest diversity and richness. Urban streams had substantially lower EPT scores (22% vs 5% as number of all taxa, 65% vs 10% as percent abundance) and IBI scores in the poor range.	Crawford & Lenat	1989	North Carolina
Insects, fish, habitat water quality,	Steepest decline of biological functioning after 6% imperviousness. There was a steady decline, with approx 50% of initial biotic integrity at 45% I.	Horner <i>et al.</i>	1996	Puget Sound Washington
Fish, Aquatic insects	A study of five urban streams found that as land use shifted from rural to urban, fish and macroinvertebrate diversity decreased.	Masterson & Bannerman	1994	Wisconsin
Insects, fish, habitat, water quality, riparian zone	Physical and biological stream indicators declined most rapidly during the initial phase of the urbanization process as the percentage of total impervious area exceeded the 5-10% range.	May <i>et al.</i>	1997	Washington
Aquatic insects and fish	There was significant decline in the diversity of aquatic insects and fish at 10% impervious cover.	MWCOG	1992	Washington, DC
Aquatic insects and fish	Evaluation of the effects of runoff in urban and non-urban areas found that native fish and insect species dominated the non-urban portion of the watershed, but native fish accounted for only 7% of the number of species found in urban areas.	Pitt	1995	California
Wetland plants, amphibians	Mean annual water fluctuation inversely correlated to plant & amphibian density in urban wetlands. Declines noted beyond 10% impervious area.	Taylor	1993	Seattle

Table 2.4 Recent Research Examining the Relationship of Urbanization to Aquatic Habitat and Organisms				
Watershed Indicator	Key Finding	Reference	Year	Location
Aquatic insects & fish	Residential urban land use in Cuyahoga watersheds created a significant drop in IBI scores at around 8%, primarily due to certain stressors that functioned to lower the non-attainment threshold. When watersheds smaller than 100mi <sup>2</sup> were analyzed separately, the level of urban land use for a significant drop in IBI scores occurred at around 15%.	Yoder <i>et. al.</i>	1999	Ohio
Aquatic insects & fish	All 40 urban sites sampled had fair to very poor index of biotic integrity (IBI) scores, compared to undeveloped reference sites.	Yoder	1991	Ohio
IBI: Index of Biotic Integrity: A measure of species diversity for fish and macroinvertebrates EPT: A measure of the richness of three sensitive macro-invertebrates (may flies, caddis flies, and stone flies), used to indicate the ability of a waterbody to support sensitive organisms.				

# Chapter 3

## Stormwater Permit Requirements

New York State Stormwater Management Design Manual

R0080233

## Chapter 3: Department of Environmental Conservation Permits

This chapter provides a summary of the applications that may need to be filed with the Department of Environmental Conservation (DEC) for new development projects. This section identifies general policies and timelines for filing a State Pollutant Discharge Elimination System ("SPDES") General Permit for stormwater discharges from construction activities as well as environmental permits under the Uniform Procedures Act (UPA). More detailed information on the permits and up-to-date regional contact information are available from the DEC web site at the following URLs:

[www.dec.state.ny.us/website/dcs/permits\\_level2.html](http://www.dec.state.ny.us/website/dcs/permits_level2.html)  
[www.dec.state.ny.us/website/dcs/upa/upa\\_permits.html](http://www.dec.state.ny.us/website/dcs/upa/upa_permits.html)

### Section 3.1 Filing for a Stormwater Permit

40 CFR Part 122 prohibits point source discharges of stormwater to waters of the United States without a permit issued under the National Pollutant Discharge Elimination System ("NPDES"). New York State is approved by the EPA to administer its SPDES program in lieu of EPA's NPDES program. The operator of a storm water discharge, which qualifies for coverage under the SPDES General Permit for stormwater, must submit a Notice of Intent (NOI) form to obtain permit coverage. Consult the general permit for any possible restrictions on eligibility of coverage. The permit includes a complete set of instructions for filing an NOI and for filing a Notice of Termination (NOT).

#### 3.1.1 *Where to File the NOI Form*

Completed NOIs should be sent to:

NYS DEC – Notice of Intent  
Bureau of Water Permits  
625 Broadway  
Albany, NY 12233-3505

#### 3.1.2 *Stormwater Pollution Prevention Plan*

The applicant must check whether the project will be a small or large one and whether the plan conforms to either NYSDEC or local Municipal Separate Storm Sewer System (MS4) requirements. The flow chart in Figure 3.1 identifies what components of the Stormwater Pollution Prevention Plan need to be prepared depending on the size and complexity of the site.

If one wishes to seek some variance from either local or NYSDEC requirements, then the information in Section V of the NOI must be filled out. The purpose of this section is to give NYSDEC some preliminary information. Based on the information provided, DEC will determine if other information is required. Only operators who state that their plan will NOT conform to either NYSDEC or local MS4 requirements need to fill out this section.

**Figure 3.1 Stormwater Pollution Prevention Plan Component Requirements**

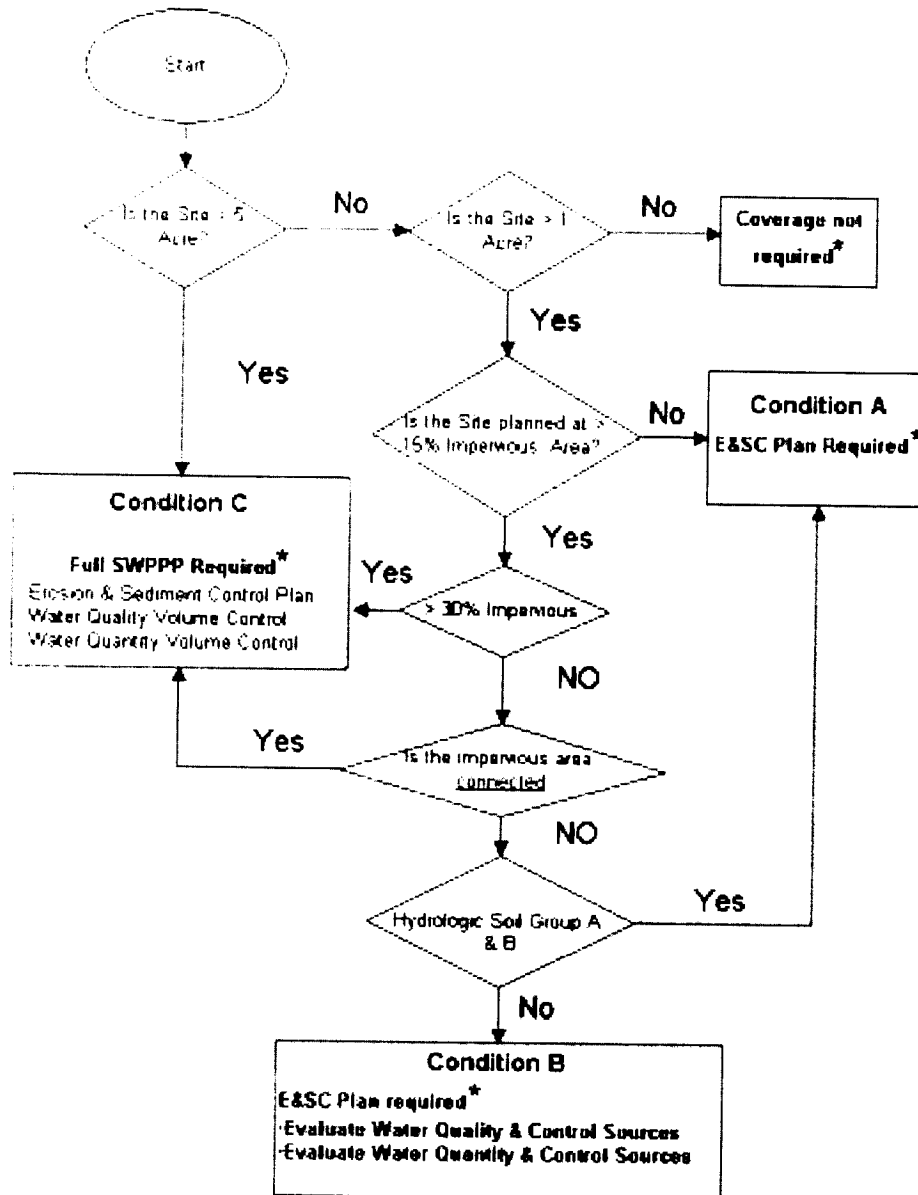

\* Under any of the above conditions other permits may be required

### 3.1.3 Review and Approval

Once the Notice of Intent (NOI) has been reviewed by DEC, an acknowledgement letter will be returned to the sender. Filing of an NOI does not supercede or negate the necessity to comply with other local laws and other state or federal requirements, which affect stormwater management. It is the responsibility of the operator to comply with any and all such regulations. Operators are encouraged to have their Stormwater Pollution Prevention Plan reviewed by the local Soil and Water Conservation District.

New York City has enacted various land use controls that affect certain construction projects in areas tributary to their drinking water reservoirs. Similarly, the Lake George Park Commission and the Adirondack Park Agency (APA) have enacted regulations which impact construction activity. The APA has jurisdiction over private lands within the Adirondack Park and requires environmental review for most land development projects. It also administers the State's Wild and Scenic Rivers and Freshwater Wetlands programs on these lands. Development within the APA's jurisdiction is not subject to SEQR. For more information, please contact the APA at 518-891-4050.

Other municipalities and agencies of New York State may have adopted similar legislation. It is the responsibility of the operator to comply with any and all such regulations. Table 3.1 provides a summary table describing the permits issued by DEC that may apply to the new development.

## **Section 3.2 Filing Other Permit Applications**

Most other environmental permits are administered under the UPA, which establishes uniform review procedures for the DEC's major regulatory programs and provides time periods for DEC action on applications for environmental protection permits. Generally permits identified under the UPA need to be filed through the DEC Regional Office. (See Figure 3.2 for regional contact information). If more than one permit is required, the applicant should submit all applications at one time. In addition, the applicant must list permits of other agencies that he or she knows to be applicable, together with a statement of the status of approval of the review under the State Environmental Quality Review (SEQR).

### 3.2.1 What Other Permits Do I Need to File?

Several permits under the UPA may be applicable to a particular development project. Table 3.1 lists many of permits required under the UPA that may apply to new residential, commercial, and industrial development in New York State, and provides a brief description of each. Please note that the table includes only the permits that are directly applicable to the stormwater and site plan development. Thus



several UPA permits may be required that are not included on this table, including Long Island Wells, Water Supply, 401 Water Quality Certification, Air Pollution Control, Mined Land Reclamation, Hazardous Waste Management Facilities, and Waste Transporter.

Table 3.1 Summary of Environmental Permits Issued by DEC That May Apply to New Development

3.1 Permit Title	3.2 Implementation Authority	3.2.1 Applicability	3.2.2 Regulated Activities
<u>State Pollutant Discharge Elimination System</u>	ECL Article 17 Division of Water	<ul style="list-style-type: none"> <li>Construction sites disturbing one acre or more.</li> </ul>	<p><i>Regulated:</i> Stormwater discharge associated with industrial activity, including new construction; point source discharges and disposal systems</p> <p><i>Exempted:</i> Agricultural discharge<sup>1</sup>, discharge of sewage effluent to groundwater less than 1,000 gallons a day.</p>
<u>Dam Safety</u>	ECL Article 15-0503 see <i>Guidelines for Design of Dams</i>	<ul style="list-style-type: none"> <li>Applies to on-stream and off-stream structures having height &gt; 6' and storage capacity &gt; 3MG, or height ≥ 15' and storage capacity ≥ 1 MG.</li> </ul>	<p><i>Regulated:</i> Construction, reconstruction, repair or removal of dams or impoundment.</p> <p><i>Exempted:</i> Structures for treatment or storage of wastewater, or materials other than water.</p>
<u>Freshwater Wetlands</u>	ECL Article 24 Division of Fish, Wildlife and Marine Resources	<ul style="list-style-type: none"> <li>Freshwater wetlands appearing on New York State freshwater wetland maps</li> <li>Generally limited to 12.4 acres or greater, but stricter requirements in the Adirondack Park</li> </ul>	<p><i>Regulated:</i> Construction of buildings, roadways, septic systems, dams, docks; filling, draining, or excavating; vegetation removal</p> <p><i>Exempted:</i> Ordinary maintenance and repair of existing structures; recreational activities</p>
<u>Tidal Wetlands</u>	ECL Article 25 NY DEC, Tidal Wetlands Regulatory Program	<ul style="list-style-type: none"> <li>Official DEC tidal wetlands maps.</li> <li>Anywhere tidal inundation occurs on a daily, monthly, or intermittent basis, including but not exclusively within the salt wedge (salt marshes, vegetated flats, and shorelines)<sup>2</sup></li> <li>Adjacent areas extend up to 300 ft. inland from wetland boundary (NYC 150 ft)</li> </ul>	<p><i>Regulated:</i> Residences and condos; accessory structures; commercial and industrial buildings; roadways and parking lots; boat ramps; septic systems; drainage structures; erosion control structures (groins, sea walls); docks, piers, etc.</p> <p>Clearing/clear cutting; beach nourishment; dredging, excavation, and grading.</p>
<u>Protection of Waters</u>	Title 5, ECL Article 15 Division of Fish, Wildlife and Marine Resources	Bed or banks of protected streams	<p><i>Regulated:</i> Modification or disturbance of the bed or banks of protected streams, including removal of sand or gravel; filling dredging in navigable waters; construction/modification/ repair of</p>

<sup>1</sup>- Eligible for coverage under Concentrated Animal Feeding Operation (CAFO)

<sup>2</sup> Applicable to Rockland and Westchester Counties, NYC and Long Island.

Table 3.1 Summary of Environmental Permits Issued by DEC That May Apply to New Development

Table 3.1 Summary of Environmental Permits Issued by DEC That May Apply to New Development			
			certain dams, docks, and mooring areas. <i>Exempted:</i> Ordinary maintenance
<u>Coastal Erosion Hazard Areas</u>	ECL Article 34 Division of Water	<ul style="list-style-type: none"> <li>Lands adjacent to Lakes Erie and Ontario; the St. Lawrence, Niagara, Harlem, East, and Hudson Rivers; Kill van Kull; Arthur Kill; Atlantic Ocean; and connective water-bodies.</li> <li>Natural Protective Features (NPF) nearshore areas; and landward Structural Hazard Areas (SHA)</li> </ul>	<i>Regulated:</i> Construction/ modification/ restoration of structures, e.g. buildings, docks, piers, walkways; Filling, draining or excavating; Construction/modification/restoration of erosion control structures <i>Exempted:</i> Ordinary maintenance and repair of existing structures
<u>Wild, Scenic, &amp; Recreational Rivers</u>	Title 27, ECL Article 15 Division of Fish, Wildlife and Marine Resources	All or portions of DEC-designated waterways: Three levels of classification include recreational rivers, scenic rivers, wild rivers	<i>Regulated:</i> Specifics depend on classification, but includes construction of residential, non-residential, accessory structures, and roads; Water quality, wastewater treatment, disposal; Vegetative cutting and agriculture; Recreational uses and development; Commercial and industrial uses.  <i>Exempted:</i> Continuation of existing land uses; Maintenance and repair--without changes
* UPA permits not included in this table are Long Island Wells, Water Supply, 401 Water Quality Certification, Air Pollution Control; Mined Land Reclamation, Hazardous Waste Management Facilities, Waste Transporter Source URL: ( <a href="http://www.dec.state.ny.us/website/dcs/upa/upa_permits.html">http://www.dec.state.ny.us/website/dcs/upa/upa_permits.html</a> )			

R0080240

### 3.2.2 *Schedule for DEC Review*

The time for permit approval depends on whether a project is determined to be UPA major or UPA minor. Each of the permits included in the UPA process has specific definitions of what constitutes UPA major and UPA minor projects. DEC first determines if an application is complete, and then begins the review process. For most projects, DEC must determine completeness within 15 days and for federally delegated permits within 60 days. For UPA minor projects, DEC must make a decision on the permit within 45 days of determining the application complete.

For UPA major projects, the length of time for review depends on whether a public hearing is required. If no hearing is required, DEC must make a decision within 90 days of determining the project complete. If a hearing is required, DEC notifies the applicant and the public of a hearing within 60 days of the completeness determination. The hearing must commence within 90 days of the completeness determination. Once the hearing ends, DEC must issue a final decision on the application within 60 days after receiving the final hearing record.

- **Dam Safety**

Constructing, reconstructing, repairing, or modifying dams and water impounding structures that permanently or temporarily impound water as a result of a structure placed across a watercourse or overland drainage way or which receive water from an external source such as drainage diversion or pumping of groundwater require a dam safety permit. Some examples of activities requiring this permit are: siting and constructing a new dam or water impounding structure, reconstruction, modification or maintenance which may affect the structural integrity or functional capability of a dam or impounding structure.

- **Freshwater Wetlands/Tidal Wetlands**

A freshwater or tidal wetlands permit may be required for work in or adjacent to wetlands designated by the State. Official tidal wetlands maps showing the locations of New York's regulated tidal wetlands are on file at DEC regional offices in Regions 1, 2, and 3, and in the County Clerks' Offices of Nassau, Suffolk, Bronx, Kings, New York, Queens, Richmond, Rockland, and Westchester Counties. They are also available at local assessing agencies in these areas. Official freshwater wetlands maps showing the locations of New York's wetlands are on file at DEC regional offices, the Adirondack Park Agency, and local government offices.

Wetlands permit applications require analysis of alternatives. Even when a development is adjacent to a regulated wetland, the site plan and stormwater management plan need to be modified to adequately protect these resources.

- **Protection of Waters**

This permit applies to the dredging and filling in navigable waters and dams and work on the banks of protected streams. The permit also regulates the construction of dams in both waterways and overland drainage ways. When a site plan includes dam construction as a part of a quantity or quality control requirement, a permit will be required unless the following conditions are met:

- Maximum height is six feet or less (maximum height is measured as the height from the downstream (outside) toe of the dam at its lowest point to the highest point at the top of the dam).
- Maximum impounding capacity is one million gallons or less (maximum impounding capacity is measured as the volume of water impounded when the water level is at the top of the dam).
- Maximum height is between six feet and 15 feet and the maximum impounding capacity is less than three million gallons.

- **Coastal Erosion Hazard Areas**

This permit is required where coastal erosion is a concern, and applies to Natural Protective Features (NPFs), such as sand dunes, and a Shoreline Hazard Area (SHA) defined based on the annual recession rate of the coast. The permit is required for construction of any structures within the SHA, and the permittee must demonstrate that the proposed project does not contribute to coastal erosion.

- **Wild, Scenic, & Recreational Rivers**

This regulation applies strict regulations, which restrict certain uses for development bordering wild, scenic, or recreational rivers in New York State. Furthermore, the applicant must demonstrate that no reasonable alternative exists, and that the proposed activity will not have an undue adverse environmental impact. Listed waterways include:

Scenic Rivers

Carmans River

Peconic River

East Canada Creek

Grasse River

Oswegatchie River

GenesseeRiver

Recreational Rivers

Carmans River

Ramapo River

Connetquot River

Shawangunk Kill

Nissequogue River

Ausable River

Peconic River

Fall Creek

- **State Environmental Quality Review Act (SEQR)**

Many projects are subject to SEQR. It is important that operators inform local governments about their projects and obtain necessary local approvals before starting work. Projects, for which only a general permit is needed, are not subject to SEQR. If any other permits are required, the applicant must submit applications, which are reviewed in accordance with SEQR.

All agencies involved (state and local), must consider the environmental impacts of construction projects before approving, funding, or directly undertaking an action. Development projects subject to SEQR will require an Environmental Assessment Form. If a project may have a significant environmental impact, an Environmental Impact Statement (EIS) will be required. Projects will require public involvement as a part of this process.

Figure 3.2 New York State Regional Contact Information

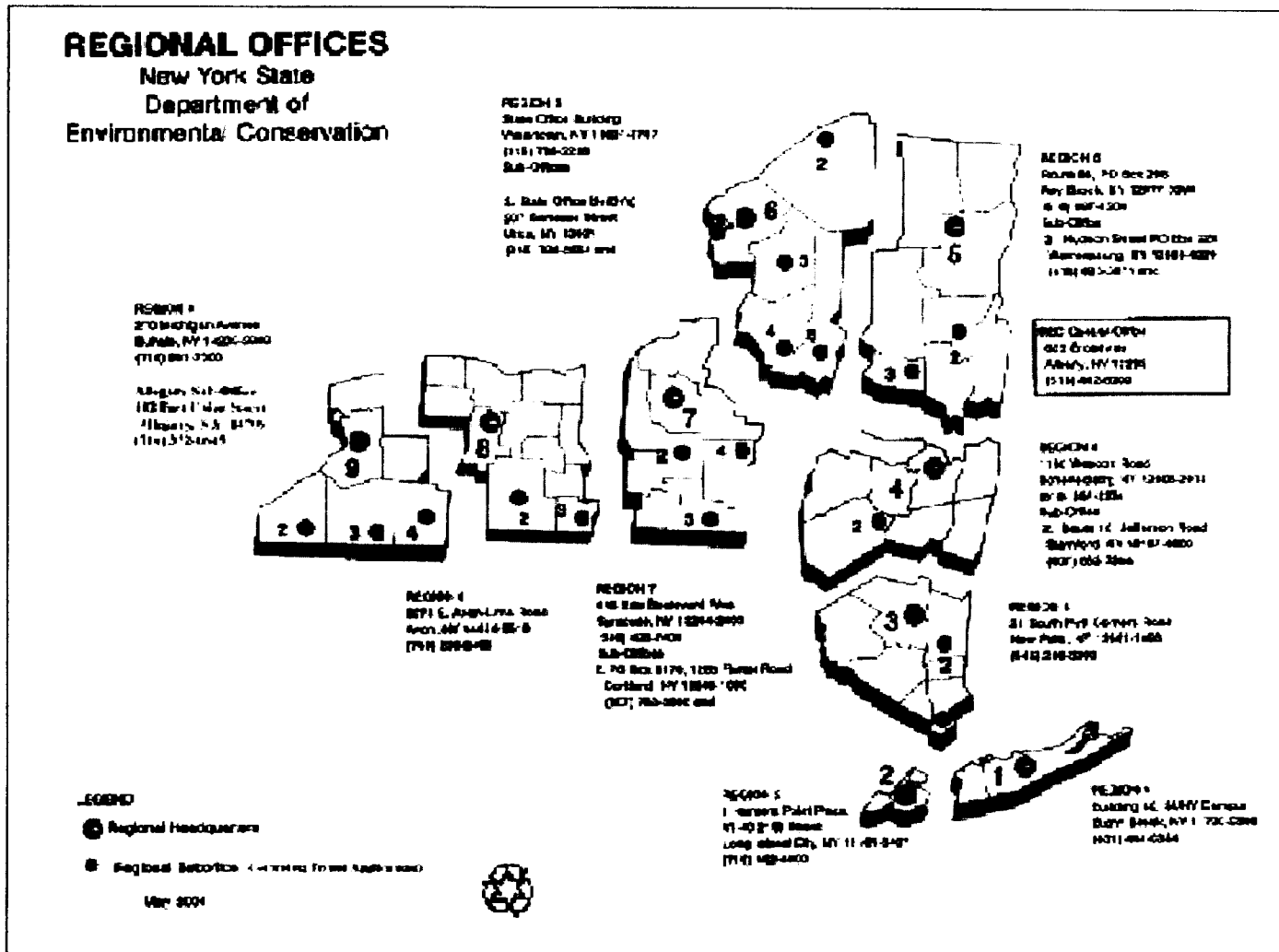

R0080244

# Chapter 4

## Unified Stormwater Sizing Criteria



## Chapter 4: Unified Stormwater Sizing Criteria

### Section 4.1 Introduction

This chapter presents a unified approach for sizing SMPs in the State of New York to meet pollutant removal goals, reduce channel erosion, prevent overbank flooding, and help control extreme floods. For a summary, please consult Table 4.1 below. The remaining sections describe the four sizing criteria in detail and present guidance on how to properly compute and apply the required storage volumes.

Table 4.1 New York Stormwater Sizing Criteria	
<b>Water Quality (WQ<sub>v</sub>)</b>	<p><b>90% Rule:</b></p> $WQ_v = [(P)(R_v)(A)] / 12$ $R_v = 0.05 + 0.009(I)$ <p>I = Impervious Cover (Percent)            Minimum R<sub>v</sub> = 0.2            P = 90% Rainfall Event Number (See Figure 4.1)            A = site area in acres</p>
<b>Channel Protection (Cp<sub>v</sub>)</b>	<p><b>Default Criterion:</b>            Cp<sub>v</sub> = 24 hour extended detention of post-developed 1-year, 24-hour storm event.</p> <p><b>Option for Sites Larger than 50 Acres:</b>            Distributed Runoff Control - geomorphic assessment to determine the bankfull channel characteristics and thresholds for channel stability and bedload movement.</p>
<b>Overbank Flood (Q<sub>p</sub>)</b>	Control the peak discharge from the 10-year storm to 10-year predevelopment rates.
<b>Extreme Storm (Q<sub>t</sub>)</b>	Control the peak discharge from the 100-year storm to 100-year predevelopment rates. Safely pass the 100-year storm event.
<p><i>Note: The local review authority may waive channel protection, overbank flood, and extreme storm requirements in some instances. Guidance is provided in this chapter.</i></p>	

### Section 4.2 Water Quality Volume (WQ<sub>v</sub>)

The Water Quality Volume (denoted as the WQ<sub>v</sub>) is designed to improve water quality sizing to capture and treat 90% of the average annual stormwater runoff volume. The WQ<sub>v</sub> is directly related to the amount of impervious cover created at a site. Contour lines of the 90% rainfall event are presented in Figure 4.1.

The following equation can be used to determine the water quality storage volume WQ<sub>v</sub> (in acre-feet of storage):

$$WQ_v = \frac{(P)(R_v)(A)}{12}$$

where:

- WQ<sub>v</sub> = water quality volume (in acre-feet)
- P = 90% Rainfall Event Number (see Figure 4.1)
- R<sub>v</sub> = 0.05 + 0.009(I), where I is percent impervious cover
- A = site area in acres

A minimum WQ<sub>v</sub> of 0.2 inches per acre shall be met at residential sites that have less than 17% impervious cover.

Figure 4.1 90% Rainfall in New York State

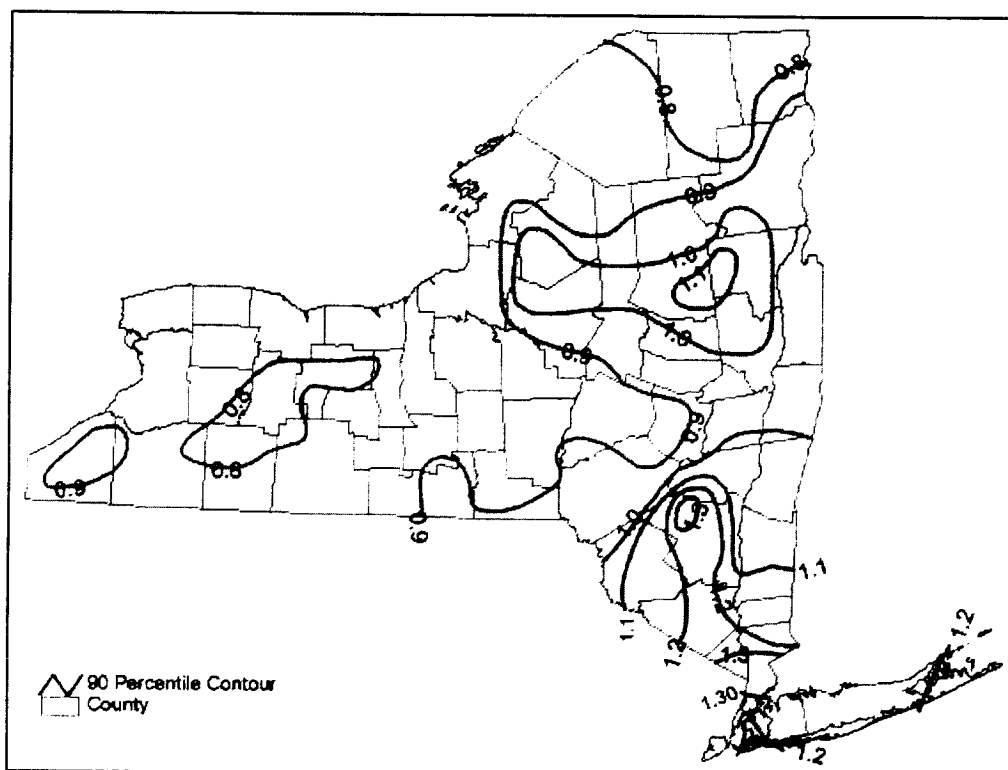

It is assumed that by meeting the WQ<sub>v</sub> requirements through employment of the practices presented in Table 5.1 a project will, by default, meet water quality objectives. In some jurisdictions, on-site load calculations are required to demonstrate removal of specific pollutants. As an aid to communities, Appendix A of this manual includes a discussion of a method for calculating pollutant export loads from development sites. This method, known as the "Simple Method," provides estimates for stormwater runoff pollutant loads for urban areas using a modest amount of information, including the subwatershed drainage area and impervious cover, stormwater runoff pollutant concentrations, and annual precipitation. Please consult Appendix A for a more detailed discussion of the Simple Method and its applications for water quality determinations. Please note that the Simple Method is intended as an analysis tool, and should not be used to guide the design of SMPs.

#### *Basis Of Design for Water Quality*

As a basis for design, the following assumptions may be made:

- *Measuring Impervious Cover:* the measured area of a site plan that does not have permanent vegetative or permeable cover shall be considered total impervious cover. Impervious cover is defined as all impermeable surfaces and includes: paved and gravel road surfaces, paved and gravel parking lots, paved driveways, building structures, paved sidewalks, and miscellaneous impermeable structures such as patios, pools, and sheds. Porous or modular block pavement may be considered 50% impervious. Where site size makes direct measurement of impervious cover impractical, the land use/impervious cover relationships presented in Table 4.2 can be used to initially estimate impervious cover.

<b>Table 4.2 Land Use and Impervious Cover (Source: Cappiella and Brown, 2001)</b>	
<b>Land Use Category</b>	<b>Mean Impervious Cover</b>
Agriculture	<b>2</b>
Open Urban Land*	<b>9</b>
2 Acre Lot Residential	<b>11</b>
1 Acre Lot Residential	<b>14</b>
1/2 Acre Lot Residential	<b>21</b>

Table 4.2 Land Use and Impervious Cover (Source: Capiella and Brown, 2001)	
Land Use Category	Mean Impervious Cover
1/4Acre Lot Residential	28
1/8 Acre Lot Residential	33
Townhome Residential	41
Multifamily Residential	44
Institutional**	28-41%
Light Industrial	48-59%
Commercial	68-76%
* Open urban land includes developed park land, recreation areas, golf courses, and cemeteries. ** Institutional is defined as places of worship, schools, hospitals, government offices, and police and fire stations	

- *Aquatic Resources:* More stringent local regulations may be in place or may be required to protect drinking water reservoirs, lakes, or other sensitive aquatic resources. Consult the local authority to determine the full requirements for these resources.
  
- *SMP Treatment:* The final  $WQ_v$  shall be treated by an acceptable practice from the list presented in this manual. Please consult Chapter 5 for a list of acceptable practices.
  
- *Determining Peak Discharge for  $WQ_v$  Storm:* When designing flow splitters for off-line practices, consult the small storm hydrology method provided in Appendix B.
  
- *Extended Detention for Water Quality Volume:* The water quality requirement can be met by providing 24 hours of the  $WQ_v$  (provided a micropool is specified) extended detention. A local jurisdiction may reduce this requirement to as little as 12 hours in trout waters to prevent stream warming.
  
- *Off-site Areas:* Provide treatment for off-site areas in their current condition. If water quality treatment is provided off-line, the practice must only treat on-site runoff.

**Section 4.3 Stream Channel Protection Volume Requirements ( $C_{pv}$ )**

Stream Channel Protection Volume Requirements ( $C_{pv}$ ) are designed to protect stream channels from erosion. In New York State this goal is accomplished by providing 24-hour extended detention of the one-year, 24-hour storm event. Trout waters may be exempted from the 24-hour ED requirement, with only 12 hours of extended detention required to meet this criterion.

For developments greater than 50 acres, with impervious cover greater than 25%, it is recommended that a detailed geomorphic assessment be performed to determine the appropriate level of control. Appendix J provides guidance on how to conduct this assessment.

The  $C_{pv}$  requirement does not apply in certain conditions, including the following:

- Recharge of the entire  $C_{pv}$  volume is achieved at a site.
- The site discharges directly tidal waters or fourth order (fourth downstream) or larger streams. Within New York State, streams are classified using the following:  
New York State Codes Rules and Regulations (NYCRR)  
Volumes B-F, Parts 800-941  
West Publishing, Eagan, MN
- A downstream analysis reveals that channel protection is not required (see section 4.7).

Detention ponds or underground vaults are methods to meet the  $C_{pv}$  requirement (and subsequent  $Q_{p10}$  and  $Q_f$  criteria). Schematics of typical designs are shown in Figures 4.2. and 4.3. Note that, although these practices meet water quantity goals, they are unacceptable for water quality because of poor pollutant removal, and need to be coupled with a practice listed in Table 5.1. The  $C_{pv}$  requirement may also be provided above the water quality ( $WQ_v$ ) storage in a wet pond or stormwater wetland.

*Basis for Determining Channel Protection Storage Volume*

The following represent the minimum basis for design:

- TR-55 and TR-20 (or approved equivalent) shall be used to determine peak discharge rates.
- Rainfall depths for the one-year, 24 hour storm event are provided in Figure 4.4.
- Off-site areas should be modeled as "present condition" for the one-year, 24 hour storm event.
- The length of overland flow used in time of concentration ( $t_c$ ) calculations is limited to no more than 100 feet for post development conditions.
- $C_{pv}$  is not required at sites where the resulting diameter of the ED orifice is too small to prevent clogging. (A minimum 3" orifice with a trash rack or 1" if the orifice is protected by a standpipe

having slots with an area less than the internal orifice are recommended to prevent clogging. See Figure 3 in Appendix K for design details).

- Extended detention storage provided for the channel protection ( $C_{p,ED}$ ) does not meet the  $WQ_v$  requirement. Both water quality and channel protection storage may be provided in the same SMP, however.
- The  $CP_v$  detention time for the one-year storm is defined as the time difference between the center of mass of the inflow hydrograph (entering the SMP) and the center of mass of the outflow hydrograph (leaving the SMP). See Appendix B for a methodology for detaining this storm event.

Figure 4.2 Example of a Conventional Stormwater Detention Pond

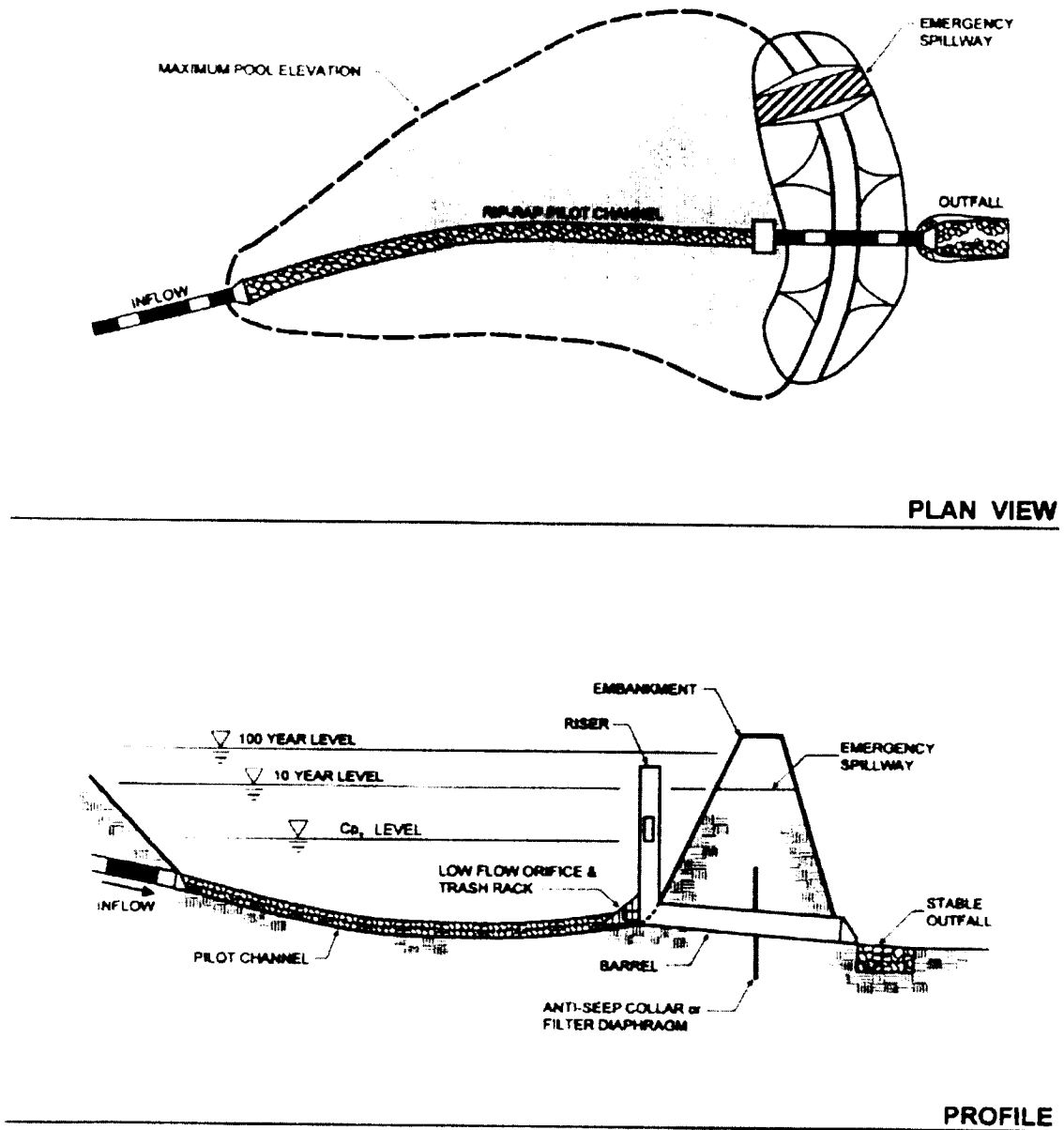

A typical detention facility provides channel protection control ( $C_{pv}$ ) and overbank control ( $Q_p$ ) but no water quality control ( $WQ_v$ ). If this practice is used,  $WQ_v$  must be provided in a separate facility listed in Table 5.1.

Figure 4.3 Example of Stormwater Detention Provided by an Underground Pipe System

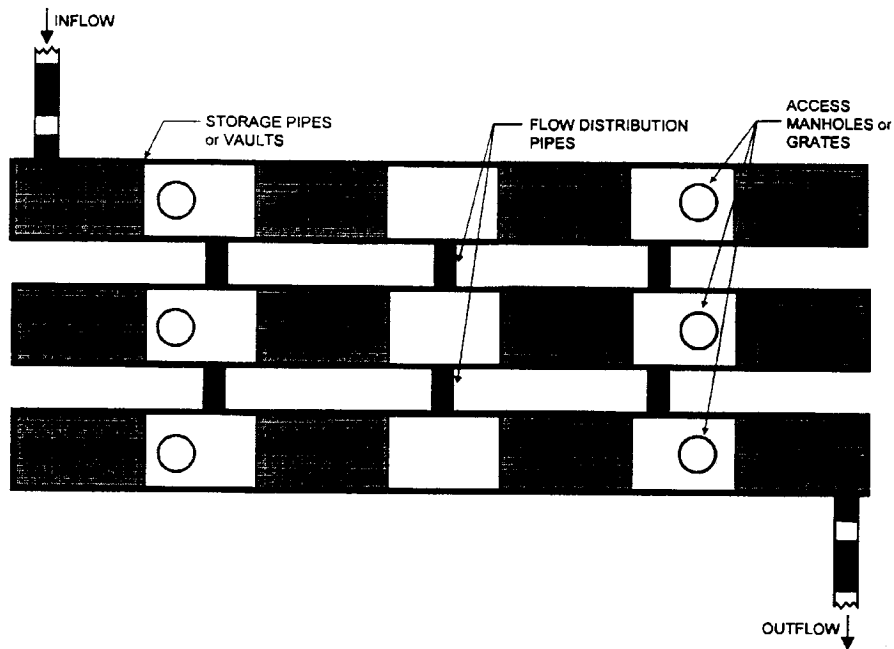

PLAN VIEW

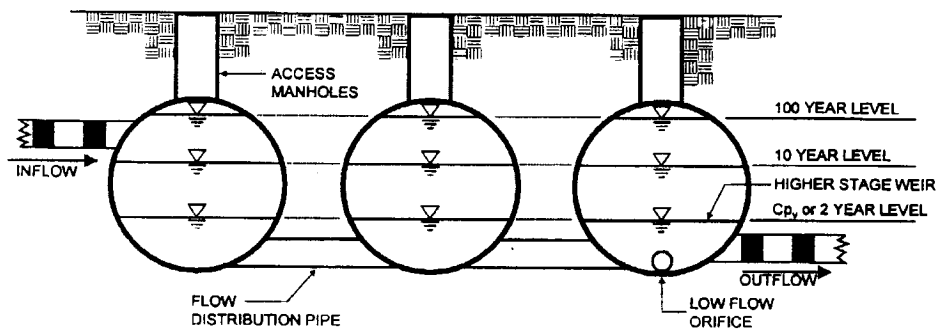

TYPICAL SECTION

An underground pipe system or vaults may be used to provide  $C_p$ ,  $Q_p$  and  $Q_f$  controls but not  $WQ_v$ .



Figure 4.4 One-Year Design Storm

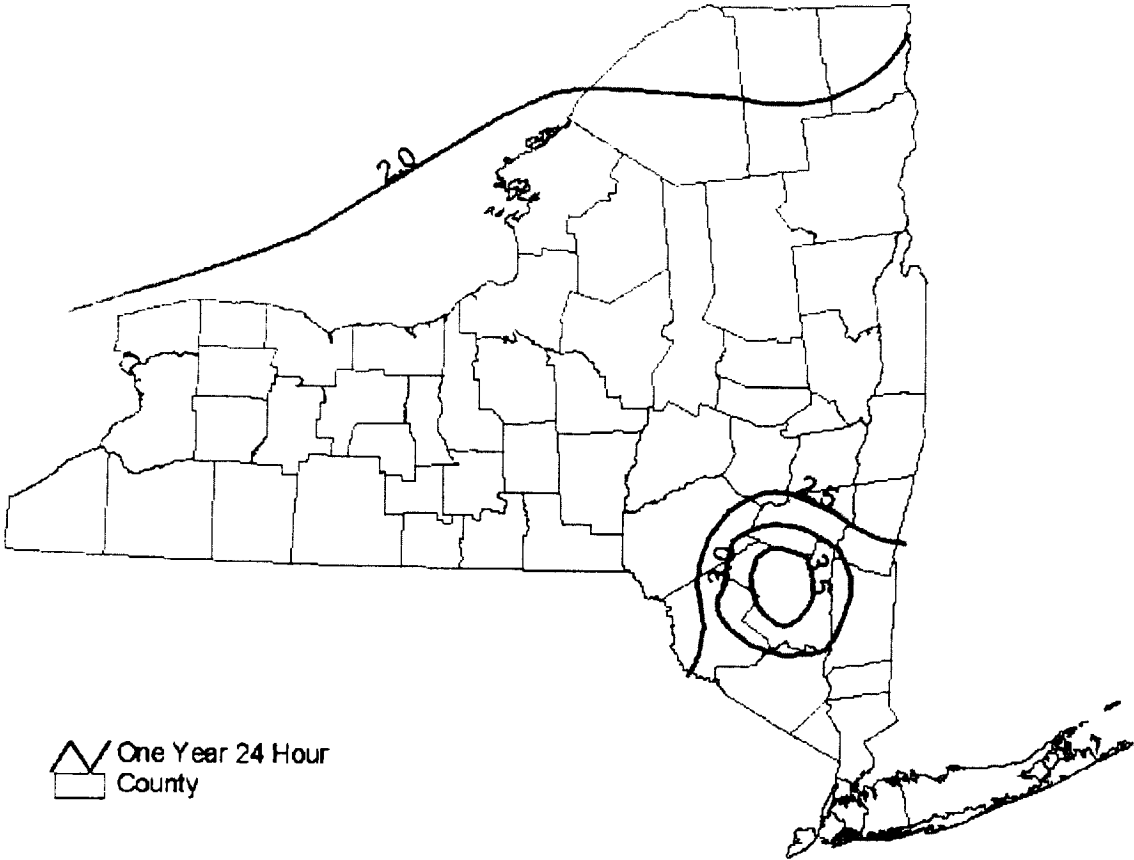

**Section 4.4 Overbank Flood Control Criteria ( $Q_p$ )**

The primary purpose of the overbank flood control sizing criterion is to prevent an increase in the frequency and magnitude of out-of-bank flooding generated by urban development (i.e., flow events that exceed the bankfull capacity of the channel, and therefore must spill over into the floodplain).

Overbank control requires storage to attenuate the post development 10-year, 24-hour peak discharge rate ( $Q_p$ ) to predevelopment rates.

The overbank flood control requirement ( $Q_p$ ) does not apply in certain conditions, including:

- The site discharges directly tidal waters or fourth order (fourth downstream) or larger streams. Within New York State, streams are classified using the following:  
New York State Codes Rules and Regulations (NYCRR)  
Volumes B-F, Parts 800-941  
West Publishing, Eagan, MN
- A downstream analysis reveals that overbank control is not needed (see section 4.7).

*Basis for Design of Overbank Flood Control*

When addressing the overbank flooding design criteria, the following represent the minimum basis for design:

- TR-55 and TR-20 (or approved equivalent) will be used to determine peak discharge rates.
- When the predevelopment land use is agriculture, the curve number for the pre-developed condition shall be derived from the recommended five-year crop rotation for a region, from the local Soil Conservation Service, or from the historical five-year crop rotation for the site, whichever results in a lower curve number value.
- Off-site areas should be modeled as "present condition" for the 10-year storm event.
- Figure 4.5 indicates the depth of rainfall (24 hour) associated with the 10-year storm event throughout the State of New York.
- The length of overland flow used in  $t_c$  calculations is limited to no more than 150 feet for predevelopment conditions and 100 feet for post development conditions. On areas of extremely flat terrain (<1% average slope), this maximum distance is extended to 250 feet for predevelopment conditions and 150 feet for postdevelopment conditions.

Figure 4.5 10-Year Design Storm

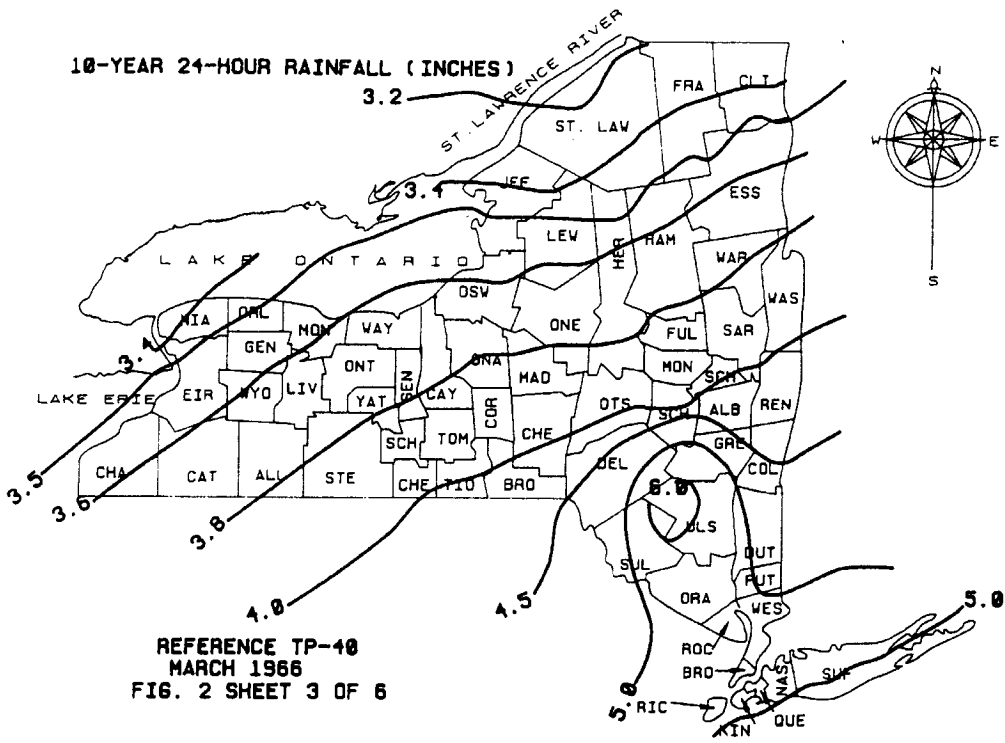

**Section 4.5 Extreme Flood Control Criteria ( $Q_f$ )**

The intent of the extreme flood criteria is to (a) prevent the increased risk of flood damage from large storm events, (b) maintain the boundaries of the predevelopment 100-year floodplain, and (c) protect the physical integrity of stormwater management practices

*100 Year Control* requires storage to attenuate the post development 100-year, 24-hour peak discharge rate ( $Q_f$ ) to predevelopment rates.

The 100-year storm control requirement can be waived if:

- The site discharges directly tidal waters or fourth order (fourth downstream) or larger streams. Within New York State, streams are classified using the following:  
New York State Codes Rules and Regulations (NYCRR)  
Volumes B-F, Parts 800-941  
West Publishing, Eagan, MN
- Development is prohibited within the ultimate 100-year floodplain
- A downstream analysis reveals that 100-year control is not needed (see section 4.7)

Detention structures must provide safe overflow of the 100-year flood, as discussed in the New York State Department of Environmental Conservation publication: "Guidelines for the Design of Dams," available from the Bureau of Flood Protection at 518-402-8151.

*Basis for Design for Extreme Flood Criteria*

- Consult with the appropriate review authority *including the local municipality's flood protection permit administrator*, to determine the analysis required for the  $Q_f$  storm.
- The same hydrologic and hydraulic methods used for overbank flood control shall be used to analyze  $Q_f$ .
- Figure 4.6 indicates the depth of rainfall (24 hour) associated with the 100-year storm event throughout New York State.
- When determining the storage required to reduce 100-year flood peaks, model off-site areas under current conditions.
- When determining storage required to safely pass the 100-year flood, model off-site areas under ultimate conditions.

Figure 4.6 100-Year Design Storm

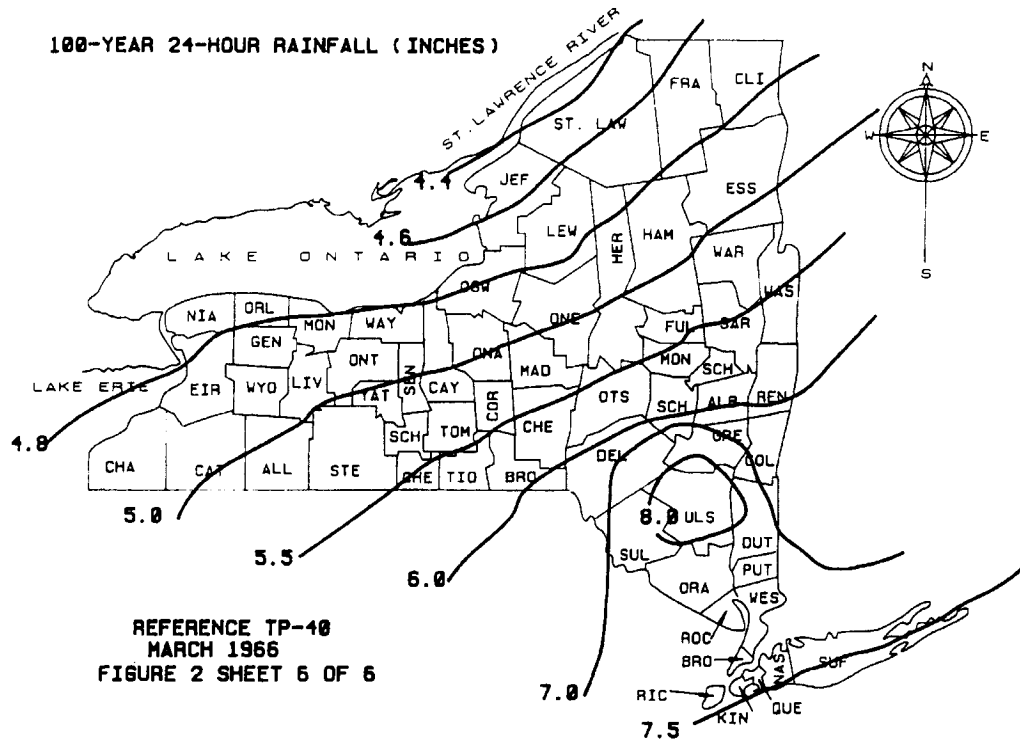

**Section 4.6 Conveyance Criteria**

In addition to the stormwater treatment volumes described above, the manual also provides guidance on safe and non-erosive conveyance to, from, and through SMPs. Typically, the targeted storm frequencies for conveyance are the two-year and ten-year events. The two-year event is used to ensure non-erosive flows through roadside swales, overflow channels, pond pilot channels, and over berms within practices. Figure 4.7 presents rainfall depths for the two-year, 24-hour storm event throughout New York State. The 10-year storm is typically used as a target sizing for outfalls, and as a safe conveyance criterion for open channel practices and overflow channels. Note that some agencies or municipalities may use a different design storm for this purpose.

**Section 4.7 Downstream Analysis**

A community may waive the channel protection, overbank, and extreme flood requirements based on the results of a downstream analysis. In addition, such an analysis is recommended for larger sites (i.e., greater than 50 acres) to size facilities in the context of a larger watershed. The analysis will help ensure that storage provided at a site is appropriate to when combined with upstream and downstream flows. For example, detention at a site may in some instances exacerbate flooding problems within a watershed. This section provides brief guidance for conducting this analysis, including the area of stream to be evaluated and minimum elements to be included in the analysis.

Downstream analysis can be conducted using the 10% rule. That is, the analysis should extend downstream to the point where the site represents 10% of the total drainage area. For example, the analysis point for a 10-acre site would be analyzed to the nearest downstream point with a drainage area of 100 acres.

The analysis should include the following:

- Computation of flows and velocities for channel protection, overbank, and flood control storms at 200-foot intervals, at the point where the 10% rule is met, and at all confluences along the downstream channel with first order or higher streams.
- Hydrologic and hydraulic effects of all culverts and/or obstructions within the downstream channel.
- An assessment of water surface elevations to determine if an increase in water surface elevations will impact existing buildings and other structures.

The design, or waiver, at a site level can be approved if the following criteria are met:

- Flow rates and velocities increase by less than 5% of the pre-developed condition for all flow conditions analyzed.
- No downstream structures or buildings are impacted.
- The site as designed is not expected to exacerbate downstream channel erosion.

Figure 4.7. Two-Year Design Storm

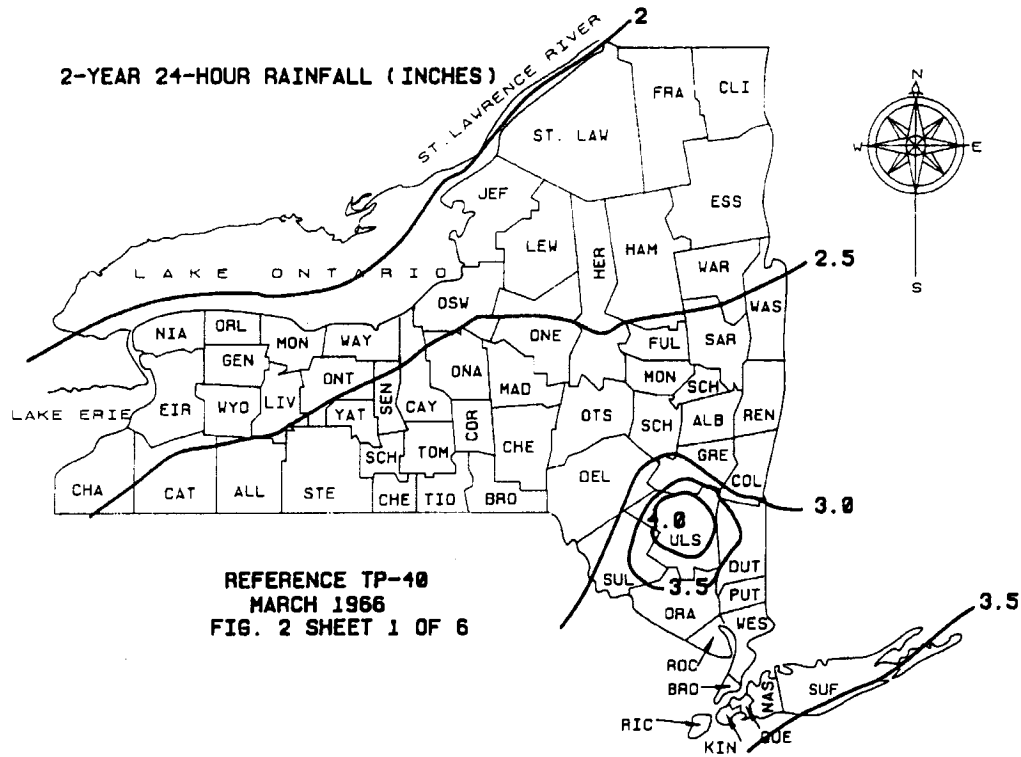

**Section 4.8 Stormwater Hotspots**

A stormwater hotspot is defined as a land use or activity that generates higher concentrations of hydrocarbons, trace metals or toxicants than are found in typical stormwater runoff, based on monitoring studies. If a site is designated as a hotspot, it has important implications for how stormwater is managed. First and foremost, stormwater runoff from hotspots cannot be allowed to infiltrate into groundwater, where it may contaminate water supplies. Second, a greater level of stormwater treatment is needed at hotspot sites to prevent pollutant washoff after construction. This treatment plan typically involves preparing and implementing a *stormwater pollution prevention plan* that involves a series of operational practices at the site that reduce the generation of pollutants from a site or prevent contact of rainfall with the pollutants. Table 4.3 provides a list of designated hotspots for the State of New York

Under EPA’s stormwater NPDES program, some industrial sites are required to prepare and implement a stormwater pollution prevention plan. A list of industrial categories that are subject to the pollution prevention requirement can be found in the State of New York SPDES. In addition, New York’s requirements for preparing and implementing a stormwater pollution prevention plan are described in the SPDES general discharge permit. The stormwater pollution prevention plan requirement applies to both existing and new industrial sites.

<b>Table 4.3 Classification of Stormwater Hotspots</b>
<p>The following land uses and activities are deemed <i>stormwater hotspots</i>:</p> <ul style="list-style-type: none"> <li>• Vehicle salvage yards and recycling facilities #</li> <li>• Vehicle fueling stations</li> <li>• Vehicle service and maintenance facilities</li> <li>• Vehicle and equipment cleaning facilities #</li> <li>• Fleet storage areas (bus, truck, etc.) #</li> <li>• Industrial sites (based on SIC codes outlined in the SPDES)</li> <li>• Marinas (service and maintenance) #</li> <li>• Outdoor liquid container storage</li> <li>• Outdoor loading/unloading facilities</li> <li>• Public works storage areas</li> <li>• Facilities that generate or store hazardous materials #</li> <li>• Commercial container nursery</li> <li>• Other land uses and activities as designated by an appropriate review authority</li> </ul>
<p># indicates that the land use or activity is required to prepare a <i>stormwater pollution prevention plan</i> under the SPDES stormwater program.</p>



The following land uses and activities are not normally considered hotspots:

- Residential streets and rural highways
- Residential development
- Institutional development
- Office developments
- Non-industrial rooftops
- Pervious areas, except golf courses and nurseries (which may need an Integrated Pest Management (IPM) Plan).

While large highways (average daily traffic volume (ADT) greater than 30,000) are not designated as a stormwater hotspot, it is important to ensure that highway stormwater management plans adequately protect groundwater.

# Chapter 5

## List of Acceptable Stormwater Management Practices

## Chapter 5: Acceptable Stormwater Management Practices (SMPs)

This section presents a list of practices that are acceptable for water quality treatment. The practices on this list are selected based on the following criteria:

1. Can capture and treat the full water quality volume (WQ<sub>v</sub>)
2. Are capable of 80% TSS removal and 40% TP removal.
3. Have acceptable longevity in the field.
4. Have a pretreatment mechanism.

It also provides data justifying the use of these practices, and minimum criteria for the addition of new practices to the list.

### Section 5.1 Practice List

Practices on the following list will be presumed to meet water quality requirements set forth in this manual if designed in accordance with the sizing criteria presented in Chapter 4 and constructed in accordance with the performance criteria in Chapter 6. The practices must also be maintained properly in accordance with the prescribed maintenance criteria also presented in Chapter 6. Acceptable practices are divided into five broad groups, including:

- I. **Stormwater Ponds** Practices that have either a permanent pool of water or a combination of permanent pool and extended detention capable of treating the WQ<sub>v</sub>.
- II. **Stormwater Wetlands** Practices that include significant shallow marsh areas, and may also incorporate small permanent pools and extended detention storage to achieve the full WQ<sub>v</sub>.
- III. **Infiltration Practices** Practices that capture and temporarily store the WQ<sub>v</sub> before allowing it to infiltrate into the soil.
- IV. **Filtering Practices** Practices that capture and temporarily store the WQ<sub>v</sub> and pass it through a filter bed of sand, organic matter, soil, or other acceptable treatment media.
- V. **Open Channel Practices** Practices explicitly designed to capture and treat the full WQ<sub>v</sub> within dry or wet cells formed by check dams or other means.

Within each of these broad categories, select practices are presumed to meet the established water quality goals (see Table 5.1). It is important to note that several practices that are not on the list may be of value as pretreatment, or to meet water quantity requirements (see Section 5.2). Guidance on the performance criteria for each practice type and matrices for selecting practices are provided in Chapters 6 and 7.

Table 5.1 Stormwater Management Practices Acceptable for Water Quality		
Group	Practice	Description
Pond	Micropool Extended Detention Pond (P-1)	Pond that treats the majority of the water quality volume through extended detention, and incorporates a micropool at the outlet of the pond to prevent sediment resuspension.
	Wet Pond (P-2)	Pond that provides storage for the entire water quality volume in the permanent pool.
	Wet Extended Detention Pond (P-3)	Pond that treats a portion of the water quality volume by detaining storm flows above a permanent pool for a specified minimum detention time.
	Multiple Pond System (P-4)	A group of ponds that collectively treat the water quality volume.
	Pocket Pond (P-5)	A stormwater wetland design adapted for the treatment of runoff from small drainage areas that has little or no baseflow available to maintain water elevations and relies on ground water to maintain a permanent pool.
Wetland	Shallow Wetland (W-1)	A wetland that provides water quality treatment entirely in a wet shallow marsh.
	Extended Detention Wetland (W-2)	A wetland system that provides some fraction of the water quality volume by detaining storm flows above the marsh surface.
	Pond/ Wetland System (W-3)	A wetland system that provides a portion of the water quality volume in the permanent pool of a wet pond that precedes the marsh for a specified minimum detention time.
	Pocket Wetland (W-4)	A shallow wetland design adapted for the treatment of runoff from small drainage areas that has variable water levels and relies on groundwater for its permanent pool.
Infiltration	Infiltration Trench (I-1)	An infiltration practice that stores the water quality volume in the void spaces of a gravel trench before it is infiltrated into the ground.
	Infiltration Basin (I-2)	An infiltration practice that stores the water quality volume in a shallow depression, before it is infiltrated it into the ground.
	Dry Well (I-3)	An infiltration practice similar in design to the infiltration trench, and best suited for treatment of rooftop runoff.
Filtering Practices	Surface Sand Filter (F-1)	A filtering practice that treats stormwater by settling out larger particles in a sediment chamber, and then filtering stormwater through a sand matrix.
	Underground Sand Filter (F-2)	A filtering practice that treats stormwater as it flows through underground settling and filtering chambers.
	Perimeter Sand Filter (F-3)	A filter that incorporates a sediment chamber and filter bed as parallel vaults adjacent to a parking lot.
	Organic Filter (F-4)	A filtering practice that uses an organic medium such as compost in the filter, in the place of sand.
	Bioretention (F-5)	A shallow depression that treats stormwater as it flows through a soil matrix, and is returned to the storm drain system.
Open Channels	Dry Swale (O-1)	An open drainage channel or depression explicitly designed to detain and promote the filtration of stormwater runoff into the soil media.
	Wet Swale (O-2)	An open drainage channel or depression designed to retain water or intercept groundwater for water quality treatment.

## **Section 5.2 Structural Practices Suitable for Pretreatment or as Supplemental Practices Only**

Several practices that are not capable of providing water quality treatment can nonetheless function in a pretreatment role or as a supplemental practice to the recommended practices in Table 5.1. These practices can often be incorporated into SMP design as pretreatment devices, to treat a small portion of a site, or in retrofit or redevelopment applications. Some of these practices, including dry ponds and underground storage vaults, can be used to meet water quantity goals such as channel protection and flood control requirements. In addition, some of these practices may be helpful to reduce the total volume of runoff from a site or to disconnect impervious surfaces, as indicated on the Fact Sheets presented in this chapter. Some practices not currently deemed effective for stand-alone water quality treatment include:

- Catch basin inserts
- Dry ponds
- Underground vaults (designed for flood control)
- Oil/grit separators and hydrodynamic structures
- Filter strips
- Grass channels (includes ditches designed primarily for conveyance as well as modified practices that can achieve some pollutant removal)
- Deep sump catch basins
- On-line storage in the storm drain network
- Porous pavement

Fact sheets for some of these practices (dry ponds, filter strips, porous pavement, and grass channels) have been provided following section 5.3.

## **Section 5.3 Criteria for Practice Addition**

The stormwater field is always evolving, and new technologies constantly emerge. New practices can be included in future revisions to the stormwater design manual, provided they can prove that they meet the water quality goals established in the manual. These goals include the 80% TSS (defined as suspended organic and inorganic material) and 40% TP removal target and a proven record of longevity in the field. For a practice to receive consideration for addition to the manual, the following monitoring criteria must be met by supporting studies:

- Must be monitored in at least two locations.
- At least five storm events must be sampled at each site.
- Concentrations reported in the studies must be flow-weighted.
- The studies must be independent (i.e., may not be conducted by the vendor or designer).
- The studies must be conducted in the field, as opposed to laboratory testing.

- The practice must have been in the ground for at least one year at the time of monitoring (to assume the practice will be tested after a minimum amount of "in-service" time).
- At least one storm event in each study must be greater than the 90% storm event for the location.

Additional testing for new technologies based on the performance of practices with a similar design may be required before consideration. For example, if a practice has a very similar design to an oil/grit separator, which has consistently poor removal, then additional studies may be required to justify incorporation of that practice into the manual. The long-term performance of a practice based on field applications in New York or other regions with a similar climate or conditions may also determine if that practice will receive consideration for inclusion in the manual. A poor maintenance record is a valid justification for not including a practice in the manual.

## Dry Ponds



**Description:** Dry extended detention ponds (a.k.a. dry ponds, extended detention basins, detention ponds, extended detention ponds) are basins designed to temporarily detain runoff for some minimum time. Dry detention ponds are used for water quantity control only, and can also be used to provide flood control by including additional flood detention storage.

<p style="text-align: center;"><b><u>REASONS FOR LIMITED USE</u></b></p> <ul style="list-style-type: none"> <li>• Controls stormwater quantity – not intended to provide water quality treatment</li> </ul> <p style="text-align: center;"><b><u>KEY CONSIDERATIONS</u></b></p> <ul style="list-style-type: none"> <li>• Applicable for drainage areas up to 75 acres</li> <li>• Typically less costly than stormwater (wet) ponds for equivalent flood storage, as less excavation is required</li> <li>• May provide recreational and open space opportunities between storm runoff events</li> </ul>	<p style="text-align: center;"><b><u>STORMWATER MANAGEMENT SUITABILITY</u></b></p> <p><input type="checkbox"/> Water Quality</p> <p><input checked="" type="checkbox"/> Channel/Flood Protection</p> <p style="text-align: center;"><b><u>SPECIAL APPLICATIONS</u></b></p> <p><input type="checkbox"/> Pretreatment</p> <p><input type="checkbox"/> High Density/Ultra-Urban</p> <p><input type="checkbox"/> Runoff Reduction/Impervious Cover Disconnection</p> <p><b>Residential Subdivision Use: Yes</b></p>
---	---



## Filter Strip



**Description:** Grassed filter strips (a.k.a., vegetated filter strips, filter strips, and grassed filters) are vegetated surfaces that are designed to treat sheet flow from adjacent surfaces and remove pollutants through filtration and infiltration.

<p style="text-align: center;"><b><u>REASONS FOR LIMITED USE</u></b></p> <ul style="list-style-type: none"> <li>• Cannot alone achieve the 80% TSS removal target</li> </ul> <p style="text-align: center;"><b><u>KEY CONSIDERATIONS</u></b></p> <ul style="list-style-type: none"> <li>• Runoff from an adjacent impervious area must be evenly distributed across the filter strip (i.e., sheet flow)</li> <li>• Can be used as part of the runoff conveyance system to provide pretreatment</li> <li>• Can provide groundwater recharge</li> <li>• Reasonably low construction cost</li> <li>• Large land requirement</li> <li>• Requires periodic repair, regrading, and sediment removal to prevent channelization</li> <li>• To size this practice, design a berm at the base of the filter strip. The volume to be treated should be captured behind the berm.</li> </ul>	<p style="text-align: center;"><b><u>STORMWATER MANAGEMENT SUITABILITY</u></b></p> <p><input type="checkbox"/> Water Quality</p> <p><input type="checkbox"/> Channel/Flood Protection</p> <p style="text-align: center;"><b><u>SPECIAL APPLICATIONS</u></b></p> <p><input checked="" type="checkbox"/> Pretreatment</p> <p><input type="checkbox"/> High Density/Ultra-Urban</p> <p><input checked="" type="checkbox"/> Runoff Reduction / Impervious Cover Disconnection</p> <p><input checked="" type="checkbox"/> Other: Use in buffer system; treating runoff from pervious areas</p> <p><b>Residential Subdivision Use: Yes</b></p>
--	--

## Modular Block Porous Pavement



**Description:** Modular block porous pavement is a permeable pavement surface with an underlying stone reservoir designed to temporarily store surface runoff before it infiltrates into the subsoil. Porous pavement options are primarily intended for low vehicle traffic areas such as spillover parking or simply the parking aisle portion of a parking lot.

<p style="text-align: center;"><b><u>REASONS FOR LIMITED USE</u></b></p> <ul style="list-style-type: none"> <li>• Maintenance record is unclear, and pretreatment cannot be provided.</li> <li>• Should not be applied on parking lots that are sanded or salted for snow control.</li> </ul> <p style="text-align: center;"><b><u>DESIGN CONSIDERATIONS</u></b></p> <ul style="list-style-type: none"> <li>• Soil permeability between 0.5 and 3.0 inches per hour</li> <li>• Do not locate on slopes &gt; 15% or within fill soils</li> <li>• Site at least 3 feet above the seasonally high groundwater table, and at least 100 feet away from drinking water wells</li> <li>• Direct runoff from pervious or exposed areas away from pavement</li> <li>• Size the gravel trench using the same equation provided in Section 6.3 for infiltration trenches.</li> <li>• Provide conveyance for larger storms with raised inlet or perimeter gravel trench</li> <li>• Sediment-laden runoff must be directed away from the porous pavement</li> <li>• Maximum depth should not exceed 4 feet</li> <li>• Ensure that the upland drainage is fully stabilized after construction;</li> <li>• Use permanent sign(s) containing a short list of maintenance requirements</li> <li>• Do not use excavated stone reservoir as a sediment control device</li> <li>• Avoid compacting subsoils during construction</li> <li>• Ensure that paving dewaterers between storms</li> <li>• Periodically inspect the surface for deterioration or spalling</li> </ul>	<p style="text-align: center;"><b><u>STORMWATER MANAGEMENT SUITABILITY</u></b></p> <p><input type="checkbox"/> Water Quality</p> <p><input type="checkbox"/> Channel/Flood Protection</p> <p style="text-align: center;"><b><u>SPECIAL APPLICATIONS</u></b></p> <p><input type="checkbox"/> Pretreatment</p> <p><input checked="" type="checkbox"/> High Density/Ultra-Urban</p> <p><input checked="" type="checkbox"/> Runoff Reduction / Impervious Cover Disconnection</p> <p><input checked="" type="checkbox"/> Other: Overflow Parking</p>
--	--

## Grass Channel



**Description:** Vegetated channels designed to filter stormwater runoff and meet velocity targets for the water quality design storm and the two-year storm event.

<p style="text-align: center;"><b><u>REASONS FOR LIMITED USE</u></b></p> <ul style="list-style-type: none"> <li>• Cannot alone achieve the 80% TSS removal target</li> </ul> <p style="text-align: center;"><b><u>KEY CONSIDERATIONS</u></b></p> <ul style="list-style-type: none"> <li>• Can be used as part of the runoff conveyance system to provide pretreatment</li> <li>• Grass channels can act to partially infiltrate runoff from small storm events if underlying soils are pervious</li> <li>• Less expensive than curb and gutter systems</li> <li>• Should not be used on slopes greater than 4%; slopes between 1% and 2% recommended</li> <li>• Design as a parabola, or as a trapezoid with a bottom width of between 2' and 8', with 3:1 or flatter side slopes.</li> <li>• Provide sufficient length to retain the treatment volume in the system for 10 minutes, to flow at no greater than 1.0 fps, and at a depth of no greater than 4".</li> <li>• Design to maintain between 4.0 and 5.0 fps for the 2-year storm, and no greater than 7.0 fps for the 10-year storm event.</li> <li>• Size the channel to safely convey the 10-year storm event.</li> <li>• Size using Manning's Equation (US DOT, 1990). Use an "n" value of 0.15 for flow depths of 4" or smaller, and linearly increase to 0.03 for a depth of 12".</li> </ul>	<p style="text-align: center;"><b><u>STORMWATER MANAGEMENT SUITABILITY</u></b></p> <p><input type="checkbox"/> Water Quality</p> <p><input type="checkbox"/> Channel/Flood Protection</p> <p style="text-align: center;"><b><u>SPECIAL APPLICATIONS</u></b></p> <p><input checked="" type="checkbox"/> Pretreatment</p> <p><input type="checkbox"/> High Density/Ultra-Urban</p> <p><input checked="" type="checkbox"/> Runoff Reduction / Impervious Cover Disconnection</p> <p><input checked="" type="checkbox"/> Other: Curb and gutter replacement</p> <p><b>Residential Subdivision Use:</b> Yes</p>
--	--

# Chapter 6

## Performance Criteria

## Chapter 6: Performance Criteria

This chapter outlines performance criteria for five groups of structural stormwater management practices (SMPs) to meet water quality treatment goals. These include ponds, wetlands, infiltration practices, filtering systems and open channels. Each set of SMP performance criteria, in turn, is based on six performance goals:

### *Feasibility*

Identify site considerations that may restrict the use of a practice.

### *Conveyance*

Convey runoff to the practice in a manner that is safe, minimizes erosion and disruption to natural channels, and promotes filtering and infiltration.

### *Pretreatment*

Trap coarse elements before they enter the facility, thus reducing the maintenance burden and ensuring a long-lived practice.

### *Treatment Geometry*

Provide water quality treatment, through design elements that provide the maximum pollutant removal as water flows through the practice.

### *Environmental/Landscaping*

Reduce secondary environmental impacts of facilities through features that minimize disturbance of natural stream systems and comply with environmental regulations. Provide landscaping that enhances the pollutant removal and aesthetic value of the practice.

### *Maintenance*

Maintain the long-term performance of the practice through regular maintenance activities, and through design elements that ease the maintenance burden.

Cold climate regions of New York State may present special design considerations. Each section includes a summary of possible design modifications that address the primary concerns associated with the use of that SMP in cold climates. A more detailed discussion of cold climate modifications can be found in the publication *Stormwater BMP Design Supplement for Cold Climates* (Caraco & Claytor, 1997). In addition, Appendix I of this manual provides some sizing examples that incorporate cold climate design.

IMPORTANT NOTES:

ANY PRACTICE THAT CREATES A DAM IS REQUIRED TO FOLLOW THE GUIDANCE PRESENTED IN THE GUIDELINES FOR DESIGN OF DAMS AND MAY REQUIRE A PERMIT FROM THE NYSDEC. FOR THE MOST RECENT COPY OF THIS DOCUMENT, CONTACT THE NEW YORK STATE DEPARTMENT OF ENVIRONMENTAL CONSERVATION, DAM SAFETY DIVISION, AT: 518-402-8151. AN EVALUATION OF HAZARD CLASSIFICATION MUST BE INCLUDED IN THE DESIGN REPORT FOR STORMWATER PONDS OR WETLANDS CREATED BY A DAM.

THIS CHAPTER FOLLOWING TEXT PRESENTS CRITERIA IN TWO PARTS. DESIGN GUIDELINES ARE FEATURES THAT ENHANCE PRACTICE PERFORMANCE, BUT MAY NOT BE NECESSARY FOR ALL APPLICATIONS. REQUIRED ELEMENTS ARE FEATURES THAT SHOULD BE USED IN ALL APPLICATIONS. A FACT SHEET AT THE BACK OF EACH SECTION HIGHLIGHTS THE REQUIRED ELEMENTS.

APPENDICES F AND G PROVIDE EXAMPLE CHECKLISTS FOR THE CONSTRUCTION AND OPERATION&MAINTENANCE OF EACH OF THE PRACTICE TYPES.

**Section 6.1 Stormwater Ponds**

Stormwater ponds are practices that have either a permanent pool of water, or a combination of a permanent pool and extended detention, and some elements of a shallow marsh equivalent to the entire  $WQ_v$ . Five design variants include:

- P-1 Micropool Extended Detention Pond (Figure 6.1)
- P-2 Wet Pond (Figure 6.2)
- P-3 Wet Extended Detention Pond (Figure 6.3)
- P-4 Multiple Pond System (Figure 6.4)
- P-5 Pocket Pond (Figure 6.5)

**Treatment Suitability:**

Dry extended detention ponds without a permanent pool are not considered an acceptable option for meeting water quality treatment goals. Each of the five stormwater pond designs can be used to provide channel protection volume as well as overbank and extreme flood attenuation. The term "pocket" refers to a pond or wetland that has such a small contributing drainage area that little or no baseflow is available to sustain water elevations during dry weather. Instead, water elevations are heavily influenced, and in some cases maintained, by a locally high water table.

**IMPORTANT NOTES:**

ANY PRACTICE THAT CREATES A DAM IS REQUIRED TO FOLLOW THE GUIDANCE PRESENTED IN THE GUIDELINES FOR DESIGN OF DAMS AND MAY REQUIRE A PERMIT FROM THE NYSDEC. FOR THE MOST RECENT COPY OF THIS DOCUMENT, CONTACT THE NEW YORK STATE DEPARTMENT OF ENVIRONMENTAL CONSERVATION, DAM SAFETY DIVISION, AT: 518-402-8151. AN EVALUATION OF HAZARD CLASSIFICATION MUST BE INCLUDED IN THE DESIGN REPORT FOR STORMWATER PONDS CREATED BY A DAM.

WHILE THE STORMWATER PONDS DESIGNED ACCORDING TO THIS GUIDANCE MAY ACT AS A COMMUNITY AMMENITY, AND MAY PROVIDE SOME HABITAT VALUE, THEY CANNOT BE ANTICIPATED TO FUNCTION AS NATURAL LAKES OR PONDS.

Figure 6.1 Micropool Extended Detention Pond (P-1)

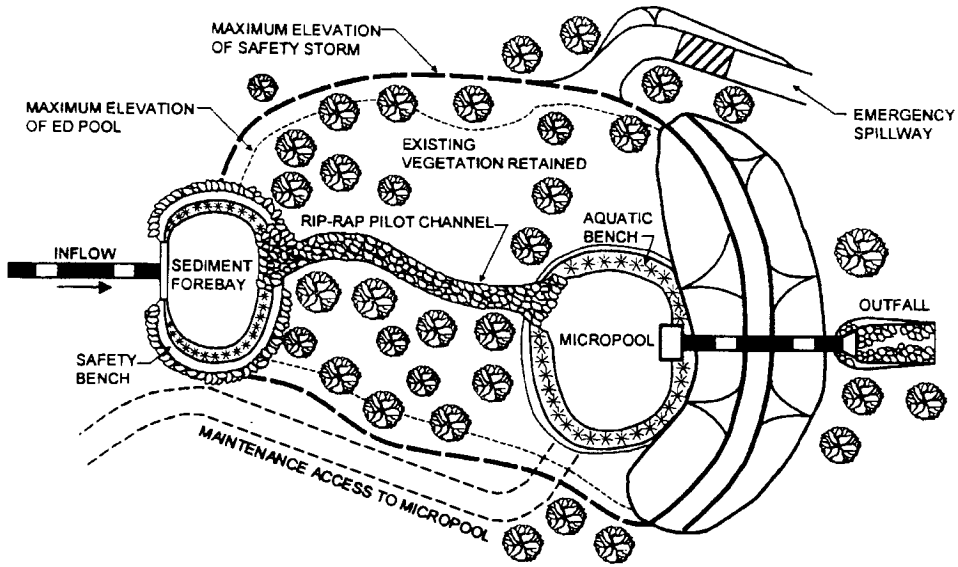

PLAN VIEW

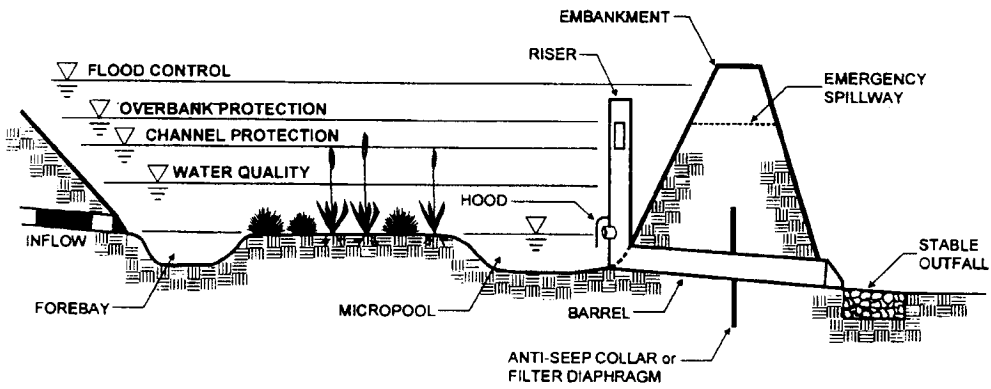

PROFILE



Figure 6.2 Wet Pond (P-2)

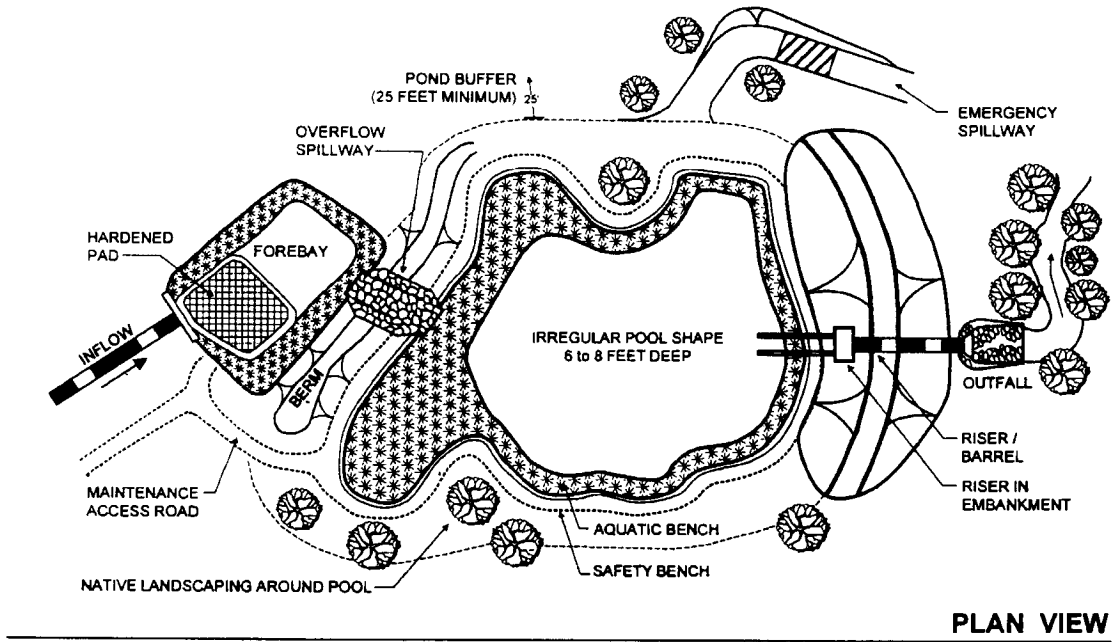

PLAN VIEW

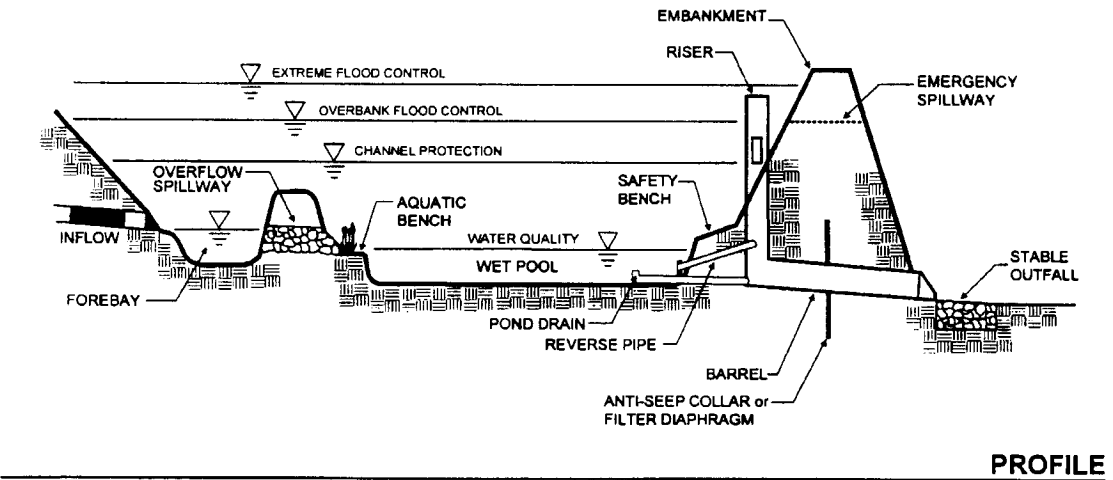

PROFILE

Figure 6.3 Wet Extended Detention Pond (P-3)

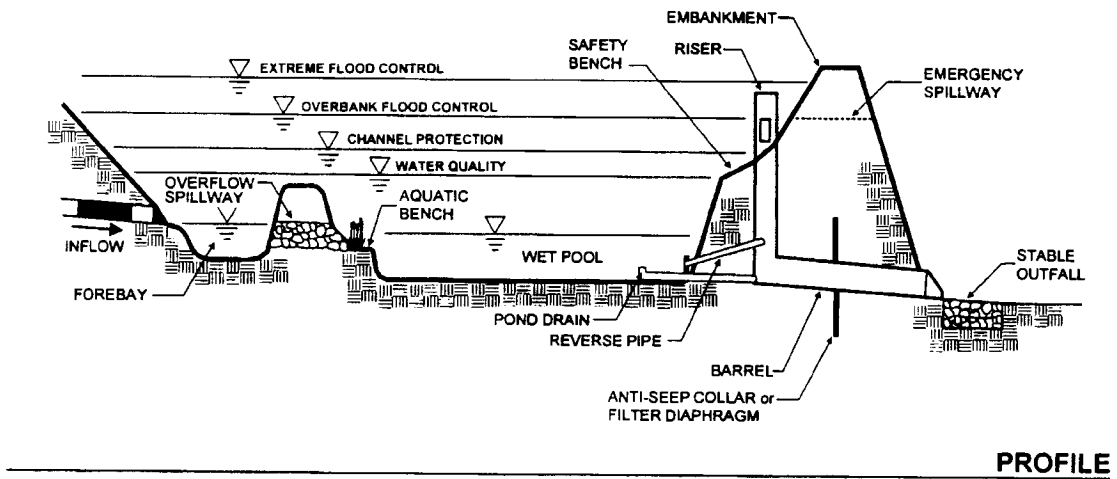
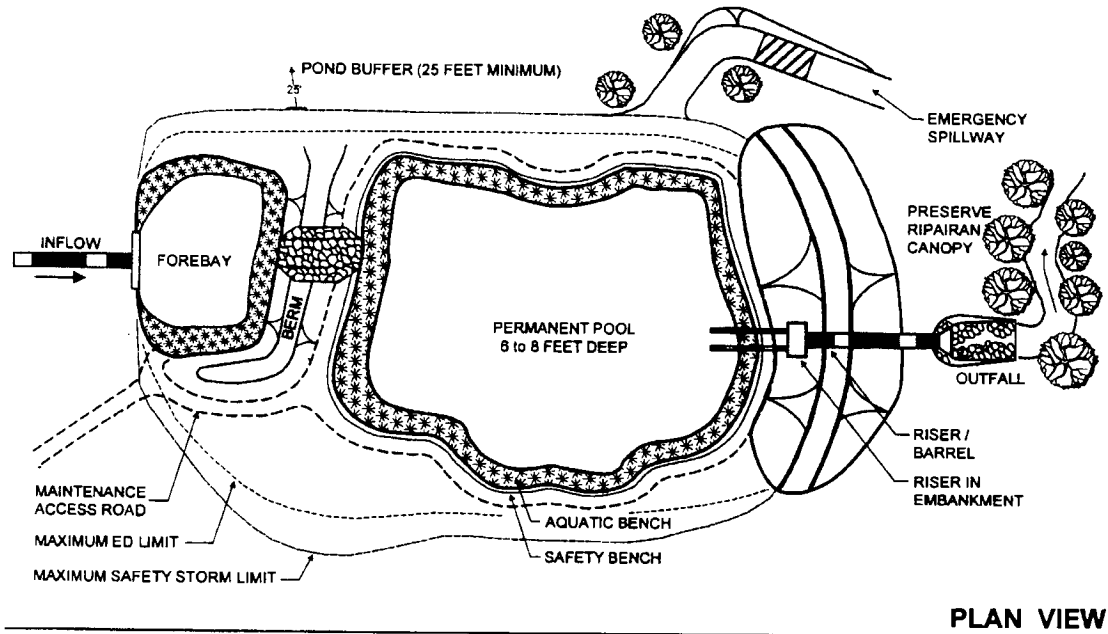
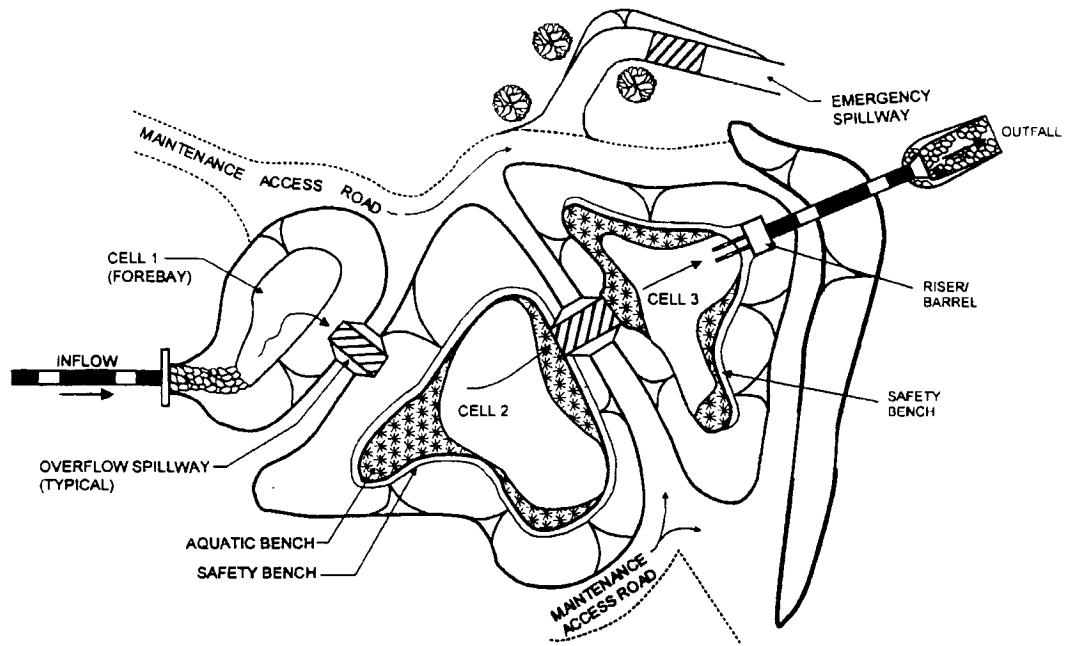
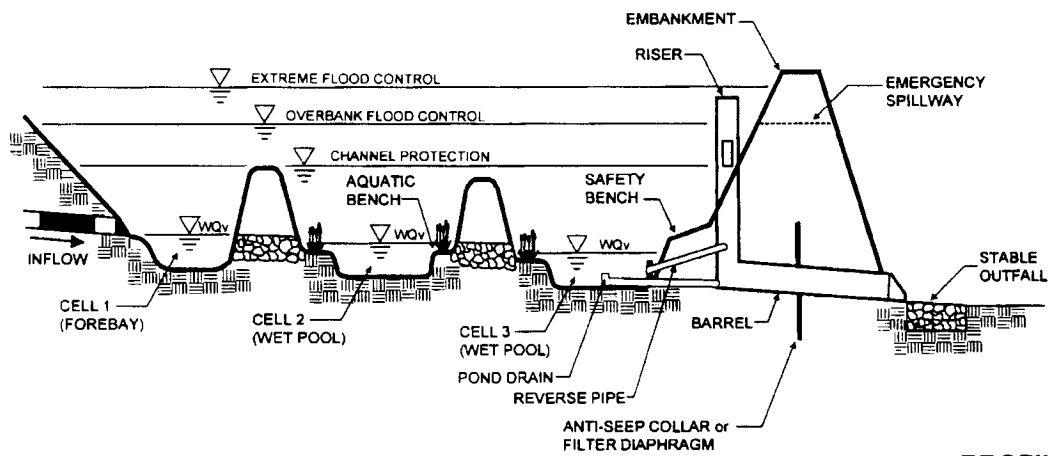

Figure 6.4 Multiple Pond System (P-4)



PLAN VIEW



PROFILE

Figure 6.5 Pocket Pond (P-5)

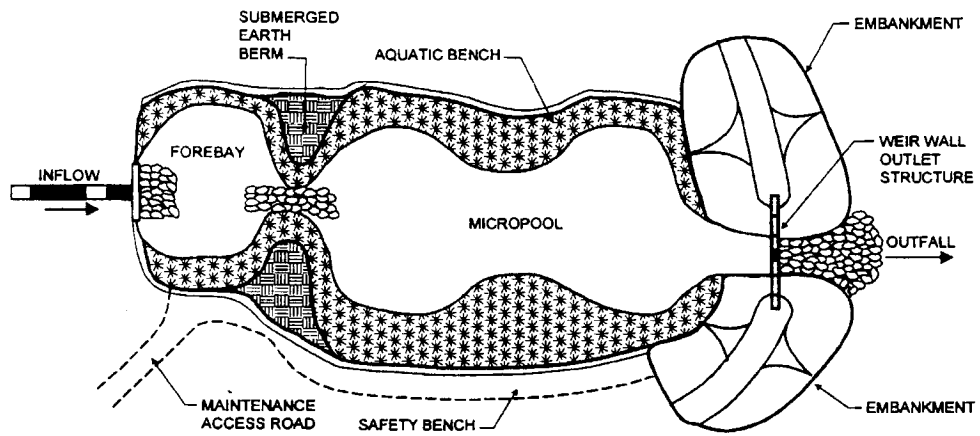

PLAN VIEW

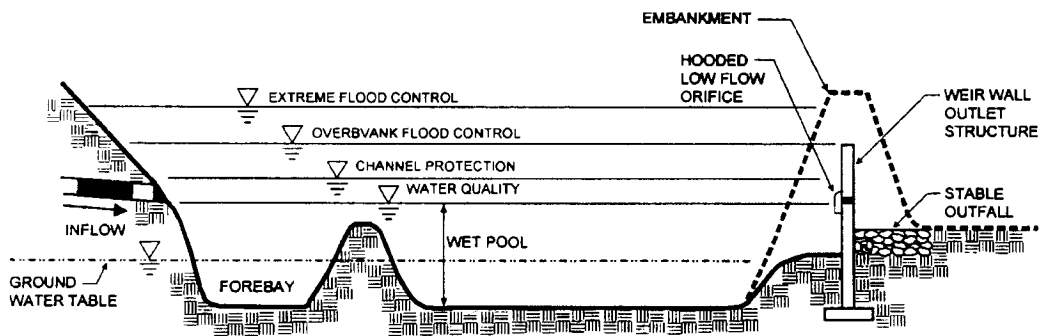

PROFILE

### 6.1.1 Feasibility

#### Required Elements

- Designs P-2, P-3, and P-4 shall have a minimum contributing drainage area of 25 acres. A 10-acre drainage is required for design P-1.
- Stormwater ponds shall not be located within jurisdictional waters, including wetlands.
- Evaluate the site to determine the Hazard Class, and to determine what design elements are required to ensure dam safety (see *Guidelines for Design of Dams*). For the most recent copy of this document, contact the New York State Department of Environmental Conservation, Dam Safety Division, at: 518-402-8151.
- Avoid direction of hotspot runoff to design P-5.
- Provide a 2' minimum separation between the pond bottom and groundwater in sole source aquifer recharge areas.

#### Design Guidance

- The use of stormwater ponds (with the exception of design P-1, Micropool Extended Detention Pond) on trout waters is strongly discouraged, as available evidence suggests that these practices can increase stream temperatures.
- Avoid location of pond designs within the stream channel, to prevent habitat degradation caused by these structures.
- A maximum drainage area of five acres is suggested for design P-5.

### 6.1.2 Conveyance

#### **Inlet Protection**

#### Required Elements

- A forebay shall be provided at each pond inflow point, unless an inflow point provides less than 10% of the total design storm flow to the pond.

#### Design Guidance

- Inlet areas should be stabilized to ensure that non-erosive conditions exist for at least the 2-year frequency storm event.

- Except in cold regions of the State, the ideal inlet configuration is a partially submerged (i.e., ½ full) pipe.

### **Adequate Outfall Protection**

#### Required Elements

- The channel immediately below a pond outfall shall be modified to prevent erosion and conform to natural dimensions in the shortest possible distance, typically by use of appropriately-sized riprap placed over filter cloth. Typical examples include submerged earthen berms, concrete weirs, and gabion baskets.
- A stilling basin or outlet protection shall be used to reduce flow velocities from the principal spillway to non-erosive velocities (3.5 to 5.0 fps). (See Appendix L for a table of erosive velocities for grass and soil).

#### Design Guidance

- Outfalls should be constructed such that they do not increase erosion or have undue influence on the downstream geomorphology of the stream.
- Flared pipe sections that discharge at or near the stream invert or into a step-pool arrangement should be used at the spillway outlet.
- If a pond daylights to a channel with dry weather flow, care should be taken to minimize tree clearing along the downstream channel, and to reestablish a forested riparian zone in the shortest possible distance. Excessive use of riprap should be avoided to reduce stream warming.

### **Pond Liners**

#### Design Guidance

- When a pond is located in gravelly sands or fractured bedrock, a liner may be needed to sustain a permanent pool of water. If geotechnical tests confirm the need for a liner, acceptable options include: (a) six to 12 inches of clay soil (minimum 15% passing the #200 sieve and a minimum permeability of  $1 \times 10^{-5}$  cm/sec), (b) a 30 ml poly-liner (c) bentonite, (d) use of chemical additives (see *NRCS Agricultural Handbook No. 386*, dated 1961, or *Engineering Field Manual*) or (e) a design prepared by a Professional Engineer registered in the State of New York.

6.1.3 Pretreatment

Required Elements

- A sediment forebay is important for maintenance and longevity of a stormwater treatment pond. Each pond shall have a sediment forebay or equivalent upstream pretreatment. The forebay shall consist of a separate cell, formed by an acceptable barrier. Typical examples include earthen berms, concrete weirs, and gabion baskets.
- The forebay shall be sized to contain 10% of the water quality volume (WQ<sub>v</sub>), and shall be four to six feet deep. The forebay storage volume counts toward the total WQ<sub>v</sub> requirement.
- The forebay shall be designed with non-erosive outlet conditions, given design exit velocities.
- Direct access for appropriate maintenance equipment shall be provided to the forebay.
- In sole source aquifers, 100% of the WQ<sub>v</sub> for stormwater runoff from designated hotspots shall be provided in pretreatment.

Design Guidance

- A fixed vertical sediment depth marker should be installed in the forebay to measure sediment deposition over time.
- The bottom of the forebay may be hardened to ease sediment removal

6.1.4 Treatment

**Minimum Water Quality Volume (WQ<sub>v</sub>)**

Required Elements

- Provide water quality treatment storage to capture the computed WQ<sub>v</sub> from the contributing drainage area through a combination of permanent pool, extended detention (WQ<sub>v</sub>-ED) and marsh. The division of storage into permanent pool and extended detention is outlined in Table 6.1.

Table 6.1 Water Quality Volume Distribution in Pond Designs		
Design Variation	%WQ <sub>v</sub>	
	Permanent Pool	Extended Detention
P-1	20% min.	80% max.
P-2	100%	0%
P-3	50% min.	50% max.
P-4	50% min.	50% max.
P-5	50% min.	50% max.

- Although both  $CP_v$  and  $WQ_v$ -ED storage can be provided in the same practice,  $WQ_v$  cannot be met by simply providing  $Cp_v$  storage for the one-year storm.

#### Design Guidance

- It is generally desirable to provide water quality treatment off-line when topography, hydraulic head and space permit (i.e., apart from stormwater quantity storage; see Appendix K for a schematic).
- Water quality storage can be provided in multiple cells. Performance is enhanced when multiple treatment pathways are provided by using multiple cells, longer flowpaths, high surface area to volume ratios, complex microtopography, and/or redundant treatment methods (combinations of pool, ED, and marsh).

### **Minimum Pond Geometry**

#### Required Elements

- The minimum length to width ratio for the pond is 1.5:1 (i.e., length relative to width).
- Provide a minimum Surface Area:Drainage Area of 1:100.

#### Design Guidance

- To the greatest extent possible, maintain a long flow path through the system, and design ponds with irregular shapes.

#### *6.1.5 Landscaping*

### **Pond Benches**

#### Required Elements

- The perimeter of all deep pool areas (four feet or greater in depth) shall be surrounded by two benches:
  - Except when pond side slopes are 4:1 (h:v) or flatter, provide a safety bench that generally extends 15 feet outward (10' to 12' allowable on sites with extreme space limitations) from the normal water edge to the toe of the pond side slope. The maximum slope of the safety bench shall be 6%; *and*



- Incorporate an aquatic bench that generally extends up to 15 feet inward from the normal shoreline, has an irregular configuration, and a maximum depth of 18 inches below the normal pool water surface elevation.

### **Landscaping Plan**

#### Required Elements

- A landscaping plan for a stormwater pond and its buffer shall be prepared to indicate how aquatic and terrestrial areas will be vegetatively stabilized and established.

#### Design Guidance

- Wherever possible, wetland plants should be encouraged in a pond design, either along the aquatic bench (fringe wetlands), the safety bench and side slopes (ED wetlands) or within shallow areas of the pool itself.
- The best elevations for establishing wetland plants, either through transplantation or volunteer colonization, are within six inches (plus or minus) of the normal pool.
- The soils of a pond buffer are often severely compacted during the construction process to ensure stability. The density of these compacted soils is so great that it effectively prevents root penetration, and therefore, may lead to premature mortality or loss of vigor. Consequently, it is advisable to excavate large and deep holes around the proposed planting sites, and backfill these with uncompacted topsoil.
  - As a rule of thumb, planting holes should be three times deeper and wider than the diameter of the rootball (of balled and burlap stock), and five times deeper and wider for container grown stock. This practice should enable the stock to develop unconfined root systems. Avoid species that require full shade, are susceptible to winterkill, or are prone to wind damage. Extra mulching around the base of the tree or shrub is strongly recommended as a means of conserving moisture and suppressing weeds.

## **Pond Buffers and Setbacks**

### Required Elements

- A pond buffer shall be provided that extends 25 feet outward from the maximum water surface elevation of the pond. The pond buffer shall be contiguous with other buffer areas that are required by existing regulations (e.g., stream buffers). An additional setback may be provided to permanent structures.
- Woody vegetation may not be planted or allowed to grow within 15 feet of the toe of the embankment and 25 feet from the principal spillway structure.

### Design Guidance

- Existing trees should be preserved in the buffer area during construction. It is desirable to locate forest conservation areas adjacent to ponds. To help discourage resident geese populations, the buffer can be planted with trees, shrubs and native ground covers.
- Annual mowing of the pond buffer is only required along maintenance rights-of-way and the embankment. The remaining buffer can be managed as a meadow (mowing every other year) or forest.

#### *6.1.6 Maintenance*

### Required Elements

- Maintenance responsibility for a pond and its buffer shall be vested with a responsible authority by means of a legally binding and enforceable maintenance agreement that is executed as a condition of plan approval.
- The principal spillway shall be equipped with a removable trash rack, and generally accessible from dry land.
- Sediment removal in the forebay shall occur every five to six years or after 50% of total forebay capacity has been lost.

### Design Guidance

- Sediments excavated from stormwater ponds that do not receive runoff from designated hotspots are generally not considered toxic or hazardous material, and can be safely disposed by either land application or land filling. Sediment testing may be required prior to sediment disposal when a hotspot land use is present (see Section 4.8 for a list of potential hotspots).

- Sediment removed from stormwater ponds should be disposed of according to an approved comprehensive operation and maintenance plan.

### **Maintenance Access**

#### Required Elements

- A maintenance right of way or easement shall extend to the pond from a public or private road.

#### Design Guidance

- Maintenance access should be at least 12 feet wide, have a maximum slope of no more than 15%, and be appropriately stabilized to withstand maintenance equipment and vehicles.
- The maintenance access should extend to the forebay, safety bench, riser, and outlet and be designed to allow vehicles to turn around.

### **Non-clogging Low Flow Orifice**

#### Required Elements

- A low flow orifice shall be provided, with the size for the orifice sufficient to ensure that no clogging shall occur. (See Appendix K for details of a low flow orifice and trash rack options).

#### Design Guidance

- The low flow orifice should be adequately protected from clogging by either an acceptable external trash rack (recommended minimum orifice of 3") or by internal orifice protection that may allow for smaller diameters (recommended minimum orifice of 1").
- The preferred method is a submerged reverse-slope pipe that extends downward from the riser to an inflow point one foot below the normal pool elevation.
- Alternative methods are to employ a broad crested rectangular, V-notch, or proportional weir, protected by a half-round CMP that extends at least 12 inches below the normal pool.
- The use of horizontally extended perforated pipe protected by geotextile fabric and gravel is not recommended. Vertical pipes may be used as an alternative if a permanent pool is present.

### **Riser in Embankment**

#### Required Elements

- The riser shall be located within the embankment for maintenance access, safety and aesthetics.

#### Design Guidance

- Access to the riser should be provided by lockable manhole covers, and manhole steps within easy reach of valves and other controls. The principal spillway opening should be "fenced" with pipe or rebar at 8-inch intervals (for safety purposes).

### **Pond Drain**

#### Required Elements

- Except where local slopes prohibit this design, each pond shall have a drain pipe that can completely or partially drain the pond. The drain pipe shall have an elbow or protected intake within the pond to prevent sediment deposition, and a diameter capable of draining the pond within 24 hours.

#### Design Guidance

- Care should be exercised during pond drawdowns to prevent rapid drawdown and minimize downstream discharge of sediments or anoxic water. The approving jurisdiction should be notified before draining a pond.

### **Adjustable Gate Valve**

#### Required Elements

- Both the WQ<sub>v</sub>-ED pipe and the pond drain shall be equipped with an adjustable gate valve (typically a handwheel activated knife gate valve).
- Valves shall be located inside of the riser at a point where they (a) will not normally be inundated and (b) can be operated in a safe manner.

#### Design Guidance

- Both the WQ<sub>v</sub>-ED pipe and the pond drain should be sized one pipe size greater than the calculated design diameter.

- To prevent vandalism, the handwheel should be chained to a ringbolt, manhole step or other fixed object.

### Safety Features

#### Required Elements

- Side slopes to the pond shall not exceed 3:1 (h:v), and shall terminate at a safety bench.
- The principal spillway opening shall not permit access by small children, and endwalls above pipe outfalls greater than 48 inches in diameter shall be fenced to prevent a hazard.

#### Design Guidance

- Both the safety bench and the aquatic bench may be landscaped to prevent access to the pool.
- Warning signs prohibiting swimming and skating may be posted.
- Pond fencing is generally not encouraged, but may be required by some municipalities. A preferred method is to manage the contours of the pond to eliminate dropoffs or other safety hazards.

#### *6.1.7 Cold Climate Pond Design Considerations*

Inlets, outlet structures and outfall protection for pond systems require modifications to function well in cold climates. Among the problems those wishing to use stormwater ponds in cold climates may encounter are:

- Higher runoff volumes and increased pollutant loads during the spring melt
- Pipe freezing and clogging
- Ice formation on the permanent pool
- Road sand build-up

#### Higher runoff volumes and increased pollutant loads during the spring melt

- Operate the pond based on seasonal inputs by adjusting dual water quality outlets to provide additional storage (see Figure 6.6).
- Adapt sizing based on snowmelt characteristics (see Appendix I).
- Do not drain ponds during the spring season. Due to temperature stratification and high chloride concentrations at the bottom, the water may become highly acidic and anoxic and may cause negative downstream effects.

Pipe Freezing and Clogging

- Inlet pipes should not be submerged, since this can result in freezing and upstream damage or flooding.
- Bury all pipes below the frost line to prevent frost heave and pipe freezing. Bury pipes at the point furthest from the pond deeper than the frost line to minimize the length of pipe exposed.
- Increase the slope of inlet pipes to a minimum of 1% to prevent standing water in the pipe, reducing the potential for ice formation. This design may be difficult to achieve at sites with flat local slopes.
- If perforated riser pipes are used, the minimum orifice diameter should be ½". In addition, the pipe should have a minimum 6" diameter.
- When a standard weir is used, the minimum slot width should be 3", especially when the slot is tall.
- Baffle weirs can prevent ice formation near the outlet by preventing surface ice from blocking the inlet, encouraging the movement of baseflow through the system (see Appendix K).
- In cold climates, riser hoods and reverse slope pipes should draw from at least 6" below the typical ice layer. This design encourages circulation in the pond, preventing stratification and formation of ice at the outlet.
- Trash racks should be installed at a shallow angle to prevent ice formation (see Appendix K).

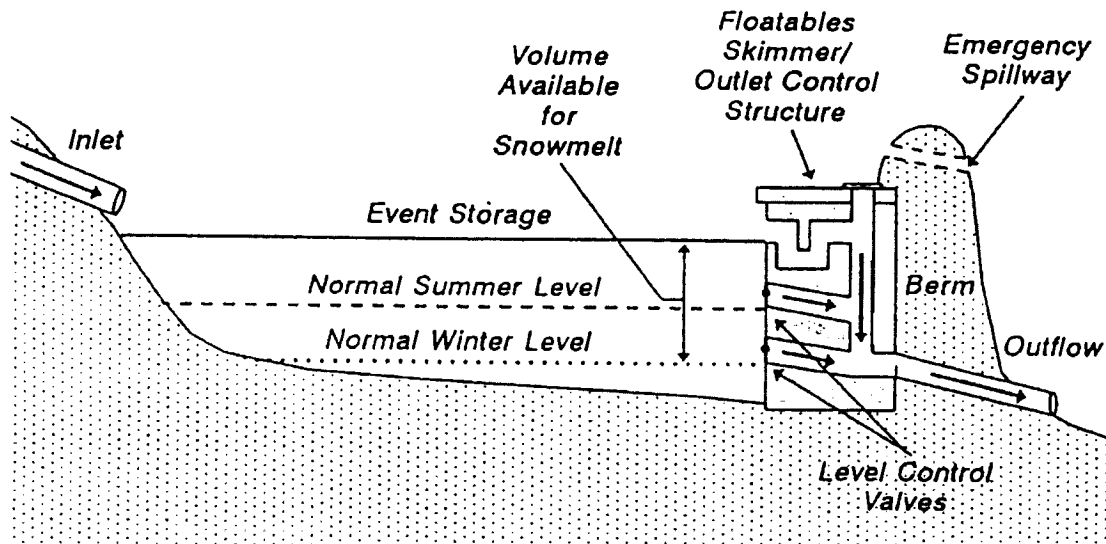
**Figure 6.6 Seasonal Operation Pond**

#### Ice Formation on the Permanent Pool

- In cold climates, the treatment volume of a pond system should be adjusted to account for ice build-up on the permanent pool by providing one foot of elevation above the  $WQ_v$ . The total depth of the pond, including this additional elevation, should not exceed eight feet.
- Using pumps or bubbling systems can reduce ice build-up and prevent the formation of an anaerobic zone in pond bottoms.
- Provide some storage as extended detention. This recommendation is made for very cold climates to provide detention while the permanent pond is iced over. In effect, it discourages the use of wet ponds (P-2), replacing them with wet extended detention ponds (P-3).
- Multiple pond systems are recommended regardless of climate because they provide redundant treatment options. In cold climates, a berm or simple weir should be used instead of pipes to separate multiple ponds, due to their higher freezing potential.

#### Road Sand Build-up

- In areas where road sand is used, an inspection of the forebay and pond should be scheduled after the spring melt to determine if dredging is necessary. For forebays, dredging is needed if one half of the capacity of the forebay is full.

## Stormwater Ponds



**Description:**

Constructed stormwater retention basin that has a permanent pool (or micropool). Runoff from each rain event is detained and treated in the pool through settling and biological uptake mechanisms.

**Design Options:**

Micropool Extended Detention (P-1), Wet Pond (P-2), Wet Extended Detention (P-3), Multiple Pond (P-4), Pocket Pond (P-5)

**KEY CONSIDERATIONS**

**FEASIBILITY**

- Contributing drainage area greater than 10 acres for P-1, 25 acres for P-2 to P-4.
- Follow DEC Guidelines for Design of Dams.
- Provide a minimum 2' separation from the groundwater in sole source aquifers.
- Do not locate ponds in jurisdictional wetlands.
- Avoid directing hotspot runoff to design P-5.

**CONVEYANCE**

- Forebay at each inlet, unless the inlet contributes less than 10% of the total inflow, 4' to 6' deep.
- Stabilize the channel below the pond to prevent erosion.
- Stilling basin at the outlet to reduce velocities.

**PRETREATMENT**

- Forebay volume at least 10% of the WQ<sub>v</sub>
- Forebay shall be designed with non-erosive outlet conditions.
- Provide direct access to the forebay for maintenance equipment
- In sole source aquifers, provide 100% pretreatment for hotspot runoff.

**TREATMENT**

- Provide the water quality volume in a combination of permanent pool and extended detention (Table 6.1 in manual provides limitations on storage breakdown)
- Minimum length to width ratio of 1.5:1
- Minimum surface area to drainage area ratio of 1:100

**LANDSCAPING**

- Provide a minimum 10' and preferably 15' safety bench extending from the high water mark, with a maximum slope of 6%.
- Provide an aquatic bench extending 15 feet outward from the shoreline, and a maximum depth of 18" below normal water elevation.
- Develop a landscaping plan.
- Provide a 25'pond buffer.
- No woody vegetation within 15 feet of the toe of the embankment, or 25 feet from the principal spillway.

**STORMWATER MANAGEMENT SUITABILITY**

- Water Quality**
- Channel Protection**
- Overbank Flood Protection**
- Extreme Flood Protection**

**Accepts Hotspot Runoff: Yes**  
(2 feet minimum separation distance required to water table)

**FEASIBILITY CONSIDERATIONS**

- Cost**
- Maintenance Burden**

**Key: L=Low M=Moderate H=High**

**Residential Subdivision Use: Yes**  
**High Density/Ultra-Urban: No**

**Soils: Hydrologic group 'A' soils may require pond liner**

**Hydrologic group 'D' soils may have compaction constraints**

**Other Considerations:**

- Thermal effects
- Outlet clogging
- Safety bench



<p><b>MAINTENANCE REQUIREMENTS</b></p> <ul style="list-style-type: none"> <li>• Legally binding maintenance agreement</li> <li>• Sediment removal from forebay every five to six years or when 50% full.</li> <li>• Provide a maintenance easement and right-of-way.</li> <li>• Removable trash rack on the principal spillway.</li> <li>• Non-clogging low flow orifice</li> <li>• Riser in the embankment.</li> <li>• Pond drain required, capable of drawing down the pond in 24 hours.</li> <li>• Notification required for pond drainage.</li> <li>• Provide an adjustable gate valve on both the WQ<sub>v</sub>-ED pipe, and the pond drain.</li> <li>• Side Slopes less than 3:1, and terminate at a safety bench.</li> <li>• Principal spillway shall not permit access by small children, and endwalls above pipes greater than 48" in diameter shall be fenced.</li> </ul>	<p><b>POLLUTANT REMOVAL</b></p> <p><b>G</b> Phosphorus</p> <p><b>G</b> Nitrogen</p> <p><b>G</b> Metals - Cadmium, Copper, Lead, and Zinc removal</p> <p><b>G</b> Pathogens Coliform, E.Coli, Streptococci removal</p> <p><b>Key: G=Good F=Fair P=Poor</b></p>
--	---

**Section 6.2 Stormwater Wetlands**

Stormwater wetlands are practices that create shallow marsh areas to treat urban stormwater and often incorporate small permanent pools and/or extended detention storage to achieve the full WQv. Design variants include:

- W-1 Shallow Wetland (Figure 6.7)
- W-2 ED Shallow Wetland (Figure 6.8)
- W-3 Pond/Wetland System (Figure 6.9)
- W-4 Pocket Wetland (Figure 6.10)

Wetland designs W-1 through W-4 can be used to provide Channel Protection volume as well as Overbank and Extreme Flood attenuation. In these design variations, the permanent pool is stored in a depression excavated into the ground surface. Wetland plants are planted at the wetland bottom, particularly in the shallow regions.

**IMPORTANT NOTES**

ALL OF THE POND CRITERIA PRESENTED IN PERFORMANCE CRITERIA – PONDS (CHAPTER 6.1) ALSO APPLY TO THE DESIGN OF STORMWATER WETLANDS. ADDITIONAL CRITERIA THAT GOVERN THE GEOMETRY AND ESTABLISHMENT OF CREATED WETLANDS ARE PRESENTED IN THIS SECTION.

ANY PRACTICE THAT CREATES A DAM IS REQUIRED TO FOLLOW THE GUIDANCE PRESENTED IN THE GUIDELINES FOR DESIGN OF DAMS AND MAY REQUIRE A PERMIT FROM THE NYSDEC. FOR THE MOST RECENT COPY OF THIS DOCUMENT, CONTACT THE NEW YORK STATE DEPARTMENT OF ENVIRONMENTAL CONSERVATION, DAM SAFETY DIVISION, AT: 518-402-8151. AN EVALUATION OF HAZARD CLASSIFICATION MUST BE INCLUDED IN THE DESIGN REPORT FOR STORMWATER WETLANDS CREATED BY A DAM.

WHILE THE STORMWATER WETLANDS DESIGNED ACCORDING TO THIS GUIDANCE MAY ACT AS A COMMUNITY AMMENITY, AND MAY PROVIDE SOME HABITAT VALUE, THEY CANNOT BE ANTICIPATED TO FUNCTION AS NATURAL WETLANDS

Figure 6.7 Shallow Wetland (W-1)

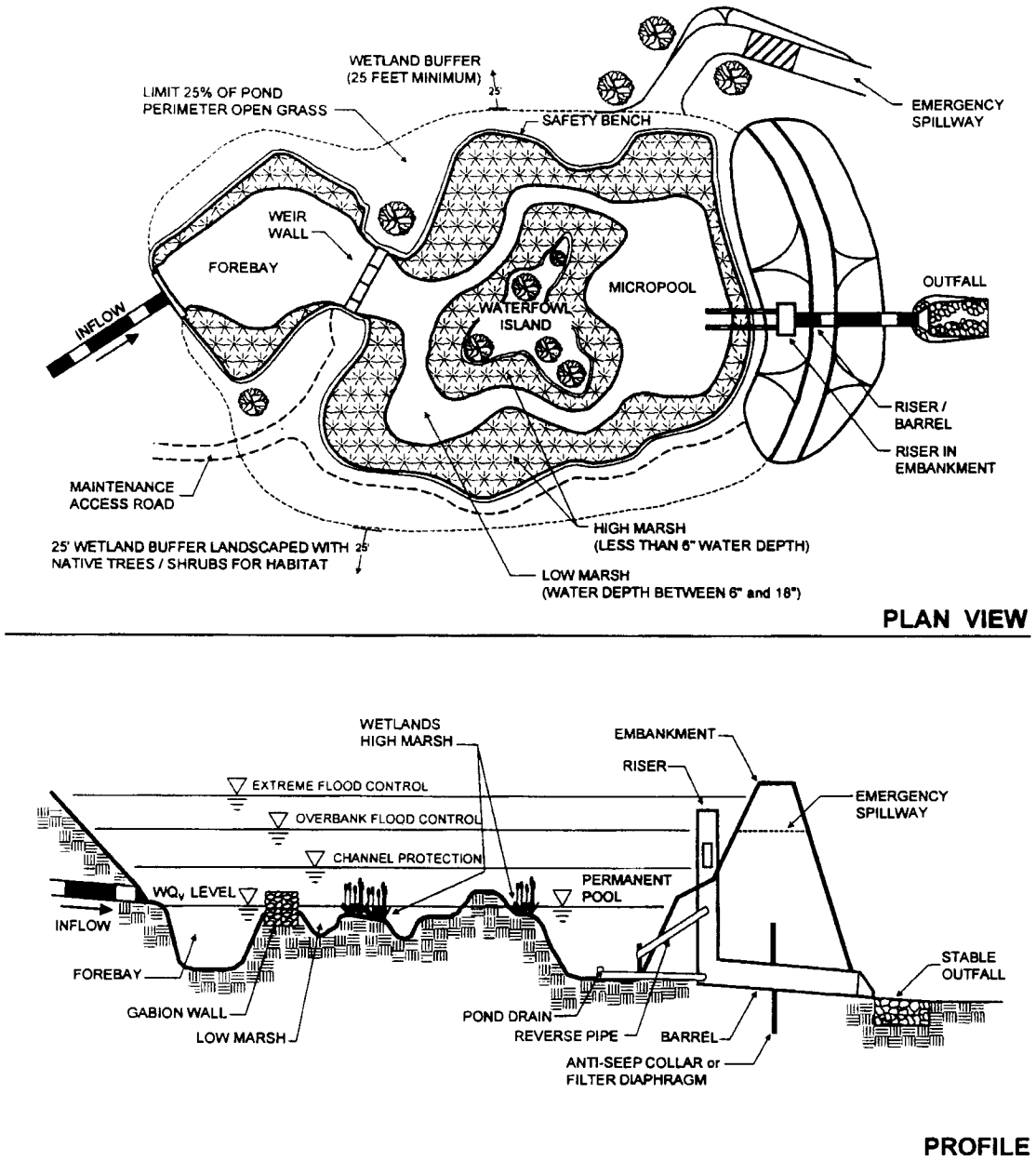
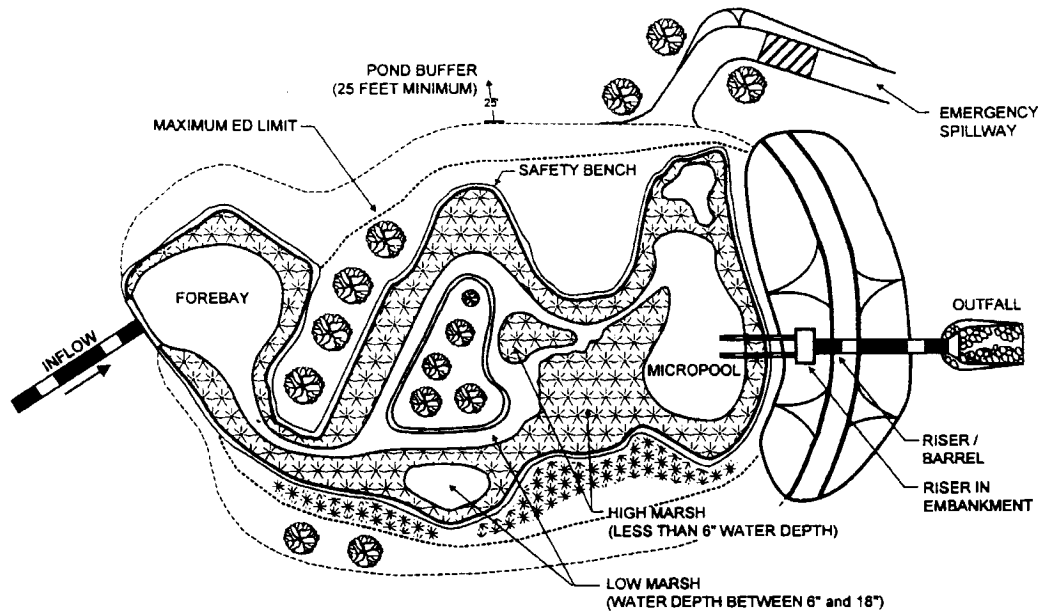
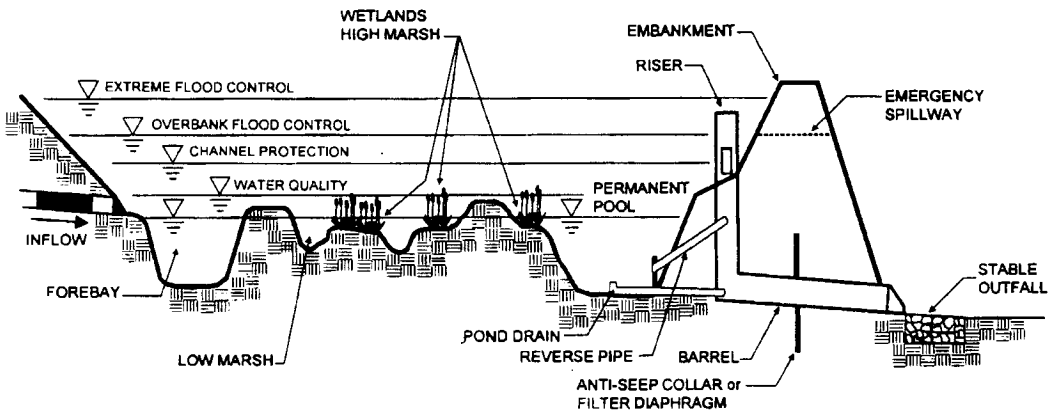

Figure 6.8 Extended Detention Shallow Wetland (W-2)



PLAN VIEW



PROFILE

Figure 6.9 Pond/Wetland System (W-3)

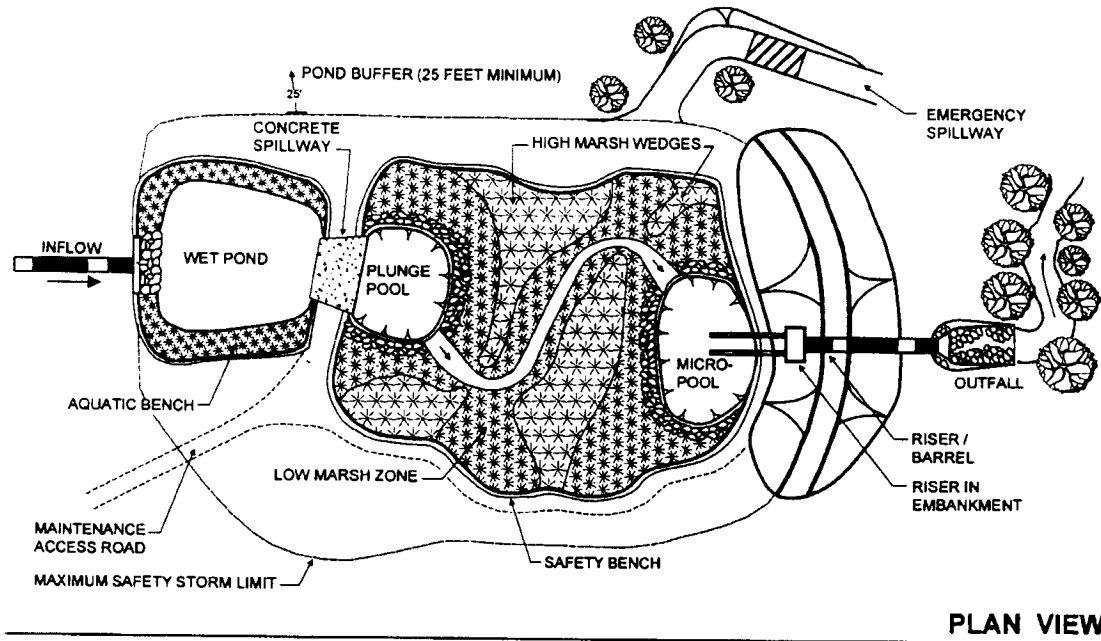

PLAN VIEW

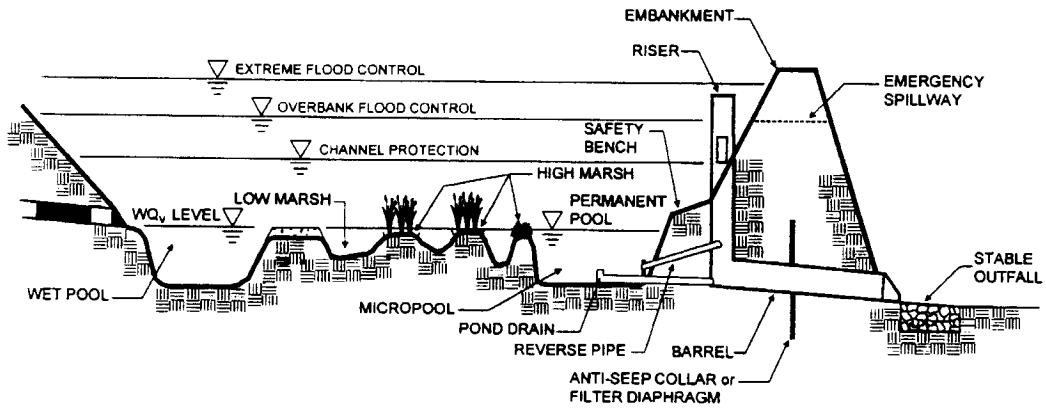

PROFILE

Figure 6.10 Pocket Wetland (W-4)

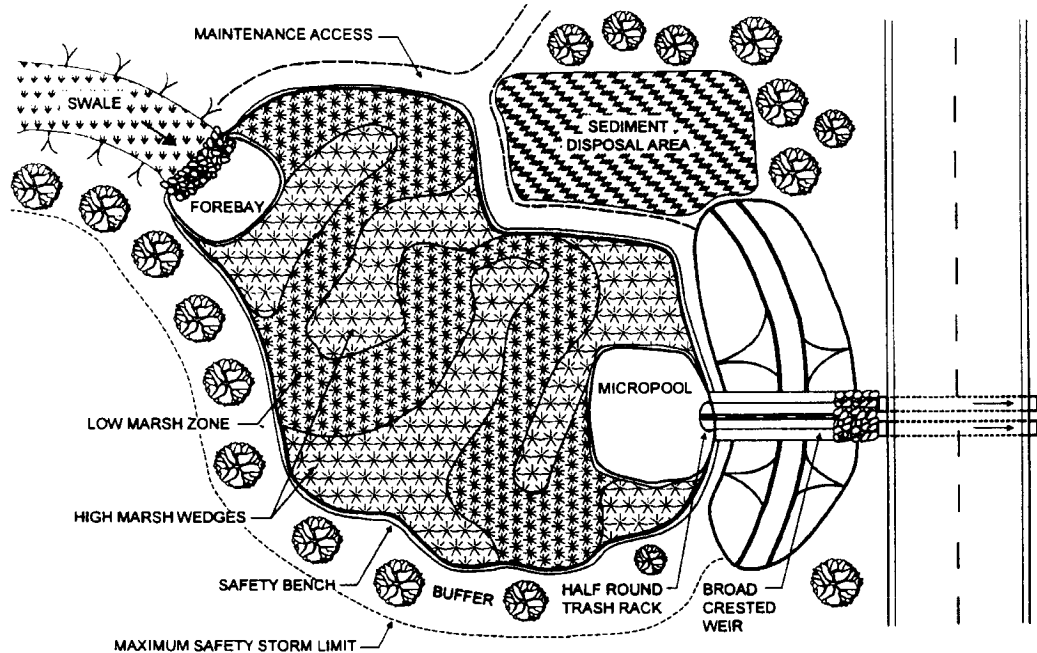

PLAN VIEW

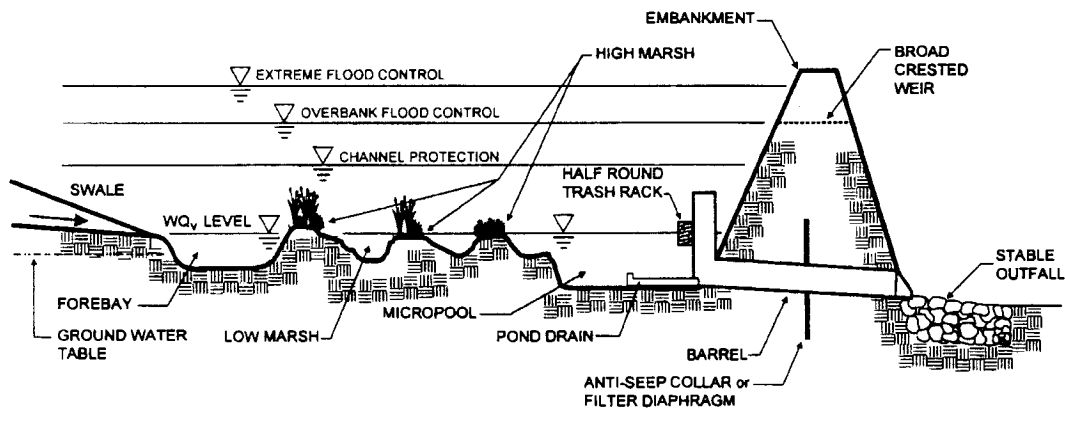

PROFILE

### 6.2.1 Feasibility

#### Design Guidance

- *Stormwater wetlands should not be located within existing jurisdictional wetlands.* In some isolated cases, a permit may be granted to convert an existing degraded wetland in the context of local watershed restoration efforts.
- The use of stormwater wetlands on trout waters is strongly discouraged, as available evidence suggests that these practices can increase stream temperatures.

### 6.2.2 Conveyance

#### Required Elements

- Flowpaths from the inflow points to the outflow points of stormwater wetlands shall be maximized.
- A minimum flowpath of 2:1 (length to relative width) shall be provided across the stormwater wetland. This path may be achieved by constructing internal berms (e.g., high marsh wedges or rock filter cells).

#### Design Guidance

- Microtopography is encouraged to enhance wetland diversity.

### 6.2.3 Pretreatment

#### Required Elements

- A forebay shall be located at the inlet, and a four to six foot deep micropool that stores approximately 10% of the  $WQ_v$  shall be located at the outlet to protect the low flow pipe from clogging and prevent sediment resuspension.

### 6.2.4 Treatment

#### Required Elements

- The surface area of the entire stormwater wetland shall be at least one percent of the contributing drainage area (1.5% for shallow marsh design).
- At least 25% of the  $WQ_v$  shall be in deepwater zones with a depth greater than four feet.

- A minimum of 35% of the total surface of area can have a depth of six inches or less, and at least 65% of the total surface area shall be shallower than 18 inches.
- If extended detention is used in a stormwater wetland, provide a minimum of 50% of the  $WQ_v$  in permanent pool; the maximum water surface elevation of  $WQ_v$ -ED shall not extend more than three feet above the permanent pool.

#### Design Guidance

- The bed of stormwater wetlands should be graded to create maximum internal flow path and microtopography.
- To promote greater nitrogen removal, rock beds may be used a medium for growth of wetland plants. The rock should be one to three inches in diameter, placed up to the normal pool elevation, and open to flow-through from either direction.

#### 6.2.5 *Landscaping*

##### Required Elements

- A landscaping plan shall be provided that indicates the methods used to establish and maintain wetland coverage. Minimum elements of a plan include: delineation of pondscaping zones, selection of corresponding plant species, planting plan, sequence for preparing wetland bed (including soil amendments, if needed) and sources of plant material.
- A wetland plant buffer must extend 25 feet outward from the maximum water surface elevation, with an additional 15-foot setback to structures.
- Donor soils for wetland mulch shall not be removed from natural wetlands.

##### Design Guidance

- Structures such as fascines, coconut rolls, straw bales, or carefully designed stone weirs can be used to create shallow marsh cells in high-energy areas of the stormwater wetland.
- The landscaping plan should provide elements that promote greater wildlife and waterfowl use within the wetland and buffers.
- Follow wetland establishment guidelines (see Appendix H).



### 6.2.6 *Maintenance*

#### Required Elements

- If a minimum coverage of 50% is not achieved in the planted wetland zones after the second growing season, a reinforcement planting is required.

#### Design Guidance

- Stormwater wetlands that are separated from jurisdictional wetlands and regularly maintained are not typically regulated under State and Federal laws.

### 6.2.7 *Cold Climate Design Considerations*

Many of the cold climate concerns for wetlands are very similar to the ones for ponds. Two additional concerns with regards to stormwater wetlands focus on cold climate impacts to wetland plants:

- Short Growing Season
- Chlorides

#### Short Growing Season

- Planting schedule should reflect the short growing season, perhaps incorporating relatively mature plants, or planting rhizomes during the winter.

#### Chlorides

- Use in combination with a grassed infiltration area prior to the wetland to provide some infiltration of chlorides to dampen the shock to wetland plants
- Emphasize the pond/wetland design option to dilute chlorides prior to the wetland area. If this option is used, the pond should use the modifications described in Section 6.1.7. The pond system dilutes chlorides before they enter the marsh, protecting wetland plants.
- Consider salt-tolerant plants if wetland treats runoff from roads or parking lots where salt is used as a deicer.

### Stormwater Wetlands



**Description:** Stormwater wetlands (a.k.a. constructed wetlands) are structural practices that incorporate wetland plants into the design to both store and treat runoff. As stormwater runoff flows through the wetland, pollutant removal is achieved through settling and biological uptake within the practice

**Design Options:**  
 Shallow wetland (W-1), Extended Detention Wetland (W-2), Pond/Wetland (W-3), Pocket Wetland (W-4)

<u>KEY CONSIDERATIONS</u>	<u>STORMWATER MANAGEMENT SUITABILITY</u>								
<p>MUST MEET ALL OF THE REQUIREMENTS OF STORMWATER PONDS.</p> <p><b>CONVEYANCE</b></p> <ul style="list-style-type: none"> <li>• Minimum flowpath of 2:1 (length to width)</li> <li>• Flowpath maximized</li> </ul> <p><b>PRETREATMENT</b></p> <ul style="list-style-type: none"> <li>• Micropool at outlet, capturing 10% of the WQ<sub>v</sub></li> </ul> <p><b>TREATMENT</b></p> <ul style="list-style-type: none"> <li>• Minimum drainage area to surface ratio of 1:100</li> <li>• ED no greater than 50% of entire WQ<sub>v</sub> (permanent pool at least 50% of the volume) 25% of the WQ<sub>v</sub> in deepwater zones.</li> <li>• 35% of the total surface area in depths six inches or less, and 65% shallower than 18"</li> </ul> <p><b>LANDSCAPING</b></p> <ul style="list-style-type: none"> <li>• Landscaping plan that indicates methods to establish and maintain wetland coverage. Minimum elements include: delineation of pondscaping zones, selection of species, planting plan, and sequence for bed preparation.</li> <li>• Wetland buffer 25 feet from maximum surface elevation, with 15 foot additional setback for structures.</li> <li>• Donor plant material must not be from natural wetlands</li> </ul> <p><b>MAINTENANCE REQUIREMENTS</b></p> <ul style="list-style-type: none"> <li>• Reinforcement plantings after second season if 50% coverage not achieved</li> </ul> <p style="text-align: center;"><b><u>POLLUTANT REMOVAL</u></b></p> <table border="0"> <tr> <td style="border: 1px solid black; text-align: center; width: 20px;"><b>G</b></td> <td><b>Phosphorus</b></td> </tr> <tr> <td style="border: 1px solid black; text-align: center;"><b>G</b></td> <td><b>Nitrogen</b></td> </tr> <tr> <td style="border: 1px solid black; text-align: center;"><b>F</b></td> <td><b>Metals - Cadmium, Copper, Lead, and Zinc removal</b></td> </tr> <tr> <td style="border: 1px solid black; text-align: center;"><b>G</b></td> <td><b>Pathogens - Coliform, Streptococci, E.Coli removal</b></td> </tr> </table> <p style="border: 1px solid black; padding: 2px;">Key: G=Good F=Fair P=Poor</p>	<b>G</b>	<b>Phosphorus</b>	<b>G</b>	<b>Nitrogen</b>	<b>F</b>	<b>Metals - Cadmium, Copper, Lead, and Zinc removal</b>	<b>G</b>	<b>Pathogens - Coliform, Streptococci, E.Coli removal</b>	<p><input checked="" type="checkbox"/> <b>Water Quality</b></p> <p><input checked="" type="checkbox"/> <b>Channel Protection</b></p> <p><input checked="" type="checkbox"/> <b>Overbank Flood Protection</b></p> <p><input checked="" type="checkbox"/> <b>Extreme Flood Protection</b></p> <p><b>Accepts Hotspot Runoff: Yes</b>  <i>(2 feet minimum separation distance required to water table)</i></p> <p style="text-align: center;"><b><u>IMPLEMENTATION CONSIDERATIONS</u></b></p> <p><input style="width: 20px; height: 20px; text-align: center; vertical-align: middle;" type="checkbox"/> <b>Capital Cost</b></p> <p style="padding-left: 40px;"><b>Maintenance Burden:</b></p> <p><input style="width: 20px; height: 20px; text-align: center; vertical-align: middle;" type="checkbox"/> Shallow Wetland</p> <p><input style="width: 20px; height: 20px; text-align: center; vertical-align: middle;" type="checkbox"/> ED Shallow Wetland</p> <p><input style="width: 20px; height: 20px; text-align: center; vertical-align: middle;" type="checkbox"/> Pocket Wetland</p> <p><input style="width: 20px; height: 20px; text-align: center; vertical-align: middle;" type="checkbox"/> Pond/Wetland</p> <p><b><u>Residential Subdivision Use: Yes</u></b>  <b><u>High-Density/Ultra-Urban: No</u></b></p> <p><b>Soils: Hydrologic group 'A' and 'B' soils may require liner</b></p> <p style="text-align: center;">Key : L=Low M=Moderate H=High</p>
<b>G</b>	<b>Phosphorus</b>								
<b>G</b>	<b>Nitrogen</b>								
<b>F</b>	<b>Metals - Cadmium, Copper, Lead, and Zinc removal</b>								
<b>G</b>	<b>Pathogens - Coliform, Streptococci, E.Coli removal</b>								

**Section 6.3 Stormwater Infiltration**

Stormwater infiltration practices capture and temporarily store the  $WQ_v$  before allowing it to infiltrate into the soil over a two-day period. Design variants include the following:

- I-1 Infiltration Trench (Figure 6.11)
- I-2 Infiltration Basin (Figure 6.12)
- I-3 Dry Well (Figure 6.13)

**Treatment Suitability:** Infiltration practices alone typically cannot meet detention ( $Q_p$ ) and channel protection ( $Cp_v$ ) requirements, except on sites where the soil infiltration rate is greater than 5.0 in/hr. However, extended detention storage may be provided above an infiltration basin. Extraordinary care should be taken to assure that long-term infiltration rates are achieved through the use of performance bonds, post construction inspection and long-term maintenance.

Figure 6.11 Infiltration Trench (I-1)

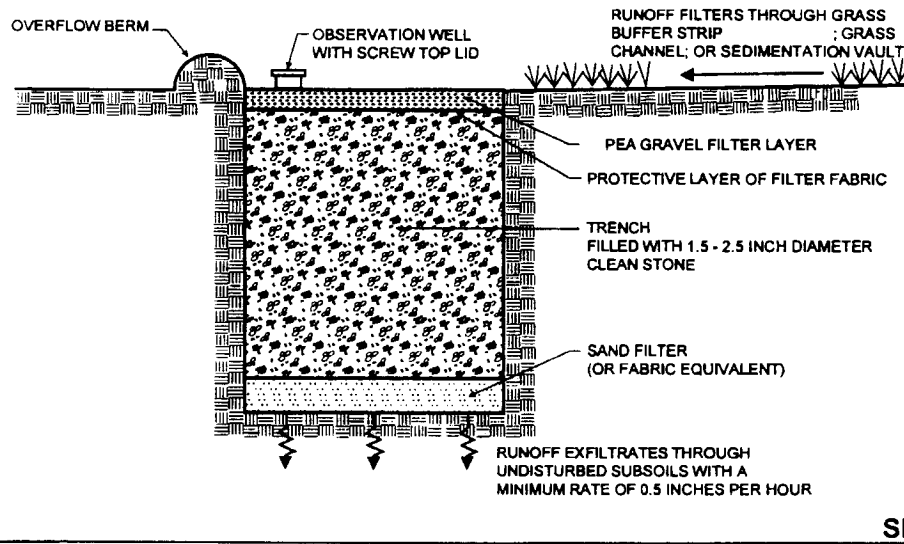
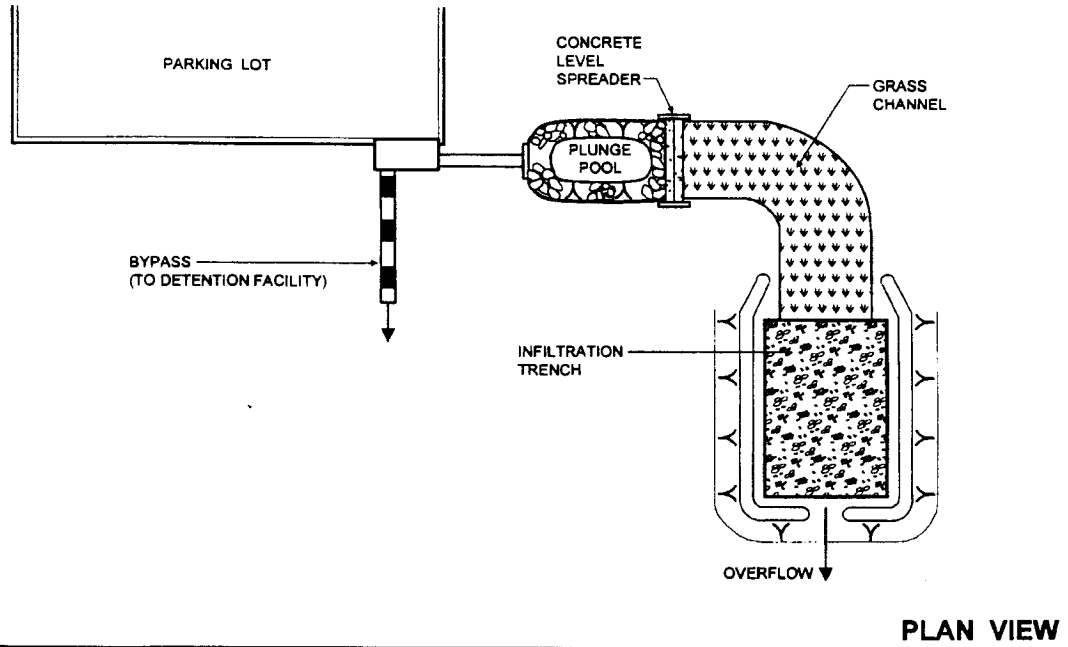

Figure 6.12 Infiltration Basin (I-2)

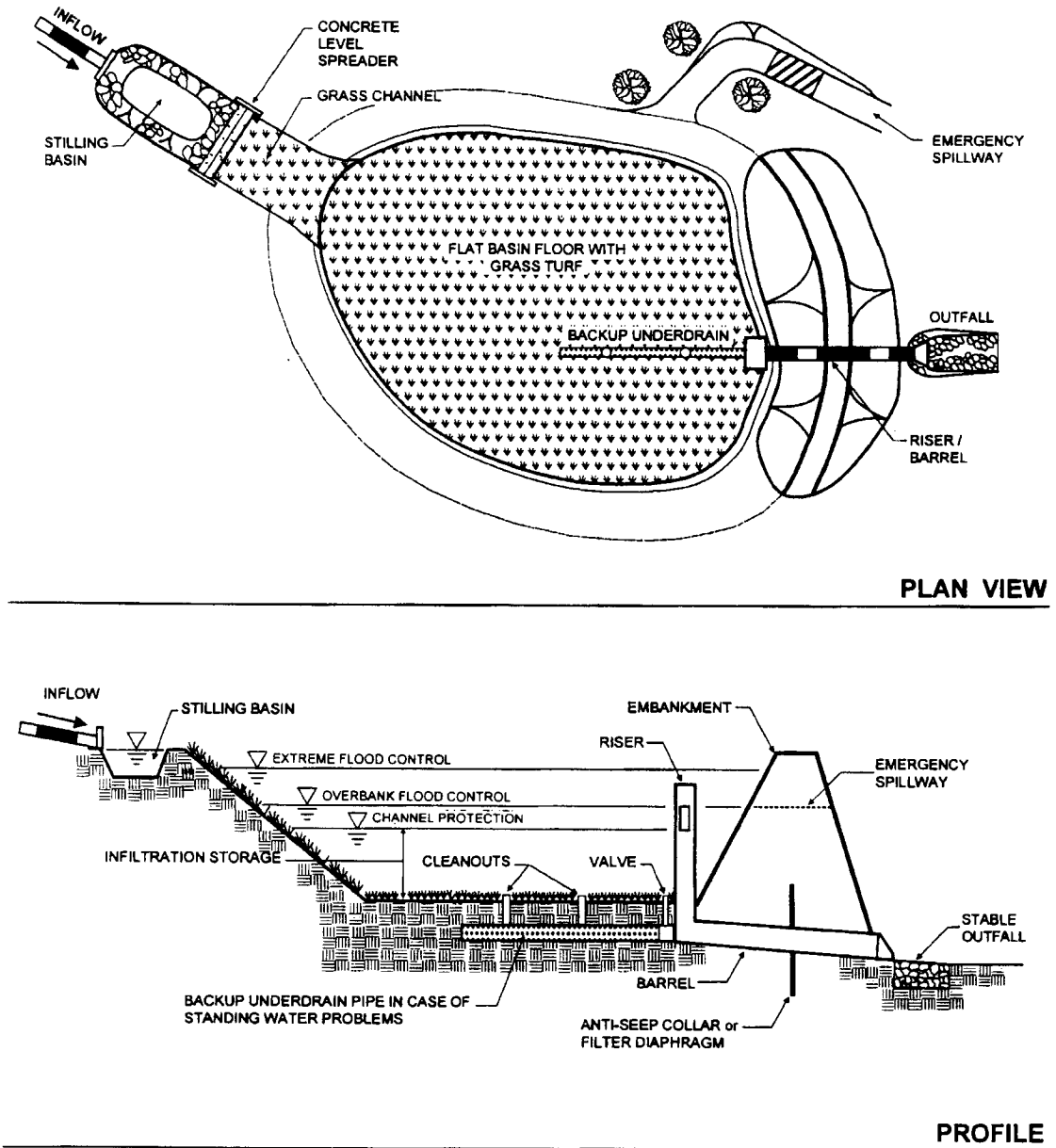
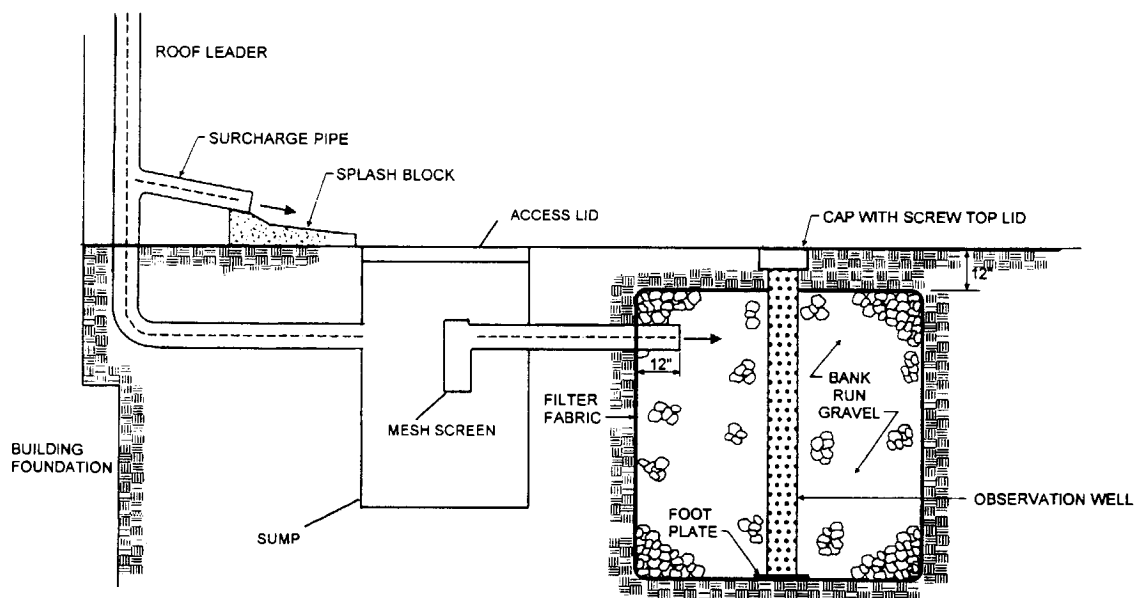

Figure 6.13 Dry Well (I-3)



### 6.3.1 Feasibility

#### Required Elements

- To be suitable for infiltration, underlying soils shall have an infiltration rate (fc) of at least 0.5 inches per hour, as initially determined from NRCS soil textural classification, and subsequently confirmed by field geotechnical tests (see Appendix D). The minimum geotechnical testing is one test hole per 5000 sf, with a minimum of two borings per facility (taken within the proposed limits of the facility).
- Soils shall also have a clay content of less than 20% and a silt/clay content of less than 40%.
- Infiltration practices cannot be located on areas with natural slopes greater than 15%.
- Infiltration practices cannot be located in fill soils, except the top quarter of an infiltration trench or dry well.
- To protect groundwater from possible contamination, runoff from designated hotspot land uses or activities must not be directed to a formal infiltration facility. In cases where this goal is impossible (e.g., where the storm drain system leads to a large recharge facility designed for flood control), redundant pretreatment must be provided by applying two of the practices listed in Table 5.1 in series, both of which are sized to treat the entire  $WQ_v$ .
- The bottom of the infiltration facility shall be separated by at least three feet vertically from the seasonally high water table or bedrock layer, as documented by on-site soil testing. (Four feet in sole source aquifers).
- Infiltration facilities shall be located at least 100 feet horizontally from any water supply well.
- Infiltration practices cannot be placed in locations that cause water problems to downgradient properties. Infiltration trenches and basins shall be setback 25 feet downgradient from structures and septic systems. Dry wells shall be separated a minimum of 10 feet from structures.

#### Design Guidance

- The maximum contributing area to infiltration basins or trenches should generally be less than five acres. The infiltration basin can theoretically receive runoff from larger areas, provided that the soil is highly permeable (i.e., greater than 5.0 inches per hour). (See Appendix L for erosive velocities of grass and soil).
- The maximum drainage area to dry wells should generally be smaller than one acre, and should include rooftop runoff only.

### 6.3.2 *Conveyance*

#### Required Elements

- The overland flow path of surface runoff exceeding the capacity of the infiltration system shall be evaluated to preclude erosive concentrated flow during the overbank events. If computed flow velocities exceed erosive velocities (3.5 to 5.0 fps), an overflow channel shall be provided to a stabilized watercourse. (See Appendix L for erosive velocities of grass and soil).
- All infiltration systems shall be designed to fully de-water the entire  $WQ_v$  within 48 hours after the storm event.
- If runoff is delivered by a storm drain pipe or along the main conveyance system, the infiltration practice must be designed as an off-line practice (see Appendix K for a detail), except when used as a regional flood control practice.

#### Design Guidance

- For infiltration basins and trenches, adequate stormwater outfalls should be provided for the overflow associated with the 10-year design storm event (non-erosive velocities on the down-slope)
- For dry wells, all flows that exceed the capacity of the dry well should be passed through the surcharge pipe.

### 6.3.3 *Pretreatment*

#### Required Elements

- A minimum pretreatment volume of 25% of the  $WQ_v$  must be provided prior to entry to an infiltration facility, and can be provided in the form of a sedimentation basin, sump pit, grass channel, plunge pool or other measure.
- If the  $f_c$  for the underlying soils is greater than 2.00 inches per hour, a minimum pretreatment volume of 50% of the  $WQ_v$  must be provided.
- If the  $f_c$  for the underlying soils is greater than 5.00 inches per hour, 100% of the  $WQ_v$  shall be pre-treated prior to entry into an infiltration facility.
- Exit velocities from pretreatment chambers shall be non-erosive (3.5 to 5.0 fps) during the two-year design storm). (See Appendix L for erosive velocities of grass and soil).



### **Pretreatment Techniques to Prevent Clogging**

Infiltration basins or trenches can have redundant methods to ensure the long-term integrity of the infiltration rate. The following techniques are pretreatment options for infiltration practices:

- Grass channel (Maximum velocity of 1 fps for water quality flow. See the Fact Sheet on page 5-10 for more detailed design information.)
- Grass filter strip (minimum 20 feet and only if sheet flow is established and maintained)
- Bottom sand layer (for I-1)
- Upper sand layer (for I-1; 6" minimum with filter fabric at sand/gravel interface)
- Use of washed bank run gravel as aggregate
- Alternatively, a pre-treatment settling chamber may be provided and sized to capture the pretreatment volume. Use the method prescribed in section 6.4.3 (i.e., the Camp-Hazen equation) to size the chamber.
- Plunge Pool
- An underground trap with a permanent pool between the downspout and the dry well (I-3)

#### Design Guidance

- The sides of infiltration trenches and dry wells should be lined with an acceptable filter fabric that prevents soil piping.
- In infiltration trench designs, incorporate a fine gravel or sand layer above the coarse gravel treatment reservoir to serve as a filter layer.

#### *6.3.4 Treatment*

#### Required Elements

- Infiltration practices shall be designed to exfiltrate the entire WQ<sub>v</sub> through the floor of each practice (sides are not considered in sizing).
- The construction sequence and specifications for each infiltration practice shall be precisely followed. Experience has shown that the longevity of infiltration practices is strongly influenced by the care taken during construction
- Calculate the surface area of infiltration trenches as:

$$A_p = V_w / (nd_t)$$

Where:

- $A_p$  = surface area (sf)
- $V_w$  = design volume (e.g.,  $WQ_v$ ) ( $ft^3$ )
- $n$  = porosity (assume 0.4)
- $d_t$  = trench depth (maximum of four feet, and separated at least three feet from seasonally high groundwater) (ft)

- Calculate the approximate bottom area of infiltration basins using the following equation:

$$A = V_w/d_b$$

Where:

- $A$  = surface area of the basin ( $ft^2$ )
- $d_b$  = depth of the basin (ft)

Note that in trapezoidal basins, this area should first be used to approximate the area at the bottom of the basin, but can later be modified to account for additional storage provided above side slopes.

#### Design Guidance

- Infiltration practices are best used in conjunction with other practices, and downstream detention is often needed to meet the  $C_p$  and  $Q_p$  sizing criteria.
- A porosity value ( $V_v/V_t$ ) of 0.4 can be used to design stone reservoirs for infiltration practices.

The bottom of the stone reservoir should be completely flat so that infiltrated runoff will be able to infiltrate through the entire surface.

#### 6.3.5 *Landscaping*

##### Required Elements

- Upstream construction shall be completed and stabilized before connection to a downstream infiltration facility. A dense and vigorous vegetative cover shall be established over the contributing pervious drainage areas before runoff can be accepted into the facility.
- Infiltration trenches shall not be constructed until all of the contributing drainage area has been completely stabilized.

##### Design Guidance

- Mow upland and adjacent areas, and seed bare areas.

### 6.3.6 Maintenance

#### Required Elements

- Infiltration practices shall never serve as a sediment control device during site construction phase. In addition, the Erosion and Sediment Control plan for the site shall clearly indicate how sediment will be prevented from entering an infiltration facility. Normally, the use of diversion berms around the perimeter of the infiltration practice, along with immediate vegetative stabilization and/or mulching can achieve this goal.
- An observation well shall be installed in every infiltration trench and dry well, consisting of an anchored six- inch diameter perforated PVC pipe with a lockable cap installed flush with the ground surface.
- Direct access shall be provided to infiltration practices for maintenance and rehabilitation. If a stone reservoir or perforated pipe is used to temporarily store runoff prior to infiltration, the practice shall not be covered by an impermeable surface.

#### Design Guidance

- OSHA trench safety standards should be consulted if the infiltration trench will be excavated more than five feet.
- Infiltration designs should include dewatering methods in the event of failure. Dewatering can be accomplished with underdrain pipe systems that accommodate drawdown.

### 6.3.7 Cold Climate Design Considerations

Because of additional challenges in cold climates, infiltration SMPs need design modifications to function properly. These modifications address the following problems:

- Reduced infiltration into frozen soils
- Chlorides

### Reduced Infiltration

- Draining the ground beneath an infiltration system with an underdrain can increase cold weather soil infiltration.
- Another alternative is to divide the treatment volume between an infiltration SMP and another SMP to provide some treatment during the winter months.
- A seasonally operated infiltration/detention facility combines several techniques to improve the performance of infiltration SMPs in cold climates. Two features, the underdrain system and level control valves, are useful in cold climates. The level control and valves are opened at the beginning of the winter season and the soil is allowed to drain. As the snow begins to melt in the spring, the valves are closed, and the snowmelt is infiltrated until the capacity of the soil is reached. After this point, the facility acts as a detention facility, providing storage for particles to settle (Figure 6.14)

### Chlorides

- Consider diverting snowmelt runoff past infiltration devices, especially in regions where chloride concentration in groundwater is a concern.
- Incorporate mulch into infiltration basin soil to mitigate problems with soil fertility.
- The selection of upland landscaping materials should include salt-tolerant grasses where appropriate.

Figure 6.14 Seasonal Operation Infiltration Facility

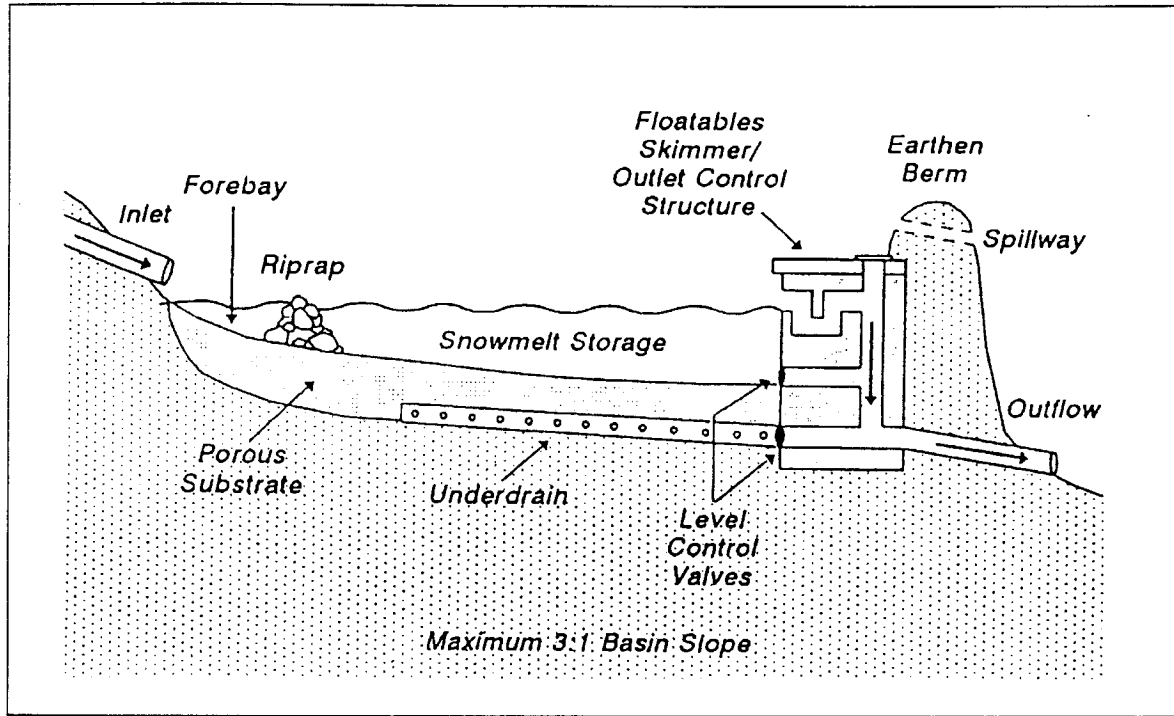

## Infiltration Practices

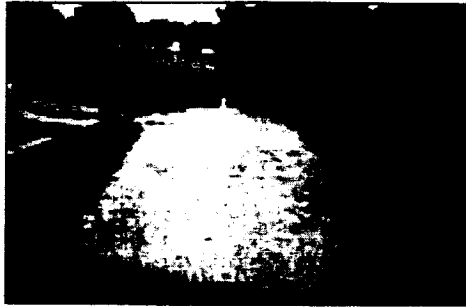

**Description:** Excavated trench or basin used to capture and allow infiltration of stormwater runoff into the surrounding soils from the bottom and sides of the basin or trench.

**Design Options:**  
Infiltration Trench (I-1), Shallow Infiltration Basin (I-2), Dry Well (I-3)

<u>KEY CONSIDERATIONS</u>	<u>STORMWATER MANAGEMENT SUITABILITY</u>
<p><b>FEASIBILITY</b></p> <ul style="list-style-type: none"> <li>• Minimum soil infiltration rate of 0.5 inches per hour</li> <li>• Soils less than 20% clay, and 40% silt/clay, and no fill soils.</li> <li>• Natural slope less than 15%</li> <li>• Cannot accept hotspot runoff, except under the conditions outlined in Section 6.3.1.</li> <li>• Separation from groundwater table of at least three feet (four feet in sole source aquifers).</li> <li>• 25' separation from structures for I-1 and I-2; 10' for I-3.</li> </ul> <p><b>CONVEYANCE</b></p> <ul style="list-style-type: none"> <li>• Flows exiting the practice must be non-erosive (3.5 to 5.0 fps)</li> <li>• Maximum dewatering time of 48 hours.</li> <li>• Design off-line if stormwater is conveyed to the practice by a storm drain pipe.</li> </ul> <p><b>PRETREATMENT</b></p> <ul style="list-style-type: none"> <li>• Pretreatment of 25% of the WQv at all sites.</li> <li>• 50% pretreatment if <math>f_c &gt; 2.0</math> inches/hour.</li> <li>• 100% pretreatment in areas with <math>f_c &gt; 5.0</math> inches/hour.</li> <li>• Exit velocities from pretreatment must be non-erosive for the 2-year storm.</li> </ul> <p><b>TREATMENT</b></p> <ul style="list-style-type: none"> <li>• Water quality volume designed to exfiltrate through the floor of the practice.</li> <li>• Construction sequence to maximize practice life.</li> <li>• Trench depth shall be less than four feet (I-2 and I-3).</li> <li>• Follow the methodologies in Chapter 6 to size practices.</li> </ul> <p><b>LANDSCAPING</b></p> <ul style="list-style-type: none"> <li>• Upstream area shall be completely stabilized before flow is directed to the practice.</li> </ul> <p><b>MAINTENANCE REQUIREMENTS</b></p> <ul style="list-style-type: none"> <li>• Never serves as a sediment control device</li> <li>• Observation well shall be installed in every trench, (6" PVC pipe, with a lockable cap)</li> <li>• Provide direct maintenance access.</li> </ul>	<p><input checked="" type="checkbox"/> <b>Water Quality</b></p> <p><input type="checkbox"/> <b>Channel Protection</b></p> <p><input type="checkbox"/> <b>Overbank Flood Protection</b></p> <p><input type="checkbox"/> <b>Extreme Flood Protection</b></p> <p><b>Accepts Hotspot Runoff: No</b></p> <hr/> <p style="text-align: center;"><b><u>IMPLEMENTATION CONSIDERATIONS</u></b></p> <p><input type="checkbox"/> <b>Capital Cost</b></p> <p><input type="checkbox"/> <b>Maintenance Burden</b></p> <p><b><u>Residential Subdivision Use:</u> Yes</b></p> <p><b>High Density/Ultra-Urban: Yes</b></p> <p><b>Drainage Area: 10 acres max.</b></p> <p><b>Soils: Pervious soils required (0.5 in/hr or greater)</b></p> <p><b>Other Considerations:</b></p> <ul style="list-style-type: none"> <li>• <i>Must not be placed under pavement or concrete</i></li> </ul> <p style="border: 1px solid black; padding: 2px;">Key: L=Low M=Moderate H=High</p>

<b><u>POLLUTANT REMOVAL</u></b>	
<b>G</b>	<b>Phosphorus</b>
<b>G</b>	<b>Nitrogen</b>
<b>G</b>	<b>Metals - Cadmium, Copper, Lead, and Zinc removal</b>
<b>G</b>	<b>Pathogens - Coliform, Streptococci, E.Coli removal</b>
<b>Key: G=Good F=Fair P=Poor</b>	

**Section 6.4 Stormwater Filtering Systems**

Stormwater filtering systems capture and temporarily store the  $WQ_v$  and pass it through a filter bed of sand, organic matter, or soil. Filtered runoff may be collected and returned to the conveyance system, or allowed to partially exfiltrate into the soil. Design variants include:

F-1	Surface Sand Filter	(Figure 6.15)
F-2	Underground Sand Filter	(Figure 6.16)
F-3	Perimeter Sand Filter	(Figure 6.17)
F-4	Organic Filter	(Figure 6.18)
F-5	Bioretention	(Figure 6.19)

Treatment Suitability: Filtering systems should not be designed to provide stormwater detention ( $Q_p$ ) or channel protection ( $C_p$ ) except under extremely unusual conditions. Filtering practices shall generally be combined with a separate facility to provide those controls.



Figure 6.15 Surface Sand Filter (F-1)

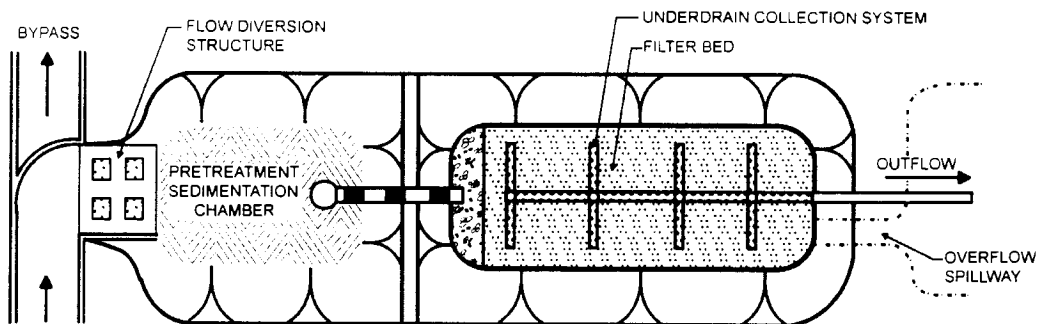

**PLAN VIEW**

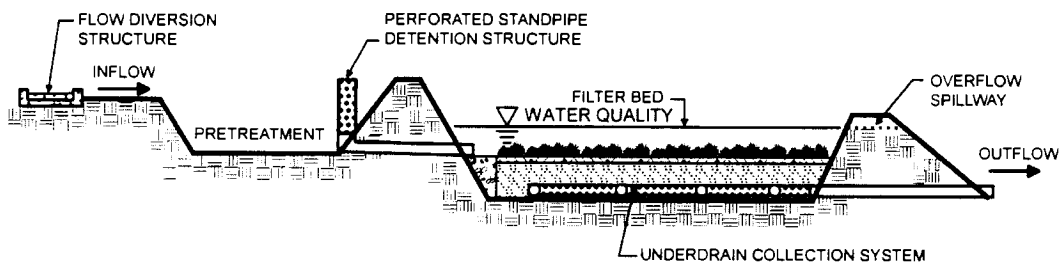

**PROFILE**

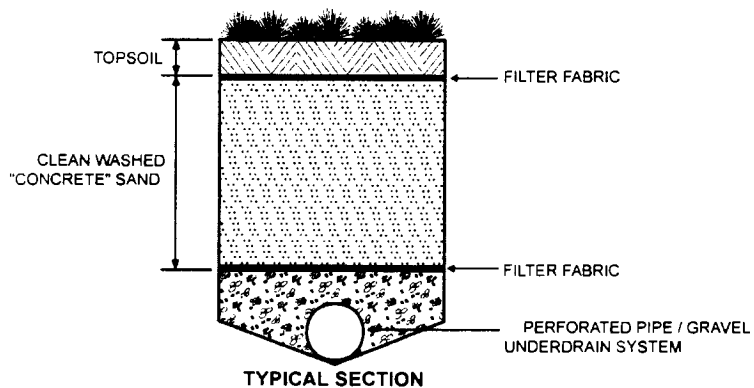

Figure 6.16 Underground Sand Filter (F-2)

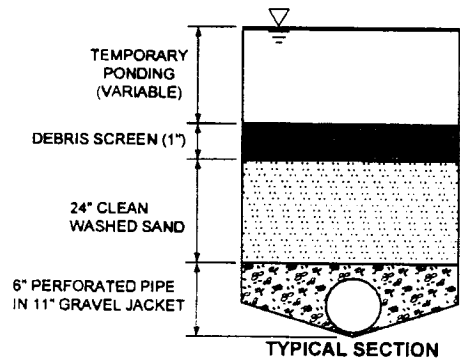
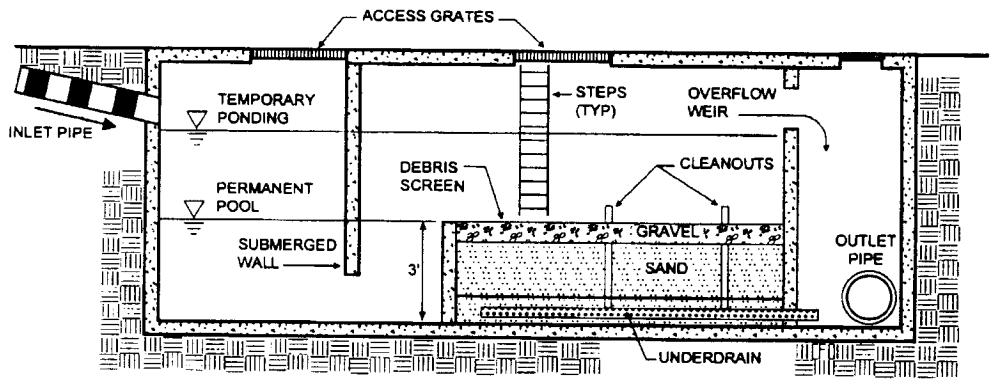
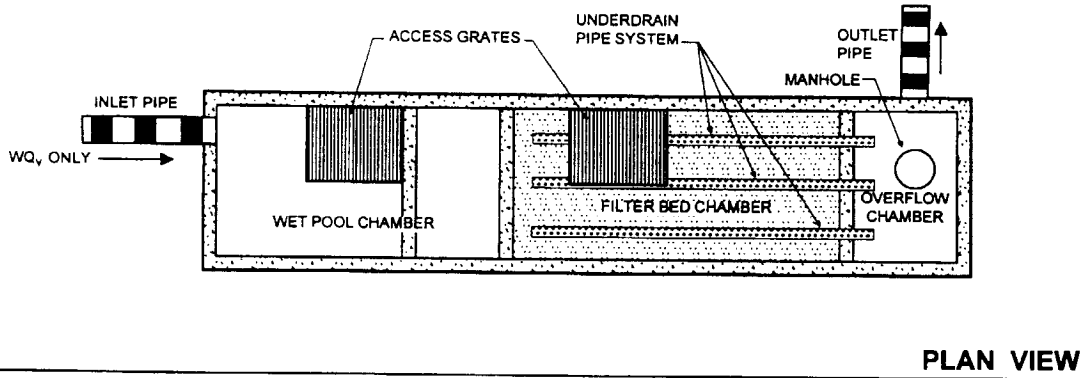

Figure 6.17 Perimeter Sand Filter (F-3)

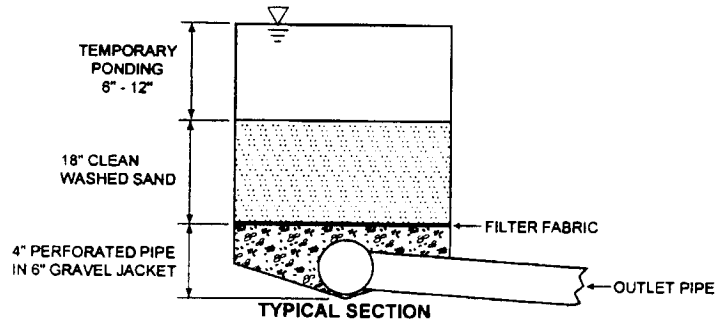
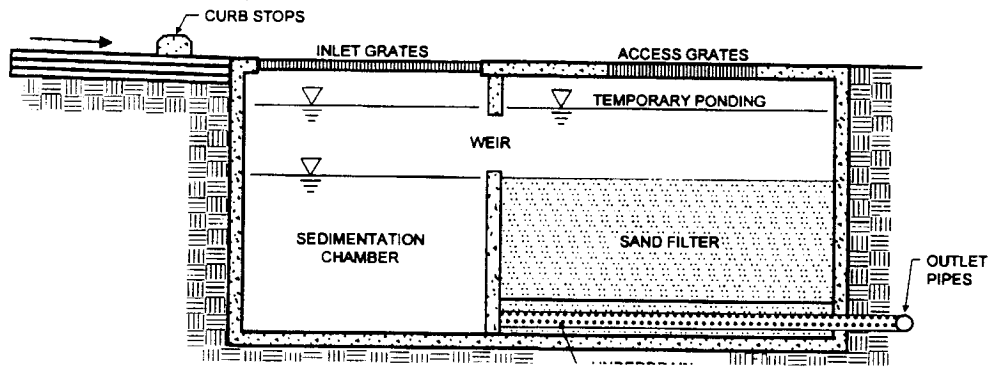
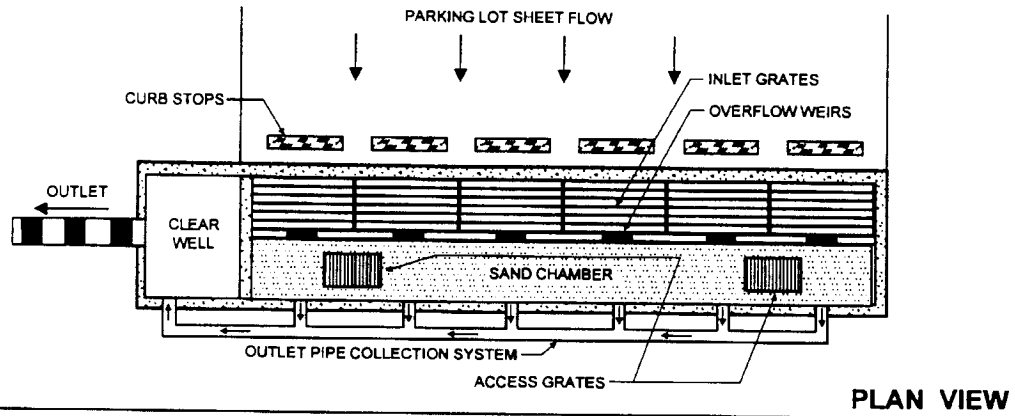

Figure 6.18 Organic Filter (F- 4)

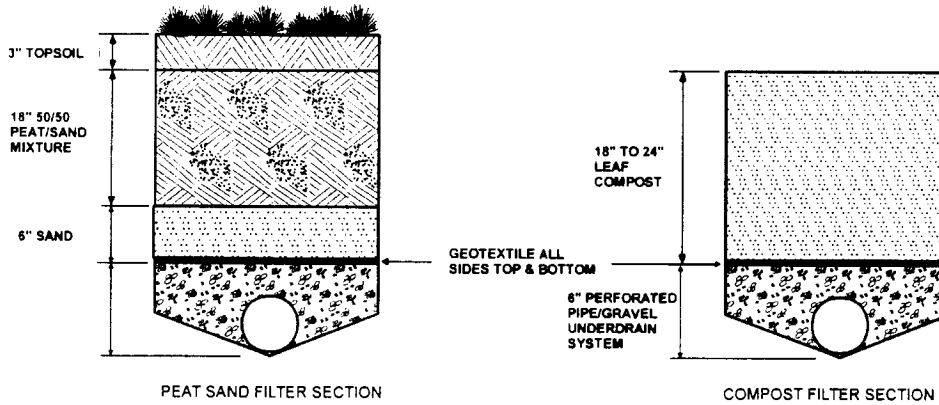
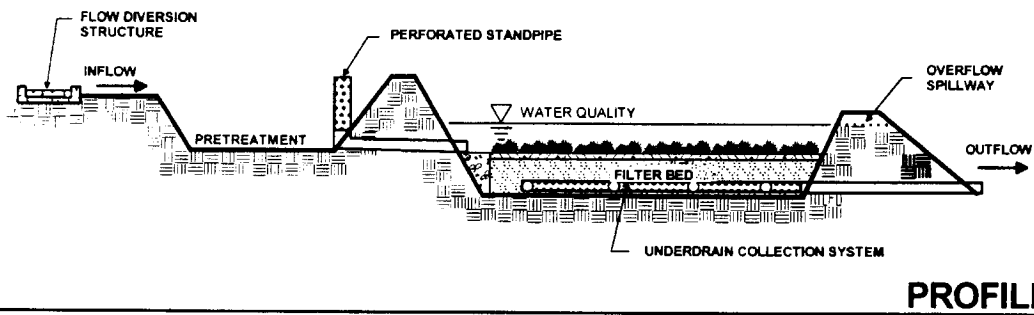
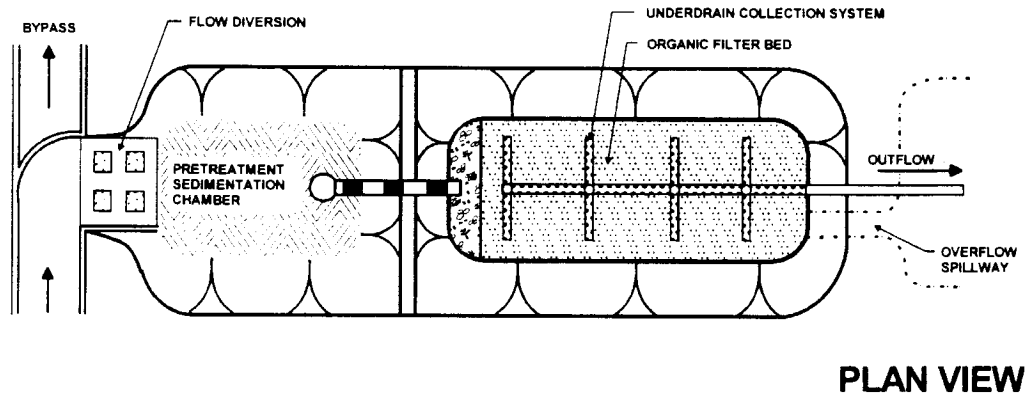
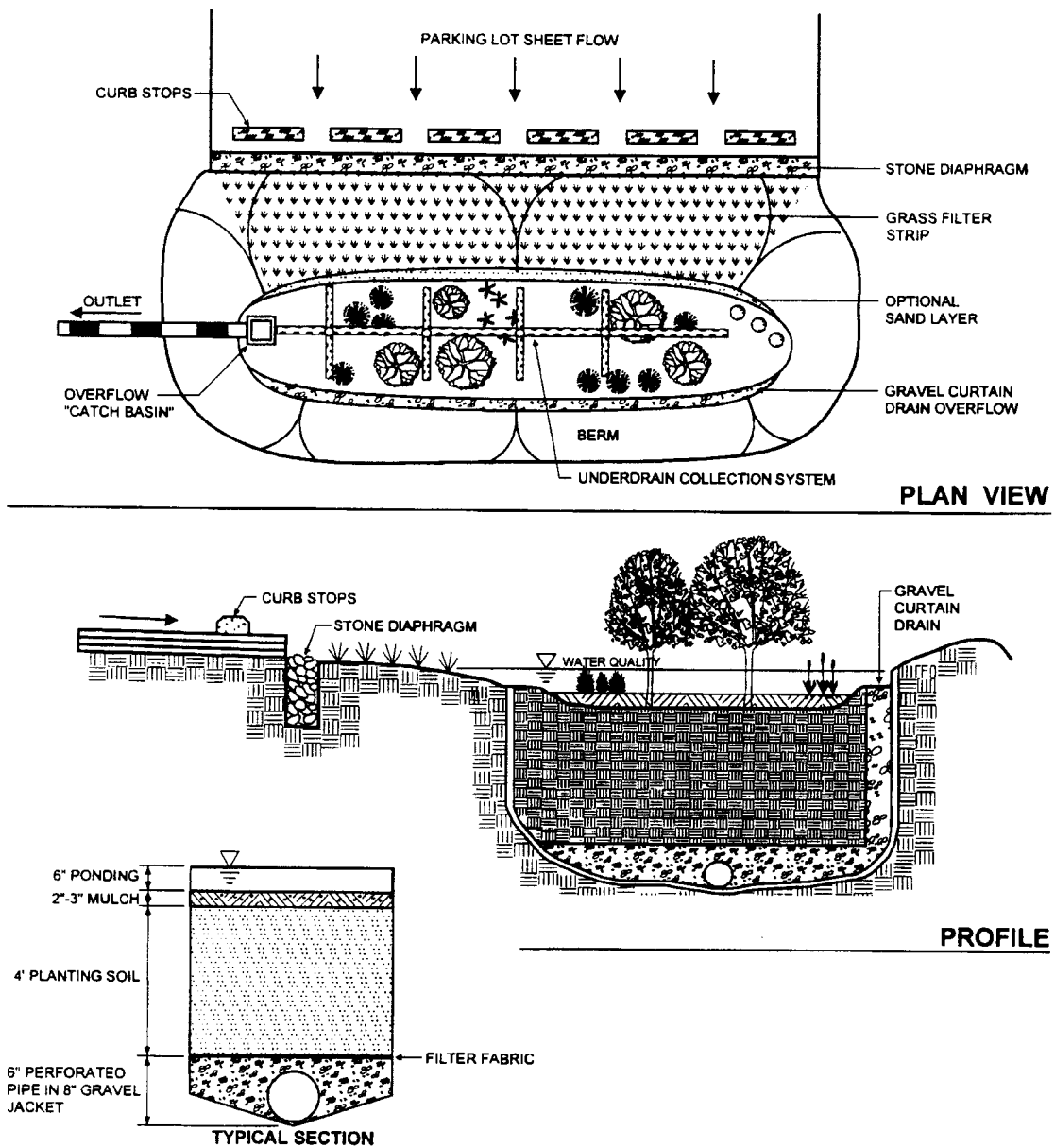

Figure 6.19 Bioretention (F-5)



### 6.4.1 Feasibility

#### Design Guidance

- Most stormwater filters require four to six feet of head, depending on site configuration and land area available. The perimeter sand filter (F-3), however, can be designed to function with as little as 18" to 24" of head.
- The recommended maximum contributing area to an individual stormwater filtering system is usually less than 10 acres. In some situations, larger areas may be acceptable.
- Sand and organic filtering systems are generally applied to land uses with a high percentage of impervious surfaces. Sites with imperviousness less than 75% will require full sedimentation pretreatment techniques.

### 6.4.2 Conveyance

#### Required Elements

- If runoff is delivered by a storm drain pipe or is along the main conveyance system, the filtering practice shall be designed off-line (see Appendix K).
- An overflow shall be provided within the practice to pass a percentage of the  $WQ_v$  to a stabilized water course. In addition, overflow for the ten-year storm shall be provided to a non-erosive outlet point (i.e., prevent downstream slope erosion).
- A flow regulator (or flow splitter diversion structure) shall be supplied to divert the  $WQ_v$  to the filtering practice, and allow larger flows to bypass the practice.
- Stormwater filters shall be equipped with a minimum 4" perforated pipe underdrain (6" is preferred) in a gravel layer. A permeable filter fabric shall be placed between the gravel layer and the filter media.
- Require a minimum 2' separation between the filter bottom and groundwater.

### 6.4.3 Pretreatment

#### Required Elements

- Dry or wet pretreatment shall be provided prior to filter media equivalent to at least 25% of the computed  $WQ_v$ . The typical method is a sedimentation basin that has a length to width ratio of 1.5:1. The Camp-Hazen equation is used to compute the required surface area for sand and organic filters requiring full sedimentation for pretreatment (WSDE, 1992) as follows:

- The required sedimentation basin area is computed using the following equation:

$$A_s = -(Q_o/W) \cdot \ln(1-E)$$

where:

- $A_s$  = Sedimentation basin surface area (ft<sup>2</sup>)
- $E$  = sediment trap efficiency (use 90%)
- $W$  = particle settling velocity (ft/sec)
  - use 0.0004 ft/sec for imperviousness (I) ≤ 75%
  - use 0.0033 ft/sec for I > 75%
- $Q_o$  = Discharge rate from basin = (WQ<sub>v</sub>/24 hr)

This equation reduces to:

$$A_s = (0.066) (WQ_v) \text{ ft}^2 \text{ for } I \leq 75\%$$

$$A_s = (0.0081) (WQ_v) \text{ ft}^2 \text{ for } I > 75\%$$

Design Guidance

- Adequate pretreatment for bioretention systems should incorporate all of the following: (a) grass filter strip below a level spreader or grass channel, (b) gravel diaphragm and (c) a mulch layer.
- The grass filter strip should be sized using the guidelines in Table 6.2.

Table 6.2 Guidelines for Filter Strip Pretreatment Sizing								
Parameter	Impervious Parking Lots				Residential Lawns			
	Maximum Inflow Approach Length (ft.)	35		75		75		150
Filter Strip Slope	≤2%	≥2%	≤2%	≥2%	≤2%	≥2%	≤2%	≥2%
Filter Strip Minimum Length	10'	15'	20'	25'	10'	12'	15'	18'

- The grass channel should be sized using the following procedure:
  - 1- Determine the channel length needed to treat the WQ<sub>v</sub>, using sizing techniques described in the Grass Channel Fact Sheet (Chapter 5).
  - 2- Determine the volume directed to the channel for pretreatment
  - 3- Determine the channel length by multiplying the length determined in step 1 above by the ratio of the volume in step 2 to the WQ<sub>v</sub>.

#### 6.4.4 Treatment

##### Required Elements

- The entire treatment system (including pretreatment) shall be sized to temporarily hold at least 75% of the  $WQ_v$  prior to filtration.
- The filter media shall consist of a medium sand (meeting ASTM C-33 concrete sand). Media used for organic filters may consist of peat/sand mix or leaf compost. Peat shall be a reed-sedge hemic peat.
- Bioretention systems shall consist of the following treatment components: A four foot deep planting soil bed, a surface mulch layer, and a six inch deep surface ponding area. Soils shall meet the design criteria outlined in Appendix H.

##### Design Guidance

- The filter bed typically has a minimum depth of 18". The perimeter filter may have a minimum filter bed depth of 12".
- The filter area for sand and organic filters should be sized based on the principles of Darcy's Law. A coefficient of permeability (k) should be used as follows:

Sand:	3.5 ft/day (City of Austin 1988)
Peat:	2.0 ft/day (Galli 1990)
Leaf compost:	8.7 ft/day (Claytor and Schueler, 1996)
Bioretention Soil:	0.5 ft/day (Claytor and Schueler, 1996)

The required filter bed area is computed using the following equation

$$A_f = (WQ_v) (d_f) / [(k) (h_f + d_f) (t_f)]$$

Where:

- $A_f$  = Surface area of filter bed (ft<sup>2</sup>)
- $d_f$  = Filter bed depth (ft)
- $k$  = Coefficient of permeability of filter media (ft/day)
- $h_f$  = Average height of water above filter bed (ft)
- $t_f$  = Design filter bed drain time (days)  
(1.67 days or 40 hours is recommended maximum  $t_f$  for sand filters, two days for bioretention)



### 6.4.5 Landscaping

#### Required Elements

- A dense and vigorous vegetative cover shall be established over the contributing pervious drainage areas before runoff can be accepted into the facility.
- Landscaping is critical to the performance and function of bioretention areas. Therefore, a landscaping plan must be provided for bioretention areas.

#### Design Guidance

- Surface filters can have a grass cover to aid in pollutant adsorption. The grass should be capable of withstanding frequent periods of inundation and drought.
- Planting recommendations for bioretention facilities are as follows:
  - Native plant species should be specified over non-native species.
  - Vegetation should be selected based on a specified zone of hydric tolerance.
  - A selection of trees with an understory of shrubs and herbaceous materials should be provided.
  - Woody vegetation should not be specified at inflow locations.
  - Trees should be planted primarily along the perimeter of the facility.
  - A tree density of approximately one tree per 100 square feet (i.e., 10 feet on-center) is recommended. Shrubs and herbaceous vegetation should generally be planted at higher densities (five feet on-center and 2.5 feet on center, respectively).

### 6.4.6 Maintenance

#### Required Elements

- A legally binding and enforceable maintenance agreement shall be executed between the facility owner and the local review authority to ensure the following:
  - Sediment shall be cleaned out of the sedimentation chamber when it accumulates to a depth of more than six inches. Vegetation within the sedimentation chamber shall be limited to a height of 18 inches. The sediment chamber outlet devices shall be cleaned/repared when drawdown times exceed 36 hours. Trash and debris shall be removed as necessary.

- Silt/sediment shall be removed from the filter bed when the accumulation exceeds one inch. When the filtering capacity of the filter diminishes substantially (i.e., when water ponds on the surface of the filter bed for more than 48 hours), the top few inches of discolored material shall be removed and shall be replaced with fresh material. The removed sediments shall be disposed in an acceptable manner (i.e., landfill).
- A stone drop of at least six inches shall be provided at the inlet of bioretention facilities (F-6) (pea gravel diaphragm). Areas devoid of mulch shall be re-mulched on an annual basis. Dead or diseased plant material shall be replaced.

#### Design Guidance

- Organic filters or surface sand filters that have a grass cover should be mowed a minimum of three times per growing season to maintain maximum grass heights less than 12 inches.

#### *6.4.7 Cold Climate Design Considerations*

In cold climates, stormwater filtering systems need to be modified to protect the systems from freezing and frost heaving. The primary cold climate concerns to address with regards to filtering systems are:

- Freezing of the filter bed
- Pipe freezing
- Clogging of filter

#### *NOTE*

*ALTHOUGH FILTERING SYSTEMS ARE NOT AS EFFECTIVE DURING THE WINTER, THEY ARE OFTEN EFFECTIVE AT TREATING STORM EVENTS IN AREAS WHERE OTHER SMPS ARE NOT PRACTICAL, SUCH AS IN HIGHLY URBANIZED REGIONS. THUS, THEY MAY BE A GOOD DESIGN OPTION, EVEN IF WINTER FLOWS CANNOT BE TREATED. IT IS ALSO IMPORTANT TO REMEMBER THAT THESE SMPS ARE DESIGNED FOR HIGHLY IMPERVIOUS AREAS. IF THE SNOW FROM THEIR CONTRIBUTING AREAS IS TRANSPORTED TO ANOTHER AREA, SUCH AS A PERVIOUS INFILTRATION AREA, A PRACTICE'S PERFORMANCE DURING THE WINTER SEASON MAY BE LESS CRITICAL TO OBTAIN WATER QUALITY GOALS.*

#### Freezing of the Filter Bed

- Place filter beds for underground filter below the frost line to prevent the filtering medium from freezing during the winter.
- Discourage organic filters using peat and compost media, which are ineffective during the winter in cold climates. These organic filters retain water, and consequently can freeze solid and become completely impervious during the winter.
- Combine treatment with another SMP option that can be used as a backup to the filtering system to provide treatment during the winter when the filter is ineffective

#### Pipe Freezing

- Use a minimum 8" underdrain diameter in a 1' gravel bed. Increasing the diameter of the underdrain makes freezing less likely, and provides a greater capacity to drain standing water from the filter. The porous gravel bed prevents standing water in the system by promoting drainage. Gravel is also less susceptible to frost heaving than finer grained media.
- Replace standpipes with weirs, which can be "frost free." Although weir structures will not always provide detention, they can provide retention storage (i.e., storage with a permanent pool) in the pretreatment chamber.

#### Clogging of Filter with Excess Sand from Runoff

- If a filter is used to treat runoff from a parking lot or roadway that is frequently sanded during snow events, there is a high potential for clogging from sand in runoff. In these cases, the size of the pretreatment chamber should be increased to 40% of the treatment volume. For bioretention systems, a grass strip, such as a swale, of at least twenty-five feet in length should convey flow to the system.
- Filters should always be inspected for sand build-up in the filter chamber following the spring melt event.

## Sand/ Organic Filters



**Description:** Multi-chamber structure designed to treat stormwater runoff through filtration, using a sediment forebay, a primary filter media and, typically, an underdrain collection system.

**Design Variations:**  
 Surface Sand Filter (F-1), Underground Sand Filter (F-2),  
 Perimeter Sand Filter (F-3), Organic Sand Filter (F-4)

<p style="text-align: center;"><b><u>KEY CONSIDERATIONS</u></b></p> <p><b>CONVEYANCE</b></p> <ul style="list-style-type: none"> <li>• If stormwater is delivered by stormdrain, design off-line.</li> <li>• Overflow shall be provided to pass a fraction of the <math>WQ_v</math> to a stabilized watercourse.</li> <li>• Overflow for the ten-year storm to a non-erosive point.</li> <li>• Flow regulator needed to divert <math>WQ_v</math> to the practice, and bypass larger flows.</li> <li>• Underdrain (4" perforated pipe minimum; 6" preferred)</li> </ul> <p><b>PRETREATMENT</b></p> <ul style="list-style-type: none"> <li>• Pretreatment volume of 25% of <math>WQ_v</math>.</li> <li>• Typically a sediment basin with a 1.5:1 L:W ratio, sized with the Camp-Hazen equation (See Section 6.4.3)</li> </ul> <p><b>TREATMENT</b></p> <ul style="list-style-type: none"> <li>• System must hold 75% of the <math>WQ_v</math></li> <li>• Filter media shall be ASTM C-33 sand for sand filters</li> <li>• Organic filters shall be a peat/sand mix, or leaf compost.</li> <li>• Peat shall be reed-sedge hemic peat</li> </ul> <p><b>LANDSCAPING</b></p> <ul style="list-style-type: none"> <li>• Contributing area stabilized before runoff is directed to the facility</li> </ul> <p><b>MAINTENANCE REQUIREMENTS:</b></p> <ul style="list-style-type: none"> <li>• Legally binding maintenance agreement.</li> <li>• Sediment cleaned out of sedimentation chamber when it reaches more than 6" in depth.</li> <li>• Vegetation height limited to 18"</li> <li>• Sediment chamber cleaned if drawdowns exceed 36 hours.</li> <li>• Trash and debris removal</li> <li>• Silt/sediment removed from filter bed after it reaches one inch.</li> <li>• If water ponds on the filter bed for greater than 48 hours, remove material, and replace.</li> </ul>	<p style="text-align: center;"><b><u>STORMWATER MANAGEMENT SUITABILITY</u></b></p> <p><input checked="" type="checkbox"/> <b>Water Quality</b></p> <p><input type="checkbox"/> <b>Channel Protection</b></p> <p><input type="checkbox"/> <b>Overbank Flood Protection</b></p> <p><input type="checkbox"/> <b>Extreme Flood Protection</b></p> <p><b>Accepts Hotspot Runoff: Yes</b>  <i>(requires impermeable liner)</i></p> <p style="text-align: center;"><b><u>IMPLEMENTATION CONSIDERATIONS</u></b></p> <p><input type="checkbox"/> <b>Capital Cost</b></p> <p><input type="checkbox"/> <b>Maintenance Burden</b></p> <p><b>Residential Subdivision Use: No</b>  <b>High Density/Ultra-Urban: Yes</b></p> <p><b>Drainage Area: 2-10 acres max.</b></p> <p><b>Soils: No restrictions</b></p> <p><b>Other Considerations:</b>          Typically needs to be combined with other controls to provide water quantity control</p> <p style="border: 1px solid black; padding: 2px; text-align: center;"><b>Key: L=Low M=Moderate H=High</b></p>
---	---

<b><u>POLLUTANT REMOVAL</u></b>	
<b>G</b>	<b>Phosphorus</b>
<b>G</b>	<b>Nitrogen</b>
<b>G</b>	<b>Metals - Cadmium, Copper, Lead, and Zinc removal</b>
<b>F</b>	<b>Pathogens - Coliform, Streptococci, E.Coli removal</b>
<b>Key: G=Good F=Fair P=Poor</b>	

### Bioretention Areas (F-5)



**Description:** Shallow stormwater basin or landscaped area which utilizes engineered soils and vegetation to capture and treat runoff. The practice is often located in parking lot islands, and can also be used to treat residential areas.

<p style="text-align: center;"><b><u>KEY CONSIDERATIONS</u></b></p> <p><b>CONVEYANCE</b></p> <ul style="list-style-type: none"> <li>• Provide overflow for the 10-year storm to the conveyance system.</li> <li>• Conveyance to the system is typically overland flow delivered to the surface of the system, typically through curb cuts or over a concrete lip.</li> </ul> <p><b>PRETREATMENT</b></p> <ul style="list-style-type: none"> <li>• Pretreatment consists of a grass channel or grass filter strip, a gravel diaphragm, and a mulch layer, sized based on the methodologies described in Section 6.4.2.</li> </ul> <p><b>TREATMENT</b></p> <ul style="list-style-type: none"> <li>• Treatment area should have a four foot deep planting soil bed, a surface mulch layer, and a 6" ponding layer.</li> <li>• Size the treatment area using equations provided in Chapter 6.</li> </ul> <p><b>LANDSCAPING</b></p> <ul style="list-style-type: none"> <li>• Detailed landscaping plan required.</li> </ul> <p><b>MAINTENANCE</b></p> <ul style="list-style-type: none"> <li>• Inspect and repair/replace treatment area components</li> <li>• Stone drop (at least 6") provided at the inlet</li> <li>• Remulch annually</li> </ul>	<p style="text-align: center;"><b><u>STORMWATER MANAGEMENT SUITABILITY</u></b></p> <p><input checked="" type="checkbox"/> <b>Water Quality</b></p> <p><input type="checkbox"/> <b>Channel Protection</b></p> <p><input type="checkbox"/> <b>Overbank Flood Protection</b></p> <p><input type="checkbox"/> <b>Extreme Flood Protection</b></p> <p><b>Accepts Hotspot Runoff: Yes</b> <i>(requires impermeable liner)</i></p>
<p style="text-align: center;"><b><u>POLLUTANT REMOVAL</u></b></p> <p><input type="checkbox"/> <b>G</b> Phosphorus</p> <p><input type="checkbox"/> <b>G</b> Nitrogen</p> <p><input type="checkbox"/> <b>G</b> Metals - Cadmium, Copper, Lead, and Zinc removal</p> <p><input type="checkbox"/> <b>F</b> Pathogens – Coliform, Streptococci, E.Coli removal</p> <p style="text-align: center;">Key: <b>G=Good F=Fair P=Poor</b></p>	<p style="text-align: center;"><b><u>IMPLEMENTATION CONSIDERATIONS</u></b></p> <p><input type="checkbox"/> <b>M</b> Capital Cost</p> <p><input type="checkbox"/> <b>M</b> Maintenance Burden</p> <p><b><u>Residential Subdivision Use: Yes</u></b></p> <p><b>High Density/Ultra-Urban: Yes</b></p> <p><b>Drainage Area: 5 acres max.</b></p> <p><b>Soils: <i>Planting soils must meet specified criteria; No restrictions on surrounding soils</i></b></p> <p><b>Other Considerations:</b></p> <ul style="list-style-type: none"> <li>• <i>Use of native plants is recommended</i></li> </ul> <p style="text-align: center;"><b>Key: L=Low M=Medium H=High</b></p>

**Section 6.5 Open Channel Systems**

Open channel systems are vegetated open channels that are explicitly designed to capture and treat the full  $WQ_v$  within dry or wet cells formed by check dams or other means. Design variants include:

- O-1 Dry Swale (Figure 6.20)
- O-2 Wet Swale (Figure 6.21)

**Treatment Suitability:** Open Channel Systems can meet water quality treatment goals only, and are not appropriate for  $Cp_v$  or  $Q_p$ .

Figure 6.20 Dry Swale (O-1)

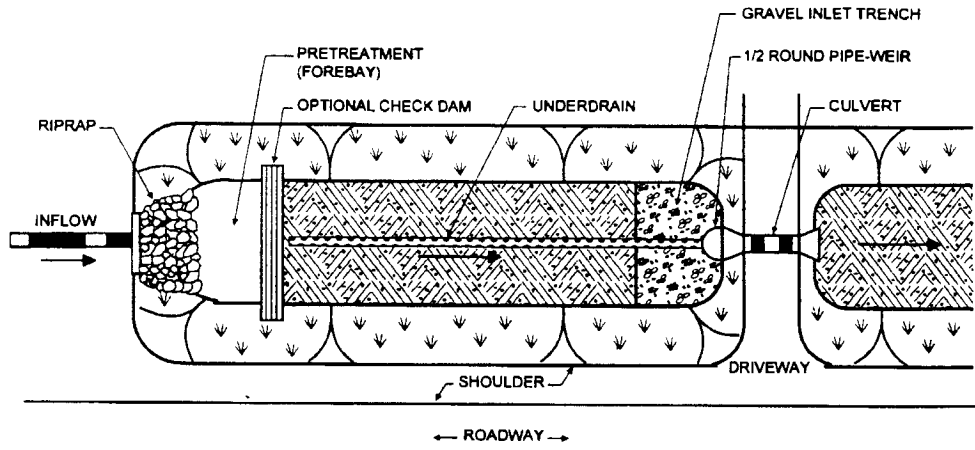

PLAN VIEW

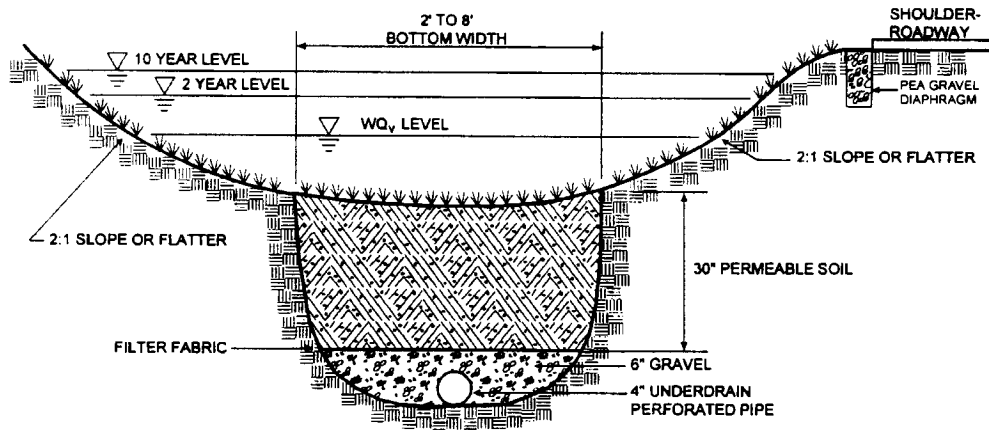

SECTION



Figure 6.21 Wet Swale (O-2)

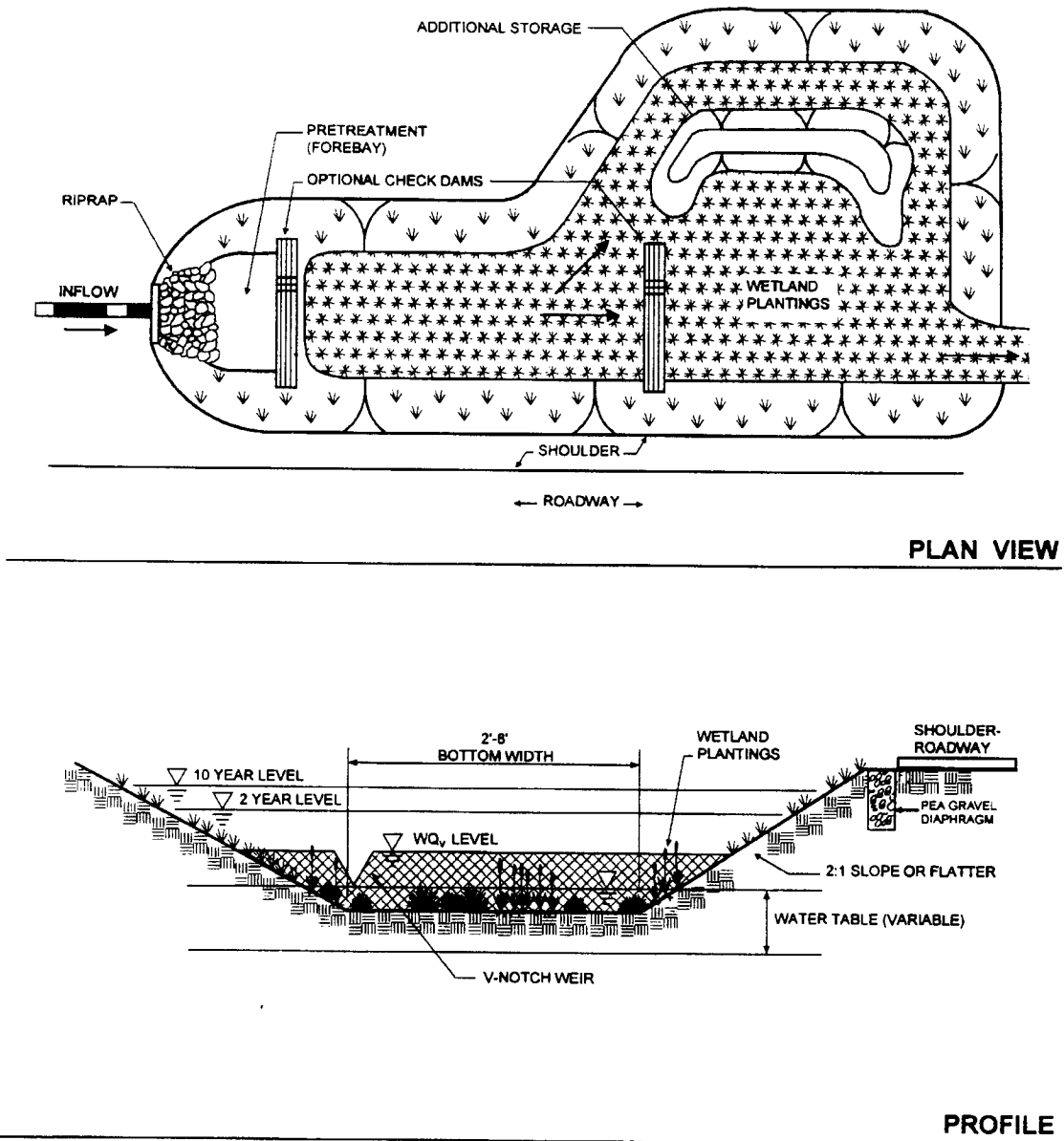

### 6.5.1 Feasibility

#### Required Elements

- The system shall have a maximum longitudinal slope of 4.0%

#### Design Guidance

- Dry Swales (O-1) are primarily applicable for land uses such as roads, highways, residential development, and pervious areas.
- Wet Swales (O-2) should be restricted in residential areas because of the potential for stagnant water and other nuisance ponding.
- Provide a 2' separation distance from groundwater for O-2.

### 6.5.2 Conveyance

#### Required Elements

- The peak velocity for the two-year storm must be non-erosive (i.e., 3.5-5.0 fps). (See Appendix L for a table of erosive velocities for grass and soil).
- Open channels shall be designed to safely convey the ten-year storm with a minimum of 6 inches of freeboard. Note that some agencies or local municipalities may design channel to convey a different design storm.
- The maximum allowable temporary ponding time within a channel shall be less than 48 hours. An underdrain system shall be used in the dry swale to ensure this ponding time.
- Channels shall be designed with moderate side slopes (flatter than 3:1) for most conditions. 2:1 is the absolute maximum side slope.

#### Design Guidance

- Open channel systems which directly receive runoff from impervious surfaces may have a 6 inch (maximum) drop onto a protected shelf (pea gravel diaphragm) to minimize the clogging potential of the inlet.
- The underdrain system should be composed of a 6" gravel bed with a 4" PVC pipe.
- If the site slope is greater than 2%, check dams may be needed to retain the water quality volume within the swale system.

### 6.5.3 Pretreatment

#### Required Elements

- Provide 10% of the  $WQ_v$  in pretreatment. This storage is usually obtained by providing checkdams at pipe inlets and/or driveway crossings.

#### Design Guidance

- Utilize a pea gravel diaphragm and gentle side slopes along the top of channels to provide pretreatment for lateral sheet flows.

### 6.5.4 Treatment

#### Required Elements

- Temporarily store the  $WQ_v$  within the facility to be released over a minimum 30 minute duration.
- Design with a bottom width no greater than eight feet to avoid potential gullyng and channel braiding, but no less than two feet.
- Soil media for the dry swale shall meet the specifications outlined in Appendix H.

#### Design Guidance

- Open channels should maintain a maximum ponding depth of one foot at the mid-point of the channel, and a maximum depth of 18" at the end point of the channel (for storage of the  $WQ_v$ ).

### 6.5.5 Landscaping

#### Design Guidance

- Landscape design should specify proper grass species and wetland plants based on specific site, soils and hydric conditions present along the channel (see Appendix H for landscaping guidance for New York).

### 6.5.6 Maintenance

#### Required Elements

- A legally binding and enforceable maintenance agreement shall be executed between the facility owner and the local review authority to ensure the following:

- Sediment build-up within the bottom of the channel or filter strip is removed when 25% of the original WQ<sub>v</sub> volume has been exceeded.
- Vegetation in dry swales is mowed as required during the growing season to maintain grass heights in the 4 to 6 inch range.

#### 6.5.7 Cold Climate Design Considerations

For open channel systems, the primary cold climate design challenges that need to be addressed are:

- Snowmelt infiltration on frozen ground
- Culvert freezing
- The impacts of deicers on channel vegetation.

##### Snowmelt Infiltration on Frozen Ground

- In order to ensure that the filter bed remains dry between storm events, increase the size of the underdrain pipe to a minimum diameter of 6" with a minimum 1' filter bed.
- The soil bed permeability of the dry swale should be NRCS class SM (NRCS, 1984), which is slightly higher than in the base criteria. This increased permeability will encourage snowmelt infiltration.

##### Culvert Freezing

- Use culvert pipes with a minimum diameter of 18".
- Design culverts with a minimum 1% slope where possible.

##### The Impacts of De-icers on Channel Vegetation

- Inspect open channel systems after the spring melt. At this time, residual sand should be removed and any damaged vegetation should be replaced.
- If roadside or parking lot runoff is directed to the practice, mulching may be required in the spring to restore soil structure and moisture capacity to reduce the impacts of deicing agents.
- Use salt-tolerant plant species in vegetated swales.

## Open Channels



**Description:** Vegetated channels that are explicitly designed and constructed to capture and treat stormwater runoff within dry or wet cells formed by check dams or other means.

**Design Options:**  
Dry Swale (O-1), Wet Swale (O-2)

<u>KEY CONSIDERATIONS</u>	<u>STORMWATER MANAGEMENT SUITABILITY</u>
<p><b>FEASIBILITY</b></p> <ul style="list-style-type: none"> <li>Maximum longitudinal slope of 4%</li> </ul> <p><b>CONVEYANCE</b></p> <ul style="list-style-type: none"> <li>Non-erosive (3.5 to 5.0 fps) peak velocity for the 2-year storm</li> <li>Safe conveyance of the ten-year storm with a minimum of 6 inches of freeboard.</li> <li>Side slopes gentler than 2:1 (3:1 preferred).</li> <li>The maximum allowable temporary ponding time of 48 hours</li> </ul> <p><b>PRETREATMENT</b></p> <ul style="list-style-type: none"> <li>10% of the WQ<sub>v</sub> in pretreatment, usually provided using check dams at culverts or driveway crossings.</li> </ul> <p><b>TREATMENT</b></p> <ul style="list-style-type: none"> <li>Temporary storage the WQ<sub>v</sub> within the facility to be released over a minimum 30 minute duration.</li> <li>Bottom width no greater than 8 feet, but no less than two feet.</li> <li>Soil media as detailed in Appendix H.</li> </ul> <p><b>MAINTENANCE</b></p> <ul style="list-style-type: none"> <li>Removal of sediment build-up within the bottom of the channel or filter strip when 25% of the original WQ<sub>v</sub> volume has been exceeded.</li> <li>Maintain a grass height of 4" to 6" in dry swales.</li> </ul>	<p><input checked="" type="checkbox"/> <b>Water Quality</b></p> <p><input type="checkbox"/> <b>Channel Protection</b></p> <p><input type="checkbox"/> <b>Overbank Flood Protection</b></p> <p><input type="checkbox"/> <b>Extreme Flood Protection</b></p> <p><b>Accepts Hotspot Runoff:</b> <i>Yes (requires impermeable liner)</i></p> <p style="text-align: center;"><u>IMPLEMENTATION CONSIDERATIONS</u></p> <p><input type="checkbox"/> <b>Capital Cost</b></p> <p><input type="checkbox"/> <b>Maintenance Burden</b></p> <p><b>Residential Subdivision Use:</b> <i>Yes</i></p> <p><b>High Density/Ultra-Urban:</b> <i>No</i></p> <p><b>Drainage Area:</b> <i>5 acres max.</i></p> <p><b>Soils:</b> <i>No restrictions</i></p> <p><b>Other Considerations:</b></p> <ul style="list-style-type: none"> <li><i>Permeable soil layer (dry swale)</i></li> <li><i>Wetland plants (wet swale)</i></li> </ul> <p style="border: 1px solid black; padding: 2px;">Key: H=High M=Medium L=Low</p>
<p style="text-align: center;"><u>MANAGEMENT CAPABILITY</u></p> <p><input type="checkbox"/> <b>G</b> Phosphorus</p> <p><input type="checkbox"/> <b>F</b> Nitrogen</p> <p><input type="checkbox"/> <b>G</b> Metals - Cadmium, Copper, Lead, and Zinc removal</p> <p><input type="checkbox"/> <b>P</b> Pathogens - Coliform, Streptococci, E.Coli removal</p> <p style="border: 1px solid black; padding: 2px; text-align: center;">Key: G=Good F=Fair P=Poor</p>	

# Chapter 7

## SMP Selection Matrices

## Chapter 7: SMP Selection

This chapter presents a series of matrices that can be used as a screening process to select the best SMP or group of SMPs for a development site. It also provides guidance for best locating practices on the site. The matrices presented can be used to screen practices in a step-wise fashion. The screening factors include:

1. Land Use
2. Physical Feasibility
3. Watershed/ Regional Factors
4. Stormwater Management Capability
5. Community and Environmental Factors

The five matrices presented here are not exhaustive. Specific additional criteria may be incorporated depending on local design knowledge and resource protection goals. Furthermore, many communities may wish to eliminate some of the selection factors presented in this section. Caveats for the application of each matrix are included in the detailed description of each.

More detail on the proposed step-wise screening process is provided below:

### **Step 1 Land Use**

*Which practices are best suited for the proposed land use at this site?* In this step, the designer makes an initial screen to select practices that are best suited to a particular land use.

### **Step 2 Physical Feasibility Factors**

*Are there any physical constraints at the project site that may restrict or preclude the use of a particular SMP?* In this step, the designer screens the SMP list using Matrix No. 2 to determine if the soils, water table, drainage area, slope or head conditions present at a particular development site might limit the use of a SMP.

### **Step 3 Watershed Factors**

*What watershed protection goals need to be met in the resource my site drains to?* Matrix No.3 outlines SMP goals and restrictions based on the resource being protected.

**Step 4 Stormwater Management Capability**

*Can one SMP meet all design criteria, or is a combination of practices needed?* In this step, designers can screen the SMP list using Matrix No. 4 to determine if a particular SMP can meet water quality, channel protection, and flood control storage requirements. At the end of this step, the designer can screen the SMP options down to a manageable number and determine if a single SMP or a group of SMPs is needed to meet stormwater sizing criteria at the site.

**Step 5 Community and Environmental Factors**

*Do the remaining SMPs have any important community or environmental benefits or drawbacks that might influence the selection process?* In this step, a matrix is used to compare the SMP options with regard to cold climate restrictions, maintenance, habitat, community acceptance, cost and other environmental factors.



**Section 7.1 Land Use**

This matrix allows the designer to make an initial screen of practices most appropriate for a given land use (Table 7.1).

*Rural.* This column identifies SMPs that are best suited to treat runoff in rural or very low density areas (e.g., typically at a density of less than ½ dwelling unit per acre).

*Residential.* This column identifies the best treatment options in medium to high density residential developments.

*Roads and Highways.* This column identifies the best practices to treat runoff from major roadways and highway systems.

*Commercial Development.* This column identifies practices that are suitable for new commercial development

*Hotspot Land Uses.* This last column examines the capability of an SMP to treat runoff from designated hotspots (see Appendix A). An SMP that receives hotspot runoff may have design restrictions, as noted.

*Ultra-Urban Sites.* This column identifies SMPs that work well in the ultra-urban environment, where space is limited and original soils have been disturbed. These SMPs are frequently used at redevelopment sites.

Table 7.1 Land Use Selection Matrix

SMP Group	SMP Design	Rural	Residential	Roads and Highways	Commercial/High Density	Hotspots	Ultra Urban
Pond	Micropool ED	○	○	○	◐	①	●
	Wet Pond	○	○	○	◐	①	●
	Wet ED Pond	○	○	○	◐	①	●
	Multiple Pond	○	○	◐	◐	①	●
	Pocket Pond	○	◐	○	◐	●	●
Wetland	Shallow Wetland	○	○	◐	◐	①	●
	ED Wetland	○	○	◐	◐	①	●
	Pond/Wetland	○	○	●	◐	①	●
	Pocket Wetland	○	◐	○	◐	●	●
Infiltration	Infiltration Trench	◐	◐	○	○	●	◐
	Shallow I-Basin	◐	◐	◐	◐	●	◐
	Dry Well <sup>1</sup>	◐	○	●	◐	●	◐
Filters	Surface Sand Filter	●	◐	○	○	②	○
	Underground SF	●	●	◐	○	○	○
	Perimeter SF	●	●	◐	○	○	○
	Organic SF	●	◐	○	○	②	○
	Bioretention	◐	◐	○	○	②	○
Open Channels	Dry Swale	○	◐	○	◐	②	◐
	Wet Swale	○	●	○	●	●	●

○: Yes. Good option in most cases.  
 ◐: Depends. Suitable under certain conditions, or may be used to treat a portion of the site.  
 ●: No. Seldom or never suitable.  
 ①: Acceptable option, but may require a pond liner to reduce risk of groundwater contamination.  
 ②: Acceptable option, if not designed as an exfilter.  
 1: The dry well can only be used to treat rooftop runoff

**Section 7.2 Physical Feasibility Factors**

This matrix allows the designer to evaluate possible options based on physical conditions at the site (Table 7.2). More detailed testing protocols are often needed to confirm physical conditions at the site. Five primary factors are:

*Soils.* The key evaluation factors are based on an initial investigation of the NRCS hydrologic soils groups at the site. Note that more detailed geotechnical tests are usually required for infiltration feasibility and during design to confirm permeability and other factors. Appendix H describes geotechnical testing requirements for New York State.

*Water Table.* This column indicates the minimum depth to the seasonally high water table from the bottom elevation, or floor, of an SMP.

*Drainage Area.* This column indicates the minimum or maximum drainage area that is considered optimal for a practice. If the drainage area present at a site is slightly greater than the maximum allowable drainage area for a practice, some leeway is warranted where a practice meets other management objectives. Likewise, the minimum drainage areas indicated for ponds and wetlands should not be considered inflexible limits, and may be increased or decreased depending on water availability (baseflow or groundwater), mechanisms employed to prevent clogging, or the ability to assume an increased maintenance burden.

*Slope.* This column evaluates the effect of slope on the practice. Specifically, the slope guidance refers to how flat the area where the practice is installed must be and/or how steep the contributing drainage area or flow length can be.

*Head.* This column provides an estimate of the elevation difference needed for a practice (from the inflow to the outflow) to allow for gravity operation.

Table 7.2 Physical Feasibility Matrix						
SMP Group	SMP Design	Soils	Water Table	Drainage Area (acres)	Site Slope	Head (ft)
Pond	Micropool ED	HSG A soils may require pond liner.	2 foot separation if hotspot or aquifer	10 min <sup>1</sup>	No more than 15%	6 to 8 ft
	Wet Pond			25 min <sup>1</sup>		
	Wet ED Pond					
	Multiple Pond					
	Pocket Pond	OK	below WT	5 max <sup>2</sup>		4 ft
Wetland	Shallow Wetland	HSG A soils may require liner	2 foot separation if hotspot or aquifer	25 min	No more than 8%	3 to 5 ft
	ED Wetland					
	Pond/Wetland					
	Pocket Wetland	OK	below WT	5 max		2 to 3 ft
Infiltration	Infiltration Trench	f <sub>c</sub> > 0.5 inch/hr; additional pretreatment required over 2.0 in/hr (See Section 6.3.3)	3 feet, 4 feet if sole source aquifer.	5 max	No more than 15%	1 ft <sup>6</sup>
	Shallow I-Basin			10 max <sup>3</sup>		3 ft
	Dry Well			1 max <sup>4</sup>		1 ft
Filters	Surface SF	OK	2 feet <sup>5</sup>	10 max <sup>2</sup>	No more than 6%	5 ft
	Underground SF			2 max <sup>2</sup>		5 to 7ft
	Perimeter SF			2 max <sup>2</sup>		2 to 3 ft
	Organic SF			5 max <sup>2</sup>		2 to 4 ft
	Bioretention			5 max <sup>2</sup>		5 ft
	Dry Swale	Made Soil	3 to 5 ft			
Open Channels	Wet Swale	Made Soil	2 feet	5 max	No more than 4%	1 ft
	Wet Swale	OK	below WT	5 max		1 ft

Notes:

- 1: Unless adequate water balance and anti-clogging device installed
- 2: Drainage area can be larger in some instances
- 3: May be larger in areas where the soil percolation rate is greater than 5.0 in/hr
- 4: Designed to treat rooftop runoff only
- 5: If designed with a permeable bottom, must meet the depth requirements for infiltration practices.
- 6: Required ponding depth above geotextile layer.

**Section 7.3 Watershed/Regional Factors**

The choices made by the designer should be influenced to some extent by the resource being protected, and the region of New York State where the site is located. The following matrices (Tables 7.3a and 7.3b) present some design considerations for six watershed or regional factors in New York:

*Sensitive Streams.* The guidance presented here should apply to all trout waters and Class N waters, and any streams that support high biodiversity and water quality, and have a low density of development.

*Aquifers.* In sole source aquifers, special care should be taken to select practices and incorporate design considerations that protect the groundwater quality. Figure 7.1 depicts sole source aquifers in the State of New York.

**Figure 7.1 Sole Source Aquifers in New York State**

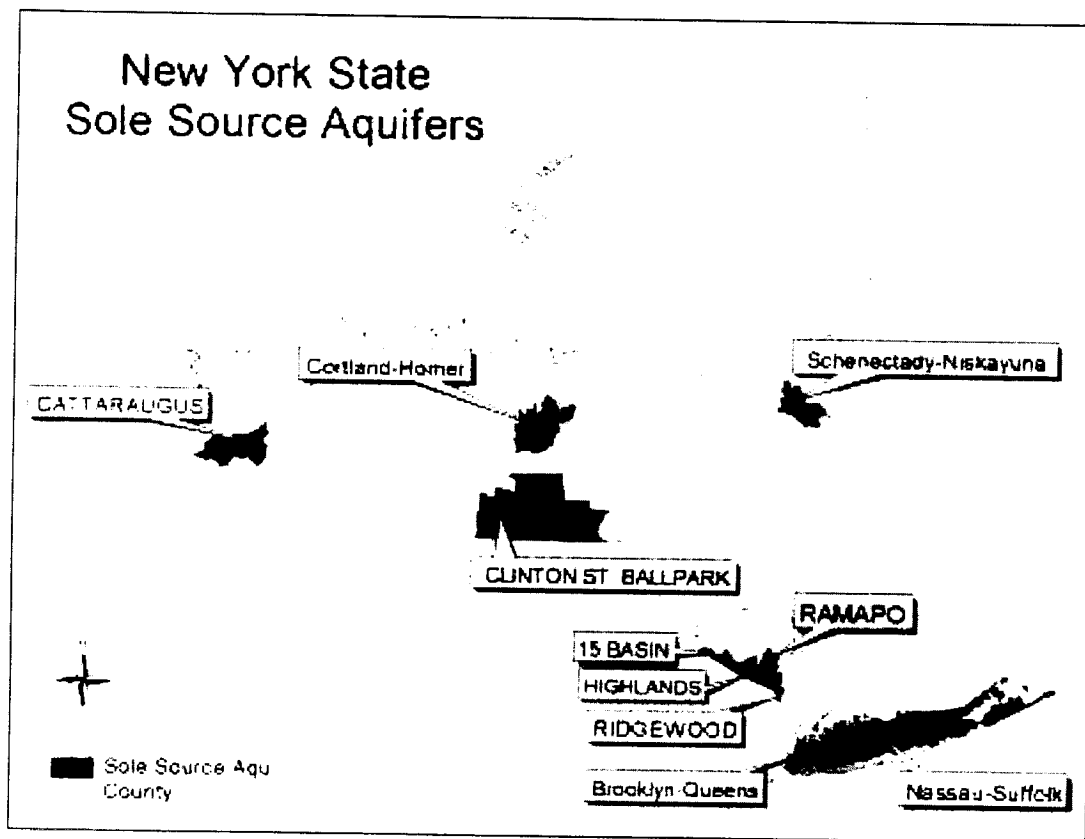

*Lakes.* Lakes are of particular concern in New York, which has many natural lake systems and borders on two Great Lakes. The information in this matrix focuses on phosphorous removal, which is an important concern in most lake systems. It is important to note, however, that many lakes in New York State have other important issues to address. Some lakes, such as Lake Onondoga, have other specific concerns, such as toxics and metals. Each community should also take these goals into consideration when reviewing site plans.

**Table 7.3a Watershed/ Regional Selection Matrix-1**

<b>SMP Group</b>	<b>Sensitive Stream</b>	<b>Aquifer</b>	<b>Lakes</b>
<b>Ponds</b>	Emphasize channel protection. Restrict in-stream practices. In trout waters, minimize permanent pool area, and encourage shading.	May require liner if HSG A soils are present.  Pretreat 100% of WQ <sub>v</sub> from hotspots.  Provide a 2' separation distance to water table.	Encourage the use of a large permanent pool to improve phosphorus removal.
	<b>Wetlands</b>		
<b>Infiltration</b>	Require channel protection. Restrict in-stream practices. Restrict use in trout waters.	Provide 100' horizontal separation distance from wells and 4' vertical distance from the water table.	OK. Provides high phosphorus removal.
	Strongly encourage use for groundwater recharge. Combine with a detention facility to provide channel protection.		
<b>Filtering Systems</b>	Combine with a detention facility to provide channel protection.	Excellent pretreatment for infiltration or open channel practices.	OK, but designs with a submerged filter may result in phosphorus release.
<b>Open Channels</b>	Combine with a detention facility to provide channel protection.	OK, but hotspot runoff must be adequately pretreated	OK. Moderate P removal.

*Reservoirs.* For drinking water reservoirs, and in particular for unfiltered water supplies such as the New York City Reservoir system, turbidity, phosphorous removal, and bacteria are of particular concern. A particular reservoir may have other specific concerns, which should be identified as part of a Source Water Assessment.

*Estuary/Coastal.* In New York State, coastal or estuary areas include the South Shore Estuary Reserve, Peconic Estuary, NY/NJ Harbor, and Hudson River Estuary. In these areas, nitrogen is typically a concern due to potential eutrophication. In addition, bacteria control is important to protect shellfish beds.

*Cold Climates.* Many portions of New York State experience cold or very snowy winters. This matrix summarizes some of the design considerations in these cold climate areas. For more detailed information, consult Chapter 6, which provides cold climate design guidance for each group of SMPs.

<b>Table 7.3b Watershed/Regional Selection Matrix-2</b>			
<b>SMP Group</b>	<b>Reservoir</b>	<b>Estuary/Coastal</b>	<b>Cold Climates</b>
<b>Ponds</b>	Encourage the use of a large permanent pool to improve sediment and phosphorous removal.  Promote long detention times to encourage bacteria removal.	Encourage long detention times to promote bacteria removal.  Provides high nitrogen removal.  In flat coastal areas, a pond drain may not be feasible.	Incorporate design features to improve winter performance.
<b>Wetlands</b>			Encourage the use of salt-tolerant vegetation.
<b>Infiltration</b>	Provide a separation distance from bedrock and water table  Pretreat runoff prior to infiltration practices.	OK, but provide a separation distance to seasonally high groundwater.  In the sandy soils typical of coastal areas, additional pretreatment may be required (See Section 6.3.3)	Incorporate features to minimize the risk of frost heave.  Discourage infiltration of chlorides.
<b>Filtering Systems</b>	Excellent pretreatment for infiltration or open channel practices.  Moderate to high coliform removal	Moderate to high coliform removal  Designs with a submerged filter bed appear to have very high nitrogen removal	Incorporate design features to improve winter performance.
<b>Open Channels</b>	Poor coliform removal for wet swales.	Poor coliform removal for grass wet swales.	Encourage the use of salt-tolerant vegetation.



**Section 7.4 Stormwater Management Capability**

This matrix examines the capability of each SMP option to meet stormwater management criteria (Table 7.4). It shows whether an SMP can meet requirements for:

*Water Quality.* The matrix summarizes the relative pollutant removal of each practice for nitrogen, metals, and bacteria. All of the practices approved for water quality achieve at least 80% TSS and 40% TP removal. For more detailed information, consult Appendix A, which describes the application of the Simple Method in New York State. Pollutant removals are based a comprehensive pollutant removal database produced by the Center for Watershed Protection (Winer, 2000).

*Channel Protection.* The matrix indicates whether the SMP can typically provide channel protection storage. The finding that a particular SMP cannot meet the channel protection requirement does not necessarily imply that the SMP should be eliminated from consideration, but is a reminder that more than one practice may be needed at a site (e.g., a bioretention area and a downstream ED pond).

*Flood Control* The matrix shows whether an SMP can typically meet the overbank flooding criteria for the site. Again, the finding that a particular SMP cannot meet the requirement does not necessarily mean that it should be eliminated from consideration, but rather is a reminder that more than one practice may be needed at a site (e.g., a bioretention area and a downstream stormwater detention pond).

Table 7.4 Stormwater Management Capability Matrix						
SMP Group	SMP Design	Water Quality			Channel Protection	Flood Control
		Nitrogen	Metals	Bacteria		
Pond	Micropool ED	○	○	○	○	○
	Wet Pond				○	○
	Wet ED Pond				○	○
	Multiple Pond				○	○
	Pocket Pond				○	○
Wetland	Shallow Wetland	○	●	○	○	○
	ED Wetland				○	○
	Pond/Wetland				○	○
	Pocket Wetland				○	①
Infiltration	Infiltration Trench	○	○	○	●	●
	Shallow I-Basin				②	②
	Dry Well				●	●
Filters	Surface Sand Filter	○	○	●	①	●
	Underground SF				●	●
	Perimeter SF				●	●
	Organic SF				●	●
	Bioretention				①	●
	Dry Swale				●	●
Open Channels	Wet Swale	●	○	●	●	●
	Wet Swale				●	●

○: Good option for meeting management goal  
 Good pollutant removal (>30% TN, >60% Metals, >70% Bacteria)  
 ●: Cannot meet management goal.  
 Poor pollutant removal (<15% TN, <30 Metals, <35% Bacteria)  
 ①: In most cases, cannot meet this goal, but the design may be adapted to add storage.  
 ②: Generally cannot meet this goal, except in areas with soil percolation rates greater than 5.0 in/hr

**Section 7.5 Community and Environmental Factors**

The last step assesses community and environmental factors involved in SMP selection. This matrix employs a comparative index approach (Table 7.5.). An open circle indicates that the SMP has a high benefit and a dark circle indicates that the particular SMP has a low benefit.

*Ease of Maintenance.* This column assesses the relative maintenance effort needed for an SMP, in terms of three criteria: frequency of scheduled maintenance, chronic maintenance problems (such as clogging) and reported failure rates. It should be noted that **all SMPs** require routine inspection and maintenance.

*Community Acceptance.* This column assesses community acceptance, as measured by three factors: market and preference surveys, reported nuisance problems, and visual orientation (i.e., is it prominently located or is it in a discrete underground location). It should be noted that a low rank can often be improved by a better landscaping plan.

*Affordability.* The SMPs are ranked according to their relative construction cost per impervious acre treated.

*Safety.* A comparative index that expresses the relative safety of an SMP. An open circle indicates a safe SMP, while a darkened circle indicates deep pools may create potential safety risks. The safety factor is included at this stage of the screening process because liability and safety are of paramount concern in many residential settings.

*Habitat.* SMPs are evaluated on their ability to provide wildlife or wetland habitat, assuming that an effort is made to landscape them appropriately. Objective criteria include size, water features, wetland features and vegetative cover of the SMP and its buffer.

Table 7.5 Community and Environmental Factors Matrix						
SMP Group	SMP List	Ease of Maintenance	Community Acceptance	Affordability	Safety	Habitat
Ponds	Micropool ED	●	●	○	○	●
	Wet Pond	○	○	○	●	○
	Wet ED Pond	○	○	○	●	○
	Multiple Pond	○	○	●	●	○
	Pocket Pond	●	●	○	●	●
Wetlands	Shallow Wetland	●	○	●	○	○
	ED Wetland	●	●	●	●	○
	Pond/Wetland	○	○	●	●	○
	Pocket Wetland	●	●	○	○	●
Infiltration	Infiltration Trench	●	○	●	○	●
	Shallow I-Rasin	●	●	●	○	●
	Dry Well	●	●	●	○	●
Filters	Surface SF	●	●	●	○	●
	Underground SF	●	○	●	●	●
	Perimeter SF	●	○	●	○	●
	Organic SF	●	○	●	○	●
	Bioretention	●	●	●	○	●
Open Channels	Dry Swale	○	○	●	○	●
	Wet Swale	○	●	○	○	●

# Chapter 8

## Stormwater Management Design Examples

## Chapter 8: Stormwater Management Design Examples

This chapter presents design examples for two hypothetical development sites in the State of New York. The first site, “Stone Hill Estates,” is a residential development near Ithaca. The second is a commercial site in Albany. The chapter is divided into five sections, each of which focuses on a particular element of stormwater management design.

- Section 8.1 provides an example of detailed hydrology calculations at the residential site.
- Section 8.2 presents a pond design example based on the hydrology calculated in Section 8.1. This design example demonstrates the hydrologic and hydraulic computations to achieve water quality and water quantity control for stormwater management. Other specific dam design criteria such as soil compaction, structural appurtenances, embankment drainage, outlet design, gates, reservoir drawdown requirements, etc. are stated in Guidelines For Design of Dams.
- This design example in Section 8.2 requires an Article 15 Permit from NYS-DEC since the dam is 15 feet high measured from the top of dam to the low elevation at the downstream outlet, and the storage measured behind the structure to the top of the dam is 2.2 MG.
- Sections 8.3 through 8.5 present design examples for three practices on the commercial site: a sand filter, infiltration trench, and bioretention practice.

**Section 8.1 Sizing Example - Stone Hill Estates**

Following is a sizing example for the hypothetical “Stone Hill Estates,” a 45-acre residential development in Ithaca, New York (Figure 8.1). The site also drains approximately 20 acres of off-site drainage, which is currently in a meadow condition. The site is on mostly C soils with some D soils.

**Figure 8.1 Stone Hill Site Plan**

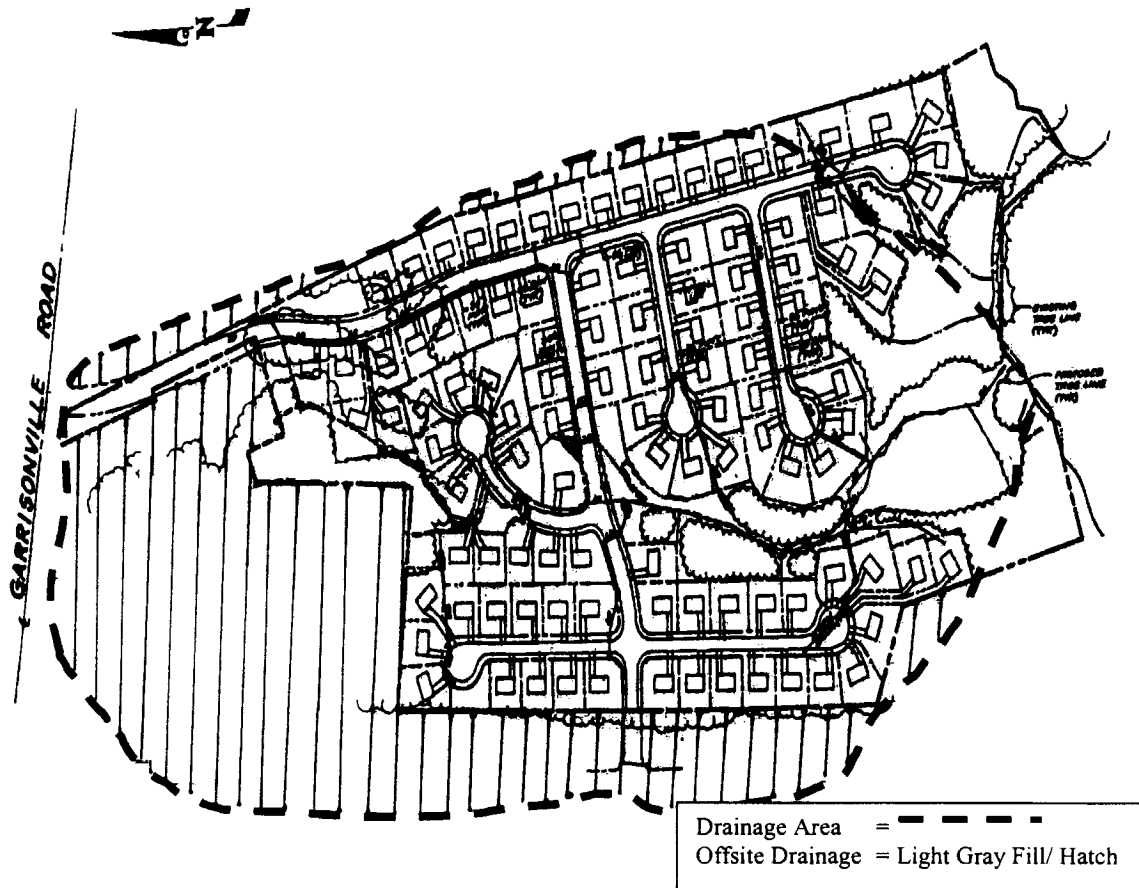

Base Data

Location: Ithaca, NY  
 Site Area = 45.1 ac; Offsite Area = 20.0 ac (meadow)  
 Total Drainage Area (A) = 65.1  
 Measured Impervious Area=12.0 ac;  
 Site Soils Types: 78% “C”, 22% “D”  
 Offsite Soil Type: 100% “C”  
 Zoning: Residential (½ acre lots)

Hydrologic Data

	<u>Pre</u>	<u>Post</u>	<u>Ult.</u>
CN	72	78	82
t <sub>c</sub> (hr)	.46	.35	.35

**Computation of Preliminary Stormwater Storage Volumes and Peak Discharges**

The layout of the Stone Hill subdivision is shown on the previous page.

**Water Quality Volume, WQ<sub>v</sub>**

- Compute Impervious Cover

Use both on-site and off-site drainage:

$$I = 12.0 \text{ acres} / 65.1 \text{ acres}$$

$$= 18.4\%$$

- Compute Runoff Coefficient, R<sub>v</sub>

$$R_v = 0.05 + (I) (0.009)$$

$$= 0.05 + (18.4) (0.009) = 0.22$$

- Compute WQ<sub>v</sub> (Includes both on-site and off-site drainage)

Use the 90% capture rule with 0.9" of rainfall. (From Figure 4.1)

$$WQ_v = (0.9") (R_v) (A)$$

$$= (0.9") (0.22) (65.1 \text{ ac}) (1\text{ft}/12\text{in})$$

$$= \underline{1.07 \text{ ac-ft}}$$

**Establish Hydrologic Input Parameters and Develop Site Hydrology (see Figures 8.2, 8.3, and 8.4)**

Condition	Area	CN	Tc
	Ac		hrs
Pre-developed	65.1	72	0.46
Post-developed	65.1	78	0.35
Ultimate buildout*	65.1	82	0.35

\*Zoned land use in the drainage area.

Hydrologic Calculations

Condition	Q <sub>1-yr</sub>	Q <sub>1-yr</sub>	Q <sub>10-yr</sub>	Q <sub>100-yr</sub>
Runoff	inches	cfs	cfs	cfs
Pre-developed	0.4	19	72	141
Post-developed	0.7	38	112	202
Ultimate buildout	NA	NA	NA	227



PEAK DISCHARGE SUMMARY				
JOB: STONE HILL				
DRAINAGE AREA NAME: PRE DEVELOPMENT		EWB 21-Jan-97		
COVER DESCRIPTION	SOIL NAME	GROUP A,B,C,D?	Curve	AREA (In acres)
MEADOW		C	71	20.25 Ac.
MEADOW		D	78	7.95 Ac.
WOOD		C	70	15.09 Ac.
WOOD		D	77	1.81 Ac.
OFF-SITE MEADOW		C	71	20.00 Ac.
AREA SUBTOTALS:				65.10 Ac.
Time of Concentration	Surface Cover Cross Section	Manning 'n' Wetted Per	Flow Length Avg Velocity	Slope Tt (Hrs)
2-Yr 24 Hr Rainfall = 2.7 In				
Sheet Flow	dense grass	n'=0.24	150 Ft.	3.80% 0.28 Hrs
Shallow Flow	UNPAVED		1300 Ft. 2.65 F.P.S.	2.70% 0.14 Hrs.
Channel Flow Hydraulic Radius =1.26	22.0 SqFt	n'=0.040 17.5 Ft.	1100 Ft. 7.14 F.P.S.	2.70% 0.04 Hrs.
Total Area in Acres =	65.10 Ac.	Total Sheet Flow=	Total Shallow Flow=	Total Channel Flow =
Weighted CN =	72	0.28 Hrs.	0.14 Hrs.	0.04 Hrs.
Time Of Concentration =	0.46 Hrs.	RAINFALL TYPE II		
Pond Factor =	1			
STORM	Precipitation (P) inches	Runoff (Q)	Qp, PEAK DISCHARGE	TOTAL STORM Volumes
1 Year	2.3 In.	0.4 In.	18.6 CFS	101,195 Cu. Ft.
2 Year	2.7 In.	0.6 In.	30.2 CFS	150,257 Cu. Ft.
10 Year	3.9 In.	1.4 In.	72 CFS	328,570 Cu. Ft.
100 Year	5.5 In.	2.6 In.	141 CFS	611,958 Cu. Ft.

Figure 8.2 Stone Hill Pre-Development Conditions

PEAK DISCHARGE SUMMARY				
JOB: STONE HILL				
DRAINAGE AREA NAME: POST DEVELOPMENT		EWB 21-Jan-97		
COVER DESCRIPTION	SOIL NAME	GROUP A,B,C,D?	Curve	AREA (In acres)
MEADOW		C	71	0.16 Ac.
MEADOW		D	78	0.14 Ac.
WOOD		C	70	3.09 Ac.
WOOD		D	77	1.81 Ac.
IMPERVIOUS			98	12.00 Ac.
GRASS		C	74	20.09 Ac.
GRASS		D	80	7.81 Ac.
OFFSITE MEADOW		C	71	20.00 Ac.
<b>AREA SUBTOTALS:</b>				<b>65.10 Ac.</b>
Time of Concentration	Surface Cover Cross Section	Manning 'n' Wetted Per	Flow Length Avg Velocity	Slope Tt (Hrs)
2-Yr 24 Hr Rainfall = 2.7 In				
<b>Sheet Flow</b>	dense grass	n'=0.24	100 Ft.	3.80% 0.20 Hrs
<b>Shallow Flow (a)</b>	UNPAVED		100 Ft. 1.98 F.P.S.	1.50% 0.01 Hrs.
<b>(b)</b>	PAVED		400 Ft. 2.03 F.P.S.	1.00% 0.05 Hrs.
<b>Channel Flow (a)</b>		n'=0.013	1550 Ft.	1.00%
Hydraulic Radius =0.50	1.6 SqFt	3.2 Ft.	7.22 F.P.S.	0.06 Hrs.
<b>(b)</b>		n'=0.030	350 Ft.	4.30%
Hydraulic Radius =1.42	12.0 SqFt	8.5 Ft.	13.01 F.P.S.	0.01 Hrs.
<b>(c)</b>		n'=0.040	300 Ft.	3.30%
Hydraulic Radius =1.26	22.0 SqFt	8.5 Ft.	7.89 F.P.S.	0.01 Hrs.
<b>Total Area in Acres =</b>	<b>65.10 Ac.</b>	<b>Total Sheet Flow=</b>	<b>Total Shallow Flow=</b>	<b>Total Channel Flow =</b>
<b>Weighted CN =</b>	<b>78</b>	<b>0.20 Hrs.</b>	<b>0.07 Hrs.</b>	<b>0.08 Hrs.</b>
<b>Time Of Concentration =</b>	<b>0.35 Hrs.</b>	<b>RAINFALL TYPE II</b>		
<b>Pond Factor =</b>	<b>1</b>			
<b>STORM</b>	Precipitation (P) inches	Runoff (Q)	Qp, PEAK DISCHARGE	TOTAL STORM Volumes
1 Year	2.3 In.	0.7 In.	37.6 CFS	156,283 Cu. Ft.
2 Year	2.7 In.	0.9 In.	54.0 CFS	217,511 Cu. Ft.
10 Year	3.9 In.	1.8 In.	112 CFS	427,155 Cu. Ft.
100 Year	5.5 In.	3.1 In.	202 CFS	742,265 Cu. Ft.

Figure 8.3 Stone Hill Post-Development Conditions

PEAK DISCHARGE SUMMARY				
JOB: STONE HILL				EWB 21-Jan-97
DRAINAGE AREA NAME: ULTIMATE BUILDOUT				
COVER DESCRIPTION	SOIL NAME	GROUP A,B,C,D?	Curve	AREA (In acres)
MEADOW		C	71	0.16 Ac.
MEADOW		D	78	0.14 Ac.
WOOD		C	70	3.09 Ac.
WOOD		D	77	1.81 Ac.
IMPERVIOUS			98	12.00 Ac.
GRASS		C	74	20.09 Ac.
GRASS		D	80	7.81 Ac.
OFFSITE ULTIMATE SF RES (0.25 AC LOTS)		C	83	20.00 Ac.
<b>AREA SUBTOTALS:</b>				<b>65.10 Ac.</b>
Time of Concentration	Surface Cover Cross Section	Manning 'n' Wetted Per	Flow Length Avg Velocity	Slope Tt (Hrs)
2-Yr 24 Hr Rainfall = 2.7 In				
<b>Sheet Flow</b>	dense grass	'n'=0.24	100 Ft.	3.80% 0.20 Hrs
<b>Shallow Flow (a)</b>	UNPAVED		100 Ft. 1.98 F.P.S.	1.50% 0.01 Hrs.
<b>(b)</b>	PAVED		400 Ft. 2.03 F.P.S.	1.00% 0.05 Hrs.
<b>Channel Flow (a)</b>		'n'=0.013 3.2 Ft.	1550 Ft. 7.22 F.P.S.	1.00% 0.06 Hrs.
<b>(b)</b>		'n'=0.030 8.5 Ft.	350 Ft. 13.01 F.P.S.	4.30% 0.01 Hrs.
<b>(c)</b>		'n'=0.040 8.5 Ft.	300 Ft. 7.89 F.P.S.	3.30% 0.01 Hrs.
<b>Total Area in Acres =</b>	<b>65.10 Ac.</b>	<b>Total Sheet Flow=</b>	<b>Total Shallow Flow=</b>	<b>Total Channel Flow =</b>
<b>Weighted CN =</b>	<b>82</b>	<b>0.20 Hrs.</b>	<b>0.07 Hrs.</b>	<b>0.08 Hrs.</b>
<b>Time Of Concentration =</b>	<b>0.35 Hrs.</b>	<b>RAINFALL TYPE II</b>		
<b>Pond Factor =</b>	<b>1</b>			
<b>STORM</b>	<b>Precipitation (P) inches</b>	<b>Runoff (Q)</b>	<b>Qp, PEAK DISCHARGE</b>	<b>TOTAL STORM Volumes</b>
1 Year	2.3 In.	0.9 In.	50.9 CFS	201,772 Cu. Ft.
2 Year	2.7 In.	1.1 In.	70.0 CFS	271,097 Cu. Ft.
10 Year	3.9 In.	2.1 In.	135 CFS	500,458 Cu. Ft.
100 Year	5.5 In.	3.5 In.	227 CFS	834,167 Cu. Ft.

Figure 8.4 Stone Hill Ultimate Buildout Conditions

**Compute Stream Channel Protection Volume, (C<sub>p</sub>) (see Section 4.3 and Appendix B)**

For stream channel protection, provide 24 hours of extended detention (T) for the one-year event.

Compute Channel Protection Storage Volume

First, determine the value of the unit peak discharge (q<sub>u</sub>) using TR-55 and Type II Rainfall Distribution

- Initial abstraction (I<sub>a</sub>) for CN of 78 is 0.564: [I<sub>a</sub> = (200/CN - 2)]
- I<sub>a</sub>/P = (0.564)/ 2.3 inches = 0.245
- T<sub>c</sub> = 0.35 hours
- Using the above data, q<sub>u</sub> = 570 csm/in (cubic feet per second per square mile per year)

**Figure 8.5 Detention Time vs. Discharge Ratios (Source: MDE, 2000)**

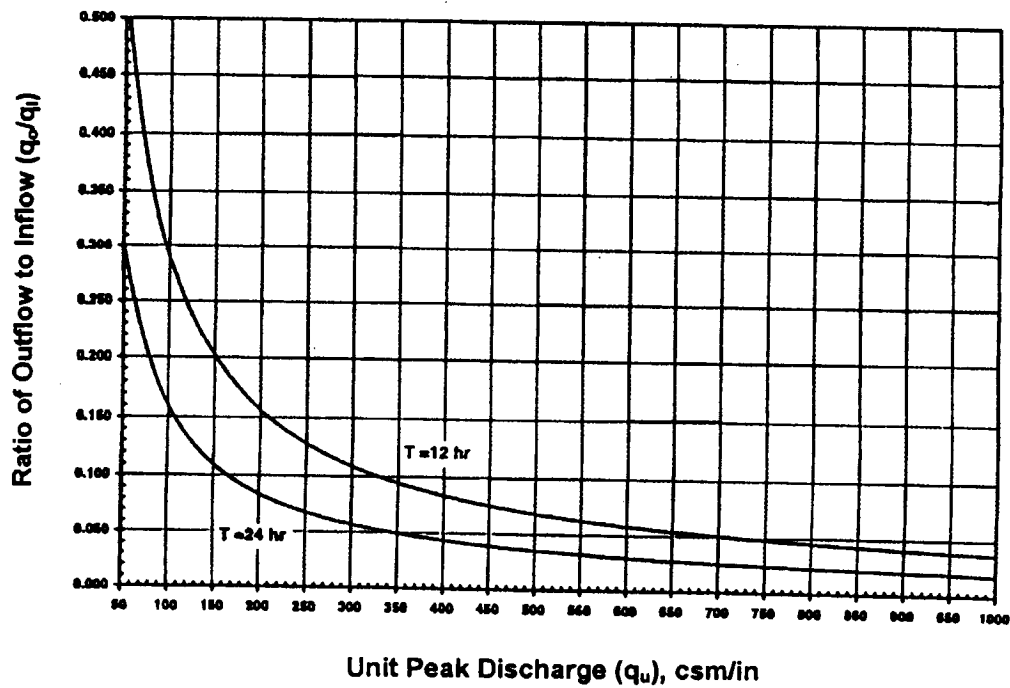

- Knowing  $q_o$  and  $T = 24$  hours, find  $q_o/q_i$  using Figure 8.5 (also see methodology in Appendix B)
- Peak outflow discharge/peak inflow discharge ( $q_o/q_i$ ) = 0.035
- $V_s/V_r = 0.683 - 1.43(q_o/q_i) + 1.64(q_o/q_i)^2 - 0.804(q_o/q_i)^3$  (from Appendix B)

Where  $V_s$  equals channel protection storage ( $C_{p_v}$ ) and  $V_r$  equals the volume of runoff in inches.

- $V_s/V_r = 0.63$  and, from figure 8.3,  $Q = 0.7''$
- Solving for  $V_s$

$$V_s = C_{p_v} = 0.63(0.7'')(1/12)(65.1 \text{ ac}) = 2.4 \text{ ac-ft (104,214 cubic feet)}$$

#### Define the Average Release Rate

- The above volume, 2.4 ac-ft, is to be released over 24 hours
- $(2.4 \text{ ac-ft} \times 43,560 \text{ ft}^2/\text{ac}) / (24 \text{ hrs} \times 3,600 \text{ sec/hr}) = 1.2 \text{ cfs}$

#### **Compute Overbank Flood Protection Volume, ( $Q_{p_{10}}$ ) (see Section 4.4)**

For both the overbank flood protection volume and the extreme flood protection volume, size is determined using the TR-55 "Short-Cut Method," which relates the storage volume to the required reduction in peak flow and storm inflow volume (Figure 8.6).

- For a  $q_i$  of 112 cfs (post-developed), and an allowable  $q_o$  of 72 cfs (pre-developed), the value of  $(q_o)/(q_i)$  is 0.64
- Using figure 8.6, and a post-developed curve number of 78,  $V_s/V_r = 0.23$
- Using a total storm runoff volume of 427,155 cubic feet (9.8 acre-feet), the required storage ( $V_s$ ) is:

$$V_s = Q_{p_v} = 0.23(427,155)/43,560 = 2.26 \text{ acre-feet}$$

**Figure 8.6 Approximate Detention Basin Routing for Rainfall Types I, IA, II, and III**

Source: TR-55, 1986

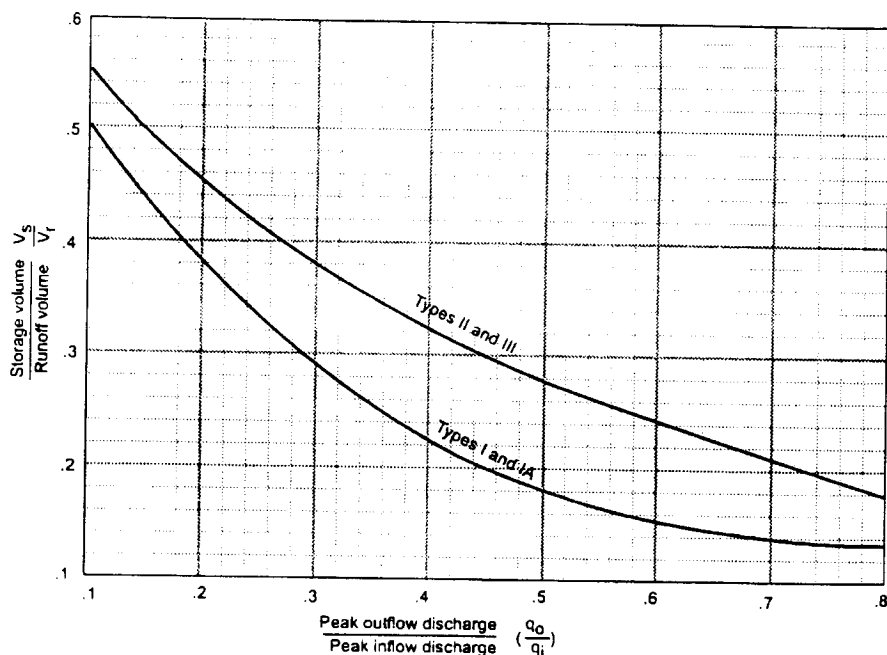

While the TR-55 short-cut method reports to incorporate multiple stage structures, experience has shown that an additional 10-15% storage is required when multiple levels of extended detention are provided inclusive with the 10-year storm. So, for preliminary sizing purposes, add 15% to the required volume for the 10-year storm.  $Q_{p-10} = 2.23 \times 1.15 = 2.59$  ac-ft.

#### Compute Extreme Flood Protection Volume, ( $Q_f$ )

Extreme flood protection is calculated using the same methodology as overbank protection.

- For a  $Q_{in}$  of, and an allowable  $Q_{out}$  of, and a runoff volume of the  $V_s$  necessary for 100-year control is, under a developed CN of 78. Note that 5.5 inches of rain fall during this event, with approximately 3.1 inches of runoff.
- While the TR-55 short-cut method reports to incorporate multiple stage structures, experience has shown that an additional 10-15% storage is required when multiple levels of extended detention are provided inclusive with the 100-year storm. So, for preliminary sizing purposes add 15% to the required volume for the 100-year storm.  $Q_{f-100} = 3.53 \times 1.15 = 4.06$  ac-ft.

**Analyze Safe Passage of 100-Year Design Storm (Qf)**

If peak discharge control of the 100-year storm is not required, it is still necessary to provide safe passage for the 100-year event under ultimate buildout conditions ( $Q_{ult} = 227$  cfs).

## Section 8.2 Pond Design Example

Following is a step-by-step design example for an extended detention pond (P-3) applied to Stone Hill Estates, which is described in detail in Section 8.1 along with design treatment volumes. This example continues with the design to develop actual design parameters for the constructed facility.

### Step 1. Compute preliminary runoff control volumes.

The volume requirements were determined in Section 8.1. Table 8.1 provides a summary of the storage requirements.

**Table 8.1. Summary of General Storage Requirements for Stone Hill Estates**

Symbol	Category	Volume Required (ac- ft)	Notes
WQ <sub>v</sub>	Water Quality Volume	1.07	
Cp <sub>v</sub>	Stream Protection	2.4	Average ED release rate is 1.2 cfs over 24 hours
Q <sub>p</sub>	Peak Control	2.6	10-year, in this case
Q <sub>f</sub>	Flood Control	4.1	

### Step 2. Determine if the development site and conditions are appropriate for the use of a stormwater pond.

The drainage area to the pond is 65.1 acres. Existing ground at the proposed pond outlet is 619 MSL. Soil boring observations reveal that the seasonally high water table is at elevation 618. The underlying soils are SC (sandy clay) and are suitable for earthen embankments and to support a wet pond without a liner. The stream invert at the adjacent stream is at elevation 616.

### Step 3. Confirm local design criteria and applicability.

There are no additional requirements for this site.



**Step 4. Determine pretreatment volume.**

Size wet forebay to treat 10% of the  $WQ_v$ .  $(10\%)(1.07 \text{ ac-ft}) = \mathbf{0.1 \text{ ac-ft}}$   
 (forebay volume is included in  $WQ_v$  as part of permanent pool volume)

**Step 5. Determine permanent pool volume and ED volume.**

Size permanent pool volume to contain 50% of  $WQ_v$ :

$0.5 \times (1.07 \text{ ac-ft}) = \mathbf{0.54 \text{ ac-ft}}$ . (includes 0.1 ac-ft of forebay volume)

Size ED volume to contain 50% of  $WQ_v$ :  $0.5 \times (1.07 \text{ ac-ft}) = \mathbf{0.54 \text{ ac-ft}}$

*NOTE*

*THIS DESIGN APPROACH ASSUMES THAT ALL OF THE ED VOLUME WILL BE IN THE POND AT ONCE. WHILE THIS WILL NOT BE THE CASE, SINCE THERE IS A DISCHARGE DURING THE EARLY STAGES OF STORMS, THIS CONSERVATIVE APPROACH ALLOWS FOR ED CONTROL OVER A WIDER RANGE OF STORMS, NOT JUST THE TARGET RAINFALL.*

**Step 6. Determine pond location and preliminary geometry. Conduct pond grading and determine storage available for  $WQ_v$  permanent pool and  $WQ_v$ -ED if applicable.**

This step involves initially grading the pond (establishing contours) and determining the elevation-storage relationship for the pond. Storage must be provided for the permanent pool (including sediment forebay), extended detention ( $WQ_v$ -ED),  $C_p$ -ED, 10-year storm, 100-year storm, plus sufficient additional storage to pass the ultimate condition 100-year storm with required freeboard. An elevation-storage table and curve is prepared using the average area method for computing volumes. See Figure 8.7 for pond location on site, Figure 8.8 for grading and Figure 8.9 for Elevation-Storage Data.

Figure 8.7 Pond Location on Site

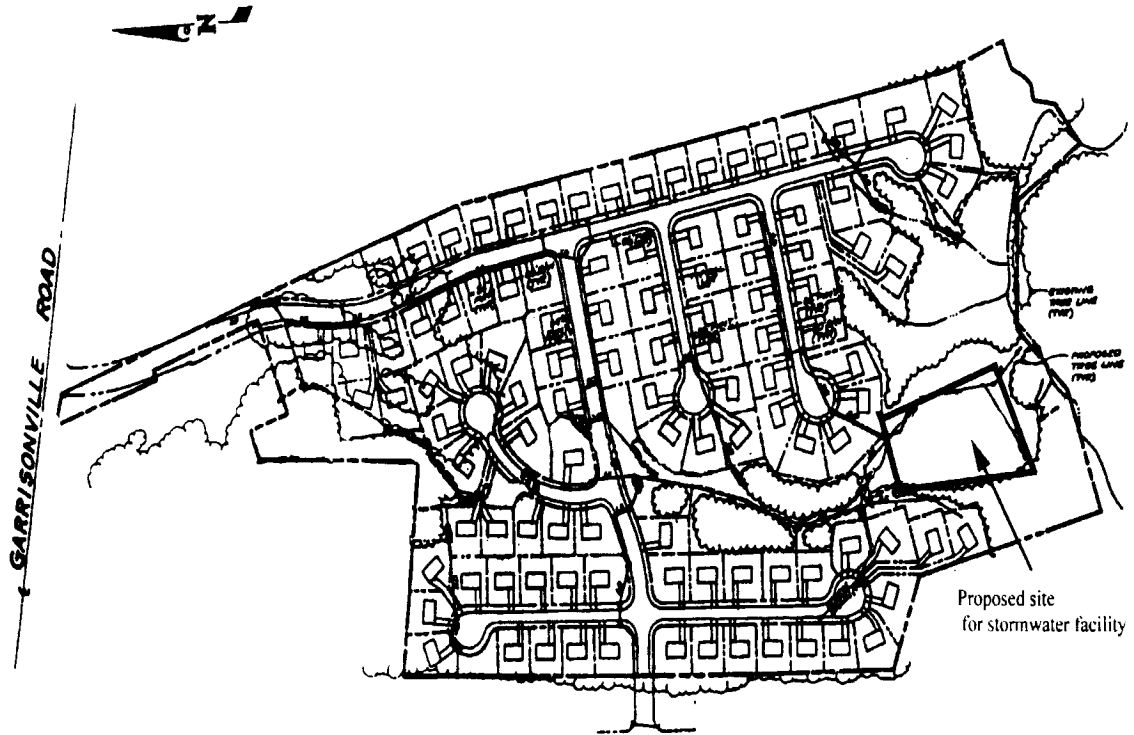

Figure 8.8 Plan View of Pond Grading (Not to Scale)

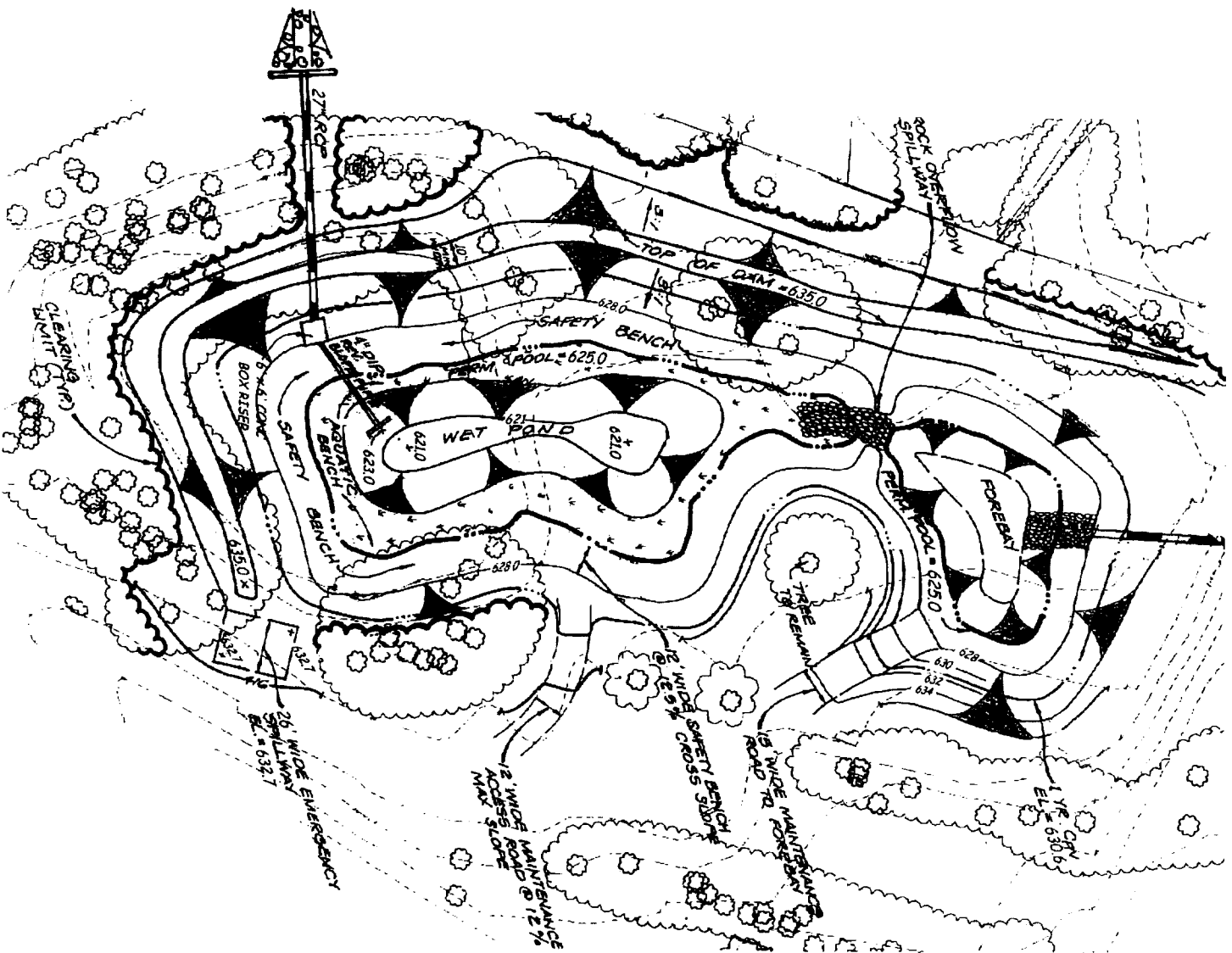
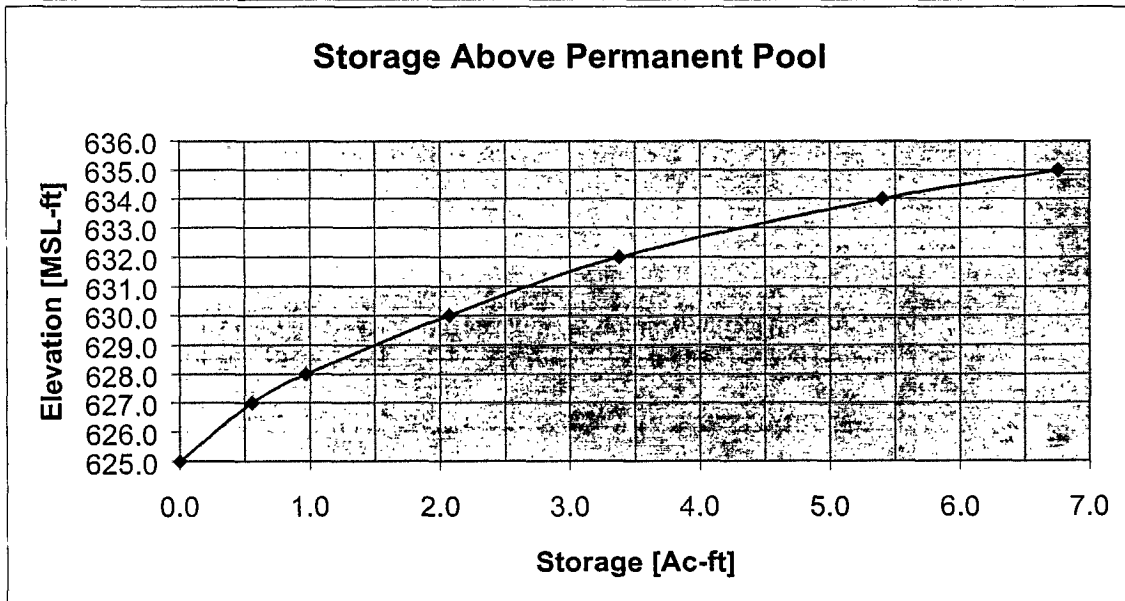

Figure 8.9 Storage-Elevation Table/Curve

Elevation MSL	Area ft <sup>2</sup>	Average Area ft <sup>2</sup>	Depth ft	Volume ft <sup>3</sup>	Cumulative Volume ft <sup>3</sup>	Cumulative Volume ac-ft	Volume Above Permanent Pool ac-ft
621.0	3150						
624.0	8325	5738	3	17213	17213	0.40	
625.0	10400	9363	1	9363	26575	0.61	0
627.0	13850	12125	2	24250	50825	1.17	0.56
628.0	21850	17850	1	17850	68675	1.58	0.97
630.0	26350	24100	2	48200	116875	2.68	2.07
632.0	30475	28413	2	56825	173700	3.99	3.38
634.0	57685	44080	2	88160	261860	6.01	5.40
635.0	60125	58905	1	58905	320765	7.36	6.75



Set basic elevations for pond structures

- The pond bottom is set at elevation 621.0
- Provide gravity flow to allow for pond drain, set riser invert at 620.5
- Set barrel outlet elevation at 620.0

Set water surface and other elevations

- Required permanent pool volume = 50% of  $WQ_v = 0.54$  ac-ft. From the elevation-storage table, read elevation 625.0 (0.61 ac-ft > 0.54 ac-ft) site can accommodate it and it allows a small safety factor for fine sediment accumulation – OK

Set permanent pool wsel = 625.0

- Forebay volume provided in single pool with volume = 0.1 ac-ft - OK
- Required extended detention volume ( $WQ_v$ -ED) = 0.54 ac-ft. From the elevation-storage table (volume above permanent pool), read elevation 627.0 (0.56 ac-ft > 0.54 ac-ft) OK. Set ED wsel = 627.0

*Note: Total storage at elevation 627.0 = 1.17 ac-ft (greater than required  $WQ_v$  of 1.07 ac-ft)*

Compute the required  $WQ_v$ -ED orifice diameter to release 0.54 ac-ft over 24 hours

- Avg. ED release rate =  $(0.54 \text{ ac-ft})(43,560 \text{ ft}^2/\text{ac}) / (24 \text{ hr})(3600 \text{ sec/hr}) = 0.27 \text{ cfs}$
- Invert of orifice set at wsel = 625.0
- Average head =  $(627.0 - 625.0) / 2 = 1.0'$
- Use orifice equation to compute cross-sectional area and diameter

$Q = CA(2gh)^{0.5}$ , for  $Q=0.27 \text{ cfs}$   $h = 1.0 \text{ ft}$ ;  $C = 0.6 =$  discharge coefficient. Solve for A

$A = 0.27 \text{ cfs} / [(0.6)((2)(32.2 \text{ ft/s}^2)(1.0 \text{ ft}))^{0.5}]$   $A = 0.057 \text{ ft}^2$ ,  $A = \pi d^2 / 4$ ;

dia. =  $0.26 \text{ ft} = 3.2''$ , say 3.0 inches

Use 4" pipe with 4" gate valve to achieve equivalent diameter

Compute the stage-discharge equation for the 3.0" dia.  $WQ_v$  orifice

•  $Q_{WQ_v\text{-ED}} = CA(2gh)^{0.5} = (0.6) (0.052 \text{ ft}^2) [((2)(32.2 \text{ ft/s}^2))^{0.5}] (h^{0.5})$ ,

•  $Q_{WQ_v\text{-ED}} = (0.25) h^{0.5}$ , where:  $h = \text{wsel} - 625.125$

*(Note: Account for one half of orifice diameter when calculating head)*

**Step 7. Compute ED orifice size, and compute release rate for Cp<sub>v</sub>-ED control and establish Cp<sub>v</sub> elevation.**

Set the Cp<sub>v</sub> pool elevation

- Required Cp<sub>v</sub> storage = 2.4 ac-ft (see Table 1).
- From the elevation-storage table, read elevation 630.6 (this includes the WQ<sub>v</sub>).
- Set Cp<sub>v</sub> wsel = 630.6

Size Cp<sub>v</sub> orifice

- Size to release average of 1.2 cfs.
- Set invert of orifice at wsel = 627.0
- Average WQ<sub>v</sub>-ED orifice release rate is 0.41 cfs, based on average head of 2.74'  $((630.6 - 625.125)/2)$
- Cp<sub>v</sub>-ED orifice release = 1.2 - 0.41 = 0.79 cfs
- Head =  $(630.6 - 627.0)/2 = 1.8'$

Use orifice equation to compute cross-sectional area and diameter

- $Q = CA(2gh)^{0.5}$ , for  $h = 1.8'$ 
  - $A = 0.79 \text{ cfs} / [(0.6)((2)(32.2'/s^2)(1.8'))^{0.5}]$
  - $A = 0.12 \text{ ft}^2$ ,  $A = \pi d^2 / 4$ ;
  - $\text{dia.} = 0.39 \text{ ft} = 4.7''$
  - Use 6" pipe with 6" gate valve to achieve equivalent diameter

Compute the stage-discharge equation for the 4.7" dia. Cp<sub>v</sub> orifice

- $Q_{\text{Cp}_v\text{-ED}} = CA(2gh)^{0.5} = (0.6) (0.12 \text{ ft}^2) [((2) (32.2'/s^2))^{0.5}] (h^{0.5})$ ,
- $Q_{\text{Cp}_v\text{-ED}} = (0.58) (h^{0.5})$ , where:  $h = \text{wsel} - 627.2$

*(Note: Account for one half of orifice diameter when calculating head)*

**Step 8. Calculate Q<sub>p10</sub> (10 year storm) release rate and water surface elevation.**

In order to calculate the 10 year release rate and water surface elevation, the designer must set up a stage-storage-discharge relationship for the control structure for each of the low flow release pipes (WQ<sub>v</sub>-ED and Cp<sub>v</sub>-ED) plus the 10 year storm.

## Develop basic data and information

- The 10 year pre-developed peak discharge = 72 cfs,
- The post developed inflow = 112 cfs, from Table 1,
- From previous estimate  $Q_{p-10} = 2.26$  ac-ft. Adding 15% to account for ED storage yields a preliminary volume of 2.56 ac-ft.
- From elevation-storage table (Figure 8.9), read elevation 631.0.
- Size 10 year slot to release 72 cfs at elevation 631.0.

@ wsel 631.0:

- $WQ_v$ -ED orifice releases 0.61 cfs,
- $Cp_v$ -ED orifice releases 1.13 cfs, therefore;
- Allowable  $Q_{p-10} = 72$  cfs - (.61 + 1.13) = 70.26 cfs, say 70.3 cfs.
- Set weir crest elevation at wsel = 630.6
- Max head = (631.0 - 630.6) = 0.4'

## Use weir equation to compute slot length

- $Q = CLh^{3/2}$
- $L = 70.3$  cfs / (3.1)  $(0.4^{3/2}) = 89.6$  ft
- This weir length is impractical, so adjust max head (and therefore slot height) to 1.5' and recalculate weir length.
- $L = 70.3$  cfs / (3.1)  $(1.5^{3/2}) = 12.3$  ft
- Use three 5ft x 1.5 ft slots for 10-year release (opening should be slightly larger than needed so as to have the barrel control before slot goes from weir flow to orifice flow).
- Maximum  $Q = (3.1)(15)(1.5)^{3/2} = 85.4$  cfs

## Check orifice equation using cross-sectional area of opening

- $Q = CA(2gh)^{0.5}$ , for  $h = 0.75'$  (For orifice equation, h is from midpoint of slot)
- $A = 3 (5.0') (1.5') = 22.5$  ft<sup>2</sup>
- $Q = 0.6 (22.5$  ft<sup>2</sup>)  $[(64.4)(0.75)]^{0.5} = 93.8$  cfs > 85.4 cfs, so use weir equation

$$Q_{10} = (3.1) (15') h^{3/2}, Q_{10} = (46.5) h^{3/2}, \text{ where } h = \text{wsel} - 630.6$$

- Size barrel to release approximately 70.3 cfs at elevation 632.1 (630.6 + 1.5)
- Check inlet condition: (use FHWA culvert charts)

$$H_w = 632.1 - 620.5 = 11.6 \text{ ft}$$

- Try 27" diameter RCP, Using FHWA Chart ("Headwater Depth for Concrete Pipe Culverts with Inlet Control") with entrance condition 1
- $H_w / D = 11.6/2.25 = 5.15$ , Discharge = 69 cfs
- Check outlet condition (use NRCS pipe flow equation from NEH Section 5 ES-42):
- $Q = a [(2gh)/(1+k_m+k_pL)]^{0.5}$

where:     $Q$  = discharge in cfs  
            $a$  = pipe cross sectional area in  $ft^2$   
            $g$  = acceleration of gravity in  $ft/sec^2$   
            $h$  = head differential (wsel - downstream centerline of pipe or tailwater elev.)  
            $k_m$  = coefficient of minor losses (use 1.0)  
            $k_p$  = pipe friction loss coef. ( $= 5087n^2/d^{4/3}$ ,  $d$  in inches,  $n$  is Manning's  $n$ )  
            $L$  = pipe length in ft

$$h = 632.1 - (620.0 + 1.125) = 10.98'$$

for 27" RCP, approximately 70 feet long:

$$Q = 4.0 [(64.4) (10.98) / (1+1+(0.0106) (70))]^{0.5} = 64.2 \text{ cfs}$$

64.2 cfs < 69 cfs, so barrel is outlet controlled and use outlet equation

$$Q = 19.4 (h)^{0.5}, \text{ where } h = \text{wsel} - 621.125$$

*Note: pipe will control flow before high stage inlet reaches max head.*

Complete stage-storage-discharge summary (Figure 8.10) up to preliminary 10-year wsel (632.1) and route 10 year post-developed condition inflow using computer software (e.g., TR-20). Pond routing computes 10-year wsel at 632.5 with discharge = 65.4 cfs < 72 cfs, OK (see Figure 8.11).



Figure 8.10 Stage-Storage-Discharge Summary

Elevation MSL	Storage ac-ft	Low Flow WQv-ED 3.0" eq dia		Riser						27" Barrel				Emergency Spillway 26' earthen 3:1		Total Discharge	
				Cpv-ED 4.7" eq. dia		High Stage Slot				Inlet		Pipe					
				H ft	Q cfs	H ft	Q cfs	H ft	Q cfs	H ft	Q cfs	H ft	Q cfs				H ft
625.0	0.00	0	0														0.00
625.5	0.14	0.4	0.15														0.15
626.0	0.28	0.9	0.23														0.23
626.5	0.42	1.4	0.29														0.29
627.0	0.56	1.9	0.34	0.0	0.00												0.34
627.5	0.77	2.4	0.39	0.3	0.32												0.70
628.0	0.97	2.9	0.42	0.8	0.52												0.94
629.0	1.52	3.9	0.49	1.8	0.78												1.27
629.5	1.80	4.4	0.52	2.3	0.88												1.40
630.0	2.07	4.9	0.55	2.8	0.97												1.52
630.6	2.40	5.5	0.58	3.4	1.07	-	-	0.0	0.0								1.65
631.0	2.73	5.9	0.61	3.8	1.13	-	-	0.4	11.8								13.5
632.1	3.45	7.0	0.66	4.9	1.28	0.75	94	1.5	85.4	11.6	69.0	11.0	64.2				64.2
632.5	3.80	7.4	0.68	5.3	1.34	0.95	106	-	-	12.0	70.0	11.4	65.4				65.4
632.7	4.10	7.6	0.69	5.5	1.36	1.05	111	-	-	12.2	71.0	11.6	66.0	0.0	0.0		66.0
633.3	4.70	-	-	-	-	-	-	-	-	12.8	72.0	12.2	67.6	0.6	26.0		93.6
634.0	5.40	-	-	-	-	-	-	-	-	13.5	73.0	12.9	69.6	1.3	95.0		164.6
635.0	6.75	-	-	-	-	-	-	-	-	14.5	86.0	13.9	72.2	2.3	251.0		323.2

Note: Adequate outfall protection must be provided in the form of a riprap channel, plunge pool, or combination to ensure non-erosive velocities.

**Step 9. Calculate  $Q_{p100}$  (100-year storm) release rate and water surface elevation, size emergency spillway, calculate 100-year water surface elevation.**

In order to calculate the 100-year release rate and water surface elevation, the designer must continue with the stage-storage-discharge relationship (Figure 8.10) for the control riser and emergency spillway.

Develop basic data and information

- The 100 year pre-developed peak discharge = 141 cfs,
- The post developed inflow = 202 cfs, from Table 1,
- From previous estimate  $Q_{p-100} = 3.53$  ac-ft. Adding 15% to account for ED storage yields a preliminary volume of 4.06 ac-ft.
- From elevation-storage table (Figure 8.10), read elevation 632.8, say 633.0.

The 10-year wsel is at 632.5. Set the emergency spillway at elevation at 632.7 (this allows for some additional storage above the 10-yr wsel) and use design information and criteria for Earth Spillways (not included in this manual).

- Size 100 year spillway to release 141 cfs at elevation 633.0.
- @ wsel 633.0:

- Outflow from riser structure is controlled by barrel (under outlet control), from Figure 8.11, read  $Q = 67.6$  cfs at  $w_{sel} = 633.3$ . Assume  $Q = 67$  cfs at  $w_{sel} = 633.0$ .
- Set spillway invert at  $w_{sel} = 632.7$
- Try 26' wide vegetated emergency spillway with 3:1 side slopes.
- Finalize stage-storage-discharge relationships and perform pond routing

Pond routing (TR-20) computes 100-year  $w_{sel}$  at 633.76 with discharge = 140.95 cfs < 141 cfs, OK (see Figure 8.11).

*Note: this process of sizing the emergency spillway and storage volume determination is usually iterative. This example reflects previous iterations at arriving at an acceptable design solution.*

**Step 10. Check for safe passage of  $Q_{p100}$  under ultimate buildout conditions and set top of embankment elevation.**

The safety design of the pond embankment requires that the 100-year discharge, based on ultimate buildout conditions be able to pass safely through the emergency spillway with sufficient freeboard (one foot). This criteria does not mean that the ultimate buildout peak discharge be attenuated to pre-development rates.

From previous hydrologic modeling we know that:

- The 100 year ultimate buildout peak discharge = 227 cfs,
- The ultimate buildout composite curve number is 82.

Using TR-20 or equivalent routing model, determine peak  $w_{sel}$ . Pond routing computes 100-year  $w_{sel}$  at 634.0 with discharge = 192 cfs (Figure 8.12).

Therefore, with one foot of freeboard, the minimum embankment elevation is 635.0. Table 8.2 provides a summary of the storage, stage, and discharge relationships determined for this design example. See Figure 8.13 for a schematic of the riser.

Table 8.2 Summary of Controls Provided					
Control Element	Type/Size of Control	Storage Provided	Elevation	Discharge	Remarks
Units		Acre-feet	MSL	cfs	
Permanent Pool		0.61	625.0	0	part of $WQ_v$
Forebay	submerged berm	0.1	625.0	0	included in permanent pool vol.
Extended Detention ( $WQ_v$ -ED)	4" pipe, sized to 3.0" equivalent diameter	0.56	627.0	0.25	part of $WQ_v$ , vol. above perm. pool, discharge is average release rate over 24 hours
Channel Protection ( $C_p$ -ED)	6" pipe sized to 4.7" equivalent diameter	2.4	630.6	1.2	volume above perm. pool, discharge is average release rate over 24 hours
Overbank Protection ( $Q_{p-10}$ )	Three 5' x 1.5' slots on a 6' x 6' riser, 30" barrel.	2.5	632.5	65.4	volume above perm. pool
Extreme Storm ( $Q_{f-100}$ )	26' wide earth spillway	4.0	633.8	140.9	volume above perm. pool
Extreme Storm Ultimate Buildout	26' wide earth spillway	NA	634	192.0	Set minimum embankment height at 635.0

Figure 8.11 TR-20 Model Input and Output

\*\*\*\*\*80-80 LIST OF INPUT DATA FOR TR-20 HYDROLOGY\*\*\*\*\*

```

JOB TR-20                FULLPRINT                NOPLOTS
TITLE   New York Manual Wet ED Example 1/01      EWB
TITLE   Post Developed Conditions Routing for 1, 10, and 100
3 STRUCT      1
8           625.0      0.0      0.0
8           625.5      0.15     0.14
8           626.0      0.23     0.28
8           626.5      0.29     0.42
8           627.0      0.34     0.56
8           627.5      0.70     0.77
8           628.0      0.94     0.97
8           629.0      1.27     1.52
8           629.5      1.40     1.80
8           630.0      1.52     2.07
8           630.6      1.65     2.40
8           631.0     13.50     2.73
8           632.1     64.20     3.45
8           632.7     66.00     4.10
8           633.3     93.60     4.70
8           634.0    165.0     5.40
8           635.0   35230     6.75
9 ENDTBL
6 RUNOFF 1      1      2 0.102      78.0      0.35      1 1      0 0 1
6 RESVOR 2      1 2      3 625.0      1 1      1
  ENDDATA
7 INCREM 6      0.1
7 COMPUT 7      1      1 0.0      2.3      1.0      2 2      1 01
  ENDCMP 1
7 COMPUT 7      1      1 0.0      3.9      1.0      2 2      1 10
  ENDCMP 1
7 COMPUT 7      1      1 0.0      5.5      1.0      2 2      1 99
  ENDCMP 1
  ENDJOB 2
    
```

\*\*\*\*\*END OF 80-80 LIST\*\*\*\*\*

TR20 XEQ 1/22/\*\*  
REV 09/01/83

New York Manual Wet ED Example 1/01 EWB  
Post Developed Conditions Routing for 1, 10, and 100

JOB 1 SUMMARY  
PAGE 8

SUMMARY TABLE 1 - SELECTED RESULTS OF STANDARD AND EXECUTIVE CONTROL INSTRUCTIONS IN THE ORDER PERFORMED  
A STAR(\*) AFTER THE PEAK DISCHARGE TIME AND RATE (CFS) VALUES INDICATES A FLAT TOP HYDROGRAPH  
A QUESTION MARK(?) INDICATES A HYDROGRAPH WITH PEAK AS LAST POINT.)

SECTION/ STRUCTURE ID	STANDARD CONTROL OPERATION	DRAINAGE AREA (SQ MI)	RAIN TABLE #	ANTEC MOIST COND	MAIN TIME INCREM (HR)	PRECIPITATION			RUNOFF AMOUNT (IN)	PEAK DISCHARGE			
						BEGIN (HR)	AMOUNT (IN)	DURATION (HR)		ELEVATION (FT)	TIME (HR)	RATE (CFS)	RATE CSM
ALTERNATE 1 STORM 1													
STRUCTURE 1	RUNOFF	.10	2	2	.10	.0	2.30	24.00	.66	---	12.13	40.62	398.2
STRUCTURE 1	RESVOR	.10	2	2	.10	.0	2.30	24.00	.40	630.31	18.00?	1.59?	15.6
ALTERNATE 1 STORM 10													
STRUCTURE 1	RUNOFF	.10	2	2	.10	.0	3.90	24.00	1.81	---	12.11	118.47	161.5
STRUCTURE 1	RESVOR	.10	2	2	.10	.0	3.90	24.00	1.49	632.51	12.34	65.43	41.5
ALTERNATE 1 STORM 99													
STRUCTURE 1	RUNOFF	.10	2	2	.10	.0	5.50	24.00	3.14	---	12.11	206.59	025.4
STRUCTURE 1	RESVOR	.10	2	2	.10	.0	5.50	24.00	2.80	633.76	12.29	140.95	381.9

**Figure 8.12 TR-20 Model Input and Output for Ultimate Buildout Conditions**

TR20 XEQ 1/22/\*\*                      New York Manual Wet ED Example 1/01                      EMB                      JOB 1      SUMMARY  
 REV 09/01/83                      Ultimate Buildout Conditions for 100-yr                                                                PAGE 4

SUMMARY TABLE 1 - SELECTED RESULTS OF STANDARD AND EXECUTIVE CONTROL INSTRUCTIONS IN THE ORDER PERFORMED  
 (A STAR(\*) AFTER THE PEAK DISCHARGE TIME AND RATE (CFS) VALUES INDICATES A FLAT TOP HYDROGRAPH  
 A QUESTION MARK(?) INDICATES A HYDROGRAPH WITH PEAK AS LAST POINT.)

SECTION/ STRUCTURE ID	STANDARD CONTROL OPERATION	DRAINAGE AREA (SQ MI)	RAIN TABLE #	ANTEC MOIST COND	MAIN INCREM TIME (HR)	PRECIPITATION			RUNOFF AMOUNT (IN)	PEAK DISCHARGE			
						BEGIN (HR)	AMOUNT (IN)	DURATION (HR)		ELEVATION (FT)	TIME (HR)	RATE (CFS)	RATE (CSM)
ALTERNATE	1	STORM	99										
STRUCTURE 1	RUNOFF	.10	2	2	.10	.0	5.50	24.00	3.53	---	12.10	230.71	2261.9
STRUCTURE 1	RESVOR	.10	2	2	.10	.0	5.50	24.00	3.19	634.00	12.22	191.83	1880.7

Figure 8.13 Profile of Principle Spillway

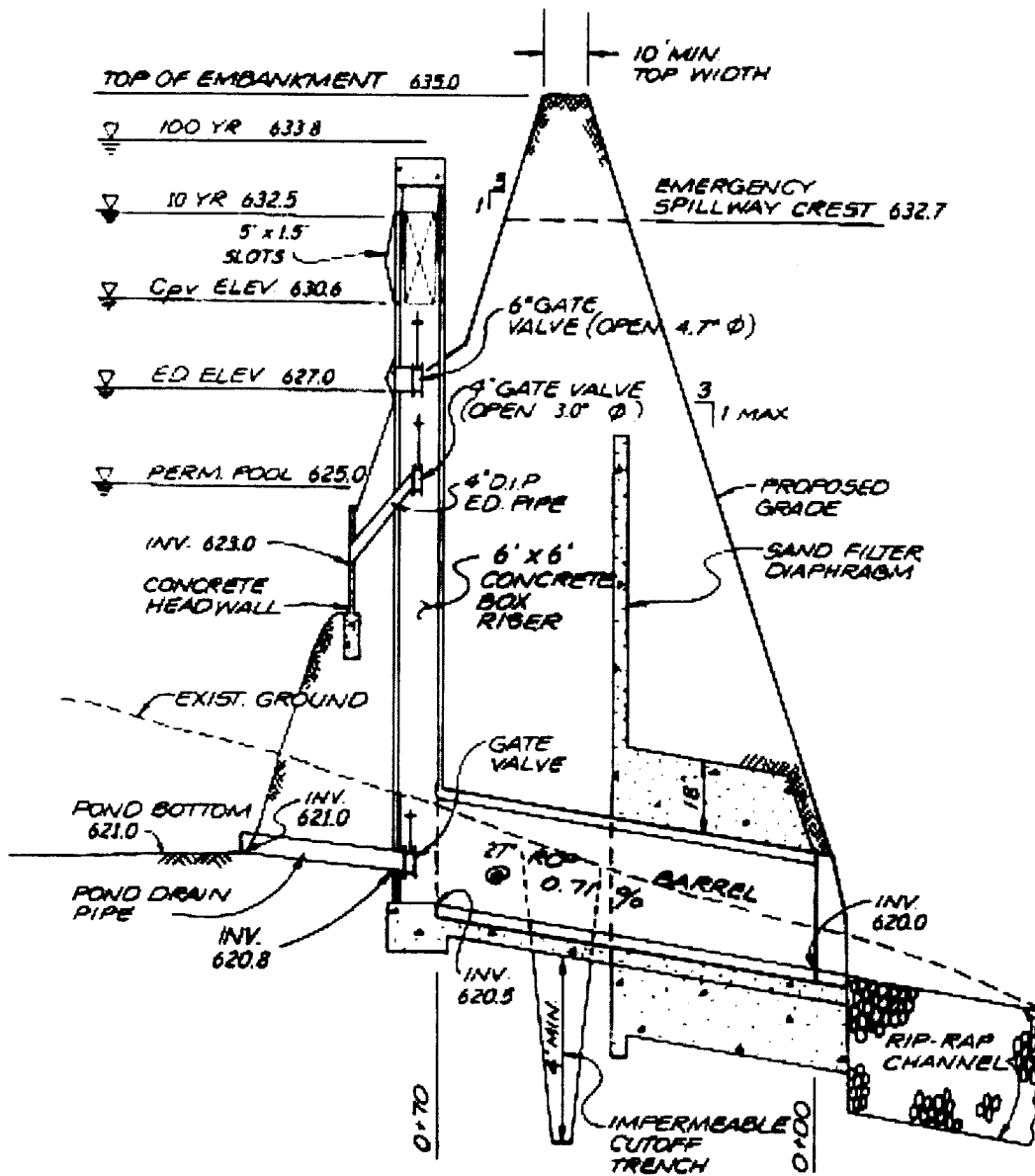

**Section 8.3 Sand Filter Design Example**

This design example focuses on the design of a sand filter for a 4.5-acre catchment of Lake Center, a hypothetical commercial site located in Albany, NY. A five-story office building and associated parking are proposed within the catchment. The layout is shown in Figure 8.14. The catchment has 3.05 acres of impervious cover, resulting in 68% impervious cover. The pre-developed site is a mixture of forest and meadow. On-site soils are predominantly HSG “B” soils.

Figure 8.14 Lake Center Site Plan

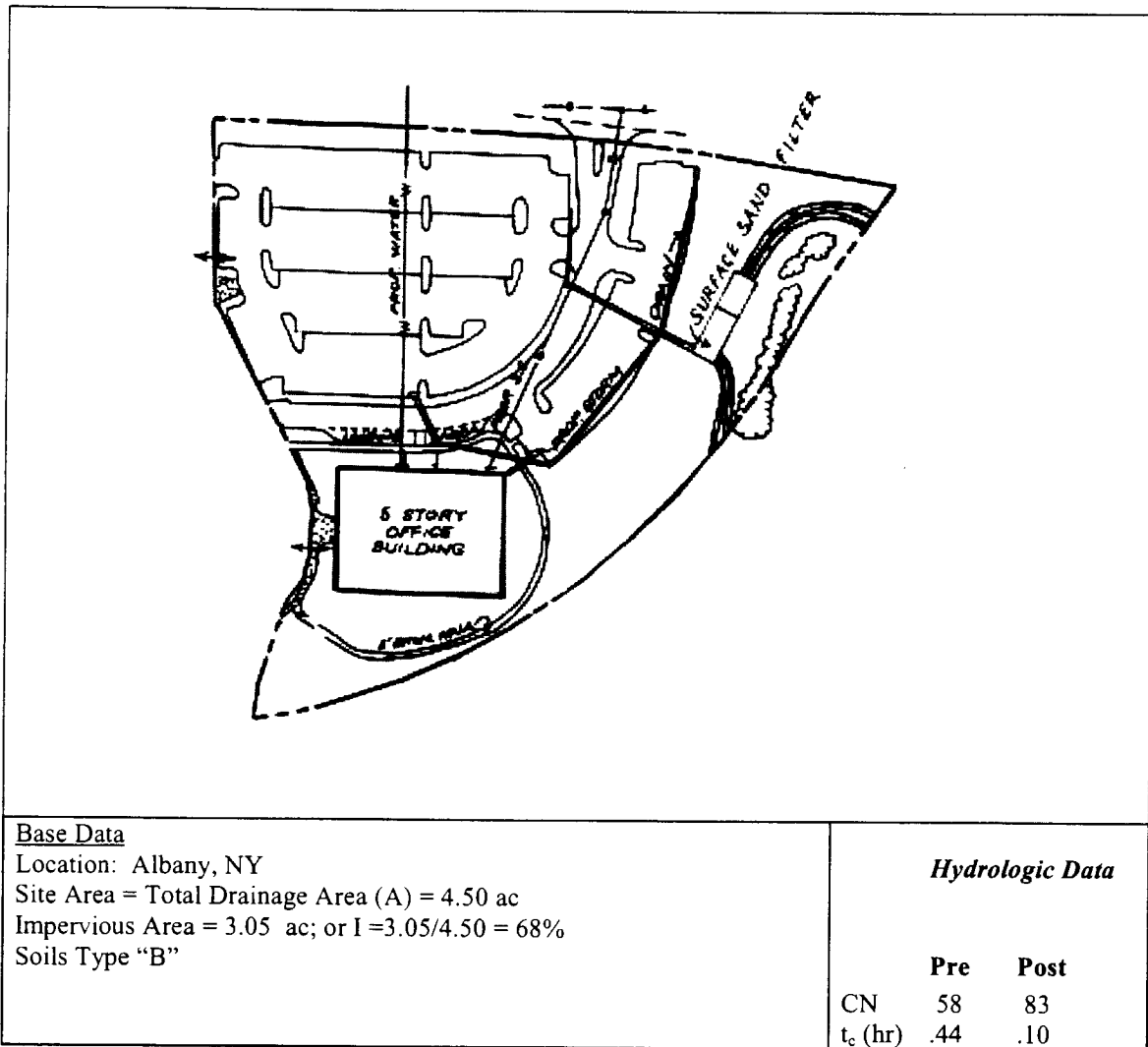



This step-by-step example will focus on meeting the water quality requirements. Channel protection control, overbank flood control, and extreme flood control are not addressed in this example. Therefore, a detailed hydrologic analysis is not presented. For an example of detailed sizing calculations, consult section 8.1. In general, the primary function of sand filters is to provide water quality treatment and not large storm attenuation. As such, flows in excess of the water quality volume are typically routed to bypass the facility. For this example, the post-development 10-yr peak discharge is provided to appropriately size the necessary by-pass flow splitter. Where quantity control is required, bypassed flows can be routed to conventional detention basins (or some other facility such as underground storage vaults).

**Step 1. Compute design volumes using the Unified Stormwater Sizing Criteria.**

**Water Quality Volume,  $WQ_v$**

*Select the Design Storm*

Consulting Figure 4.1 of this document, use 1.0" as the 90% rainfall event for Albany.

Compute Runoff Coefficient,  $R_v$

$$R_v = 0.05 + (68)(0.009) = 0.66$$

Compute  $WQ_v$

$$\begin{aligned} WQ_v &= (1.0'') (R_v) (A) / 12 \\ &= (1.0'') (0.66) (4.5 \text{ ac}) (43,560 \text{ ft}^2/\text{ac}) (1 \text{ ft}/12 \text{ in}) \\ &= \underline{10,781 \text{ ft}^3} = \underline{0.25 \text{ ac-ft}} \end{aligned}$$

**Develop Site Hydrologic Input Parameters and Perform Preliminary Hydrologic Calculations (see Table 8.3)**

*Note: For this design example, the 10-year peak discharge is given and will be used to size the bypass flow splitter. Any hydrologic models using SCS procedures, such as TR-20, HEC-HMS, or HEC-1, can be used to perform preliminary hydrologic calculations.*

Table 8.3 Site Hydrology					
Condition	CN	Q <sub>1</sub>	Q <sub>2</sub>	Q <sub>10</sub>	Q <sub>100</sub>
		<i>cfs</i>	<i>cfs</i>	<i>cfs</i>	<i>cfs</i>
Pre-developed	58	0.2	0.4	3	9
Post-Developed	83	7	10	19	36

**Step 2. Determine if the development site and conditions are appropriate for the use of a surface sand filter.**

**Site Specific Data:**

Existing ground elevation at practice location is 222.0 feet, mean sea level. Soil boring observations reveal that the seasonally high water table is at 211.0 feet. Adjacent drainage channel invert is at 213.0 feet.

**Step 3. Compute available head, & peak discharge (Q<sub>wq</sub>).**

- Determine available head (See Figure 8.15)

The low point at the parking lot is 223.5. Subtract 2' to pass the Q<sub>10</sub> discharge (221.5) and a half foot for the inflow channel to the facility (221.0). The low point at the channel invert is 213.0. Set the outfall underdrain pipe 1.0' above the drainage channel invert and add 0.5' to this value for the drain slope (214.5). Add to this value 8" for the gravel blanket over the underdrains, and 18" for the sand bed (216.67). The total available head is 221.0 - 216.67 or 4.33 feet. Therefore, the available average depth ( $h_f$ ) =  $4.33' / 2 = 2.17'$ .

Figure 8.15 Available Head Diagram

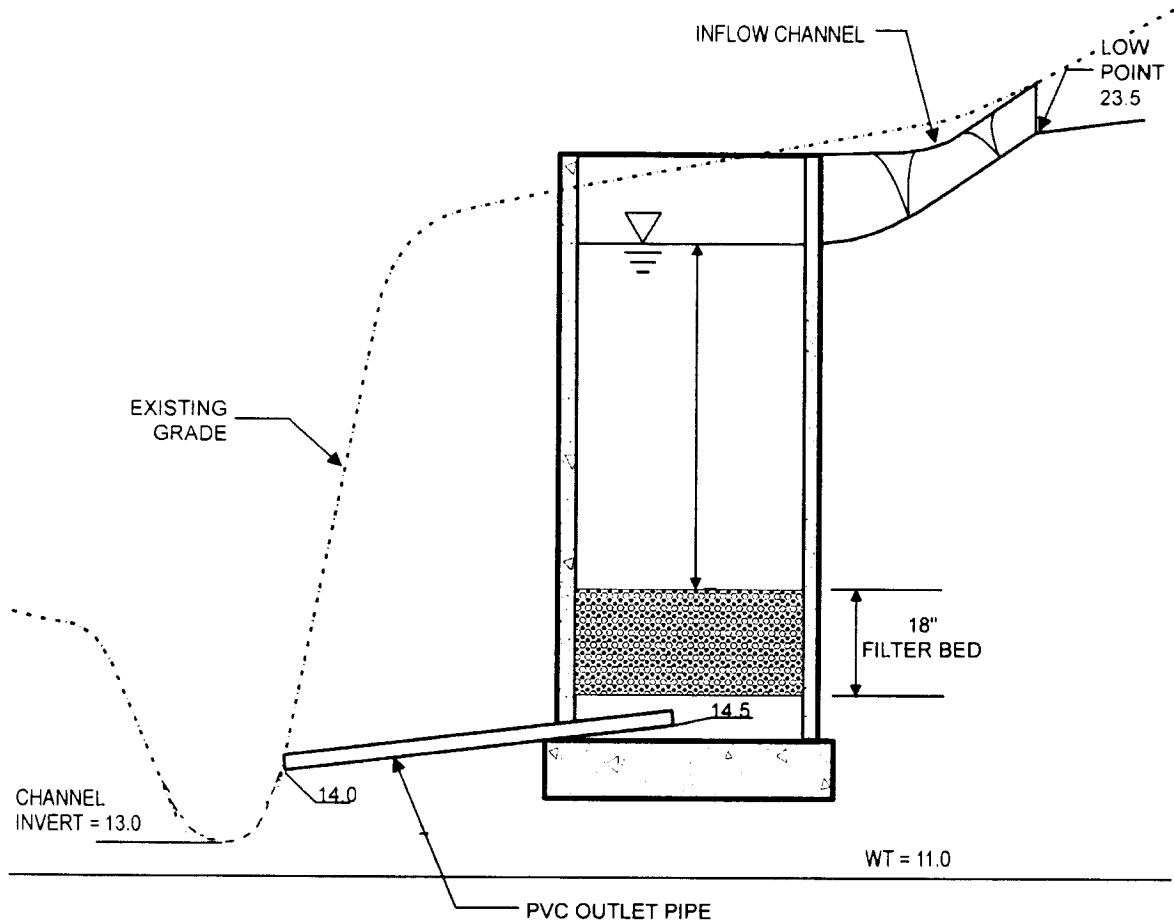

- Compute Peak Water Quality Discharge:

The peak rate of discharge for the water quality design storm is needed for the sizing of off-line diversion structures, such as sand filters and grass channels. The Small Storm Hydrology Method presented in Appendix B was followed to calculate a modified curve number and subsequent peak discharge associated with the 1.0-inch rainfall. Calculation steps are provided below.

Compute modified CN for 1.0" rainfall

$$P = 1.0''$$

$$Q_a = WQ_v \div \text{area} = (10,781 \text{ ft}^3 \div 4.5 \text{ ac} \div 43,560 \text{ ft}^2/\text{ac} \times 12 \text{ in/ft}) = 0.66''$$

$$CN = 1000 / [10 + 5P + 10Q_a - 10(Q_a^2 + 1.25 * Q_a * P)^{1/2}]$$

$$= 1000/[10+5*1.0+10*0.66-10(0.66^2+1.25*0.66*1.0)^{1/2}]$$

$$= 96.4$$

Use CN = 96

For CN = 96 and the  $t_c = 0.1$  hours, compute the  $Q_{wq}$  for a 1.0" storm. With the CN = 96, a 1.0" storm will produce 0.6" of runoff. From TR-55 Chapter 2, Hydrology,  $I_a = 0.083$ , therefore:

$$I_a/P = 0.083/1.0 = 0.083.$$

From TR-55 Chapter 4  $q_u = 1000$  csm/in, and

$$Q_{wq} = (1000 \text{ csm/in}) (4.5 \text{ ac}/640\text{ac/sq mi.}) (0.66") = \underline{4.6 \text{ cfs.}}$$

#### **Step 4. Size the flow diversion structure.**

Assume that flows are diverted to a diversion structure (Figure 8.16). First, size a low-flow orifice to pass the water quality storm ( $Q_p = 4.6$  cfs).

$$Q = CA(2gh)^{1/2}; 4.6 \text{ cfs} = (0.6) (A) [(2) (32.2 \text{ ft/s}^2) (1.5')]^{1/2}$$

$$A = 0.77 \text{ sq ft} = \pi d^2/4; d = 0.99' \text{ or } \underline{12"}$$

Size the 10-year overflow as follows:

The 10-year wsel is initially set at 223.0. Use a concrete weir to pass the 10-year flow (19.0 cfs), minus the flow carried by the low flow orifice, into a grassed overflow channel using the Weir equation. Assume 2' of head to pass this event. Overflow channel should be designed to provide sufficient energy dissipation (e.g., riprap, plunge pool, etc.) so that there will be non-erosive velocities.

Determine the flow from the low-flow orifice ( $Q_{lf}$ ). Assume 3.5' of head (1.5' plus 2' for the 10-year head):

$$Q_{lf} = (0.6) (A) [(2) (32.2 \text{ ft/s}^2) (3.5')]^{1/2}$$

$$A = \pi (1')^2/4$$

$$= 0.78 \text{ sf}$$

So,

$$Q_{tr} = (0.6) (0.78) [(2) (32.2 \text{ ft/s}^2) (3.5') ]^{1/2}$$

$$= 7.0 \text{ cfs}$$

Thus, determine the flow passed to the through the channel as:

$$Q = CLH^{3/2}$$

$$(19-7) = 3.1 (L) (2')^{1.5}$$

L = 1.4' which sets the minimum length of the flow diversion overflow weir.

Weir wall elev. = 21.0. Set low flow invert at  $21.0 - [1.5' + (0.5 * 12" * 1 \text{ft}/12")]$  = 19.00.

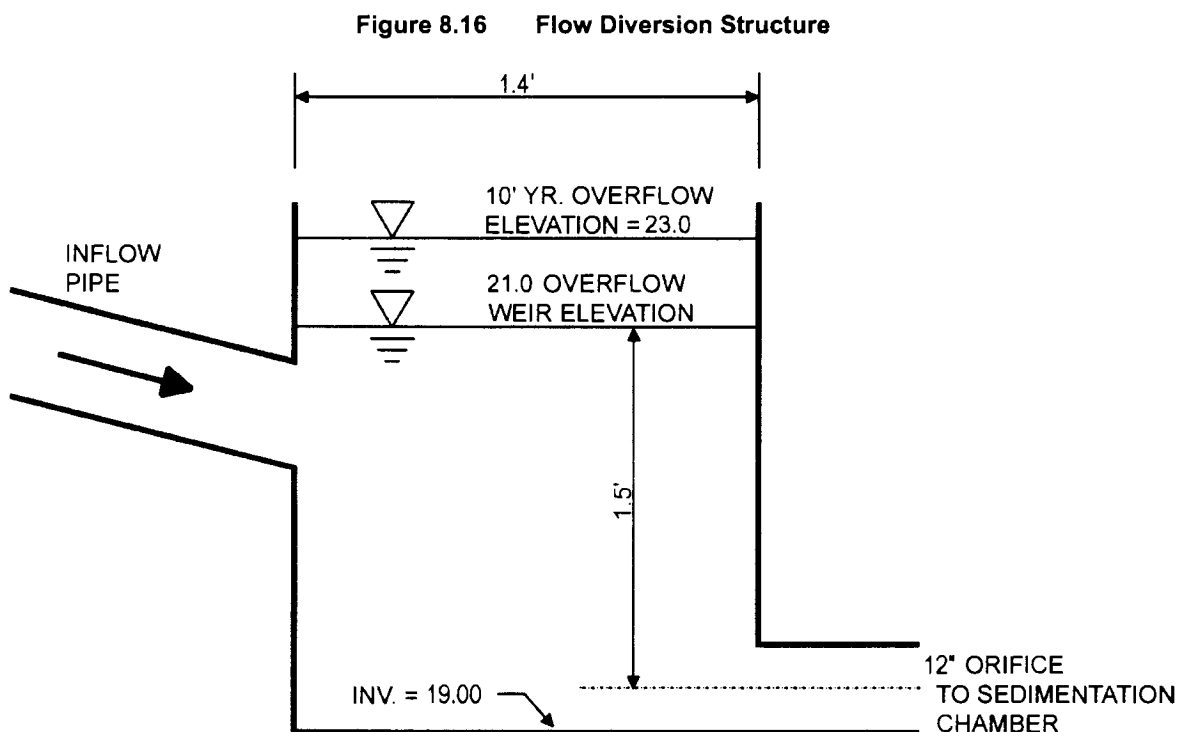

**Step 5. Size filtration bed chamber (see Figure 8.17).**

From Darcy's Law:  $A_f = WQ_v (d_f) / [k (h_f + d_f) (t_f)]$

where  $d_f = 18"$  or  $1.5'$  (Filter thickness)

$k = 3.5 \text{ ft/day}$  (Flow-through rate)

$h_f = 2.17'$  (Average head on filter)

$t_f = 40 \text{ hours}$  (Drain time)

$$A_f = (10,781 \text{ cubic feet}) (1.5') / [3.5 (2.17' + 1.5') (40\text{hr}/24\text{hr}/\text{day})]$$

$$A_f = \underline{755 \text{ sq ft}}; \text{ filter is } \underline{20' \text{ by } 40'} (= 800 \text{ sq ft})$$

#### Step 6. Size sedimentation chamber.

Size the sedimentation chamber as wet storage with a 2.5' depth. Determine the pretreatment volume as:

$$\begin{aligned} P_v &= (0.25) (10,781 \text{ cf}) \\ &= 2,695 \text{ cf} \end{aligned}$$

Therefore,

$$\begin{aligned} A_s &= (2,695 \text{ cf}) / (2.5') \\ &= 1,078 \text{ sf} \quad (\text{Use } 20' \times 55' \text{ or } 1,100 \text{ sf}) \end{aligned}$$

#### Step 7. Compute $V_{\min}$ .

$$V_{\min} = \frac{1}{4}(WQ_v) \text{ or } 0.75 (10,781 \text{ cubic feet}) = \underline{8,086 \text{ cubic feet}}$$

#### Step 8. Compute volume within practice.

Volume within filter bed ( $V_f$ ):  $V_f = A_f (d_f) (n)$ ;  $n = 0.4$  for sand

$$V_f = (800 \text{ sq ft}) (1.5') (0.4) = \underline{480 \text{ cf}}$$

temporary storage above filter bed ( $V_{f\text{-temp}}$ ):  $V_{f\text{-temp}} = 2h_f A_f$

$$V_{f\text{-temp}} = 2 (2.17') (800 \text{ sq ft}) = \underline{3,472 \text{ cf}}$$

Compute storage in the sedimentation chamber ( $V_s$ ):

$$V_s = (2.5')(1,100 \text{ sf}) + 4.33'(1,100 \text{ sf}) = 7,513 \text{ cf}$$

$$V_f + V_{f\text{-temp}} + V_s = 480 \text{ cf} + 3,472 \text{ cf} + 7,513 \text{ cf} = 11,465 \text{ cf}$$

$$11,465 > 8,086 \quad \text{OK.}$$

Pass flow through to the distribution chamber using a 12" orifice with an inverted elbow (see Figure 8.17).

**Step 9. Compute sedimentation chamber and filter bed overflow weir sizes.**

Assume overflow that needs to be handled is equivalent to the 12" orifice discharge under a head of 3.5 ft (i.e., the head in the diversion chamber associated with the 10-year peak discharge).

$$Q = CA(2gh)^{1/2}$$

$$Q = 0.6(0.79 \text{ ft}^2)[(2)(32.2 \text{ ft/s}^2)(3.5 \text{ ft})]^{1/2}$$

$$Q = 7.1 \text{ cfs}$$

Size the overflow weir from the sediment chamber and the filtration chamber to pass 7.1 cfs (this assumes no attenuation within the practice).

Weir equation:  $Q = CLh^{3/2}$ , assume a maximum allowable head of 0.5'

$$7.1 = 3.1 * L * (0.5 \text{ ft})^{3/2}$$

$$\underline{L = 6.5 \text{ ft.}}$$

Adequate outlet protection and energy dissipation (e.g., riprap, plunge pool, etc.) should be provided for the downstream overflow channel.

**Figure 8.17 Plan and Profile of Surface Sand Filter**

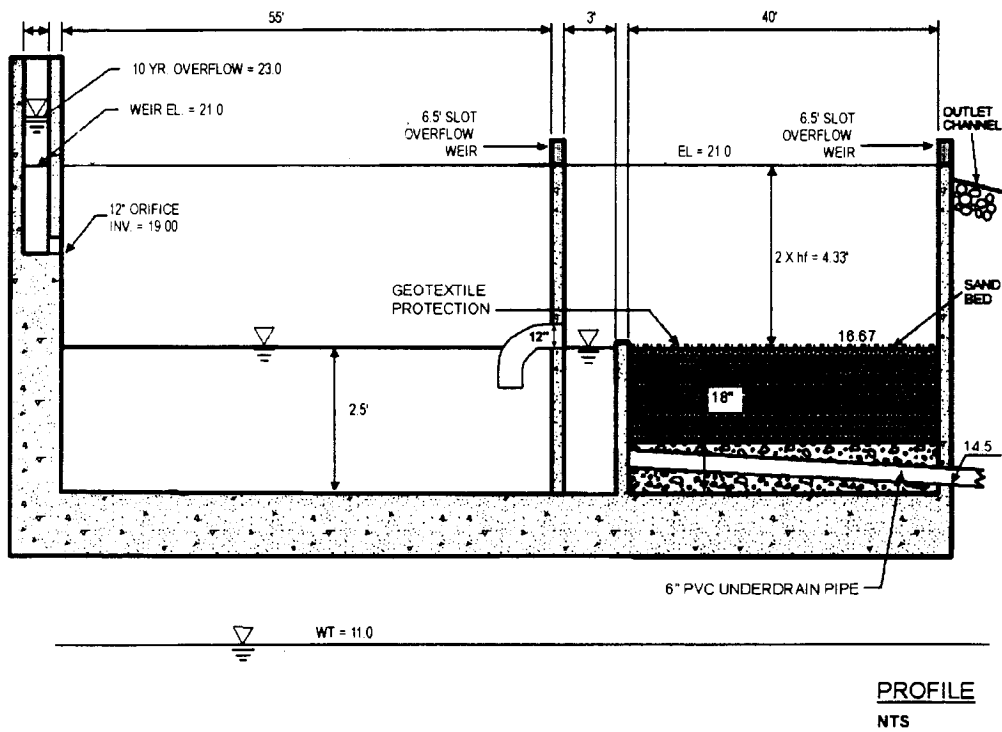
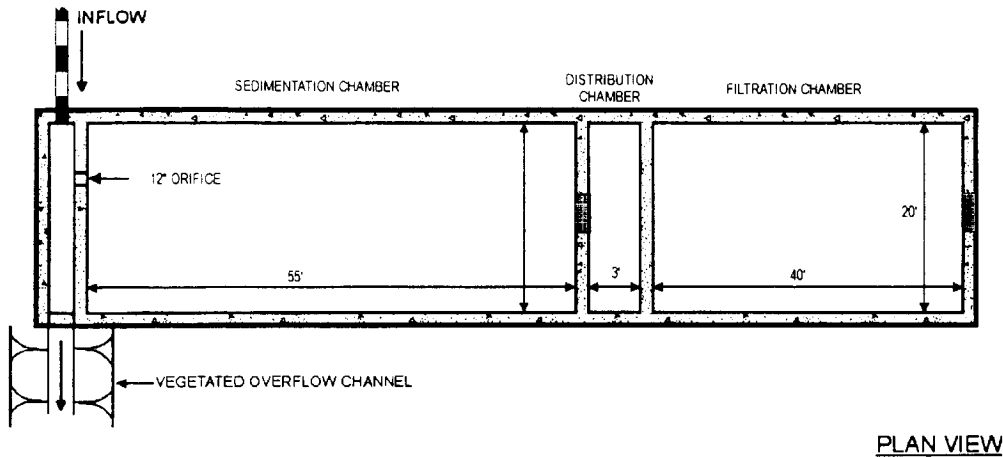



**Section 8.4 Infiltration Trench Design Example**

This design example focuses on the design of an infiltration trench for a 4.5-acre catchment of the Lake Center, a hypothetical commercial site located in Albany, NY. A five-story office building and associated parking are proposed within this catchment. The layout is shown in Figure 8.18. The catchment has 3.05 acres of impervious cover, resulting in a site impervious cover of 68%. The pre-developed site is a mixture of forest and meadow. On-site soils are predominantly HSG “B” soils.

**Figure 8.18 Lake Center Site Plan**

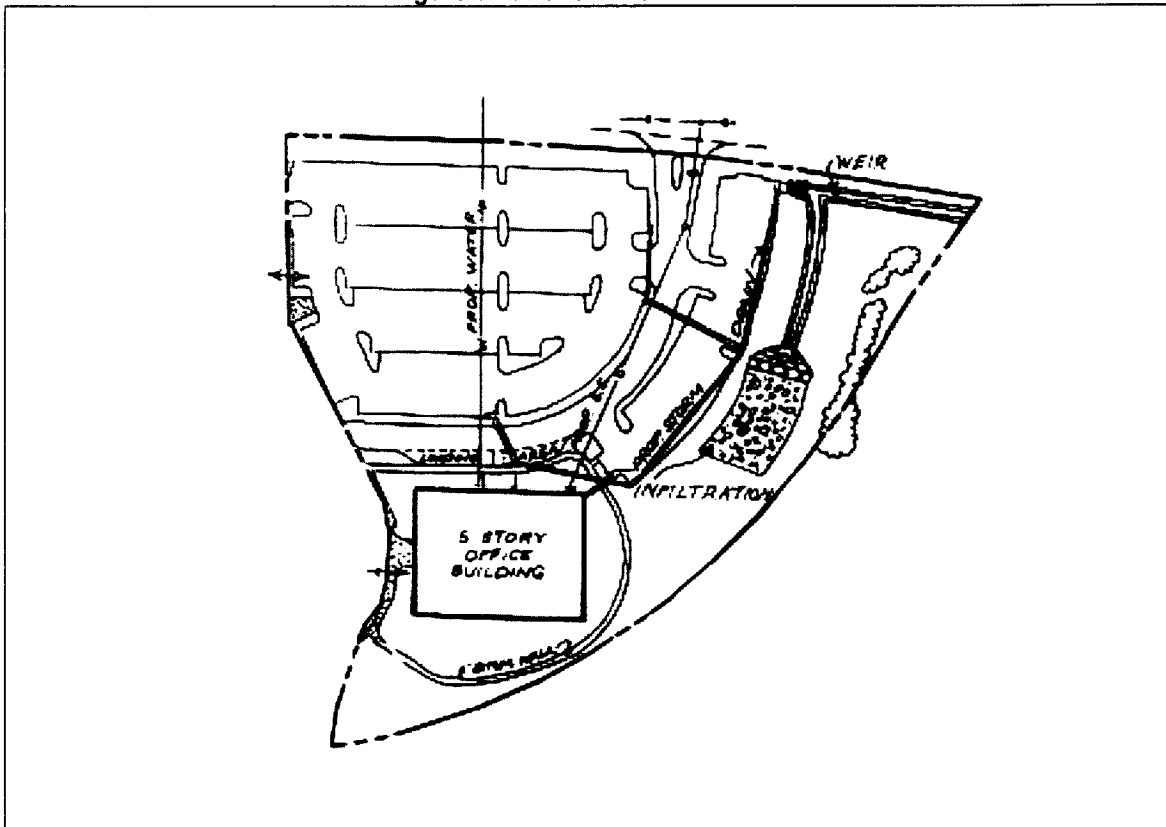

<p><u>Base Data</u>                  Location: Albany, NY                  Site Area = Total Drainage Area (A) = 4.5 ac                  Impervious Area = 3.05 ac; or <math>I = 3.05/4.50 = 68\%</math>                  Soils Type “B”</p>	<p><i>Hydrologic Data</i></p> <table border="1"> <thead> <tr> <th></th> <th>Pre</th> <th>Post</th> </tr> </thead> <tbody> <tr> <td>CN</td> <td>58</td> <td>83</td> </tr> <tr> <td><math>t_c</math> (hrs)</td> <td>.44</td> <td>.10</td> </tr> </tbody> </table>		Pre	Post	CN	58	83	$t_c$ (hrs)	.44	.10
	Pre	Post								
CN	58	83								
$t_c$ (hrs)	.44	.10								

This step-by-step example will focus on meeting the water quality requirements. Channel protection control, overbank flood control, and extreme flood control are not addressed in this example. Therefore, a detailed hydrologic analysis is not presented. For an example of detailed sizing calculations, consult section 8.1. In general, the primary function of infiltration practices is to provide water quality treatment and not large storm attenuation. As such, flows in excess of the water quality volume are typically routed to bypass the facility. For this example, the post-development 10-yr peak discharge is provided to appropriately size the necessary by-pass flow splitter. Where quantity control is required, bypassed flows can be routed to conventional detention basins (or some other facility such as underground storage vaults).

**Step 1. Compute design volumes and flows using the Unified Stormwater Sizing Criteria.**

Design values are presented in Table 8.4 below.

Table 8.4 Site Design Hydrology					
Condition	CN	WQ <sub>v</sub>	Q <sub>1</sub>	Q <sub>2</sub>	Q <sub>10</sub>
		<i>ft<sup>3</sup></i>	<i>cfs</i>	<i>cfs</i>	<i>cfs</i>
Pre-Developed	58		0.2	0.4	3
Post-Developed	83	10,781	7	10	19

**Step 2. Determine if the development site and conditions are appropriate for the use of an infiltration trench.**

**Site Specific Data:**

Table 8.5 presents site-specific data, such as soil type, percolation rate, and slope, for consideration in the design of the infiltration trench. See Appendix D for infiltration testing requirements and Appendix C for infiltration practice construction specifications.

Table 8.5 Site Specific Data	
Criteria	Value
Soil	Silt Loam
Percolation Rate	0.5"/hour
Ground Elevation at BMP	219'
Seasonally High Water Table	211'
Local Ground Slope	<1%

**Step 3. Confirm local design criteria and applicability.**

Table 8.6, below, summarizes the requirements that need to be met to successfully implement infiltration practices. On this site, infiltration is feasible, with restrictions on the depth and width of the trench.

Table 8.6 Infiltration Feasibility	
Criteria	Status
Infiltration rate ( $f_c$ ) greater than or equal to 0.5 inches/hour.	<ul style="list-style-type: none"> <li>Infiltration rate is 0.5 inches/hour. OK.</li> </ul>
Soils have a clay content of less than 20% and a silt/clay content of less than 40%.	<ul style="list-style-type: none"> <li>Silt Loam meets both criteria.</li> </ul>
Infiltration cannot be located on slopes greater than 6% or in fill soils.	<ul style="list-style-type: none"> <li>Slope is &lt;1%; not fill soils. OK.</li> </ul>
Hotspot runoff should not be infiltrated.	<ul style="list-style-type: none"> <li>Not a hotspot land use. OK.</li> </ul>
The bottom of the infiltration facility must be separated by at least two feet vertically from the seasonally high water table.	<ul style="list-style-type: none"> <li>Elevation of seasonally high water table: 11'</li> <li>Elevation of BMP location: 19'.</li> <li>The difference is 8'.</li> <li>Thus, the trench can be up to 5' deep. OK.</li> </ul>
Infiltration facilities must be located 100 feet horizontally from any water supply well.	<ul style="list-style-type: none"> <li>No water supply wells nearby. OK.</li> </ul>
Maximum contributing area generally less than 5 acres.	<ul style="list-style-type: none"> <li>Area draining to facility is approximately 4.5 acres.</li> </ul>
Setback 25 feet down-gradient from structures.	<ul style="list-style-type: none"> <li>Trench edge is &gt; 25' from all structures. OK.</li> </ul>

#### Step 4. Size overflow channel.

Water flows from the edge of the parking lot to a 4' wide, flat bottom channel with 3:1 side slopes and a 2% slope. This channel also provides pretreatment (See Step 6). Use a weir to divert the water quality volume to the infiltration trench, while allowing the 10-year event to an adjacent drainage channel and the water quality storm to flow to the infiltration trench. The peak flow for the water quality storm is 4.6 cfs (see Section 8.3 for an example calculation).

Determine the depth of flow for the water quality storm using Manning's equation. (Several software packages can be used). The following assumptions are made:

Trapezoidal channel with 3:1 side slopes

4' bottom width.

$S = 1\%$

$n$  varies between 0.03 at 1' depth to 0.15 at 4" depth (See Appendix L and Grass Channel Fact Sheet in Chapter 5).

Determine that the water quality storm passes at  $d = 0.64'$ .

Size a weir to pass the 10-year peak event, less the water quality peak flow, so that:

$$Q = 19\text{cfs} - 4.6\text{ cfs} = 14.4\text{ cfs.}$$

Use a weir length,  $L$ , of 4.0'.

By rearranging the weir equation:

$$H = (Q/CL)^{2/3} = (14.4/3.1(4))^{2/3} = 1.1'$$

Size the channel to pass the 10-year event with 6" of freeboard.

#### Step 5. Size the infiltration trench.

The area of the trench can be determined by the following equation:

$$A = WQv/(nd)$$

Where:

- A = Surface Area  
 WQ<sub>v</sub> = Water Quality volume (ft<sup>3</sup>)  
 n = Porosity  
 d = Trench depth (feet)

Assume that:

- n = 0.4  
 d = 4 feet

Therefore:

- A = 10,781 ft<sup>3</sup> / (0.4 × 4)ft  
 A = 6,738ft<sup>2</sup>

The proposed location for the infiltration trench will accommodate a trench width of up to 65 feet.

Therefore, the minimum length required would be:

- L = 6,738 ft<sup>2</sup> / 65 ft  
 L = 104 feet, say 105 feet

#### **Step 6. Size pretreatment.**

Pass the 10-year flow event through an overflow channel.

Size pretreatment to treat ¼ of the WQ<sub>v</sub>. Therefore, treat 10,781 × 0.25 = 2,695 ft<sup>3</sup>.

For pretreatment, use a pea gravel filter layer with filter fabric, a plunge pool, and a grass channel.

##### *Pea Gravel Filter*

The pea gravel filter layer covers the entire trench with 2" (see Figure 8.19). Assuming a porosity of 0.32, the pretreatment volume (Pv) provided in the pea gravel filter layer is:

$$Pv_{\text{filter}} = (0.32)(2\text{'')}(1\text{ ft}/12\text{ inches})(125\text{'})'(50\text{'}) = 333\text{ ft}^3$$

##### *Plunge Pools*

Use a 65 'X20' triangular plunge pool with a two foot depth as flow is diverted to the infiltration trench.

$$P_{V_{\text{pool}}} = (65 \times 20 \text{ ft})/2 * (2 \text{ ft}) = 1,300 \text{ ft}^3$$

### Grass Channel

Accounting for the pretreatment volumes provided by the pea gravel filter and plunge pool, the grass channel then needs to treat at least  $(2,695 - 333 - 1,300)\text{ft}^3 = 1,062 \text{ ft}^3$

Currently stormwater flows through a 150' long channel, with parameters described under step 4. For this channel, the flow velocity of the peak flow from the water quality storm (4.6 cfs) is approximately 1.2 fps.

Using a required residence time of 10 minutes (600 seconds), the required length of channel for 100% of the  $WQ_v$  ( $10,781 \text{ ft}^3$ ) would be  $1.2 \text{ fps} \times 600 \text{ sec} = 720\text{ft}$ .

Adjust the length to account for the volume that must be provided, or:

$$(720\text{ft}) (1,062 \text{ ft}^3)/(10,781 \text{ ft}^3) = 71 \text{ ft}$$

Therefore, for this example, a grass channel length of at least 71 feet is required. 150' is OK.

**Figure 8.19 Schematic Infiltration Trench Cross Section**

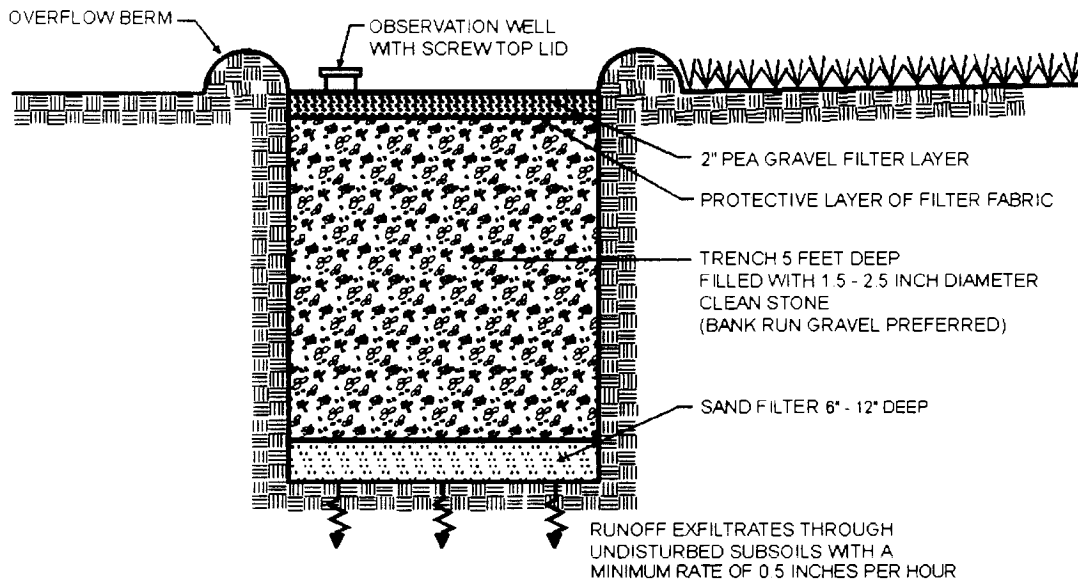

**Section 8.5 Bioretention Design Example**

This design example focuses on the design of a Bioretention area for a 4.5-acre catchment of Lake Center, a hypothetical commercial site located in Albany, NY. A five-story office building and associated parking are proposed within this catchment. The layout is shown in Figure 8.20. The catchment has 3.05 acres of impervious cover, resulting in 68% impervious cover. The pre-developed site is a mixture of forest and meadow. On-site soils are predominantly HSG “B” soils.

**Figure 8.20 Lake Center Site Plan**

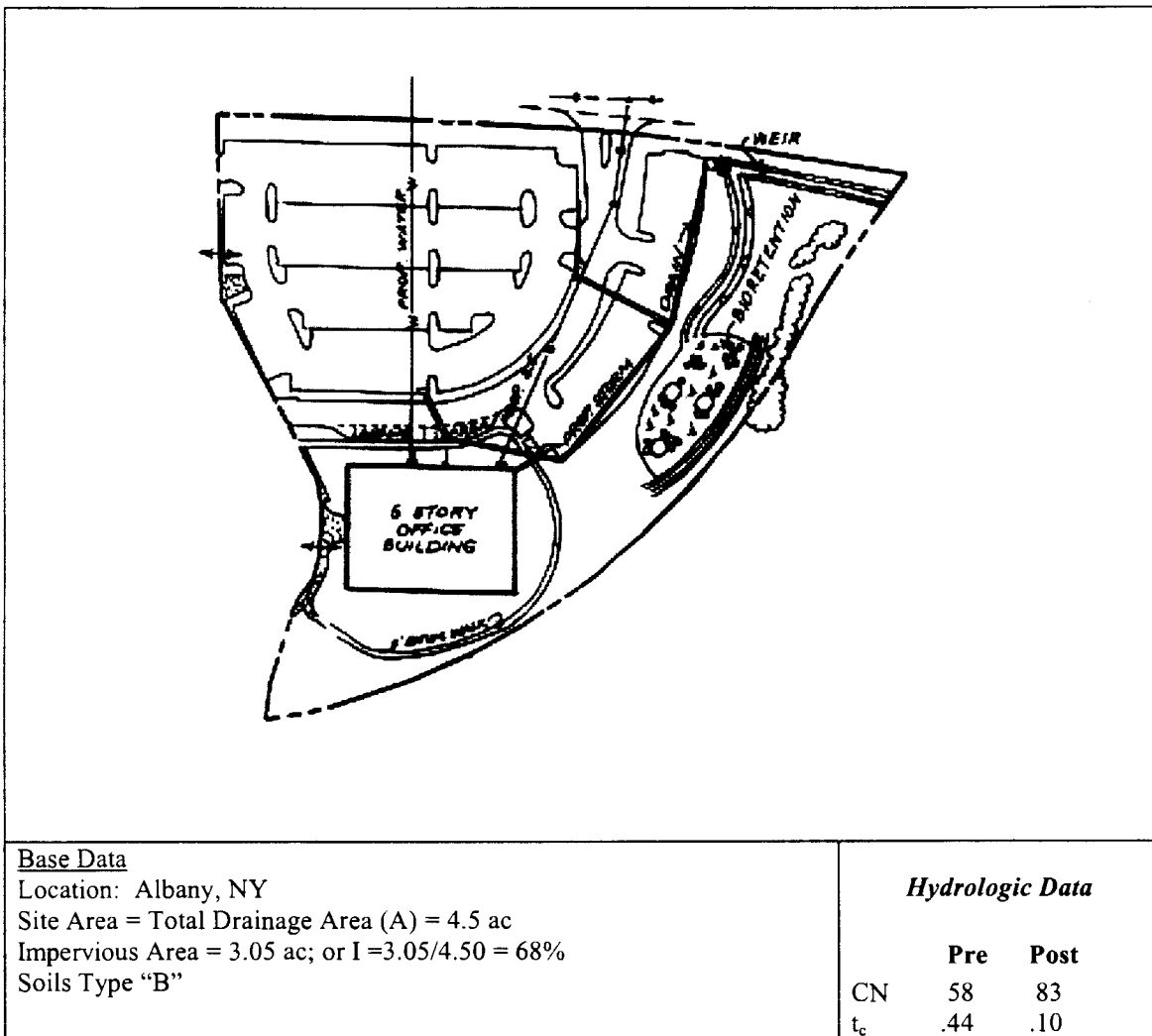

This step-by-step example will focus on meeting the water quality requirements. Channel protection control, overbank flood control, and extreme flood control are not addressed in this example. Therefore, a detailed hydrologic analysis is not presented. For an example of detailed sizing calculations, consult section 8.1. In general, the primary function of bioretention is to provide water quality treatment and not large storm attenuation. As such, flows in excess of the water quality volume are typically routed to bypass the facility. For this example, the post-development 2-year and 10-year peaks are used to appropriately size the grass channel leading to the facility.

**Step 1. Compute design volumes using the Unified Stormwater Sizing Criteria.**

Design volumes are presented in Table 8.7 below.

Table 8.7 Design Hydrology					
Condition	CN	WQ <sub>v</sub>	Q <sub>1</sub>	Q <sub>2</sub>	Q <sub>10</sub>
		<i>ft<sup>3</sup></i>	<i>cfs</i>	<i>cfs</i>	<i>cfs</i>
Pre-developed	58		0.3	0.6	4
Post-Developed	83	10,781	9	13	26

**Step 2. Determine if the development site and conditions are appropriate for the use of a bioretention area.**

Site Specific Data:

Existing ground elevation at practice location is 222.0 feet, mean sea level. Soil boring observations reveal that the seasonally high water table is at 211.0 feet and underlying soil is silt loam (ML). Adjacent channel invert is at 213 feet.



<b>Step 3. Determine size of bioretention filter area.</b>
--

$$A_f = (WQ_v) (d_f) / [ (k) (h_f + d_f) (t_f)]$$

Where:

- $A_f$  = surface area of filter bed (ft<sup>2</sup>)
- $d_f$  = filter bed depth (ft)
- $k$  = coefficient of permeability of filter media (ft/day)
- $h_f$  = average height of water above filter bed (ft)
- $t_f$  = design filter bed drain time (days) (2 days is recommended)

$$A_f = (10,781 \text{ ft}^3)(5') / [(0.5'/\text{day}) (0.25' + 5') (2 \text{ days})] \text{ (With } k = 0.5'/\text{day, } h_f = 0.25', t_f = 2 \text{ days)}$$

$$A_f = \underline{10,267 \text{ sq ft}}$$

<b>Step 4. Set design elevations and dimensions.</b>
--

Assume a roughly 2 to 1 rectangular shape. Given a filter area requirement of 10,267 sq ft, say facility is roughly 70' by 150'. Set top of facility at 219.0 feet, with the berm at 220.0 feet. The facility is 5' deep, which will allow 3' of separation distance over the seasonally high water table. See Figure 8.21 for a typical section of the facility.

**Figure 8.21 Typical Section of Bioretention Facility**

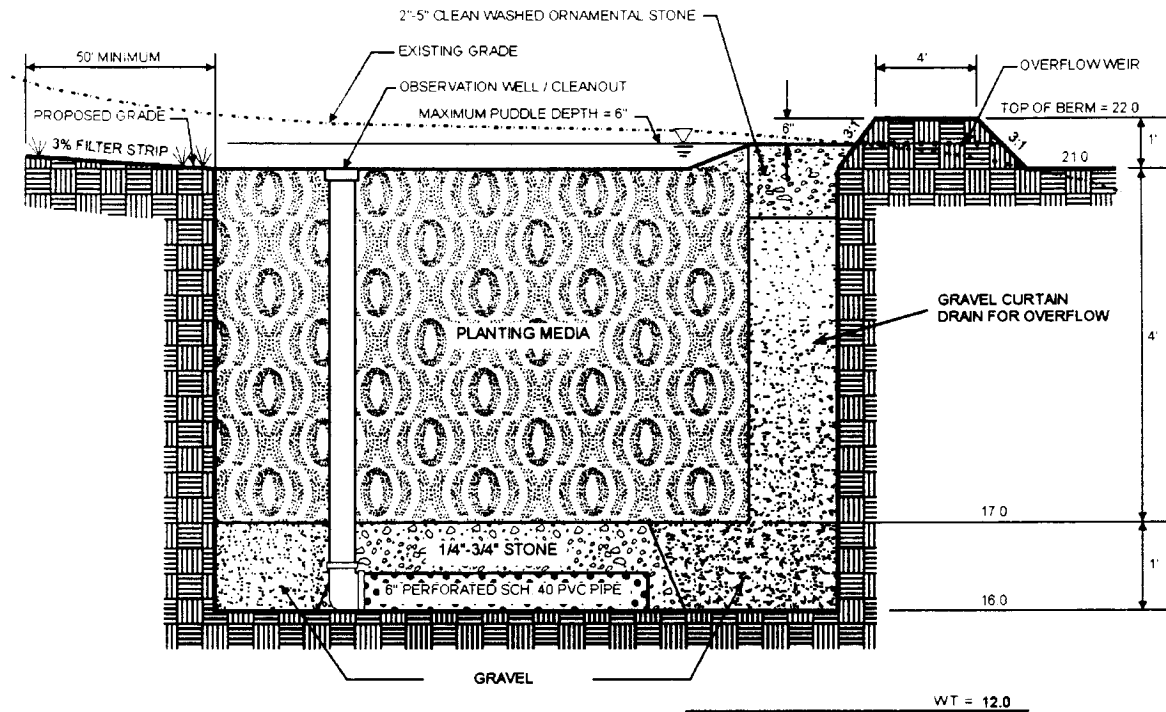

**Step 5. Size overflow channel.**

Assuming the same channel configuration as in Section 8.3, use a 4' weir set 0.63' above the base of the overflow channel. The overflow channel will flow to the adjacent drainage channel, while the water quality storm will be diverted to the bioretention cell.

**Step 6. Design Pretreatment**

Size pretreatment to treat 1/4 of the  $WQ_v$ . Therefore, treat  $10,781 \times 0.25 = 2,695 \text{ ft}^3$ .

For pretreatment, a grass channel is used. This channel has a 4' width and 3:1 side slopes.

Using the methodologies described in Section 6.3, determine that the length of channel required to treat the entire water quality volume is 720 ft. Adjust the length to correspond to the pretreatment volume, or  $L = (720 \text{ ft})(2,695/10,781) = 180\text{ft}$ .

**Step 7. Size underdrain area.**

As a rule of thumb, the length of underdrain should be based on 10% of the  $A_f$  or 1,027 sq ft and a three-foot wide zone of influence. Using 8" perforated plastic pipes surrounded by a three-foot wide gravel bed, 10' on center (o.c.), yields the following length of pipe:

$$(1,027 \text{ sq ft})/3' \text{ per foot of underdrain} = \underline{342' \text{ of perforated underdrain}}$$

**Step 8. Create overdrain design.**

To ensure against the planting media clogging, design a small ornamental stone window of 2" to 5" stone connected directly to the gravel curtain drain. This area is based on 5% of the  $A_f$  or 514 sq ft. Say 15' by 35' (see Figure 8.23).

**Step 9. Choose plants for planting area.**

Choose plants based on factors such as whether native or not, resistance to drought and inundation, cost, aesthetics, maintenance, etc. Select species locations (i.e., on center planting distances) so species will not "shade out" one another. Do not plant trees and shrubs with extensive root systems (e.g., willows) near pipe work. A potential plant list for this site is presented in Appendix H.

## References

- Allen, P. and R. Narramore. 1985. Bedrock controls on stream channel enlargement with urbanization, North Central Texas. *Water Resources Bulletin*. 21(6): 1037-1048.
- Bannerman, R.; D. Owens; R. Dodds; and N. Hornewer. 1993. Sources of Pollutants in Wisconsin Stormwater. *Water Science and Technology*. 28(3-5): 241-259.
- Booth, D., D. Montgomery, and J. Bethel. 1996. Large woody debris in the urban streams of the Pacific Northwest. *In Effects of Watershed development and Management on Aquatic Systems*. L. Roesner (ed.) Engineering Foundation Conference. Proceedings. Snowbird, UT. August 4-9, 1996. Pp. 178-197
- Booth, D. 1990. Stream channel incision following drainage basin urbanization. *Water Resources Bulletin*. 26(3): 407-417.
- Caraco, D. and R. Claytor. 1997. Stormwater BMP design supplement for cold climates. Center for Watershed Protection. Ellicott City, MD
- Cappiella, K. and K. Brown. 2001. Impervious Cover and Land Use in the Chesapeake Bay Watershed. Center for Watershed Protection, Ellicott City, Maryland.
- City of Austin, TX. 1988. Water Quality Management. *In*, Environmental Criteria Manual. Environmental and Conservation Services. Austin, TX.
- Claytor, R. and T. Schueler. 1996. Design of Stormwater Filtering Systems. Center for Watershed Protection. Ellicott City, MD.
- Crawford, J. and D. Lenat. 1989. Effects of land use on water quality and the biota of three streams in the Piedmont Province of North Carolina. USGS. Water Resources Investigations Report 89-4007. Raleigh, NC, 67 pp.
- Crunkilton, R. et al. 1996. Assessment of the response of aquatic organisms to long-term insitu exposures of urban runoff. *In: Effects of Watershed Development and Management on Aquatic Ecosystems: Proceedings of an Engineering Foundation Conference*. Snowbird, UT.
- Demers, C. and R. Sage. 1990. Effects of road deicing salts on chloride levels in four Adirondack streams. *Water, Air and Soil Pollution*. 49: 369-373.
- Dunne T. and L. Leopold. 1978. *Water in Environmental Planning*. W.H. Freeman and Company, New York, NY.
- Galli, J. 1991. Thermal impacts associated with urbanization and stormwater management best management practices. Metropolitan Washington Council of Governments. Maryland Department of Environment. Washington, D.C. 188 pp.

- Galli, J. 1990. Peat-Sand Filters: A Proposed Stormwater Management Practice for Urbanized Areas. MWCOG. Washington, DC.
- Hammer, T. 1972. Stream channel enlargement due to urbanization. *Water Resources Research*, 8(6): 1530-1540.
- Hollis, F. 1975. The effects of urbanization on floods of different recurrence intervals. *Water Resources Research*, 11:431-435.
- Horner, et al. 1996. Watershed Determinates of Ecosystem Functioning. In: *Effects of Watershed Development and Management on Aquatic Ecosystems*. Roesner, L.A. (editor). Snowbird Utah. August 4-9, 1996. Engineering Foundation.
- Kundell, J. and T. Rasmussen. 1995. Recommendations of the Georgia Board of Regent's scientific panel on evaluating the erosion measurement standard defined by the Georgia erosion and sedimentation act. In Proceedings of the 1995 Georgia Water Resources Conference. Athens, Georgia.
- Leopold, L. 1994. A View of the River. Harvard University Press, Cambridge, MA.
- MacRae, C. 1996. Experience from morphological research on Canadian streams: is control of the two-year frequency runoff event the best basis for stream channel protection? In *Effects of Watershed development and Management on Aquatic Systems*. L. Roesner (ed.) Engineering Foundation Conference. Proceedings. Snowbird, UT. August 4-9, 1996. pp. 144-160.
- MacRae, C. and M. DeAndrea, 1999. Assessing the impact of urbanization on channel morphology. 2<sup>nd</sup> International Conference on Natural Channel Systems. Niagra Falls, OT.
- MacRae C. and A. Rowney. 1992. The role of moderate flow events and bank structure in the determination of channel response to urbanization. 45<sup>th</sup> Annual Conference. Resolving Conflicts and Uncertainty in Water Management. Proceeding of the Canadian Water Resources Association. June 1992. Kingston, Ontario.
- Maryland Department of the Environment (MDE). 2000. Maryland Stormwater Design Manual. Baltimore, MD.
- Masterson, J and R. Bannerman. 1994. Impacts of storm water runoff on urban streams in Milwaukee Co., Wisconsin. In Proceedings of the American Water Resources Association, National Symposium on Water Quality. pp. 123-133.
- May, C. R. Horner, J. Karr, B. Mar, and E. Welch. 1997. Effects of Urbanization on Small Streams In the Puget Sound Lowland Ecoregion. *Watershed Protection Techniques*, 2(4): 483-494.

- Metropolitan Washington Council of Governments (MWCOG), 1992. Watershed Restoration Sourcebook. Department of Environmental Programs, MWCOG, Washington, DC.
- Metropolitan Washington Council of Governments (MWCOG). 1989. Save the Anacostia Report. Metropolitan Washington Council of Governments. Washington, D.C.
- McCuen, R. 1979. Downstream effects of stormwater management basins. Journal of the Hydraulics Division, ASCE, Vol. 105, No. HY11.
- McCuen R. and G. Moglen. 1988. Multicriterion stormwater management methods. Journal of Water Resources Planning and Management. (114) 4.
- Monroe County Environmental Management Council. 1987. The use of road deicing salt on state roads in Monroe County. Monroe County, NY.
- Morisawa, M and E. La Flure. 1979. Hydraulic geometry, stream equilization and urbanization. In the Proceedings of the Tenth Annual Geomorphology Symposia Series entitled "Adjustments of the Fluvial System" held in Binghamton, NY. September 21-22, 1979. Kendall/Hunt Publishing Company, Dubuque, IA.
- Natural Resources Conservation Service. 1986. Urban Hydrology for Small Watersheds. Technical Release No. 55. USDA. Washington D.C.
- Natural Resources Conservation Service. 1984. Engineering Field Manual for Conservation Practices. USDA. Washington D.C.
- Natural Resources Defense Council. 2000. Testing the Waters: A Guide to Water Quality at Vacation Beaches. Available online at. <http://www.nrdc.org>
- New York City Department of Environmental Protection (NYC DEP). 1999. Development of a water quality guidance value for Phase II Total Maximum Daily Loads (TMDLs) in the New York City Reservoirs. Prepared by Dr. Kimberlee Kane, Dr. Michael A. Principe, and Dr. Carol Stepczuk, Division of Drinking Water Quality Control, Bureau of Water Supply, Quality and Protection..
- New York Department of Environmental Conservation (NY DEC). 1989. Guidelines for Design of Dams. Albany, NY.
- Oberts, G. 1994. Influence of snowmelt dynamics on stormwater runoff quality. *Watershed Protection Techniques*. 1(2):55-61.
- Pitt, R. 1995. Effects of Urban Runoff on Aquatic Biota. In Handbook of Ecotoxicology. Lewis Publishers/CRC Press, Inc., Boca Raton, Florida.
- Rabanal, F. and T. Grizzard. 1995. Concentrations of selected constituents in runoff from impervious surfaces in four urban land use catchments of different land use. In Proceedings of the 4<sup>th</sup> Biennial Stormwater Research Conference. Clearwater, FL.

- Richey, J.S. 1982. Effects of urbanization on a lowland stream in urban Washington. PhD Dissertation. University of Washington.
- Sauer V. *et al.* 1983. Flood Characteristics of Urban Watersheds in the United States. US Geological Survey Water Supply Paper 2207.
- Schueler, T. 1999. Microbes and Urban Watersheds. *Watershed Protection Techniques*. 3(1): 551-596.
- Schueler, T. 1994. The Importance of Imperviousness. *Watershed Protection Techniques* 1(3): 100-111.
- Schueler, T. 1987. Controlling urban runoff: a practical manual for planning and designing urban BMPs. Metropolitan Washington Council of Governments. Washington, DC
- Scott, J., C. Steward and Q. Stober. 1986. Effects of urban development on fish population dynamics in Kelsey Creek, Washington. *Transactions of the American Fisheries Society*. 115:555-567.
- Smullen, J. and K. Cave. 1998. Updating the U.S. Nationwide Urban Runoff Quality Database. 3<sup>rd</sup> International Conference on Diffuse Pollution. August 31 - September 4, 1998. Scottish Environment Protection Agency, Edinburg Scotland.
- Spence, B., G. Lomnický, R. Hughes, and R. Novitzki. 1996. An Ecosystem Approach to Salmonid Conservation. TR-401-96-6057. ManTech Environmental Research Services Corporation, Corvallis, OR. (Available on the NMFS-NWR website: <http://www.nwr.noaa.gov>)
- Spinello, A.G., D.L. Simmons. 1992. Base Flow of 10 South-Shore Streams, Long Island, New York, 1976-1985, and the Effects of Urbanization on Base Flow and Flow Duration. United States Geological Survey. *Water Resources Investigative Report* 90-4205.
- Steuer, Jeffrey, William Selbig, Nancy Hornewer, and Jeffrey Prey. 1997. Sources of Contamination in an Urban Basin in Marquette, Michigan and an Analysis of Concentrations, Loads, and Data Quality. U.S. Geological Survey, Water-Resources Investigations Report 97-4242.
- Taylor, B.L. 1993. The influences of wetland and watershed morphological characteristics and relationships to wetland vegetation communities. Master's thesis. Dept. of Civil Engineering. University of Washington, Seattle, WA.
- Trimble, S. 1997. Contribution of stream channel erosion to sediment yield from and urbanizing watershed. *Science*. 278: 1442-1444.
- US Environmental Protection Agency. 1993. Guidance Specifying Management Measures for Sources of Nonpoint Pollution in Coastal Waters. EPA-840-B-92-002. U.S. EPA, Office of Water, Washington, DC

- Waschbusch *et al.* 2000. Sources of phosphorus in stormwater and street dirt from two urban residential basins in Madison, Wisconsin, 1994-1995. In: National Conference on Tools for Urban Water Resource Management and Protection. US EPA February 2000: pp. 15-55.
- Washington State Department of Ecology. 1992. Stormwater Management Manual for the Puget Sound Basin (Technical Manual).
- Winer, R. 2000. National Pollutant Removal Database for Stormwater Treatment Practices: 2<sup>nd</sup> Edition. Center for Watershed Protection. Ellicott City
- Woodward - Clyde Consultants 1992. Source Identification and Control Report. Prepared for the Santa Clara Valley Nonpoint Source Control Program. Oakland, California.
- Yoder, C., R. Miltner, and D. White. 1999. Assessing the Status of Aquatic Life Designated Uses in Urban and Suburban Watersheds. pp 16-28. In R. Kirschener (ed.) Proceedings of the *National Conference on Retrofit Opportunities for Water Resource Protection in Urban Environments*. EPA/625/R-99/002
- Yoder C., 1991. The integrated biosurvey as a tool for evaluation of aquatic life use attainment and impairment in Ohio surface waters. in *Biological Criteria: Research and Regulation*; 1991.



# Glossary

New York State Stormwater Management Design Manual

R0080406

## Glossary

ANTI-SEEP COLLAR - An impermeable diaphragm usually of sheet metal or concrete constructed at intervals within the zone of saturation along the conduit of a principal spillway to increase the seepage length along the conduit and thereby prevent piping or seepage along the conduit.

ANTI-VORTEX DEVICE - A device designed and placed on the top of a riser or at the entrance of a pipe to prevent the formation of a vortex in the water at the entrance.

AQUATIC BENCH - A ten to fifteen foot wide bench which is located around the inside perimeter of a permanent pool and is normally vegetated with aquatic plants; the goal is to provide pollutant removal and enhance safety in areas using stormwater pond SMP's.

AQUIFER - A geological formation which contains and transports groundwater.

"AS-BUILT" - Drawing or certification of conditions as they were actually constructed.

BAFFLES - Guides, grids, grating or similar devices placed in a pond to deflect or regulate flow and create a longer flow path.

BANKFULL FLOW - The condition where streamflow just fills a stream channel up to the top of the bank and at a point where the water begins to overflow onto a floodplain.

BARREL - The closed conduit used to convey water under or through an embankment; part of the principal spillway.

BASE FLOW - The stream discharge from ground water.

BERM - A shelf that breaks the continuity of a slope; a linear embankment or dike.

BIORETENTION - A water quality practice that utilizes landscaping and soils to treat urban stormwater runoff by collecting it in shallow depressions, before filtering through a fabricated planting soil media.

CHANNEL - A natural stream that conveys water; a ditch or channel excavated for the flow of water.

CHANNEL STABILIZATION - Erosion prevention and stabilization of velocity distribution in a channel using jetties, drops, revetments, structural linings, vegetation and other measures.

CHECK DAM - A small dam constructed in a gully or other small watercourse to decrease the stream flow velocity (by reducing the channel gradient), minimize channel scour, and promote deposition of sediment.

CHUTE - A high velocity, open channel for conveying water to a lower level without erosion.

CLAY (SOILS) - 1. A mineral soil separate consisting of particles less than 0.002 millimeter in equivalent diameter. 2. A soil texture class. 3. (Engineering) A fine grained soil (more than 50 percent passing the No. 200 sieve) that has a high plasticity index in relation to the liquid limit. (Unified Soil Classification System)

COCONUT ROLLS - Also known as coir rolls, these are rolls of natural coconut fiber designed to be used for streambank stabilization.

COMPACTION (SOILS) - Any process by which the soil grains are rearranged to decrease void space and bring them in closer contact with one another, thereby increasing the weight of solid material per unit of volume, increasing the shear and bearing strength and reducing permeability.

CONDUIT - Any channel intended for the conveyance of water, whether open or closed.

CONTOUR - 1. An imaginary line on the surface of the earth connecting points of the same elevation. 2. A line drawn on a map connecting points of the same elevation.

CORE TRENCH - A trench, filled with relatively impervious material intended to reduce seepage of water through porous strata.

CRADLE - A structure usually of concrete shaped to fit around the bottom and sides of a conduit to support the conduit, increase its strength and in dams, to fill all voids between the underside of the conduit and the soil.

CREST - 1. The top of a dam, dike, spillway or weir, frequently restricted to the overflow portion. 2. The summit of a wave or peak of a flood.

CRUSHED STONE - Aggregate consisting of angular particles produced by mechanically crushing rock.

CURVE NUMBER (CN) - A numerical representation of a given area's hydrologic soil group, plant cover, impervious cover, interception and surface storage derived in accordance with Natural Resources Conservation Service methods. This number is used to convert rainfall volume into runoff volume.

CUT - Portion of land surface or area from which earth has been removed or will be removed by excavation; the depth below original ground surface to excavated surface.

CUT-AND-FILL - Process of earth moving by excavating part of an area and using the excavated material for adjacent embankments or fill areas.

CUTOFF - A wall or other structure, such as a trench, filled with relatively impervious material intended to reduce seepage of water through porous strata.

CZARA - Acronym used for the Coastal Zone Act Reauthorization Amendments of 1990. These amendments sought to address the issue of nonpoint source pollution issue by requiring states to develop Coastal Nonpoint Pollution Control Programs in order to receive federal funds.

DAM - A barrier to confine or raise water for storage or diversion, to create a hydraulic head, to prevent gully erosion, or for retention of soil, sediment or other debris.

DETENTION - The temporary storage of storm runoff in a SMP with the goals of controlling peak discharge rates and providing gravity settling of pollutants.

**DETENTION STRUCTURE** - A structure constructed for the purpose of temporary storage of stream flow or surface runoff and gradual release of stored water at controlled rates.

**DIKE** - An embankment to confine or control water, for example, one built along the banks of a river to prevent overflow or lowlands; a levee.

**DISTRIBUTED RUNOFF CONTROL (DRC)** - A stream channel protection criteria which utilizes a non-uniform distribution of the storage stage-discharge relationship within a SMP to minimize the change in channel erosion potential from predeveloped to developed conditions.

**DISTURBED AREA** - An area in which the natural vegetative soil cover has been removed or altered and, therefore, is susceptible to erosion.

**DIVERSION** - A channel with a supporting ridge on the lower side constructed across the slope to divert water from areas where it is in excess to sites where it can be used or disposed of safely. Diversions differ from terraces in that they are individually designed.

**DRAINAGE** - 1. The removal of excess surface water or ground water from land by means of surface or subsurface drains. 2. Soils characteristics that affect natural drainage.

**DRAINAGE AREA (WATERSHED)** - All land and water area from which runoff may run to a common (design) point.

**DROP STRUCTURE** - A structure for dropping water to a lower level and dissipating surplus energy; a fall. The drop may be vertical or inclined.

**DRY SWALE** - An open drainage channel explicitly designed to detain and promote the filtration of stormwater runoff through an underlying fabricated soil media.

**EMERGENCY SPILLWAY** - A dam spillway designed and constructed to discharge flow in excess of the principal spillway design discharge.

**ENERGY DISSIPATOR** - A designed device such as an apron of rip-rap or a concrete structure placed at the end of a water transmitting apparatus such as pipe, paved ditch or paved chute for the purpose of reducing the velocity, energy and turbulence of the discharged water.

**EROSION** - 1. The wearing away of the land surface by running water, wind, ice, or other geological agents, including such processes as gravitational creep. 2. Detachment and movement of soil or rock fragments by water, wind, ice or gravity. The following terms are used to describe different types of water erosion:

**Accelerated erosion** - Erosion much more rapid than normal, natural or geologic erosion, primarily as a result of the influence of the activities of man or, in some cases, of other animals or natural catastrophes that expose base surfaces, for example, fires.

**Gully erosion** - The erosion process whereby water accumulates in narrow channels and, over short periods, removes the soil from this narrow area to considerable depths, ranging from 1 or 2 feet to as much as 75 to 100 feet.

**Rill erosion** - An erosion process in which numerous small channels only several inches deep are formed. See rill.

**Sheet erosion** - The spattering of small soil particles caused by the impact of raindrops on wet soils. The loosened and spattered particles may or may not subsequently be removed by surface runoff.

**EROSIVE VELOCITIES** - Velocities of water that are high enough to wear away the land surface. Exposed soil will generally erode faster than stabilized soils. Erosive velocities will vary according to the soil type, slope, structural, or vegetative stabilization used to protect the soil.

**EXFILTRATION** - The downward movement of water through the soil; the downward flow of runoff from the bottom of an infiltration SMP into the soil.

EXTENDED DETENTION (ED) - A stormwater design feature that provides for the gradual release of a volume of water over a 12 to 48 hour interval in order to increase settling of urban pollutants and protect downstream channels from frequent storm events.

EXTREME FLOOD ( $Q_p$ ) - The storage volume required to control those infrequent but large storm events in which overbank flows approach the floodplain boundaries of the 100-year flood.

FILTER BED - The section of a constructed filtration device that houses the filter media and the outflow piping.

FILTER FENCE - A geotextile fabric designed to trap sediment and filter runoff.

FILTER MEDIA - The sand, soil, or other organic material in a filtration device used to provide a permeable surface for pollutant and sediment removal.

FILTER STRIP - A strip of permanent vegetation above ponds, diversions and other structures to retard flow of runoff water, causing deposition of transported material, thereby reducing sediment flow.

FINES (SOIL) - Generally refers to the silt and clay size particles in soil.

FLOODPLAIN - Areas adjacent to a stream or river that are subject to flooding or inundation during a storm event that occurs, on average, once every 100 years (or has a likelihood of occurrence of 1/100 in any given year).

FLOW SPLITTER - An engineered, hydraulic structure designed to divert a percentage of storm flow to a SMP located out of the primary channel, or to direct stormwater to a parallel pipe system, or to bypass a portion of baseflow around a SMP.

FOREBAY - Storage space located near a stormwater SMP inlet that serves to trap incoming coarse sediments before they accumulate in the main treatment area.

FREEBOARD (HYDRAULICS) - The distance between the maximum water surface elevation anticipated in design and the top of retaining banks or structures. Freeboard is provided to prevent overtopping due to unforeseen conditions.

FOURTH ORDER STREAM - Designation of stream size where many water quantity requirements may not be needed. A first order stream is identified by "blue lines" on USGS quad sheets. A second order stream is the confluence of two first order streams, and so on.

FRENCH DRAIN - A type of drain consisting of an excavated trench refilled with pervious material, such as coarse sand, gravel or crushed stone, through whose voids water percolates and flows to an outlet.

GABION - A flexible woven-wire basket composed of two to six rectangular cells filled with small stones. Gabions may be assembled into many types of structures such as revetments, retaining walls, channel liners, drop structures and groins.

GABION MATTRESS - A thin gabion, usually six or nine inches thick, used to line channels for erosion control.

GRADE - 1. The slope of a road, channel or natural ground. 2. The finished surface of a canal bed, roadbed, top of embankment, or bottom of excavation; any surface prepared for the support of construction, like paving or laying a conduit. 3. To finish the surface of a canal bed, roadbed, top of embankment or bottom of excavation.

GRASS CHANNEL - A open vegetated channel used to convey runoff and to provide treatment by filtering out pollutants and sediments.

GRAVEL - 1. Aggregate consisting of mixed sizes of 1/4 inch to 3 inch particles which normally occur in or near old streambeds and have been worn smooth by the action of water. 2. A soil having particle sizes, according to the Unified Soil Classification System, ranging from the No. 4 sieve size angular in shape as produced by mechanical crushing.

GRAVEL DIAPHRAGM - A stone trench filled with small, river-run gravel used as pretreatment and inflow regulation in stormwater filtering systems.

GRAVEL FILTER - Washed and graded sand and gravel aggregate placed around a drain or well screen to prevent the movement of fine materials from the aquifer into the drain or well.

GRAVEL TRENCH - A shallow excavated channel backfilled with gravel and designed to provide temporary storage and permit percolation of runoff into the soil substrate.

GROUND COVER - Plants which are low-growing and provide a thick growth which protects the soil as well as providing some beautification of the area occupied.

GULLY - A channel or miniature valley cut by concentrated runoff through which water commonly flows only during and immediately after heavy rains or during the melting of snow. The distinction between gully and rill is one of depth. A gully is sufficiently deep that it would not be obliterated by normal tillage operations, whereas a rill is of lesser depth and would be smoothed by ordinary farm tillage.

HEAD (HYDRAULICS) - 1. The height of water above any plane of reference. 2. The energy, either kinetic or potential, possessed by each unit weight of a liquid expressed as the vertical height through which a unit weight would have to fall to release the average energy possessed. Used in various terms such as pressure head, velocity head, and head loss.

HERBACEOUS PERENNIAL (PLANTS) - A plant whose stems die back to the ground each year.

HI MARSH - A pondscaping zone within a stormwater wetland which exists from the surface of the normal pool to a six inch depth and typically contains the greatest density and diversity of emergent wetland plants.

HI MARSH WEDGES - Slices of shallow wetland (less than or equal to 6 inches) dividing a stormwater wetland.

HOT SPOT - Area where land use or activities generate highly contaminated runoff, with concentrations of pollutants in excess of those typically found in stormwater.

HYDRAULIC GRADIENT - The slope of the hydraulic grade line. The slope of the free surface of water flowing in an open channel.

HYPOXIA - Lack of oxygen in a waterbody resulting from eutrophication.

HYDROGRAPH - A graph showing variation in stage (depth) or discharge of a stream of water over a period of time.

HYDROLOGIC SOIL GROUP (HSG) - A Natural Resource Conservation Service classification system in which soils are categorized into four runoff potential groups. The groups range from A soils, with high permeability and little runoff production, to D soils, which have low permeability rates and produce much more runoff.

HYDROSEED - Seed or other material applied to areas in order to revegetate after a disturbance.

IMPERVIOUS COVER (I) - Those surfaces in the urban landscape that cannot effectively infiltrate rainfall consisting of building rooftops, pavement, sidewalks, driveways, etc.

INDUSTRIAL STORMWATER PERMIT - An NPDES permit issued to a commercial industry or group of industries which regulates the pollutant levels associated with industrial storm water discharges or specifies on-site pollution control strategies.

INFILTRATION RATE ( $F_c$ ) - The rate at which stormwater percolates into the subsoil measured in inches per hour.

INFLOW PROTECTION - A water handling device used to protect the transition area between any water conveyance (dike, swale, or swale dike) and a sediment trapping device.

LEVEL SPREADER - A device for distributing stormwater uniformly over the ground surface as sheet flow to prevent concentrated, erosive flows and promote infiltration.

MANNING'S FORMULA (HYDRAULICS) - A formula used to predict the velocity of water flow in an open channel or pipeline:

$$V = \frac{1.486 R^{2/3} S^{1/2}}{n}$$

Where V is the mean velocity of flow in feet per second; R is the hydraulic radius; S is the slope of the energy gradient or for assumed uniform flow the slope of the channel, in feet per foot; and n is the roughness coefficient or retardance factor of the channel lining.

MICROPOOL - A smaller permanent pool which is incorporated into the design of larger stormwater ponds to avoid resuspension or settling of particles and minimize impacts to adjacent natural features.

MICROTOPOGRAPHY - The complex contours along the bottom of a shallow marsh system, providing greater depth variation which increases the wetland plant diversity and increases the surface area to volume ratio of a stormwater wetland.

MULCH - Covering on surface of soil to protect and enhance certain characteristics, such as water retention qualities.

MUNICIPAL STORMWATER PERMIT - A SPDES permit issued to municipalities to regulate discharges from municipal separate storm sewers for compliance with EPA established water quality standards and/or to specify stormwater control strategies.

NPDES - Acronym for the National Pollutant Discharge Elimination System, which regulates point source and non-point source discharge.

NITROGEN-FIXING (BACTERIA) - Bacteria having the ability to fix atmospheric nitrogen, making it available for use by plants. Inoculation of legume seeds is one way to insure a source of these bacteria for specified legumes.

NORMAL DEPTH - Depth of flow in an open conduit during uniform flow for the given conditions.

OUTFALL - The point where water flows from a conduit, stream, or drain.

OFF-LINE - A stormwater management system designed to manage a storm event by diverting a percentage of stormwater events from a stream or storm drainage system.

ON-LINE - A stormwater management system designed to manage stormwater in its original stream or drainage channel.

ONE YEAR STORM (Q<sub>p1</sub>) - A stormwater event which occurs on average once every year or statistically has a 100% chance on average of occurring in a given year.

ONE HUNDRED YEAR STORM (Q<sub>p100</sub>) - A extreme flood event which occurs on average once every 100 years or statistically has a 1% chance on average of occurring in a given year.

OPEN CHANNELS - Also known as swales, grass channels, and biofilters. These systems are used for the conveyance, retention, infiltration and filtration of stormwater runoff.

OUTLET - The point at which water discharges from such things as a stream, river, lake, tidal basin, pipe, channel or drainage area.

OUTLET CHANNEL - A waterway constructed or altered primarily to carry water from man-made structures such as terraces, subsurface drains, diversions and impoundments.

PEAK DISCHARGE RATE - The maximum instantaneous rate of flow during a storm, usually in reference to a specific design storm event.

PERMANENT SEEDING - Results in establishing perennial vegetation which may remain on the area for many years.

PERMEABILITY - The rate of water movement through the soil column under saturated conditions

PERMISSIBLE VELOCITY (HYDRAULICS) - The highest average velocity at which water may be carried safely in a channel or other conduit. The highest velocity that can exist through a substantial length of a conduit and not cause scour of the channel. A safe, non-eroding or allowable velocity

pH - A number denoting the common logarithm of the reciprocal of the hydrogen ion concentration. A pH of 7.0 denotes neutrality, higher values indicate alkalinity, and lower values indicate acidity.

PIPING - Removal of soil material through subsurface flow channels or “pipes” developed by seepage water.

PLUGS - Pieces of turf or sod, usually cut with a round tube, which can be used to propagate the turf or sod by vegetative means.

POCKET POND - A stormwater pond designed for treatment of small drainage area (< 5 acres) runoff and which has little or no baseflow available to maintain water elevations and relies on ground water to maintain a permanent pool.

POCKET WETLAND - A stormwater wetland design adapted for the treatment of runoff from small drainage areas (< 5 acres) and which has little or no baseflow available to maintain water elevations and relies on ground water to maintain a permanent pool.

POND BUFFER - The area immediately surrounding a pond which acts as filter to remove pollutants and provide infiltration of stormwater prior to reaching the pond. Provides a separation barrier to adjacent development.

POND DRAIN - A pipe or other structure used to drain a permanent pool within a specified time period.

PONDSCAPING - Landscaping around stormwater ponds which emphasizes native vegetative species to meet specific design intentions. Species are selected for up to six zones in the pond and its surrounding buffer, based on their ability to tolerate inundation and/ or soil saturation.

POROSITY - Ratio of pore volume to total solids volume.

PRETREATMENT - Techniques employed in stormwater SMPs to provide storage or filtering to help trap coarse materials before they enter the system.

PRINCIPAL SPILLWAY - The primary pipe or weir which carries baseflow and storm flow through the embankment.

REDEVELOPMENT - New development activities on previously developed land.

RETENTION - The amount of precipitation on a drainage area that does not escape as runoff. It is the difference between total precipitation and total runoff.

REVERSE-SLOPE PIPE - A pipe which draws from below a permanent pool extending in a reverse angle up to the riser and which determines the water elevation of the permanent pool.

RIGHT-OF-WAY - Right of passage, as over another’s property. A route that is lawful to use. A strip of land acquired for transport or utility construction.

RIP-RAP - Broken rock, cobbles, or boulders placed on earth surfaces, such as the face of a dam or the bank of a stream, for protection against the action of water (waves); also applies to brush or pole mattresses, or brush and stone, or similar materials used for soil erosion control.



RISER - A vertical pipe or structure extending from the bottom of a pond SMP and houses the control devices (weirs/orifices) to achieve the discharge rates for specified designs.

ROUGHNESS COEFFICIENT (HYDRAULICS) - A factor in velocity and discharge formulas representing the effect of channel roughness on energy losses in flowing water. Manning's "n" is a commonly used roughness coefficient.

RUNOFF (HYDRAULICS) - That portion of the precipitation on a drainage area that is discharged from the area in the stream channels. Types include surface runoff, ground water runoff or seepage.

RUNOFF COEFFICIENT ( $R_v$ ) - A value derived from a site impervious cover value that is applied to a given rainfall volume to yield a corresponding runoff volume.

SAFETY BENCH - A flat area above the permanent pool and surrounding a stormwater pond designed to provide a separation from the pond pool and adjacent slopes.

SAND - 1. (Agronomy) A soil particle between 0.05 and 2.0 millimeters in diameter. 2. A soil textural class. 3. (Engineering) According to the Unified Soil Classification System, a soil particle larger than the No. 200 sieve (0.074mm) and passing the No. 4 sieve (approximately 1/4 inch).

SEDIMENT - Solid material, both mineral and organic, that is in suspension, being transported, or has been moved from its site of origin by air, water, gravity, or ice and has come to rest on the earth's surface either above or below sea level.

SEEPAGE - 1. Water escaping through or emerging from the ground. 2. The process by which water percolates through the soil.

SEEPAGE LENGTH - In sediment basins or ponds, the length along the pipe and around the anti-seep collars that is within the seepage zone through an embankment.

SETBACKS - The minimum distance requirements for location of a structural SMP in relation to roads, wells, septic fields, other structures.

SHEET FLOW - Water, usually storm runoff, flowing in a thin layer over the ground surface.

SIDE SLOPES (ENGINEERING) - The slope of the sides of a channel, dam or embankment. It is customary to name the horizontal distance first, as 1.5 to 1, or frequently, 1 ½: 1, meaning a horizontal distance of 1.5 feet to 1 foot vertical.

SILT - 1. (Agronomy) A soil separate consisting of particles between 0.05 and 0.002 millimeter in equivalent diameter. 2. A soil textural class. 3. (Engineering) According to the Unified Soil Classification System a fine grained soil (more than 50 percent passing the No. 200 sieve) that has a low plasticity index in relation to the liquid limit.

SOIL TEST - Chemical analysis of soil to determine needs for fertilizers or amendments for species of plant being grown.

SPILLWAY - An open or closed channel, or both, used to convey excess water from a reservoir. It may contain gates, either manually or automatically controlled to regulate the discharge of excess water.

STABILIZATION - Providing adequate measures, vegetative and/or structural that will prevent erosion from occurring.

STAGE (HYDRAULICS) - The variable water surface or the water surface elevation above any chosen datum.

STILLING BASIN - An open structure or excavation at the foot of an outfall, conduit, chute, drop, or spillway to reduce the energy of the descending stream of water.

STORMWATER FILTERING - Stormwater treatment methods which utilize an artificial media to filter out pollutants entrained in urban runoff.

STORMWATER PONDS - A land depression or impoundment created for the detention or retention of stormwater runoff.

STORMWATER WETLANDS - Shallow, constructed pools that capture stormwater and allow for the growth of characteristic wetland vegetation.

STREAM BUFFERS - Zones of variable width which are located along both sides of a stream and are designed to provide a protective natural area along a stream corridor.

STREAM CHANNEL PROTECTION ( $C_{pv}$ ) - A design criteria which requires 24 hour detention of the one year postdeveloped, 24 hour storm event for the control of stream channel erosion.

STRUCTURAL SMPs - Devices which are constructed to provide temporary storage and treatment of stormwater runoff.

SUBGRADE - The soil prepared and compacted to support a structure or a pavement system.

TAILWATER - Water, in a river or channel, immediately downstream from a structure.

TECHNICAL RELEASE No. 20 (TR-20) - A Soil Conservation Service (now NRCS) watershed hydrology computer model that is used to compute runoff volumes and route storm events through a stream valley and/or ponds.

TECHNICAL RELEASE No. 55 (TR-55) - A watershed hydrology model developed by the Soil Conservation Service (now NRCS) used to calculate runoff volumes and provide a simplified routing for storm events through ponds.

TEMPORARY SEEDING - A seeding which is made to provide temporary cover for the soil while waiting for further construction or other activity to take place.

TEN YEAR STORM ( $Q_{P 10}$ ) - The peak discharge rate associated with a 24 hour storm event that occurs on average once every ten years (or has a likelihood of occurrence of 1/10 in a given year).

TIME OF CONCENTRATION - Time required for water to flow from the most remote point of a watershed, in a hydraulic sense, to the outlet.

TOE (OF SLOPE) - Where the slope stops or levels out. Bottom of the slope.

TOE WALL - Downstream wall of a structure, usually to prevent flowing water from eroding under the structure.

TOPSOIL - Fertile or desirable soil material used to top dress roadbanks, subsoils, parent material, etc.

TOTAL SUSPENDED SOLIDS - The total amount of soil particulate matter, including both organic and inorganic material, suspended in the water column.

TRASH RACK - Grill, grate or other device at the intake of a channel, pipe, drain or spillway for the purpose of preventing oversized debris from entering the structure.

TROUT WATERS - Waters classified as (T) or (TS) by the New York State DEC.

TWO YEAR STORM ( $Q_{P 2}$ ) - The peak discharge rate associated with a 24 hour storm event that occurs on average once every two years (or has a likelihood of occurrence of 1/2 in a given year).

ULTIMATE CONDITION - Full watershed build-out based on existing zoning.

ULTRA-URBAN - Densely developed urban areas in which little pervious surface exists.

VELOCITY HEAD - Head due to the velocity of a moving fluid, equal to the square of the mean velocity divided by twice the acceleration due to gravity (32.16 feet per second per second).

VOLUMETRIC RUNOFF COEFFICIENT ( $R_v$ ) - The value that is applied to a given rainfall volume to yield a corresponding runoff volume based on the percent impervious cover in a drainage basin.

WATER QUALITY VOLUME ( $WQ_v$ ) - The storage needed to capture and treat 90% of the average annual stormwater runoff volume.

WATER SURFACE PROFILE - The longitudinal profile assumed by the surface of a stream flowing in an open channel; the hydraulic grade line.

WEDGES - Design feature in stormwater wetlands which increases flow path length to provide for extended detention and treatment of runoff.

WET SWALE - An open drainage channel or depression, explicitly designed to retain water or intercept groundwater for water quality treatment.

WETTED PERIMETER - The length of the line of intersection of the plane or the hydraulic cross-section with the wetted surface of the channel.

WING WALL - Side wall extensions of a structure used to prevent sloughing of banks or channels and to direct and confine overfall.

## Appendix A: The Simple Method to Calculate Urban Stormwater Loads

This appendix presents data and methodologies for using the Simple Method (Schueler, 1987) to estimate pollutant load from a site or drainage area. This appendix is meant for planning purposes only, and should not be used for SMP design.

The Simple Method estimates stormwater runoff pollutant loads for urban areas. The technique requires a modest amount of information, including the subwatershed drainage area and impervious cover, stormwater runoff pollutant concentrations, and annual precipitation. With the Simple Method, the investigator can either break up land use into specific areas, such as residential, commercial, industrial, and roadway and calculate annual pollutant loads for each type of land, or utilize more generalized pollutant values for urban runoff. It is also important to note that these values may vary depending on other variables such as the age of development.

The Simple Method estimates pollutant loads for chemical constituents as a product of annual runoff volume and pollutant concentration, as:

$$L = 0.226 * R * C * A$$

Where: L = Annual load (lbs)  
R = Annual runoff (inches)  
C = Pollutant concentration (mg/l)  
A = Area (acres)  
0.226 = Unit conversion factor

For bacteria, the equation is slightly different, to account for the differences in units. The modified equation for bacteria is:

$$L = 103 * R * C * A$$

Where: L = Annual load (Billion Colonies)  
R = Annual runoff (inches)  
C = Bacteria concentration (1,000/ ml)  
A = Area (acres)  
103 = Unit conversion factor

### A.1 Pollutant Concentrations

Stormwater pollutant concentrations can be estimated from local or regional data, or from national data sources. Table A.1 presents typical concentration data for pollutants in urban stormwater.

Table A.1 National Median Concentrations for Chemical Constituents in Stormwater		
Constituent	Units	Urban Runoff
TSS	mg/l	54.5 <sup>1</sup>
TP	mg/l	0.26 <sup>1</sup>
TN	mg/l	2.00 <sup>1</sup>
Cu	ug/l	11.1 <sup>1</sup>
Pb	ug/l	50.7 <sup>1</sup>
Zn	ug/l	129 <sup>1</sup>
F Coli	1,000 col/ ml	1.5 <sup>2</sup>
Source:		
1: Pooled NURP/USGS (Smullen and Cave, 1998)		
2: Schueler (1999)		

In addition, some source areas appear to be particularly important for some pollutants. Table A.2 summarizes these data for several key source areas. It is important to note that, because the Simple Method computes runoff based on an impervious area fraction, it cannot be easily used to isolate pervious sources, such as lawns. However, a user can evaluate particular hotspots, such as auto recyclers, separately. In addition, a composite runoff concentration can be developed based on the fraction of lawn, driveway, and roof on a residential site, for example.

Table A.2 Pollutant Concentrations from Source Areas							
Constituent	TSS <sup>1</sup>	TP <sup>2</sup>	TN <sup>3</sup>	F Coli <sup>1</sup>	Cu <sup>1</sup>	Pb <sup>1</sup>	Zn <sup>1</sup>
	mg/l	mg/L	mg/l	1,000 col/ ml	ug/l	ug/l	ug/l
Resid Roof	19	0.11	1.5	0.26	20	21	312
Comm Roof	9	0.14	2.1	1.1	7	17	256
Indust Roof	17	-	-	5.8	62	43	1,390
C/R Parking	27	0.15	1.9	1.8	51	28	139
Indust Parking	228	-	-	2.7	34	85	224
Res Street	172	0.55	1.4	37	25	51	173
Comm Street	468	-	-	12	73	170	450
Rural Highway	51	-	22	-	22	80	80
Urban Highway	142	0.32	3.0	-	54	400	329
Lawns	602	2.1	9.1	24	17	17	50
Landscaping	37	-	-	94	94	29	263
Driveway	173	0.56	2.1	17	17	-	107
Gas Station	31	-	-	-	88	80	290
Auto Recycler	335	-	-	-	103	182	520
Heavy Industrial	124	-	-	-	148	290	1600
1: Claytor and Schueler (1996) 2: Average of Steuer et al. (1997), Bannerman (1993) and Waschbusch (2000) 3: Steuer et al. (1997)							

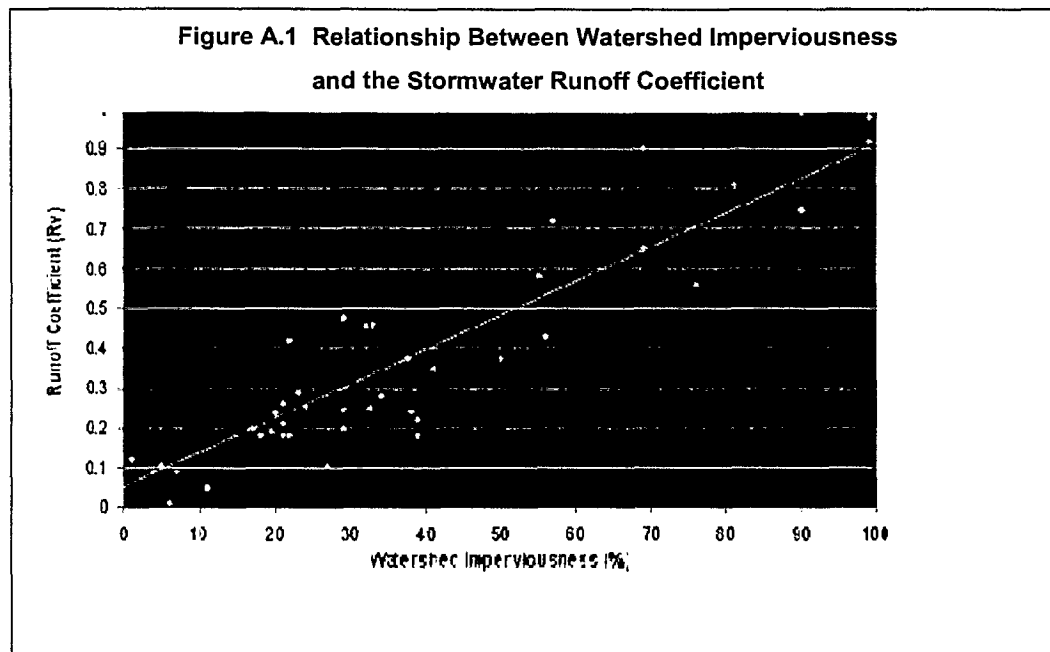

## A.2 Annual Runoff

The Simple Method calculates annual runoff as a product of annual runoff volume, and a runoff coefficient ( $R_v$ ). Runoff volume is calculated as:

$$R = P * P_j * R_v$$

Where:

- $R$  = Annual runoff (inches)
- $P$  = Annual rainfall (inches)
- $P_j$  = Fraction of annual rainfall events that produce runoff (usually 0.9)
- $R_v$  = Runoff coefficient

In the Simple Method, the runoff coefficient is calculated based on impervious cover in the subwatershed. This relationship is shown in Figure A.1. Although there is some scatter in the data, watershed imperviousness does appear to be a reasonable predictor of  $R_v$ .

The following equation represents the best fit line the dataset ( $N=47$ ,  $R^2=0.71$ ).

$$R_v = 0.05 + 0.9I_a$$

Where:  $I_a$  = Impervious fraction

### A.3 Impervious Cover Data

The Simple Method uses different impervious cover values for separate land uses within a subwatershed. Representative impervious cover data, are presented in Table A.3. These numbers are derived from a recent study conducted by the Center for Watershed Protection under a grant from the U.S. Environmental Protection Agency to update impervious cover estimates for a variety of land uses. (Cappiella and Brown, 2001). In addition, some jurisdictions may have detailed impervious cover information if they maintain a detailed land use/land cover GIS database.

Land Use Category	Mean Impervious Cover
Agriculture	2
Open Urban Land*	9
2 Acre Lot Residential	11
1 Acre Lot Residential	14
1/2 Acre Lot Residential	21
1/4Acre Lot Residential	28
1/8 Acre Lot Residential	33
Townhome Residential	41
Multifamily Residential	44
Institutional**	31-38%
Light Industrial	50-56%
Commercial	70-74%
<p>* Open urban land includes developed park land, recreation areas, golf courses, and cemeteries.</p> <p>** Institutional is defined as places of worship, schools, hospitals, government offices, and police and fire stations</p>	

### A.4 Limitations of the Simple Method

The Simple Method should provide reasonable estimates of changes in pollutant export resulting from urban development activities. However, several caveats should be kept in mind when applying this method.



The Simple Method is most appropriate for assessing and comparing the relative stormflow pollutant load changes of different land use and stormwater management scenarios. The Simple Method provides estimates of storm pollutant export that are probably close to the "true" but unknown value for a development site, catchment, or subwatershed. However, it is very important not to over emphasize the precision of the results obtained. For example, it would be inappropriate to use the Simple Method to evaluate relatively similar development scenarios (e.g., 34.3% versus 36.9% Impervious cover). The simple method provides a general planning estimate of likely storm pollutant export from areas at the scale of a development site, catchment or subwatershed. More sophisticated modeling may be needed to analyze larger and more complex drainages.

In addition, the Simple Method only estimates pollutant loads generated during storm events. It does not consider pollutants associated with baseflow volume. Typically, baseflow is negligible or non-existent at the scale of a single development site, and can be safely neglected, unless wastewater sources such as illicit connections and wastewater treatment plants are significant. However, catchments and subwatersheds do generate baseflow volume. Pollutant loads in baseflow are generally low and can seldom be distinguished from natural background levels (NVPDC, 1980). Consequently, baseflow pollutant loads normally constitute only a small fraction of the total pollutant load delivered from an urban area. Nevertheless, it is important to remember that the load estimates refer only to storm event derived loads and should not be confused with the total pollutant load from an area. This is particularly important when the development density of an area is low. For example, in a large low density residential subwatershed (Imp. Cover < 5%), as much as 75% of the annual runoff volume may occur as baseflow. In such a case, the annual baseflow nutrient load may be equivalent to the annual stormflow nutrient load.

**A.5 SMP Pollutant Removal**

The removal efficiencies of various SMP practices also help determine final annual pollutant loads. Table A.4 provides estimates of the average pollutant removal efficiency of the five SMP categories.

	TSS	TP	TN	Metals <sup>1</sup>	Bacteria
<b>Wet Ponds</b>	80	50 (51)	35 (33)	60 (62)	70
<b>Stormwater Wetlands</b>	80 <sup>2</sup> (76)	50 (49)	30	40 (42)	80 (78)
<b>Filtering Practices</b>	85 (86)	60 (59)	40 (38)	70 (69)	35 (37)
<b>Infiltration Practices<sup>4</sup></b>	90 <sup>3</sup> (95)	70	50 (51)	90 <sup>3</sup> (99)	90 <sup>4</sup>
<b>Water Quality Swales</b>	85 (84)	40 (39)	50 <sup>5</sup> (84)	70	0 (-25) <sup>6</sup>

1. Average of zinc and copper. Only zinc for infiltration
2. Many wetland practices in the database were poorly designed, and we consequently adjusted sediment removal upward.
3. It is assumed that no practice is greater than 90% efficient.
4. Data inferred from sediment removal.
5. Actual data is based on only two highly performing practices.
6. Assume 0 rather than a negative removal.

Note: Data in parentheses represent median pollutant removal data reported in the *National Pollutant Removal Database - Revised Edition* (Winer, 2000). These data were adjusted for convenience and to reflect biases in the data.

These efficiencies represent ideal pollutant removal rates that cannot be achieved at all sites, or at a watershed level. Typically, they need to be “discounted” to account for site constraints, and other factors that reduce practice efficiency. For example, the removal rate should be adjusted to reflect the fraction of runoff captured by a practice on an annual basis (90% if this guidance is followed). For more detail on how to apply these discounts, consult Caraco (2001).

One particularly important consideration is how to account for practices applied in series (e.g., two ponds applied in sequence). If the volume within the practices adds up to the total water quality volume, they are assumed to act as a single practice with that volume. Otherwise, total pollutant removal should be determined by the following equation:

$$R = L [(E_1) + (1 - E_1)E_2 + (1 - (E_1) + (1 - E_1)E_2)E_3 + \dots]$$

Where:

R = Pollutant Removal (lbs)

L = Annual Load from Simple Method (lbs.)

E<sub>i</sub> = Efficiency of the i<sup>th</sup> practice in a series

Another adjustment can be made to these removals to account for loss of effectiveness and “irreducible concentrations.” Evidence suggests that, at low concentrations, SMPs can no longer remove pollutants.

Table A.5 depicts typical outflow concentrations for various SMPs. Another simplified way to account for this phenomenon is to reduce the efficiency of a second or third practice in a series. For example, the removal efficiency could be cut in half to reflect inability to remove fine particles.

	TSS	TP	TN	Cu	Zn
<b>Wet Ponds</b>	17	0.11	1.3	5.0	30
<b>Wetlands</b>	22	0.20	1.7	7.0	31
<b>Filtering Practices</b>	11	0.10	1.12	10	21
<b>Infiltration Practices</b>	17 <sup>2</sup>	0.05 <sup>2</sup>	3.8 <sup>2</sup>	4.8 <sup>2</sup>	39 <sup>2</sup>
<b>Open Channel Practices</b>	14	0.19	1.12	10	53
1. Units for Zn and Cu are micrograms per liter 2. Data based on fewer than five data points					

#### References

- Bannerman, R., D. Owens, R. Dodds and N. Hornewer. 1993. "Sources of Pollutants in Wisconsin Stormwater." *Water Science and Technology*. 28(3-5): 241-259.
- Cappiella, K. and K. Brown. 2000. Derivations of Impervious Cover for Suburban Land Uses in the Chesapeake Bay Watershed. Prepared for the U.S. EPA Chesapeake Bay Program. Center for Watershed Protection, Ellicott City, MD.
- Caraco, D. 2001. The Watershed Treatment Model. Center for Watershed Protection. Ellicott City, MD. Prepared for: EPA Region V and Office of Wetlands, Oceans, and Watersheds. Washington, DC
- Claytor, R. and T. Schueler. 1996. *Design of Stormwater Filtering Systems*. Center for Watershed Protection. Ellicott City, MD.
- Northern Virginia Planning District Commission (NVPDC). 1980. *Guidebook for Screening Urban Nonpoint Pollution Management Strategies*. Northern Virginia Planning District Commission. Falls Church, VA.
- Schueler, T. 1999. Microbes and Urban Watersheds. *Watershed Protection Techniques*. 3(1): 551-596.
- Schueler, T. 1987. Controlling urban runoff: a practical manual for planning and designing urban BMPs. Metropolitan Washington Council of Governments. Washington, DC
- Smullen, J., and K. Cave. 1998. "Updating the U.S. Nationwide Urban Runoff Quality Database." *3<sup>rd</sup> International Conference on Diffuse Pollution*: August 31 - September 4, 1998. Scottish Environment Protection Agency. Edinburg, Scotland.

Steuer, J., W. Selbig, N. Hornewer, and J. Prey. 1997. "Sources of Contamination in an Urban Basin in Marquette, Michigan and an Analysis of Concentrations, Loads, and Data Quality." U.S. Geological Survey, *Water-Resources Investigations Report 97-4242*.

Waschbusch. 2000. Sources of phosphorus in stormwater and street dirt from two urban residential basins in Madison, Wisconsin, 1994-1995. In: National Conference on Tools for Urban Water Resource Management and Protection. US EPA February 2000: pp. 15-55.

Winer, R. 2000. National Pollutant Removal Database - Revised Edition. Center for Watershed Protection, Ellicott City, Maryland.

# Appendix B

New York State Stormwater Management Design Manual

R0080426

## Appendix B: Hydrologic Analysis Tools

This Appendix presents two hydrologic and hydraulic analysis tools that can be used to size stormwater management practices (SMPs). The first is the TR-55 (NRCS, 1986) "short-cut" sizing technique, used to size practices designed for extended detention, slightly modified to incorporate the small flows necessary to provide channel protection. The second is a method used to determine the peak flow from water quality storm events. (This is often important when the water quality storm is diverted to a water quality practice, with other larger events bypassed).

### B.1 Storage Volume Estimation

This section presents a modified version of the TR-55 short cut sizing approach. The method was modified by Harrington (1987), for applications where the peak discharge is very small compared with the uncontrolled discharge. This often occurs in the 1-year, 24-hour detention sizing.

Using TR-55 guidance (NRCS, 1986), the unit peak discharge ( $q_u$ ) can be determined based on the the Curve Number and Time of Concentration. Knowing  $q_0$  and  $T$  (extended detention time),  $q_0/q_1$  (peak outflow discharge/peak inflow discharge) can be estimated from Figure B.1.

Figure B.2 can also be used to estimate  $V_s/V_r$ . For a Type II or Type III rainfall distribution,  $V_s/V_r$  can also be calculated using the following equation:

$$V_s/V_r = 0.682 - 1.43 (q_0/q_1) + 1.64 (q_0/q_1)^2 - 0.804 (q_0/q_1)^3 \quad (2.1.16)$$

Where:

- $V_s$  = required storage volume (acre-feet)
- $V_r$  = runoff volume (acre-feet)
- $q_0$  = peak outflow discharge (cfs)
- $q_1$  = peak inflow discharge (cfs)

The required storage volume can then be calculated by:

$$V_s = \frac{(V_s/V_r)(Q_d)(A)}{12} \quad (2.1.17)$$

Where:  $V_s$  and  $V_r$  are defined above

- $Q_d$  = the post-developed runoff for the design storm (inches)
- $A$  = total drainage area (acres)

While the TR-55 short-cut method reports to incorporate multiple stage structures, experience has shown that an additional 10-15% storage is required when multiple levels of extended detention are provided.

Figure B.1 Detention Time vs. Discharge Ratios (Source: MDE, 2000)

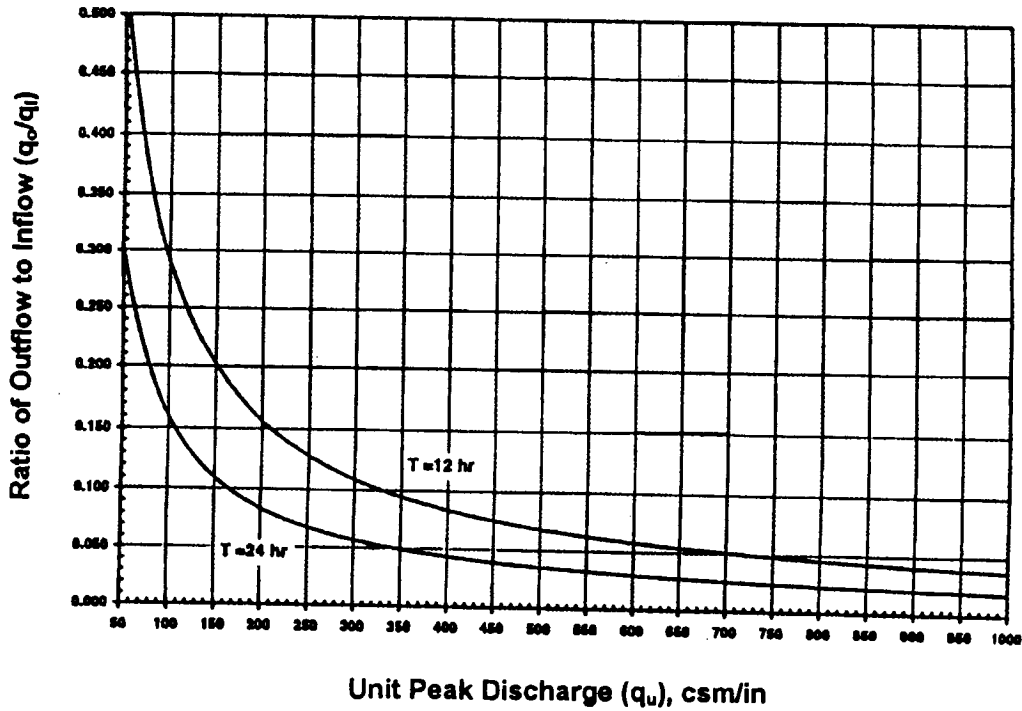
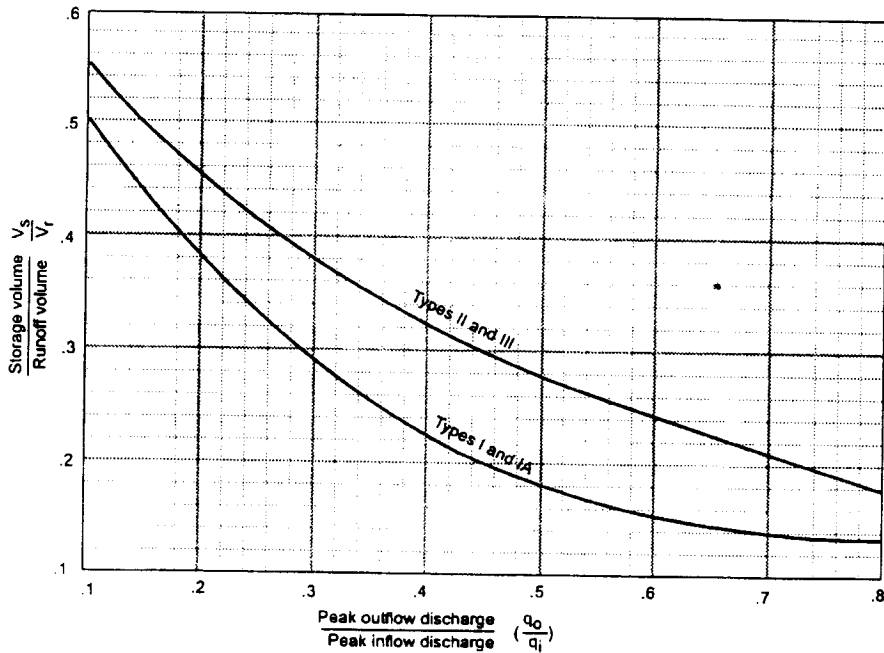

Figure B.2 Approximate Detention Basin Routing For Rainfall Types I, IA, II, and III (Source: NRCS, 1986)



## B.2 Water Quality Peak Flow Calculation

The peak rate of discharge for the water quality design storm is needed for the sizing of diversion structures for off-line practices such as sand filters. An arbitrary storm would need to be chosen using the Rational method, and conventional SCS methods have been found to underestimate the volume and rate of runoff for rainfall events less than 2". This discrepancy in estimating runoff and discharge rates can lead to situations where a significant amount of runoff by-passes the filtering treatment practice due to an inadequately sized diversion structure and leads to the design of undersized bypass channels.

The following procedure can be used to estimate peak discharges for small storm events. It relies on the Water Quality Volume and the simplified peak flow estimating method above. A brief description of the calculation procedure is presented below.

Using the water quality volume ( $WQ_v$ ), a corresponding Curve Number (CN) is computed utilizing the following equation:

$$CN = 1000/[10 + 5P + 10Q - 10(Q^2 + 1.25QP)^{1/2}]$$

Where

P = rainfall, in inches (use the 90% rainfall event from Figure 4.1 for the Water Quality Storm)

Q = runoff volume, in inches

Once a CN is computed, the time of concentration ( $t_c$ ) is computed using guidance provided in TR-55.

Using the computed CN,  $t_c$  and drainage area (A), in acres; the peak discharge ( $Q_p$ ) for the water quality storm event is computed (either Type II or Type III in the State of New York).

Read initial abstraction ( $I_a$ ), compute  $I_a/P$

Read the unit peak discharge ( $q_u$ ) for appropriate  $t_c$

Using the water quality volume ( $WQ_v$ ), compute the peak discharge ( $Q_p$ )

$$Q_p = q_u * A * WQ_v$$

where  $Q_p$  = the peak discharge, in cfs

$q_u$  = the unit peak discharge, in cfs/mi<sup>2</sup>/inch

A = drainage area, in square miles

$WQ_v$  = Water Quality Volume, in watershed inches



**References**

- Harrington, B.W. 1987. Design Procedures for Stormwater Management Extended Detention Structures. Report to Water Resources Administration. Maryland Department of Natural Resources. Annapolis, MD.
- Maryland Department of the Environment (MDE). 2000. Maryland Stormwater Design Manual. Baltimore, MD.
- Natural Resources Conservation Service (NRCS). 1986. Urban Hydrology for Small Watersheds. Technical Release No. 55. USDA. Washington D.C.

# Appendix C

New York State Stormwater Management Design Manual

R0080431

## Appendix C: Construction Standards and Specifications

### C.1 Pond Construction Standards/Specifications

These specifications are generally appropriate to all earthen ponds, and are adapted from NRCS Pond Code 378. Practitioners should always consult the New York State Department of Environmental Conservation – Dam Safety Division for the most recent guidance. All references to ASTM and AASHTO specifications apply to the most recent version.

#### **Site Preparation**

Areas designated for borrow areas, embankment, and structural works shall be cleared, grubbed and stripped of topsoil. All trees, vegetation, roots and other objectionable material shall be removed. Channel banks and sharp breaks shall be sloped to no steeper than 1:1. All trees shall be cleared and grubbed within 15 feet of the toe of the embankment.

Areas to be covered by the reservoir will be cleared of all trees, brush, logs, fences, rubbish and other objectionable material unless otherwise designated on the plans. Trees, brush, and stumps shall be cut approximately level with the ground surface. For dry stormwater management ponds, a minimum of a 25-foot radius around the outlet structure shall be cleared.

All cleared and grubbed material shall be disposed of outside and below the limits of the dam and reservoir as directed by the owner or his representative. When specified, a sufficient quantity of topsoil will be stockpiled in a suitable location for use on the embankment and other designated areas.

#### **Earth Fill**

**Material** - The fill material shall be taken from approved designated borrow areas. It shall be free of roots, stumps, wood, rubbish, stones greater than 6", frozen or other objectionable materials. Fill material for the center of the embankment, and cut off trench shall conform to Unified Soil Classification GC, SC, CH, or CL and must have at least 30% passing the #200 sieve. Consideration may be given to the use of other materials in the embankment if designed by a geotechnical engineer. Such special designs must have construction supervised by a geotechnical engineer.

Materials used in the outer shell of the embankment must have the capability to support vegetation of the quality required to prevent erosion of the embankment.

**Placement** - Areas on which fill is to be placed shall be scarified prior to placement of fill. Fill materials shall be placed in maximum 8 inch thick (before compaction) layers which are to be continuous over the entire length of the fill. The most permeable borrow material shall be placed in the downstream portions of the embankment. The principal spillway must be installed concurrently with fill placement and not excavated into the embankment.

**Compaction** - The movement of the hauling and spreading equipment over the fill shall be controlled so that the entire surface of each lift shall be traversed by not less than one tread track of heavy equipment or compaction shall be achieved by a minimum of four complete passes of a sheepsfoot, rubber tired or vibratory roller. Fill material shall contain sufficient moisture such that the required degree of compaction will be obtained with the equipment used. The fill material shall contain sufficient moisture so that if formed into a ball it will not crumble, yet not be so wet that water can be squeezed out.

When required by the reviewing agency the minimum required density shall not be less than 95% of maximum dry density with a moisture content within 2% of the optimum. Each layer of fill shall be compacted as necessary to obtain that density, and is to be certified by the Engineer at the time of construction. All compaction is to be determined by AASHTO Method T-99 (Standard Proctor).

**Cut Off Trench** - The cutoff trench shall be excavated into impervious material along or parallel to the centerline of the embankment as shown on the plans. The bottom width of the trench shall be governed by the equipment used for excavation, with the minimum width being four feet. The depth shall be at least four feet below existing grade or as shown on the plans. The side slopes of the trench shall be 1 to 1 or flatter. The backfill shall be compacted with construction equipment, rollers, or hand tampers to assure maximum density and minimum permeability.

**Embankment Core** - The core shall be parallel to the centerline of the embankment as shown on the plans. The top width of the core shall be a minimum of four feet. The height shall extend up to at least the 10 year water elevation or as shown on the plans. The side slopes shall be 1 to 1 or flatter. The core shall be compacted with construction equipment, rollers, or hand tampers to assure maximum density and minimum permeability. In addition, the core shall be placed concurrently with the outer shell of the embankment.

### **Structure Backfill**

Backfill adjacent to pipes or structures shall be of the type and quality conforming to that specified for the adjoining fill material. The fill shall be placed in horizontal layers not to exceed four inches in thickness and compacted by hand tampers or other manually directed compaction equipment. The material needs to fill completely all spaces under and adjacent to the pipe. At no time during the backfilling operation shall driven equipment be allowed to operate closer than four feet, measured horizontally, to any part of a structure. Under no circumstances shall equipment be driven over any part of a concrete structure or pipe, unless there is a compacted fill of 24" or greater over the structure or pipe.

Structure backfill may be flowable fill meeting the requirements of the New York State Department of Transportation. The mixture shall have a 100-200 psi; 28 day unconfined compressive strength. The flowable fill shall have a minimum pH of 4.0 and a minimum resistivity of 2,000 ohm-cm. Material shall be placed such that a minimum of 6" (measured perpendicular to the outside of the pipe) of flowable fill shall be under (bedding), over and, on the sides of the pipe. It only needs to extend up to the spring line for rigid conduits. Average slump of the fill shall be 7" to assure flowability of the material. Adequate measures shall be taken (sand bags, etc.) to prevent floating the pipe. When using flowable fill, all metal pipe shall be bituminous coated. Any adjoining soil fill shall be placed in horizontal layers not to exceed four inches in thickness and compacted by hand tampers or other manually directed compaction equipment. The material shall completely fill all voids adjacent to the flowable fill zone. At no time during the backfilling operation shall driven equipment be allowed to operate closer than four feet, measured horizontally, to any part of a structure. Under no circumstances shall equipment be driven over any part of a structure or pipe unless there is a compacted fill of 24" or greater over the structure or pipe. Backfill material outside the structural backfill (flowable fill) zone shall be of the type and quality conforming to that specified for the core of the embankment or other embankment materials.

### **Pipe Conduits**

All pipes shall be circular in cross section.

Corrugated Metal Pipe - All of the following criteria shall apply for corrugated metal pipe:

**Materials** - (Polymer Coated steel pipe) - Steel pipes with polymeric coatings shall have a minimum coating thickness of 0.01 inch (10 mil) on both sides of the pipe. This pipe and its appurtenances shall conform to the requirements of AASHTO Specifications M-245 & M-246 with watertight coupling bands or flanges.

**Materials** - (Aluminum Coated Steel Pipe) - This pipe and its appurtenances shall conform to the requirements of AASHTO Specification M-274 with watertight coupling bands or flanges. Aluminum Coated Steel Pipe, when used with flowable fill or when soil and/or water conditions warrant the need for increased durability, shall be fully bituminous coated per requirements of AASHTO Specification M-190 Type A. Any aluminum coating damaged or otherwise removed shall be replaced with cold applied bituminous coating compound. Aluminum surfaces that are to be in contact with concrete shall be painted with one coat of zinc chromate primer or two coats of asphalt.

**Materials** - (Aluminum Pipe) - This pipe and its appurtenances shall conform to the requirements of AASHTO Specification M-196 or M-211 with watertight coupling bands or flanges. Aluminum Pipe, when used with flowable fill or when soil and/or water conditions warrant for increased durability, shall be fully bituminous coated per requirements of AASHTO Specification M-190 Type A. Aluminum surfaces that are to be in contact with concrete shall be painted with one coat of zinc chromate primer or two coats of asphalt. Hot dip galvanized bolts may be used for connections. The pH of the surrounding soils shall be between 4 and 9.

Coupling bands, anti-seep collars, end sections, etc., must be composed of the same material and coatings as the pipe. Metals must be insulated from dissimilar materials with use of rubber or plastic insulating materials at least 24 mils in thickness.

Connections - All connections with pipes must be completely watertight. The drain pipe or barrel connection to the riser shall be welded all around when the pipe and riser are metal. Anti-seep collars shall be connected to the pipe in such a manner as to be completely watertight. Dimple bands are not considered to be watertight. All connections shall use a rubber or neoprene gasket when joining pipe sections. The end of each pipe shall be re-rolled an adequate number of corrugations to accommodate the bandwidth. The following type connections are acceptable for pipes less than 24 inches in diameter: flanges on both ends of the pipe with a circular 3/8 inch closed cell neoprene gasket, pre-punched to the flange bolt circle, sandwiched between adjacent flanges; a 12-inch wide standard lap type band with 12-inch wide by 3/8-inch thick closed cell circular neoprene gasket; and a 12-inch wide hugger type band with o-ring gaskets having a minimum diameter of 1/2 inch greater than the corrugation depth. Pipes 24 inches in diameter and larger shall be connected by a 24 inch long annular corrugated band using a minimum of 4 (four) rods and lugs, 2 on each connecting pipe end. A 24-inch wide by 3/8-inch thick closed cell circular neoprene gasket will be installed with 12 inches on the end of each pipe. Flanged joints with 3/8 inch closed cell gaskets the full width of the flange is also acceptable.

Helically corrugated pipe shall have either continuously welded seams or have lock seams with internal caulking or a neoprene bead.

**Bedding** - The pipe shall be firmly and uniformly bedded throughout its entire length. Where rock or soft, spongy or other unstable soil is encountered, all such material shall be removed and replaced with suitable earth compacted to provide adequate support.

Backfilling shall conform to Structure Backfill requirements.

Other details (anti-seep collars, valves, etc.) shall be as shown on the drawings.

**Reinforced Concrete Pipe** - All of the following criteria shall apply for reinforced concrete pipe:

**Materials** - Reinforced concrete pipe shall have bell and spigot joints with rubber gaskets and shall equal or exceed ASTM C-361.

**Bedding** - Reinforced concrete pipe conduits shall be laid in a concrete bedding / cradle for their entire length. This bedding / cradle shall consist of high slump concrete placed under the pipe and up the sides of the pipe at least 50% of its outside diameter with a minimum thickness of 6 inches. Where a concrete cradle is not needed for structural reasons, flowable fill may be used as described in the Structure Backfill section of this standard. Gravel bedding is not permitted.

**Laying pipe** - Bell and spigot pipe shall be placed with the bell end upstream. Joints shall be made in accordance with recommendations of the manufacturer of the material. After the joints are sealed for the entire line, the bedding shall be placed so that all spaces under the pipe are filled. Care shall be exercised to prevent any deviation from the original line and grade of the pipe. The first joint must be located within 4 feet from the riser.

Backfilling shall conform to Structure Backfill requirements.

Other details (anti-seep collars, valves, etc.) shall be as shown on the drawings.

**Plastic Pipe** - The following criteria shall apply for plastic pipe:

1. **Materials** - PVC pipe shall be PVC-1120 or PVC-1220 conforming to ASTM D-1785 or ASTM D-2241. Corrugated High Density Polyethylene (HDPE) pipe, couplings and fittings shall conform to the following: 4" through 10" pipe shall meet the requirements of AASHTO M252 Type S, and 12" through 24" pipe shall meet the requirements of AASHTO M294 Type S.
2. Joints and connections to anti-seep collars shall be completely watertight.
3. **Bedding** -The pipe shall be firmly and uniformly bedded throughout its entire length. Where rock or soft, spongy or other unstable soil is encountered, all such material shall be removed and replaced with suitable earth compacted to provide adequate support.
4. Backfilling shall conform to Structure Backfill requirements.
5. Other details (anti-seep collars, valves, etc.) shall be as shown on the drawings.

**Drainage Diaphragms** - When a drainage diaphragm is used, a registered professional engineer will supervise the design and construction inspection.

### **Concrete**

Concrete shall meet the requirements of the New York State Department of Transportation.

**Rock Riprap**

Rock riprap shall meet the requirements of the New York State Department of Transportation.

Geotextile shall be placed under all riprap and shall meet the requirements of the New York State Department of Transportation.

**Care of Water During Construction**

All work on permanent structures shall be carried out in areas free from water. The Contractor shall construct and maintain all temporary dikes, levees, cofferdams, drainage channels, and stream diversions necessary to protect the areas to be occupied by the permanent works. The contractor shall also furnish, install, operate, and maintain all necessary pumping and other equipment required for removal of water from various parts of the work and for maintaining the excavations, foundation, and other parts of the work free from water as required or directed by the engineer for constructing each part of the work. After having served their purpose, all temporary protective works shall be removed or leveled and graded to the extent required to prevent obstruction in any degree whatsoever of the flow of water to the spillway or outlet works and so as not to interfere in any way with the operation or maintenance of the structure. Stream diversions shall be maintained until the full flow can be passed through the permanent works. The removal of water from the required excavation and the foundation shall be accomplished in a manner and to the extent that will maintain stability of the excavated slopes and bottom required excavations and will allow satisfactory performance of all construction operations. During the placing and compacting of material in required excavations, the water level at the locations being refilled shall be maintained below the bottom of the excavation.

**Stabilization**

All borrow areas shall be graded to provide proper drainage and left in a slightly condition. All exposed surfaces of the embankment, spillway, spoil and borrow areas, and berms shall be stabilized by seeding, liming, fertilizing and mulching in accordance with local Natural Resources Conservation Service Standards and Specifications.

**Erosion and Sediment Control**

Construction operations will be carried out in such a manner that erosion will be controlled and water and air pollution minimized. Federal, State and local laws concerning pollution abatement will be followed. Construction plans shall detail erosion and sediment control measures.

**Operation and Maintenance**

An operation and maintenance plan in accordance with Local or State Regulations will be prepared for all ponds. As a minimum, a dam inspection checklist shall be included as part of the operation and maintenance plan and performed at least annually. Written records of maintenance and major repairs need to be retained in a file.

**Supplemental Stormwater Pond and Wetland Specifications**

1. It is preferred to use the same material in the embankment as is being installed for the core trench. If this is not possible, a dam core with a shell may be used. The cross-section of the stormwater facility should show the limits of the dam core (up to the 10-year water surface elevation) as well as the acceptable materials for the shell. The shape of the dam core and the material to be used in the shell should be provided by the geotechnical engineer.

2. If the compaction tests for the remainder of the site improvements is using Modified Proctor (AASHTO T-180), then to maintain consistency on-site, modified proctor may be used in lieu of standard proctor (AASHTO T-99) for checking embankment compaction. The minimum required density using the modified proctor test method shall be at least 92% of maximum dry density with a moisture content of 2% of the optimum.
3. For all stormwater management facilities, a geotechnical engineer must be present to verify compaction in accordance with the selected test method. This information needs to be provided in a report to the design engineer, so that as-built certification of the facility can be made.
4. A 4-inch layer of topsoil shall be placed on all disturbed areas of the dam embankment. Seeding, liming, fertilizing, mulching, etc. shall be in accordance with NRCS Soil Standards and Specifications or New York State Standards and Specifications for Soil Erosion and Sediment Control. The purpose of the topsoil is to establish a good growth of grass which is not always possible with some of the materials that may be placed for the embankment fill.
5. Filter fabric placed beneath the rip-rap shall meet state or local department of transportation requirements for a Class "C" filter fabric. Some acceptable filter fabrics that meet the Class "C" criteria include:

Mirafi 180-N

Amoco 4552

Webtec N07

Geolon N70

Carthage FX-70S

This is only a partial listing of available filter fabrics based on information provided by the manufacturers to the 1997 Specifier's Guide dated December 1996. It is the responsibility of the engineer to verify the adequacy of the material, as there are changes in the manufacturing process and the type of fabric used, which may affect the continued acceptance.

6. The design engineer and geotechnical engineer should make the determination that the settlement of the pond will not cause excessive joint extension. For further information on joint extension analysis, see NRCS Publication TR-18.
7. Fill placement shall not exceed a maximum of 8-inch lift thickness. Each lift shall be continuous for the entire length of the embankment.
8. The embankment fill **shall not** be placed higher than the centerline of the principle spillway until after the principle spillway has been installed.
9. The side slopes of a cut to repair a dam, install a principle spillway for an excavated pond, or other repair work, shall be stepped and on an average slope of 2:1 or flatter.



**C.2 Construction Specifications for Infiltration Practices****Infiltration Trench General Notes and Specifications**

The infiltration trench systems may not receive run-off until the entire contributing drainage area to the infiltration system has received final stabilization.

1. Heavy equipment and traffic shall be restricted from traveling over the infiltration trench to minimize compaction of the soil.
2. Excavate the infiltration trench to the design dimensions. Excavated materials shall be placed away from the trench sides to enhance trench wall stability. Large tree roots must be trimmed flush with the trench sides in order to prevent fabric puncturing or tearing of the filter fabric during subsequent installation procedures. The side walls of the trench shall be roughened where sheared and sealed by heavy equipment.
3. A Class "C" geotextile or better shall interface between the trench side walls and between the stone reservoir and gravel filter layers. A partial list of non-woven filter fabrics that meet the Class "C" criteria is contained below. Any alternative filter fabric must be approved by the local municipality prior to installation.

Mirafi 180-N  
Amoco 4552  
WEBTEC N70  
GEOLON N70  
Carthage FX-80S

The width of the geotextile must include sufficient material to conform to trench perimeter irregularities and for a 6-inch minimum top overlap. The filter fabric shall be tucked under the sand layer on the bottom of the infiltration trench for a distance of 6 to 12 inches. Stones or other anchoring objects should be placed on the fabric at the edge of the trench to keep the trench open during windy periods. When overlaps are required between rolls, the uphill roll should lap a minimum of 2 feet over the downhill roll in order to provide a shingled effect.

4. A 6 inch sand layer may be placed on the bottom of the infiltration trench in lieu of filter fabric, and shall be compacted using plate compactors. The sand for the infiltration trench shall be washed and meet AASHTO Std. M-43, Size No. 9 or No. 10. Any alternative sand gradation must be approved by the Engineer or the local municipality.
5. The stone aggregate should be placed in lifts and compacted using plate compactors. A maximum loose lift thickness of 12 inches is recommended. Gravel filling (rounded bank run gravel is preferred) for the infiltration trench shall be washed and meet one of the following: AASHTO Std. M-43; Size No. 2 or No. 3.
6. Following the stone aggregate placement, the filter fabric shall be folded over the stone aggregate to form a 6-inch minimum longitudinal lap. The desired fill soil or stone aggregate shall be placed over the lap at sufficient intervals to maintain the lap during subsequent backfilling.
7. Care shall be exercised to prevent natural or fill soils from intermixing with the stone aggregate. All contaminated stone aggregate shall be removed and replaced with uncontaminated stone aggregate.

8. Voids can be created between the fabric and the excavation sides and shall be avoided. Removing boulders or other obstacles from the trench walls is one source of such voids, therefore, natural soils should be placed in these voids at the most convenient time during construction to ensure fabric conformity to the excavation sides.
9. Vertically excavated walls may be difficult to maintain in areas where soil moisture is high or where soft cohesive or cohesionless soils are predominate. These conditions may require laying back of the side slopes to maintain stability.
10. PVC distribution pipes shall be Schedule 40 and meet ASTM Std. D 1784. All fittings and perforations (1/2 inch in diameter) shall meet ASTM Std. D 2729. A perforated pipe shall be provided only within the infiltration trench and shall terminate 1 foot short of the infiltration trench wall. The end of the PVC pipe shall be capped.
11. Corrugated metal distribution pipes shall conform to AASHTO Std. M-36, and shall be aluminized in accordance with AASHTO Std. M-274. Coat aluminized pipe in contact with concrete with an inert compound capable of effecting isolation of the deleterious effect of the aluminum on the concrete. Perforated distribution pipe shall be provided only within the infiltration trench and shall terminate 1 foot short of the infiltration trench wall. An aluminized metal plate shall be welded to the end of the pipe.
12. The observation well is to consist of 6-inch diameter PVC Schedule 40 pipe (ASTM Std. D 1784) with a cap set 6 inches above ground level and is to be located near the longitudinal center of the infiltration trench. Preferably the observation well will not be located in vehicular traffic areas. The pipe shall have a plastic collar with ribs to prevent rotation when removing cap. The screw top lid shall be a "Panella" type cleanout with a locking mechanism or special bolt to discourage vandalism. A perforated (1/2 inch in diameter) PVC Schedule 40 pipe shall be provided and placed vertically within the gravel portion of the infiltration trench and a cap provided at the bottom of the pipe. The bottom of the cap shall rest on the infiltration trench bottom.
13. If a distribution structure with a wet well is used, a 4-inch PVC drain pipe shall be provided at opposite ends of the infiltration trench distribution structure. Two (2) cubic feet of porous backfill meeting AASHTO Std. M-43 Size No. 57 shall be provided at each drain.
14. If a distribution structure is used, the manhole cover shall be bolted to the frame.

NOTE: PVC pipe with a wall thickness classification of SDR-35 meeting ASTM standard D3034 is an acceptable substitution for PVC Schedule 40 pipe.

#### **Infiltration Basins Notes and Specifications**

1. The sequence of various phases of basin construction shall be coordinated with the overall project construction schedule. A program should schedule rough excavation of the basin (to not less than 2' from final grade) with the rough grading phase of the project to permit use of the material as fill in earthwork areas. The partially excavated basin, however, **cannot** serve as a sedimentation basin.

Specifications for basin construction should state: (1) the earliest point in progress when storm drainage may be directed to the basin, and (2) the means by which this delay in use is to be

accomplished. Due to the wide variety of conditions encountered among projects, each should be separately evaluated in order to postpone use as long as is reasonably possible.

2. Initial basin excavation should be carried to within 2 feet of the final elevation of the basin floor. Final excavation to the finished grade should be deferred until all disturbed areas on the watershed have been stabilized or protected. The final phase excavation should remove all accumulated sediment. Relatively light tracked equipment is recommended for this operation to avoid compaction of the basin floor. After the final grading is completed, the basin should retain a highly porous surface texture.
3. Infiltration basins may be lined with a 6- to 12-inch layer of filter material such as coarse sand (AASHTO Std. M-43, Sizes 9 or 10) to help prevent the buildup of impervious deposits on the soil surface. The filter layer can be replaced or cleaned when it becomes clogged. When a 6-inch layer of coarse organic material is specified for discing (such as hulls, leaves, stems, etc.) or spading into the basin floor to increase the permeability of the soils, the basin floor should be soaked or inundated for a brief period, then allowed to dry subsequent to this operation. This induces the organic material to decay rapidly, loosening the upper soil layer.
4. Establishing dense vegetation on the basin side slopes and floor is recommended. A dense vegetative stand will not only prevent erosion and sloughing, but will also provide a natural means of maintaining relatively high infiltration rates. Erosion protection of inflow points to the basin shall also be provided.
5. Selection of suitable vegetative materials for the side slope and all other areas to be stabilized with vegetation and application of required lime, fertilizer, etc. shall be done in accordance with the NRCS Standards and Specifications or your local Standards and Specifications for Soil Erosion and Sediment Control.
6. Grasses of the fescue family are recommended for seeding primarily due to their adaptability to dry sandy soils, drought resistance, hardiness, and ability to withstand brief inundations. The use of fescues will also permit long intervals between mowings. This is important due to the relatively steep slopes which make mowing difficult. Mowing twice a year, once in June and again in September, is generally satisfactory.

**C.3 Construction Specifications for Bioretention, Sand Filters and Open Channels****Sand Filter Specifications****Material Specifications for Sand Filters**

The allowable materials for sand filter construction are detailed in Table 1.

**Sand Filter Testing Specifications**

Underground sand filters, facilities within sensitive groundwater aquifers, and filters designed to serve urban hot spots are to be tested for water tightness prior to placement of filter layers. Entrances and exits should be plugged and the system completely filled with water to demonstrate water tightness.

All overflow weirs, multiple orifices and flow distribution slots to be field-tested as to verify adequate distribution of flows.

**Sand Filter Construction Specifications**

Provide sufficient maintenance access; 12-foot-wide road with legally recorded easement. Vegetated access slopes to be a maximum of 10%; gravel slopes to 15%; paved slopes to 25%.

*Absolutely no runoff* is to enter the filter until all contributing drainage areas have been stabilized.

Surface of filter bed to be *completely level*.

All sand filters should be clearly delineated with signs so that they may be located when maintenance is due.

Surface sand filters shall be planted with appropriate grasses as specified in your local NRCS Standards and Specifications guidance.

Pocket sand filters (and residential bioretention facilities treating areas larger than an acre) shall be sized with an ornamental stone window covering approximately 10% of the filter area. This surface shall be 2" to 5" size stone on top of a pea gravel layer (3/4 inch stone) approximately 4 to 6" of pea gravel.

**Specifications Pertaining to Underground Sand Filters**

Provide manhole and/or grates to all underground and below grade structures. Manholes shall be in compliance with standard specifications for each jurisdiction but diameters should be 30" minimum (to comply with OSHA confined space requirements) but not too heavy to lift. Aluminum and steel louvered doors are also acceptable. Ten-inch long (minimum) manhole steps (12" o.c.) shall be cast in place or drilled and mortared into the wall below each manhole. A 5" minimum height clearance (from the top of the sand layer to the bottom of the slab) is required for all permanent underground structures. Lift rings are to be supplied to remove/replace top slabs. Manholes may need to be grated to allow for proper ventilation; if required, place manholes *away* from areas of heavy pedestrian traffic.

Underground sand filters shall be constructed with a dewatering gate valve located just above the top of the filter bed should the bed clog.

Underground sand beds shall be protected from trash accumulation by a wide mesh geotextile screen to be placed on the surface of the sand bed; screen is to be rolled up, removed, cleaned and re-installed during maintenance operations.

Table C-1 Sand Filter Material Specifications

Parameter	Specification	Size	Notes
Sand	Clean AASHTO M-6 or ASTM C-33 concrete sand	0.02" to 0.04"	Sand substitutions such as Diabase and Graystone #10 are not acceptable. No calcium carbonated or dolomitic sand substitutions are acceptable. "Rock dust" cannot be substituted for sand.
Peat	Ash content: < 15% PH range: 5.2 to 4.9 Loose bulk density 0.12 to 0.15 g/cc	n/a	The material must be Reed-Sedge Hemic Peat, shredded, uncompacted, uniform, and clean.
Underdrain Gravel	AASHTO M-43 No. 67	0.25" to 0.75"	
Geotextile Fabric (if required)	ASTM D-751 (puncture strength - 125 lb.) ASTM D-1117 (Mullen Burst Strength - 400 psi) ASTM D-1682 (Tensile Strength - 300 lb.)	0.08" thick equivalent opening size of #80 sieve	Must maintain 125 gpm per sq. ft. flow rate. Note: a 4" pea gravel layer may be substituted for geotextiles meant to separate sand filter layers.
Impermeable Liner (if required)	ASTM D 751 (thickness) ASTM D 412 (tensile strength 1,100 lb., elongation 200%) ASTM D 624 (Tear resistance - 150 lb./in) ASTM D 471 (water adsorption: +8 to -2% mass)	30mil thickness	Liner to be ultraviolet resistant. A geotextile fabric should be used to protect the liner from puncture.
Underdrain Piping	ASTM D-1785 or AASHTO M-278	6" rigid schedule 40 PVC	3/8" perf. 6" on center, 4 holes per row; minimum of 3" of gravel over pipes; not necessary underneath pipes
Concrete (Cast-in-place)	See local DOT Standards and Specs. f=c = 3500 psi, normal weight, air-entrained; re-inforcing to meet ASTM 615-60	n/a	on-site testing of poured-in-place concrete required: 28 day strength and slump test; all concrete design (cast-in-place or pre-cast) <i>not using previously approved State or local standards</i> requires design drawings sealed and approved by a licensed professional structural engineer.
Concrete (pre-cast)	per pre-cast manufacturer	n/a	SEE ABOVE NOTE
Non-rebar steel	ASTM A-36	n/a	structural steel to be hot-dipped galvanized ASTM A123

R0080443

## Specifications for Bioretention

### Material Specifications

The allowable materials to be used in bioretention area are detailed in Table G.2.

### Planting Soil

The soil shall be a uniform mix, free of stones, stumps, roots or other similar objects larger than two inches. No other materials or substances shall be mixed or dumped within the bioretention area that may be harmful to plant growth, or prove a hindrance to the planting or maintenance operations. The planting soil shall be free of noxious weeds.

The planting soil shall be tested and shall meet the following criteria:

pH range	5.2 - 7.0
organic matter	1.5 - 4%
magnesium	35 lb./ac
phosphorus P <sub>2</sub> O <sub>5</sub>	75 lb./ac
potassium K <sub>2</sub> O	85 lb./ac
soluble salts	not to exceed 500 ppm

All bioretention areas shall have a minimum of one test. Each test shall consist of both the standard soil test for pH, phosphorus, and potassium and additional tests of organic matter, and soluble salts. A textural analysis is required from the site stockpiled topsoil. If topsoil is imported, then a texture analysis shall be performed for each location where the top soil was excavated.

Since different labs calibrate their testing equipment differently, all testing results shall come from the same testing facility.

Should the pH fall out of the acceptable range, it may be modified (higher) with lime or (lower) with iron sulfate plus sulfur.

### Compaction

It is very important to minimize compaction of both the base of the bioretention area and the required backfill. When possible, use excavation hoes to remove original soil. If bioretention areas are excavated using a loader, the contractor should use wide track or marsh track equipment, or light equipment with turf type tires. Use of equipment with narrow tracks or narrow tires, rubber tires with large lugs, or high pressure tires will cause excessive compaction resulting in reduced infiltration rates and storage volumes and is not acceptable. Compaction will significantly contribute to design failure.

Compaction can be alleviated at the base of the bioretention facility by using a primary tilling operation such as a chisel plow, ripper, or subsoiler. These tilling operations are to refracture the soil profile through the 12 inch compaction zone. Substitute methods must be approved by the engineer. Rototillers typically do not till deep enough to reduce the effects of compaction from heavy equipment.

Rototill 2 to 3 inches of sand into the base of the bioretention facility before back filling the required sand layer. Pump any ponded water before preparing (rototilling) base.

When back filling the topsoil over the sand layer, first place 3 to 4 inches of topsoil over the sand, then rototill the sand/topsoil to create a gradation zone. Backfill the remainder of the topsoil to final grade.

When back filling the bioretention facility, place soil in lifts 12" or greater. Do not use heavy equipment within the bioretention basin. Heavy equipment can be used around the perimeter of the basin to supply soils and sand. Grade bioretention materials by hand or with light equipment such as a compact loader or a dozer/loader with marsh tracks.

### **Plant Installation**

Mulch around individual plants only. Shredded hardwood mulch is the only accepted mulch. Pine mulch and wood chips will float and move to the perimeter of the bioretention area during a storm event and are not acceptable. Shredded mulch must be well aged (6 to 12 months) for acceptance.

The plant root ball should be planted so 1/8<sup>th</sup> of the ball is above final grade surface.

Root stock of the plant material shall be kept moist during transport and on-site storage. The diameter of the planting pit shall be at least six inches larger than the diameter of the planting ball. Set and maintain the plant straight during the entire planting process. Thoroughly water ground bed cover after installation.

Trees shall be braced using 2" X 2" stakes only as necessary and for the first growing season only. Stakes are to be equally spaced on the outside of the tree ball.

Grasses and legume seed shall be tilled into the soil to a depth of at least one inch. Grass and legume plugs shall be planted following the non-grass ground cover planting specifications.

The topsoil specifications provide enough organic material to adequately supply nutrients from natural cycling. The primary function of the bioretention structure is to improve water quality. Adding fertilizers defeats, or at a minimum, impedes this goal. Only add fertilizer if wood chips or mulch is used to amend the soil. Rototill urea fertilizer at a rate of 2 pounds per 1000 square feet.

### **Underdrains**

Under drains to be placed on a 3'-0" wide section of filter cloth. Pipe is placed next, followed by the gravel bedding. The ends of under drain pipes not terminating in an observation well shall be capped.

The main collector pipe for underdrain systems shall be constructed at a minimum slope of 0.5%. Observation wells and/or clean-out pipes must be provided (one minimum per every 1000 square feet of surface area).

### **Miscellaneous**

The bioretention facility may not be constructed until all contributing drainage area has been stabilized.



Table C.2 Materials Specifications for Bioretention

Parameter	Specification	Size	Notes
Plantings	see your local NRCS Standards and Specifications guidance.	n/a	plantings are site-specific
Planting Soil [4= deep]	sand 35 - 60% silt 30 - 55% clay 10 - 25%	n/a	USDA soil types loamy sand, sandy loam or loam
Mulch	shredded hardwood		aged 6 months, minimum
pea gravel diaphragm and curtain drain	pea gravel: ASTM D 448  ornamental stone: washed cobbles	pea gravel: No. 6 stone: 2" to 5"	
Geotextile	Class "C" apparent opening size (ASTM-D-4751) grab tensile strength (ASTM-D-4632) burst strength (ASTM-D-4833)	n/a	for use as necessary beneath underdrains only
underdrain gravel	AASHTO M-43. No. 67.	0.25" to 0.75"	
underdrain piping	ASTM D 1785 or AASHTO M-278	6" rigid schedule 40 PVC	3/8" perf. @ 6" on center, 4 holes per row; minimum of 3" of gravel over pipes; not necessary underneath pipes
poured in place concrete (if required)	See local DOT Standards and Specs.; f=c = 3500 psi. @ 28 days, normal weight, air-entrained; re-inforcing to meet ASTM 615-60	n/a	on-site testing of poured-in-place concrete required: 28 day strength and slump test; all concrete design (cast-in-place or pre-cast) <i>not using previously approved State or local standards</i> requires design drawings sealed and approved by a licensed professional structural engineer.
sand [1= deep]	AASHTO M-6 or ASTM C-33	0.02" to 0.04"	Sand substitutions such as Diabase and Graystone #10 are not acceptable. No calcium carbonated or dolomitic sand substitutions are acceptable. No "rock dust" can be used for sand.

### Specifications for Open Channels and Filter Strips

#### Material Specifications

The recommended construction materials for open channels and filter strips are detailed in Table G.3.

#### Dry Swales

Roto-till soil/gravel interface approximately 6" to avoid a sharp soil/gravel interface.

Permeable soil mixture (20" to 30" deep) should meet the bioretention planting soil specifications.

Check dams, if required, shall be placed as specified.

System to have 6" of freeboard, minimum.

Side slopes to be 3:1 minimum; (4:1 or greater preferred).

No gravel or perforated pipe is to be placed under driveways.

Bottom of facility to be above the seasonably high water table.

Seed with flood/drought resistant grasses; see your local NRCS Standards and Specifications guidance.

Longitudinal slope to be 1 to 2%, maximum [up to 5% with check dams].

Bottom width to be 8' = maximum to avoid braiding; larger widths may be used if proper berming is supplied.  
Width to be 2' = minimum.

#### Wet Swales

Follow above information for dry swales, with the following exceptions: the seasonally high water table may inundate the swale; but not above the design bottom of the channel [NOTE: if the water table is stable within the channel; the WQv storage may start at this point]

Excavate into undisturbed soils; do not use an underdrain system.

#### Filter Strips

Construct pea gravel diaphragms 12" wide, minimum, and 24" deep minimum.

Pervious berms to be a sand/gravel mix (35-60% sand, 30-55% silt, and 10-25% gravel). Berms to have overflow weirs with 6 inch minimum available head.

Slope range to be 2% minimum to 6% maximum.

**Table C.3 Open Vegetated Swale and Filter Strip Materials Specifications**

Parameter	Specification	Size	Notes
Dry swale soil	USCS; ML, SM, SC	n/a	soil with a higher percent organic content is preferred
Dry Swale sand	ASTM C-33 fine aggregate concrete sand	0.02" to 0.04"	
Check Dam (pressure treated)	AWPA Standard C6	6" by 6" or 8" by 8"	<i>do not</i> coat with creosote; embed at least 3" into side slopes
Check Dam (natural wood)	Black Locust, Red Mulberry, Cedars, Catalpa, White Oak, Chestnut Oak, Black Walnut	6" to 12" diameter; notch as necessary	<i>do not</i> use the following, as these species have a predisposition towards rot: Ash, Beech, Birch, Elm, Hackberry, hemlock, Hickories, Maples, Red and Black Oak, Pines, Poplar, Spruce, Sweetgum, Willow
Filter Strip sand/gravel pervious berm	sand: per dry swale sand gravel; AASHTO M-43 No. 57	sand: 0.02" to 0.04" gravel: 2" to 1"	mix with approximately 25% loan soil to support grass cover crop; see Bioretention planting soil notes for more detail.
pea gravel diaphragm and curtain drain	ASTM D 448	varies (No. 6) or (1/8" to 3/8")	use clean bank-run gravel
under drain gravel	AASHTO M-43 No. 67	0.25" to 0.75"	
under drain	ASTM D -1785 or AASHTO M-278	6" rigid Schedule 40 PVC	3/8" perf. @ 6" o.c.; 4 holes per row
Geotextile	See local DOT Standards and Specs	n/a	
rip rap	per local DOT criteria	size per New York State DOT requirements based on 10-year design flows	

# Appendix D

## Appendix D: Infiltration Testing Requirements

### General Notes Pertinent to All Testing

1. For infiltration practices, a minimum field infiltration rate ( $f_c$ ) of 0.5 inches per hour is required; areas yielding a lower rate preclude these practices. If the minimum  $f_c$  exceeds two inches per hour, half of the  $WQ_v$  must be treated by an upstream SMP that does allow infiltration. For F-1 and F-6 practices, no minimum infiltration rate is required if these facilities are designed with a “day-lighting” underdrain system; otherwise these facilities require a 0.5 inch per hour rate.
2. Number of required borings is based on the size of the proposed facility. Testing is done in two phases, (1) Initial Feasibility, and (2) Concept Design Testing.
3. Testing is to be conducted by a qualified professional. This professional shall either be a registered professional engineer in the State of New York, a soils scientist or geologist also licensed in the State of New York.

### Initial Feasibility Testing

Feasibility testing is conducted to determine whether full-scale testing is necessary, and is meant to screen unsuitable sites, and reduce testing costs. A soil boring is not required at this stage. However, a designer or landowner may opt to engage Concept Design Borings per Table H-1 at his or her discretion, without feasibility testing.

Initial testing involves either one field test per facility, regardless of type or size, or previous testing data, such as the following:

- \* septic percolation testing on-site, within 200 feet of the proposed SMP location, and on the same contour [can establish initial rate, water table and/or depth to bedrock]
- \* previous written geotechnical reporting on the site location as prepared by a qualified geotechnical consultant
- \* NRCS County Soil Mapping *showing an unsuitable soil group* such as a hydrologic group “D” soil in a low-lying area, or a Marlboro Clay

If the results of initial feasibility testing as determined by a qualified professional show that an infiltration rate of greater than 0.5 inches per hour is probable, then the number of *concept design test* pits shall be per the following table. An encased soil boring may be substituted for a test pit, if desired.

**Table D-1 Infiltration Testing Summary Table**

<b>Type of Facility</b>	<b>Initial Feasibility Testing</b>	<b>Concept Design Testing (initial testing yields a rate greater than 0.5"/hr)</b>	<b>Concept Design Testing (initial testing yields a rate lower than 0.5"/hr)</b>
I-1 (trench)	1 field percolation test, test pit not required	1 infiltration test and 1 test pit per 50' of trench	not acceptable practice
I-2 (basin)	1 field percolation test, test pit not required	1 infiltration test* and 1 test pit per 200 sf of basin area	not acceptable practice
F-1 (sand filter)	1 field percolation test, test pit not required	1 infiltration test and 1 test pit per 200 sf of filter area (no underdrains required**)	underdrains required
F-6 (bioretention)	1 field percolation test, test pit not required	1 infiltration test and 1 test pit per 200 sf of filter area (no underdrains required**)	underdrains required

\*feasibility test information already counts for one test location

\*\* underdrain installation still strongly suggested

**Documentation**

Infiltration testing data shall be documented, which shall also include a description of the infiltration testing method, if completed. This is to ensure that the tester understands the procedure.

**Test Pit/Boring Requirements**

- a. excavate a test pit or dig a standard soil boring to a minimum depth of 4 feet below the proposed facility bottom elevation
- b. determine depth to groundwater table (if within 4 feet of proposed bottom) upon initial digging or drilling, and again 24 hours later
- c. conduct Standard Penetration Testing (SPT) every 2' to a depth of 4 feet below the facility bottom
- d. determine USDA or Unified Soil Classification System textures at the proposed bottom and 4 feet below the bottom of the SMP
- e. determine depth to bedrock (if within 4 feet of proposed bottom)
- f. The soil description should include all soil horizons.
- g. The location of the test pit or boring shall correspond to the SMP location; test pit/soil boring stakes are to be left in the field for inspection purposes and shall be clearly labeled as such.

**Infiltration Testing Requirements**

- a. Install casing (solid 5 inch diameter, 30" length) to 24" below proposed SMP bottom (see Figure D-1).

- b. Remove any smeared soiled surfaces and provide a natural soil interface into which water may percolate. Remove all loose material from the casing. Upon the tester's discretion, a two (2) inch layer of coarse sand or fine gravel may be placed to protect the bottom from scouring and sediment. Fill casing with *clean* water to a depth of 24" and allow to pre-soak for twenty-four hours
- c. Twenty-four hours later, refill casing with another 24" of clean water and monitor water level (measured drop from the top of the casing) for 1 hour. Repeat this procedure (filling the casing each time) three additional times, for a total of four observations. Upon the tester's discretion, the final field rate may either be the average of the four observations, or the value of the last observation. The final rate shall be reported in *inches per hour*.
- d. May be done though a boring or open excavation.
- e. The location of the test shall correspond to the SMP location.
- f. Upon completion of the testing, the casings shall be immediately pulled, and the test pit shall be back-filled.

Figure D.1 Infiltration Testing Requirements

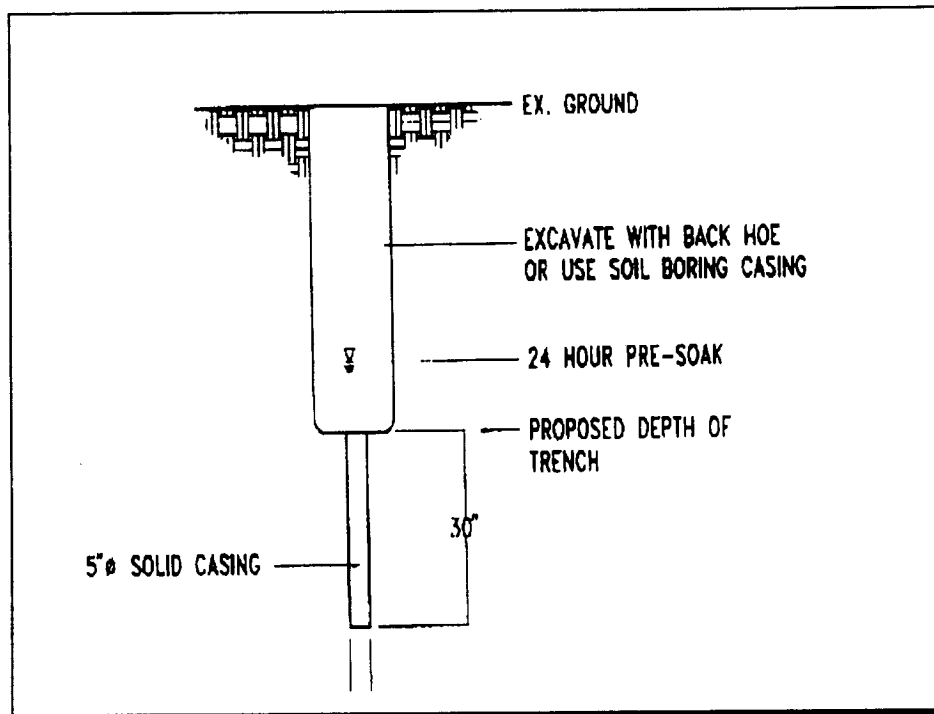

### Laboratory Testing

- a. Grain-size sieve analysis and hydrometer tests where appropriate may be used to determine USDA soils classification and textural analysis. Visual field inspection by a qualified professional may also be used, provided it is documented. *The use of lab testing to establish infiltration rates is prohibited.*



### Bioretention Testing

All areas to be used as bioretention facilities shall be back-filled with a suitable sandy loam planting media. The borrow source of this media, which may be the same or different location from the bioretention area itself, must be tested as follows:

If the borrow area is virgin, undisturbed soil, one test is required per 200 sf of borrow area; the test consists of “grab” samples at one foot depth intervals to the bottom of the borrow area. All samples at the testing location are then mixed, and the resulting sample is then lab-tested to meet the following criteria:

- a) USDA minimum textural analysis requirements: A textural analysis is required from the site stockpiled topsoil. If topsoil is imported, then a texture analysis shall be performed for each location where the top soil was excavated.

Minimum requirements:

sand	35 - 60%
silt	30 - 55%
clay	10 - 25%

- b) The soil shall be a uniform mix, free of stones, stumps, roots or other similar objects larger than two inches.
- c) Consult the bioretention construction specifications (Appendix J) for further guidance on preparing the soil for a bioretention area.

# Appendix E

New York State Stormwater Management Design Manual

R0080455

**Example Checklist for Preliminary/Concept  
Stormwater Management Plan Preparation and Review**

- Applicant information
- Name, legal address, and telephone number
- Common address and legal description of site
- Vicinity map
- Existing and proposed mapping and plans (recommended scale of 1" = 50'.) which illustrate at a minimum:
  - ▶ Existing and proposed topography (minimum of 2-foot contours recommended)
  - ▶ Perennial and intermittent streams
  - ▶ Mapping of predominant soils from USDA soil surveys
  - ▶ Boundaries of existing predominant vegetation and proposed limits of clearing
  - ▶ Location and boundaries of resource protection areas such as wetlands, lakes, ponds, and other setbacks (e.g., stream buffers, drinking water well setbacks, septic setbacks)
  - ▶ Location of existing and proposed roads, buildings, and other structures
  - ▶ Existing and proposed utilities (e.g., water, sewer, gas, electric) and easements
  - ▶ Location of existing and proposed conveyance systems such as grass channels, swales, and storm drains
  - ▶ Flow paths
  - ▶ Location of floodplain/floodway limits and relationship of site to upstream and downstream properties and drainages
  - ▶ Preliminary location and dimensions of proposed channel modifications, such as bridge or culvert crossings
  - ▶ Preliminary location, size, and limits of disturbance of proposed stormwater treatment practices
- Hydrologic and hydraulic analysis including:
  - ▶ Existing condition analysis for runoff rates, volumes, and velocities presented showing methodologies used and supporting calculations
  - ▶ Proposed condition analysis for runoff rates, volumes, and velocities showing the methodologies used and supporting calculations
  - ▶ Preliminary analysis of potential downstream impact/effects of project, where necessary
  - ▶ Preliminary selection and rationale for structural stormwater management practices
  - ▶ Preliminary sizing calculations for stormwater treatment practices including contributing drainage area, storage, and outlet configuration
- Preliminary landscaping plans for stormwater treatment practices and any site reforestation or revegetation
- Preliminary erosion and sediment control plan that at a minimum meets the requirements outlined in local Erosion and Sediment Control guidelines
- Identification of preliminary waiver requests

### **Example Checklist for Final Stormwater Management Plan Preparation and Review**

- Applicant information
  - Name, legal address, and telephone number
- Common address and legal description of site
- Signature and stamp of registered engineer/surveyor and design/owner certification
- Vicinity map
- Existing and proposed mapping and plans (recommended scale of 1" = 50' or greater detail) which illustrate at a minimum:
  - ▶ Existing and proposed topography (minimum of 2-foot contours recommended)
  - ▶ Perennial and intermittent streams
  - ▶ Mapping of predominant soils from USDA soil surveys as well as location of any site-specific borehole investigations that may have been performed.
  - ▶ Boundaries of existing predominant vegetation and proposed limits of clearing
  - ▶ Location and boundaries of resource protection areas such as wetlands, lakes, ponds, and other setbacks (e.g., stream buffers, drinking water well setbacks, septic setbacks)
  - ▶ Location of existing and proposed roads, buildings, and other structures
  - ▶ Location of existing and proposed utilities (e.g., water, sewer, gas, electric) and easements
  - ▶ Location of existing and proposed conveyance systems such as grass channels, swales, and storm drains
  - ▶ Flow paths
  - ▶ Location of floodplain/floodway limits and relationship of site to upstream and downstream properties and drainages
  - ▶ Location and dimensions of proposed channel modifications, such as bridge or culvert crossings
  - ▶ Location, size, maintenance access, and limits of disturbance of proposed structural stormwater Management practices
- Representative cross-section and profile drawings and details of structural stormwater Management practices and conveyances (i.e., storm drains, open channels, swales, etc.) which include:
  - ▶ Existing and proposed structural elevations (e.g., invert of pipes, manholes, etc.)
  - ▶ Design water surface elevations
  - ▶ Structural details of outlet structures, embankments, spillways, stilling basins, grade control structures, conveyance channels, etc.
  - ▶ Logs of borehole investigations that may have been performed along with supporting geotechnical report.

- Hydrologic and hydraulic analysis for all structural components of stormwater system (e.g., storm drains, open channels, swales, Management practices, etc.) for applicable design storms including:
  - Existing condition analysis for time of concentrations, runoff rates, volumes, velocities, and water surface elevations showing methodologies used and supporting calculations
  - ▶ Proposed condition analysis for time of concentrations, runoff rates, volumes, velocities, water surface elevations, and routing showing the methodologies used and supporting calculations
  - ▶ Final sizing calculations for structural stormwater Management practices including, contributing drainage area, storage, and outlet configuration
  - ▶ Stage-discharge or outlet rating curves and inflow and outflow hydrographs for storage facilities (e.g., stormwater ponds and wetlands)
  - ▶ Final analysis of potential downstream impact/effects of project, where necessary
  - ▶ Dam breach analysis, where necessary
- Final landscaping plans for structural stormwater Management practices and any site reforestation or revegetation
- Structural calculations, where necessary
- Applicable construction specifications
- Erosion and sediment control plan that at a minimum meets the requirements of the local Erosion and Sediment Control Guidelines
- Sequence of construction
- Maintenance plan which will include:
  - ▶ Name, address, and phone number of responsible parties for maintenance.
  - ▶ Description of annual maintenance tasks
  - ▶ Description of applicable easements
  - ▶ Description of funding source
  - ▶ Minimum vegetative cover requirements
  - ▶ Access and safety issues
  - ▶ Testing and disposal of sediments that will likely be necessary
- Evidence of acquisition of all applicable local and non-local permits
- Evidence of acquisition of all necessary legal agreements (e.g., easements, covenants, land trusts)
- Waiver requests
- Review agency should have inspector's checklist identifying potential features to be inspected on site visits

# Appendix F

New York State Stormwater Management Design Manual

R0080459

**Appendix F: Construction Inspection Checklists**

**Stormwater/Wetland Pond Construction Inspection Checklist**

Project:

Location:

Site Status:

Date:

Time:

Inspector:

CONSTRUCTION SEQUENCE	SATISFACTORY/ UNSATISFACTORY	COMMENTS
<b>Pre-Construction/Materials and Equipment</b>		
Pre-construction meeting		
Pipe and appurtenances on-site prior to construction and dimensions checked		
1. Material (including protective coating, if specified)		
2. Diameter		
3. Dimensions of metal riser or pre-cast concrete outlet structure		
4. Required dimensions between water control structures (orifices, weirs, etc.) are in accordance with approved plans		
5. Barrel stub for prefabricated pipe structures at proper angle for design barrel slope		
6. Number and dimensions of prefabricated anti-seep collars		
7. Watertight connectors and gaskets		
8. Outlet drain valve		
Project benchmark near pond site		
Equipment for temporary de-watering		

CONSTRUCTION SEQUENCE	SATISFACTORY/ UNSATISFACTORY	COMMENTS
<b>2. Subgrade Preparation</b>		
Area beneath embankment stripped of all vegetation, topsoil, and organic matter		
<b>3. Pipe Spillway Installation</b>		
Method of installation detailed on plans		
<b>A. Bed preparation</b>		
Installation trench excavated with specified side slopes		
Stable, uniform, dry subgrade of relatively impervious material (If subgrade is wet, contractor shall have defined steps before proceeding with installation)		
Invert at proper elevation and grade		
<b>B. Pipe placement</b>		
Metal / plastic pipe		
1. Watertight connectors and gaskets properly installed		
2. Anti-seep collars properly spaced and having watertight connections to pipe		
3. Backfill placed and tamped by hand under "haunches" of pipe		
4. Remaining backfill placed in max. 8 inch lifts using small power tamping equipment until 2 feet cover over pipe is reached		



CONSTRUCTION SEQUENCE	SATISFACTORY/ UNSATISFACTORY	COMMENTS
<b>3. Pipe Spillway Installation</b>		
Concrete pipe		
1. Pipe set on blocks or concrete slab for pouring of low cradle		
2. Pipe installed with rubber gasket joints with no spalling in gasket interface area		
3. Excavation for lower half of anti-seep collar(s) with reinforcing steel set		
4. Entire area where anti-seep collar(s) will come in contact with pipe coated with mastic or other approved waterproof sealant		
5. Low cradle and bottom half of anti-seep collar installed as monolithic pour and of an approved mix		
6. Upper half of anti-seep collar(s) formed with reinforcing steel set		
7. Concrete for collar of an approved mix and vibrated into place (protected from freezing while curing, if necessary)		
8. Forms stripped and collar inspected for honeycomb prior to backfilling. Parge if necessary.		
<b>C. Backfilling</b>		
Fill placed in maximum 8 inch lifts		
Backfill taken minimum 2 feet above top of anti-seep collar elevation before traversing with heavy equipment		

CONSTRUCTION SEQUENCE	SATISFACTORY/ UNSATISFACTORY	COMMENTS
<b>4. Riser / Outlet Structure Installation</b>		
Riser located within embankment		
A. Metal riser		
Riser base excavated or formed on stable subgrade to design dimensions		
Set on blocks to design elevations and plumbed		
Reinforcing bars placed at right angles and projecting into sides of riser		
Concrete poured so as to fill inside of riser to invert of barrel		
B. Pre-cast concrete structure		
Dry and stable subgrade		
Riser base set to design elevation		
If more than one section, no spalling in gasket interface area; gasket or approved caulking material placed securely		
Watertight and structurally sound collar or gasket joint where structure connects to pipe spillway		
C. Poured concrete structure		
Footing excavated or formed on stable subgrade, to design dimensions with reinforcing steel set		
Structure formed to design dimensions, with reinforcing steel set as per plan		
Concrete of an approved mix and vibrated into place (protected from freezing while curing, if necessary)		
Forms stripped & inspected for "honeycomb" prior to backfilling; parge if necessary		

CONSTRUCTION SEQUENCE	SATISFACTORY/ UNSATISFACTORY	COMMENTS
<b>5. Embankment Construction</b>		
Fill material		
Compaction		
Embankment		
1. Fill placed in specified lifts and compacted with appropriate equipment		
2. Constructed to design cross-section, side slopes and top width		
3. Constructed to design elevation plus allowance for settlement		
<b>6. Impounded Area Construction</b>		
Excavated / graded to design contours and side slopes		
Inlet pipes have adequate outfall protection		
Forebay(s)		
Pond benches		
<b>7. Earth Emergency Spillway Construction</b>		
Spillway located in cut or structurally stabilized with riprap, gabions, concrete, etc.		
Excavated to proper cross-section, side slopes and bottom width		
Entrance channel, crest, and exit channel constructed to design grades and elevations		

CONSTRUCTION SEQUENCE	SATISFACTORY / UNSATISFACTORY	COMMENTS
<b>8. Outlet Protection</b>		
A. End section		
Securely in place and properly backfilled		
B. Endwall		
Footing excavated or formed on stable subgrade, to design dimensions and reinforcing steel set, if specified		
Endwall formed to design dimensions with reinforcing steel set as per plan		
Concrete of an approved mix and vibrated into place (protected from freezing, if necessary)		
Forms stripped and structure inspected for "honeycomb" prior to backfilling; parge if necessary		
C. Riprap apron / channel		
Apron / channel excavated to design cross-section with proper transition to existing ground		
Filter fabric in place		
Stone sized as per plan and uniformly place at the thickness specified		
<b>9. Vegetative Stabilization</b>		
Approved seed mixture or sod		
Proper surface preparation and required soil amendments		
Excelsior mat or other stabilization, as per plan		

CONSTRUCTION SEQUENCE	SATISFACTORY/ UNSATISFACTORY	COMMENTS
<b>10. Miscellaneous</b>		
Drain for ponds having a permanent pool		
Trash rack / anti-vortex device secured to outlet structure		
Trash protection for low flow pipes, orifices, etc.		
Fencing (when required)		
Access road		
Set aside for clean-out maintenance		
<b>11. Stormwater Wetlands</b>		
Adequate water balance		
Variety of depth zones present		
Approved pondscaping plan in place Reinforcement budget for additional plantings		
Plants and materials ordered 6 months prior to construction		
Construction planned to allow for adequate planting and establishment of plant community (April-June planting window)		
Wetland buffer area preserved to maximum extent possible		

**Comments:**

---



---



---



---



---



---



---



---



---



---

**Actions to be Taken:**

---

---

---

---

---

---

---

---

---

---

## Infiltration Trench Construction Inspection Checklist

Project:  
 Location:  
 Site Status:

Date:

Time:

Inspector:

CONSTRUCTION SEQUENCE	SATISFACTORY/ UNSATISFACTORY	COMMENTS
<b>1. Pre-Construction</b>		
Pre-construction meeting		
Runoff diverted		
Soil permeability tested		
Groundwater / bedrock sufficient at depth		
<b>2. Excavation</b>		
Size and location		
Side slopes stable		
Excavation does not compact subsoils		
<b>3. Filter Fabric Placement</b>		
Fabric specifications		
Placed on bottom, sides, and top		







## Infiltration Basin Construction Inspection Checklist

Project:  
 Location:  
 Site Status:

Date:

Time:

Inspector:

CONSTRUCTION SEQUENCE	SATISFACTORY/ UNSATISFACTORY	COMMENTS
<b>1. Pre-Construction</b>		
Runoff diverted		
Soil permeability tested		
Groundwater / bedrock depth		
<b>2. Excavation</b>		
Size and location		
Side slopes stable		
Excavation does not compact subsoils		
<b>3. Embankment</b>		
Barrel		
Anti-seep collar or Filter diaphragm		
Fill material		



## Sand/Organic Filter System Construction Inspection Checklist

Project:  
 Location:  
 Site Status:

Date:

Time:

Inspector:

CONSTRUCTION SEQUENCE	SATISFACTORY / UNSATISFACTORY	COMMENTS
<b>1. Pre-construction</b>		
Pre-construction meeting		
Runoff diverted		
Facility area cleared		
Facility location staked out		
<b>2. Excavation</b>		
Size and location		
Side slopes stable		
Foundation cleared of debris		
If designed as exfilter, excavation does not compact subsoils		
Foundation area compacted		
<b>3. Structural Components</b>		
Dimensions and materials		
Forms adequately sized		
Concrete meets standards		
Prefabricated joints sealed		
Underdrains (size, materials)		

CONSTRUCTION SEQUENCE	SATISFACTORY / UNSATISFACTORY	COMMENTS
<b>4. Completed Facility Components</b>		
24 hour water filled test		
Contributing area stabilized		
Filter material per specification		
Underdrains installed to grade		
Flow diversion structure properly installed		
Pretreatment devices properly installed		
Level overflow weirs, multiple orifices, distribution slots		
<b>5. Final Inspection</b>		
Dimensions		
Surface completely level		
Structural components		
Proper outlet		
Ensure that site is properly stabilized before flow is directed to the structure.		



## Bioretention Construction Inspection Checklist

Project:  
 Location:  
 Site Status:

Date:

Time:

Inspector:

CONSTRUCTION SEQUENCE	SATISFACTORY/ UNSATISFACTORY	COMMENTS
<b>1. Pre-Construction</b>		
Pre-construction meeting		
Runoff diverted		
Facility area cleared		
If designed as exfilter, soil testing for permeability		
Facility location staked out		
<b>2. Excavation</b>		
Size and location		
Lateral slopes completely level		
If designed as exfilter, ensure that excavation does not compact susoils.		
Longitudinal slopes within design range		

CONSTRUCTION SEQUENCE	SATISFACTORY / UNSATISFACTORY	COMMENTS
<b>3. Structural Components</b>		
Stone diaphragm installed correctly		
Outlets installed correctly		
Underdrain		
Pretreatment devices installed		
Soil bed composition and texture		
<b>4. Vegetation</b>		
Complies with planting specs		
Topsoil adequate in composition and placement		
Adequate erosion control measures in place		
<b>5. Final Inspection</b>		
Dimensions		
Proper stone diaphragm		
Proper outlet		
Soil/ filter bed permeability testing		
Effective stand of vegetation and stabilization		
Construction generated sediments removed		
Contributing watershed stabilized before flow is diverted to the practice		





## Open Channel System Construction Inspection Checklist

Project:  
 Location:  
 Site Status:

Date:

Time:

Inspector:

CONSTRUCTION SEQUENCE	SATISFACTORY / UNSATISFACTORY	COMMENTS
<b>1. Pre-Construction</b>		
Pre-construction meeting		
Runoff diverted		
Facility location staked out		
<b>2. Excavation</b>		
Size and location		
Side slope stable		
Soil permeability		
Groundwater / bedrock		
Lateral slopes completely level		
Longitudinal slopes within design range		
Excavation does not compact subsoils		
<b>3. Check dams</b>		
Dimensions		
Spacing		
Materials		

CONSTRUCTION SEQUENCE	SATISFACTORY / UNSATISFACTORY	COMMENTS
<b>4. Structural Components</b>		
Underdrain installed correctly		
Inflow installed correctly		
Pretreatment devices installed		
<b>5. Vegetation</b>		
Complies with planting specifications		
Topsoil adequate in composition and placement		
Adequate erosion control measures in place		
<b>6. Final inspection</b>		
Dimensions		
Check dams		
Proper outlet		
Effective stand of vegetation and stabilization		
Contributing watershed stabilized before flow is routed to the facility		

**Comments:**

---



---



---



---



---



---



---



---



---



---



---



---



---



---



---



---



---



---



---



---



---



---



# Appendix G

New York State Stormwater Management Design Manual

R0080482

**Appendix G: Maintenance Inspection Checklists**

**Stormwater Pond/Wetland Operation, Maintenance and Management Inspection Checklist**

Project \_\_\_\_\_

Location: \_\_\_\_\_

Site Status: \_\_\_\_\_

Date: \_\_\_\_\_

Time: \_\_\_\_\_

Inspector: \_\_\_\_\_

Maintenance Item	Satisfactory/ Unsatisfactory	Comments
<b>1. Embankment and emergency spillway (Annual, After Major Storms)</b>		
1. Vegetation and ground cover adequate		
2. Embankment erosion		
3. Animal burrows		
4. Unauthorized planting		
5. Cracking, bulging, or sliding of dam		
a. Upstream face		
b. Downstream face		
c. At or beyond toe		
downstream		
upstream		
d. Emergency spillway		
6. Pond, toe & chimney drains clear and functioning		
7. Seeps/leaks on downstream face		
8. Slope protection or riprap failure		
9. Vertical/horizontal alignment of top of dam "As-Built"		

Maintenance Item	Satisfactory/ Unsatisfactory	Comments
10. Emergency spillway clear of obstructions and debris		
11. Other (specify)		
<b>2. Riser and principal spillway (Annual)</b>		
Type: Reinforced concrete _____ Corrugated pipe _____ Masonry _____		
1. Low flow orifice obstructed		
2. Low flow trash rack. a. Debris removal necessary		
b. Corrosion control		
3. Weir trash rack maintenance a. Debris removal necessary		
b. corrosion control		
4. Excessive sediment accumulation insider riser		
5. Concrete/masonry condition riser and barrels a. cracks or displacement		
b. Minor spalling (<1" )		
c. Major spalling (rebars exposed)		
d. Joint failures		
e. Water tightness		
6. Metal pipe condition		
7. Control valve a. Operational/exercised		
b. Chained and locked		
8. Pond drain valve a. Operational/exercised		
b. Chained and locked		
9. Outfall channels functioning		
10. Other (specify)		

Maintenance Item	Satisfactory/ Unsatisfactory	Comments
<b>3. Permanent Pool (Wet Ponds) (monthly)</b>		
1. Undesirable vegetative growth		
2. Floating or floatable debris removal required		
3. Visible pollution		
4. Shoreline problem		
5. Other (specify)		
<b>4. Sediment Forebays</b>		
1. Sedimentation noted		
2. Sediment cleanout when depth < 50% design depth		
<b>5. Dry Pond Areas</b>		
1. Vegetation adequate		
2. Undesirable vegetative growth		
3. Undesirable woody vegetation		
4. Low flow channels clear of obstructions		
5. Standing water or wet spots		
6. Sediment and / or trash accumulation		
7. Other (specify)		
<b>6. Condition of Outfalls (Annual , After Major Storms)</b>		
1. Riprap failures		
2. Slope erosion		
3. Storm drain pipes		
4. Endwalls / Headwalls		
5. Other (specify)		
<b>7. Other ( Monthly)</b>		
1. Encroachment on pond, wetland or easement area		



Maintenance Item	Satisfactory/ Unsatisfactory	Comments
2. Complaints from residents		
3. Aesthetics		
a. Grass growing required		
b. Graffiti removal needed		
c. Other (specify)		
4. Conditions of maintenance access routes.		
5. Signs of hydrocarbon build-up		
6. Any public hazards (specify)		
<b>8. Wetland Vegetation (Annual)</b>		
1. Vegetation healthy and growing Wetland maintaining 50% surface area coverage of wetland plants after the second growing season. (If unsatisfactory, reinforcement plantings needed)		
2. Dominant wetland plants: Survival of desired wetland plant species Distribution according to landscaping plan?		
3. Evidence of invasive species		
4. Maintenance of adequate water depths for desired wetland plant species		
5. Harvesting of emergent plantings needed		
6. Have sediment accumulations reduced pool volume significantly or are plants "choked" with sediment		
7. Eutrophication level of the wetland.		
8. Other (specify)		

**Comments:**

---



---



---



---



---

**Actions to be Taken:**

---

---

---

---

### Infiltration Trench Operation, Maintenance, and Management Inspection Checklist

Project:  
 Location:  
 Site Status:

Date:

Time:

Inspector:

MAINTENANCE ITEM	SATISFACTORY / UNSATISFACTORY	COMMENTS
<b>1. Debris Cleanout (Monthly)</b>		
Trench surface clear of debris		
Inflow pipes clear of debris		
Overflow spillway clear of debris		
Inlet area clear of debris		
<b>2. Sediment Traps or Forebays (Annual)</b>		
Obviously trapping sediment		
Greater than 50% of storage volume remaining		
<b>3. Dewatering (Monthly)</b>		
Trench dewaterers between storms		
<b>4. Sediment Cleanout of Trench (Annual)</b>		
No evidence of sedimentation in trench		
Sediment accumulation doesn't yet require cleanout		
<b>5. Inlets (Annual)</b>		

MAINTENANCE ITEM	SATISFACTORY / UNSATISFACTORY	COMMENTS
Good condition		
No evidence of erosion		
<b>6. Outlet/Overflow Spillway (Annual)</b>		
Good condition, no need for repair		
No evidence of erosion		
<b>7. Aggregate Repairs (Annual)</b>		
Surface of aggregate clean		
Top layer of stone does not need replacement		
Trench does not need rehabilitation		

**Comments:**

---



---



---



---



---



---



---

**Actions to be Taken:**

---



---



---



---



---



---



---

### Sand/Organic Filter Operation, Maintenance and Management Inspection Checklist

Project:  
Location:  
Site Status:

Date:

Time:

Inspector:

MAINTENANCE ITEM	SATISFACTORY / UNSATISFACTORY	COMMENTS
<b>1. Debris Cleanout (Monthly)</b>		
Contributing areas clean of debris		
Filtration facility clean of debris		
Inlet and outlets clear of debris		
<b>2. Oil and Grease (Monthly)</b>		
No evidence of filter surface clogging		
Activities in drainage area minimize oil and grease entry		
<b>3. Vegetation (Monthly)</b>		
Contributing drainage area stabilized		
No evidence of erosion		
Area mowed and clipping removed		
<b>4. Water Retention Where Required (Monthly)</b>		
Water holding chambers at normal pool		
No evidence of leakage		
<b>5. Sediment Deposition (Annual)</b>		

MAINTENANCE ITEM	SATISFACTORY / UNSATISFACTORY	COMMENTS
Filter chamber free of sediments		
Sedimentation chamber not more than half full of sediments		
<b>6. Structural Components (Annual)</b>		
No evidence of structural deterioration		
Any grates are in good condition		
No evidence of spalling or cracking of structural parts		
<b>7. Outlet/Overflow Spillway (Annual)</b>		
Good condition, no need for repairs		
No evidence of erosion (if draining into a natural channel)		
<b>8. Overall Function of Facility (Annual)</b>		
Evidence of flow bypassing facility		
No noticeable odors outside of facility		

**Comments:**

---

---

---

---

---

---

---

---

---

---

**Actions to be Taken:**

---

---

---

---

---

---

---

---

---

---

### Bioretention Operation, Maintenance and Management Inspection Checklist

Project:  
 Location:  
 Site Status:

Date:

Time:

Inspector:

MAINTENANCE ITEM	SATISFACTORY / UNSATISFACTORY	COMMENTS
<b>1. Debris Cleanout (Monthly)</b>		
Bioretention and contributing areas clean of debris		
No dumping of yard wastes into practice		
Litter (branches, etc.) have been removed		
<b>2. Vegetation (Monthly)</b>		
Plant height not less than design water depth		
Fertilized per specifications		
Plant composition according to approved plans		
No placement of inappropriate plants		
Grass height not greater than 6 inches		
No evidence of erosion		
<b>3. Check Dams/Energy Dissipaters/Sumps (Annual, After Major Storms)</b>		
No evidence of sediment buildup		

MAINTENANCE ITEM	SATISFACTORY / UNSATISFACTORY	COMMENTS
Sumps should not be more than 50% full of sediment		
No evidence of erosion at downstream toe of drop structure		
<b>4. Dewatering (Monthly)</b>		
Dewaters between storms		
No evidence of standing water		
<b>5. Sediment Deposition (Annual)</b>		
Swale clean of sediments		
Sediments should not be > 20% of swale design depth		
<b>6. Outlet/Overflow Spillway (Annual, After Major Storms)</b>		
Good condition, no need for repair		
No evidence of erosion		
No evidence of any blockages		
<b>7. Integrity of Filter Bed (Annual)</b>		
Filter bed has not been blocked or filled inappropriately		



**Comments:**

---

---

---

---

---

---

---

---

**Actions to be Taken:**

---

---

---

---

---

---

---

---

### Open Channel Operation, Maintenance, and Management Inspection Checklist

Project:  
 Location:  
 Site Status:

Date:

Time:

Inspector:

MAINTENANCE ITEM	SATISFACTORY/ UNSATISFACTORY	COMMENTS
<b>1. Debris Cleanout (Monthly)</b>		
Contributing areas clean of debris		
<b>2. Check Dams or Energy Dissipators (Annual, After Major Storms)</b>		
No evidence of flow going around structures		
No evidence of erosion at downstream toe		
Soil permeability		
Groundwater / bedrock		
<b>3. Vegetation (Monthly)</b>		
Mowing done when needed		
Minimum mowing depth not exceeded		
No evidence of erosion		
Fertilized per specification		
<b>4. Dewatering (Monthly)</b>		
Dewaters between storms		

MAINTENANCE ITEM	SATISFACTORY/ UNSATISFACTORY	COMMENTS
<b>5. Sediment deposition (Annual)</b>		
Clean of sediment		
<b>6. Outlet/Overflow Spillway (Annual)</b>		
Good condition, no need for repairs		
No evidence of erosion		

**Comments:**

---

---

---

---

---

---

---

---

---

---

**Actions to be Taken:**

---

---

---

---

---

---

---

---

---

---

# Appendix H

## Appendix H: Landscaping Guidance/Plant Lists

### H.1 Ponds and Wetlands

For areas that are to be planted within a stormwater pond, it is necessary to determine what type of hydrologic zones will be created within the pond. The following six zones describe the different conditions encountered in stormwater management facilities. Every facility does not necessarily reflect all of these zones. The hydrologic zones designate the degree of tolerance the plant exhibits to differing degrees of inundation by water.

Table H.5 at the end of this appendix designates appropriate zones for each plant. There may be other zones listed outside of these brackets. The plant materials may occur within these zones, but are not typically found in them. Plants suited for specific hydrologic conditions may perish when those conditions change, exposing the soil, and therefore, increasing the chance for erosion.

Each zone has its own set of plant selection criteria based on the hydrology of the zone, the stormwater functions required of the plant and the desired landscape effect. The hydrologic zones are as follows:

<b><u>Zone #</u></b>	<b><u>Zone Description</u></b>	<b><u>Hydrologic Conditions</u></b>
Zone 1	Deep Water Pool	1-6 feet deep Permanent Pool
Zone 2	Shallow Water Bench	6 inches to 1 foot deep
Zone 3	Shoreline Fringe	Regularly inundated
Zone 4	Riparian Fringe	Periodically inundated
Zone 5	Floodplain Terrace	Infrequently inundated
Zone 6	Upland Slopes	Seldom or never inundated

#### **Zone 1: Deep Water Area (1- 6 Feet)**

Ponds and wetlands both have deep pool areas that comprise Zone 1. These pools range from one to six feet in depth, and are best colonized by submergent plants, if at all.

This pondscaping zone has not been routinely planted for several reasons. First, the availability of plant materials that can survive and grow in this zone is limited, and it is also feared that plants could clog the stormwater facility outlet structure. In many cases, these plants will gradually become established through natural recolonization (e.g., transport of plant fragments from other ponds via the feet and legs of waterfowl). If submerged plant material becomes more commercially available and clogging concerns are addressed, this area can be planted. The function of the planting is to reduce resedimentation and improve oxidation while creating a greater aquatic habitat.

- ▶ Plant material must be able to withstand constant inundation of water of one foot or greater in depth.
- ▶ Plants may be submerged partially or entirely.
- ▶ Plants should be able to enhance pollutant uptake.
- ▶ Plants may provide food and cover for waterfowl, desirable insects, and other aquatic life.

### **Zone 2: Shallow Water Bench (*Normal Pool To 1 Foot*)**

Zone 2 includes all areas that are inundated below the normal pool to a depth of one foot, and is the primary area where emergent plants will grow in a stormwater wetlands. Zone 2 also coincides with the aquatic bench found in stormwater ponds. This zone offers ideal conditions for the growth of many emergent wetland species. These areas may be located at the edge of the pond or on low mounds of earth located below the surface of the water within the pond. When planted, Zone 2 can be an important habitat for many aquatic and nonaquatic animals, creating a diverse food chain. This food chain includes predators, allowing a natural regulation of mosquito populations, thereby reducing the need for insecticidal applications.

- ▶ Plant material must be able to withstand constant inundation of water to depths between six inches and one foot deep.
- ▶ Plants will be partially submerged.
- ▶ Plants should be able to enhance pollutant uptake.
- ▶ Plants may provide food and cover for waterfowl, desirable insects and other aquatic life.

Plants will stabilize the bottom of the pond, as well as the edge of the pond, absorbing wave impacts and reducing erosion, when water level fluctuates. Plant also slow water velocities and increase sediment deposition rates. Plants can reduce resuspension of sediments caused by the wind. Plants can also soften the engineered contours of the pond, and can conceal drawdowns during dry weather.

### **Zone 3: Shoreline Fringe (*Regularly Inundated*)**

Zone 3 encompasses the shoreline of a pond or wetland, and extends vertically about one foot in elevation from the normal pool. This zone includes the safety bench of a pond, and may also be periodically inundated if storm events are subject to extended detention. This zone occurs in a wet pond or shallow marsh and can be the most difficult to establish since plants must be able to withstand inundation of water during storms, when wind might blow water into the area, or the occasional drought during the summer. In order to stabilize the soil in this zone, Zone 3 must have a vigorous cover.

- ▶ Plants should stabilize the shoreline to minimize erosion caused by wave and wind action or water fluctuation.
- ▶ Plant material must be able to withstand occasional inundation of water. Plants will be partially submerged at this time.
- ▶ Plant material should, whenever possible, shade the shoreline, especially the southern exposure. This will help to reduce the water temperature.

- ▶ Plants should be able to enhance pollutant uptake.
- ▶ Plants may provide food and cover for waterfowl, songbirds, and wildlife. Plants could also be selected and located to control overpopulation of waterfowl.
- ▶ Plants should be located to reduce human access, where there are potential hazards, but should not block the maintenance access.
- ▶ Plants should have very low maintenance requirements, since they may be difficult or impossible to reach.
- ▶ Plants should be resistant to disease and other problems which require chemical applications (since chemical application is not advised in stormwater ponds).

#### **Zone 4: Riparian Fringe (*Periodically Inundated*)**

Zone 4 extends from one to four feet in elevation above the normal pool. Plants in this zone are subject to periodic inundation after storms, and may experience saturated or partly saturated soil conditions. Nearly all of the temporary ED area is included within this zone.

- ▶ Plants must be able to withstand periodic inundation of water after storms, as well as occasional drought during the warm summer months.
- ▶ Plants should stabilize the ground from erosion caused by run-off.
- ▶ Plants should shade the low flow channel to reduce the pool warming whenever possible.
- ▶ Plants should be able to enhance pollutant uptake.
- ▶ Plant material should have very low maintenance, since they may be difficult or impossible to access.
- ▶ Plants may provide food and cover for waterfowl, songbirds and wildlife. Plants may also be selected and located to control overpopulation of waterfowl.
- ▶ Plants should be located to reduce pedestrian access to the deeper pools.

#### **Zone 5: Floodplain Terrace (*Infrequently Inundated*)**

Zone 5 is periodically inundated by flood waters that quickly recedes in a day or less. Operationally, Zone 5 extends from the maximum two year or C<sub>pv</sub> water surface elevation up to the 10 or 100 year maximum water surface elevation. Key landscaping objectives for Zone 5 are to stabilize the steep slopes characteristic of this zone, and establish a low maintenance, natural vegetation.

- ▶ Plant material should be able to withstand occasional but brief inundation during storms, although typical moisture conditions may be moist, slightly wet, or even swing entirely to drought conditions during the dry weather periods.
- ▶ Plants should stabilize the basin slopes from erosion.
- ▶ Ground cover should be very low maintenance, since they may be difficult to access on steep slopes or if frequency of mowing is limited. A dense tree cover may help reduce maintenance and discourage resident geese.
- ▶ Plants may provide food and cover for waterfowl, songbirds, and wildlife.

- ▶ Placement of plant material in Zone 5 is often critical, as it often creates a visual focal point and provides structure and shade for a greater variety of plants.

### **Zone 6: Upland Slopes (*Seldom or Never Inundated*)**

The last zone extends above the maximum 100 year water surface elevation, and often includes the outer buffer of a pond or wetland. Unlike other zones, this upland area may have sidewalks, bike paths, retaining walls, and maintenance access roads. Care should be taken to locate plants so they will not overgrow these routes or create hiding places that might make the area unsafe.

- ▶ Plant material is capable of surviving the particular conditions of the site. Thus, it is not necessary to select plant material that will tolerate any inundation. Rather, plant selections should be made based on soil condition, light, and function within the landscape.
- ▶ Ground covers should emphasize infrequent mowing to reduce the cost of maintaining this landscape.
- ▶ Placement of plants in Zone 6 is important since they are often used to create a visual focal point, frame a desirable view, screen undesirable views, serve as a buffer, or provide shade to allow a greater variety of plant materials. Particular attention should be paid to seasonal color and texture of these plantings.



## II.2 Bioretention

### *Planting Soil Bed Characteristics*

The characteristics of the soil for the bioretention facility are perhaps as important as the facility location, size, and treatment volume. The soil must be permeable enough to allow runoff to filter through the media, while having characteristics suitable to promote and sustain a robust vegetative cover crop. In addition, much of the nutrient pollutant uptake (nitrogen and phosphorus) is accomplished through adsorption and microbial activity within the soil profile. Therefore, the soils must balance soil chemistry and physical properties to support biotic communities above and below ground.

The planting soil should be a sandy loam, loamy sand, loam (USDA), or a loam/sand mix (should contain a minimum 35 to 60% sand, by volume). The clay content for these soils should be less than 25% by volume. Soils should fall within the SM, or ML classifications of the Unified Soil Classification System (USCS). A permeability of at least 1.0 feet per day (0.5"/hr) is required (a conservative value of 0.5 feet per day is used for design). The soil should be free of stones, stumps, roots, or other woody material over 1" in diameter. Brush or seeds from noxious weeds. Placement of the planting soil should be in lifts of 12 to 18", loosely compacted (tamped lightly with a dozer or backhoe bucket). The specific characteristics are presented in Table H.2.

**Table H.2** Planting Soil Characteristics

Parameter	Value
PH range	5.2 to 7.00
Organic matter	1.5 to 4.0%
Magnesium	35 lbs. per acre, minimum
Phosphorus (P <sub>2</sub> O <sub>5</sub> )	75 lbs. per acre, minimum
Potassium (K <sub>2</sub> O)	85 lbs. per acre, minimum
Soluble salts	≤ 500 ppm
Clay	10 to 25%
Silt	30 to 55%
Sand	35 to 60%

### *Mulch Layer*

The mulch layer plays an important role in the performance of the bioretention system. The mulch layer helps maintain soil moisture and avoid surface sealing which reduces permeability. Mulch helps prevent erosion, and provides a micro-environment suitable for soil biota at the mulch/soil interface. It also serves as a pretreatment layer, trapping the finer sediments which remain suspended after the primary pretreatment.

The mulch layer should be standard landscape style, single or double, shredded hardwood mulch or chips. The mulch layer should be well aged (stockpiled or stored for at least 12 months), uniform in color, and free of other materials, such as weed seeds, soil, roots, etc. The mulch should be applied to a maximum depth of three inches. Grass clippings should not be used as a mulch material.

### *Planting Plan Guidance*

Plant material selection should be based on the goal of simulating a terrestrial forested community of native species. Bioretention simulates an ecosystem consisting of an upland-oriented community dominated by trees, but having a distinct community, or sub-canopy, of understory trees, shrubs and herbaceous materials. The intent is to establish a diverse, dense plant cover to treat stormwater runoff and withstand urban stresses from insect and disease infestations, drought, temperature, wind, and exposure.

The proper selection and installation of plant materials is key to a successful system. There are essentially three zones within a bioretention facility (Figure H.1). The lowest elevation supports plant species adapted to standing and fluctuating water levels. The middle elevation supports a slightly drier group of plants, but still tolerates fluctuating water levels. The outer edge is the highest elevation and generally supports plants adapted to dryer conditions. When using Table A.5 to identify species, use the following guideline:

Lowest Zone: Zones 2-3

Middle Zone: Zones 3-4

Outer Zone: Zones 5-6

The layout of plant material should be flexible, but should follow the general principals described in Table H.3. The objective is to have a system which resembles a random and natural plant layout, while maintaining optimal conditions for plant establishment and growth.

Figure H.1 Planting Zones for Bioretention Facilities

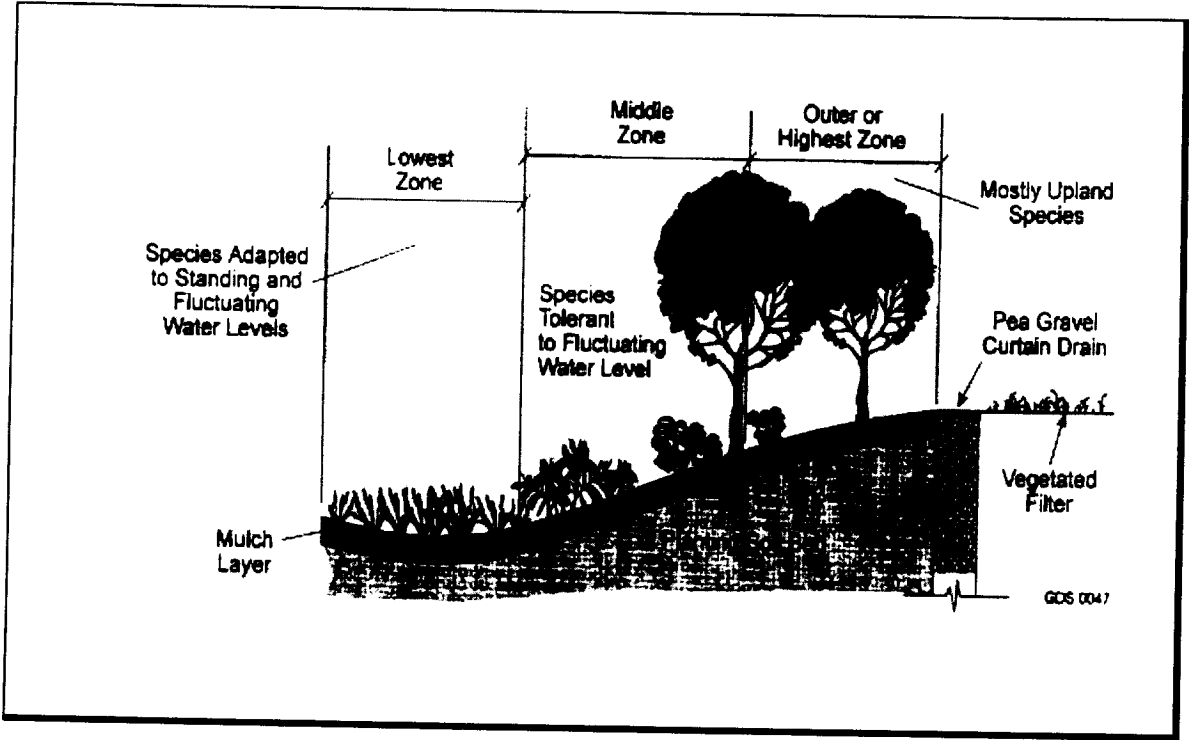

<b>Table H.3 Planting Plan Design Considerations</b>
Native plant species should be specified over exotic or foreign species.
Appropriate vegetation should be selected based on the zone of hydric tolerance (see Figure H.1).
Species layout should generally be random and natural.
A canopy should be established with an understory of shrubs and herbaceous materials.
Woody vegetation should not be specified in the vicinity of inflow locations.
Trees should be planted primarily along the perimeter of the bioretention area.
Urban stressors (e.g., wind, sun, exposure, insect and disease infestation, drought) should be considered when laying out the planting plan.
Noxious weeds should not be specified.
Aesthetics and visual characteristics should be a prime consideration.
Traffic and safety issues must be considered.
Existing and proposed utilities must be identified and considered.

*Plant Material Guidance*

Plant materials should conform to the American Standard Nursery Stock, published by the American Association of Nurserymen, and should be selected from certified, reputable nurseries. Planting specifications should be prepared by the designer and should include a sequence of construction, a description of the contractor's responsibilities, a planting schedule and installation specifications, initial maintenance, and a warranty period and expectations of plant survival. Table H.4 presents some typical issues for planting specifications.

<b>Table H.4 Planting Specification Issues for Bioretention Areas</b>	
<b>Specification Element</b>	<b>Elements</b>
<b>Sequence of Construction</b>	Describe site preparation activities, soil amendments, etc.; address erosion and sediment control procedures; specify step-by-step procedure for plant installation through site clean-up.
<b>Contractor's Responsibilities</b>	Specify the contractor's responsibilities, such as watering, care of plant material during transport, timeliness of installation, repairs due to vandalism, etc.
<b>Planting Schedule and Specifications</b>	Specify the materials to be installed, the type of materials (e.g., B&B, bare root, containerized); time of year of installations, sequence of installation of types of plants; fertilization, stabilization seeding, if required; watering and general care.
<b>Maintenance</b>	Specify inspection periods; mulching frequency (annual mulching is most common); removal and replacement of dead and diseased vegetation; treatment of diseased trees; watering schedule after initial installation (once per day for 14 days is common); repair and replacement of staking and wires.
<b>Warranty</b>	Specify the warranty period, the required survival rate, and expected condition of plant species at the end of the warranty period.

Table H.5 Native Plant Guide for Stormwater Management Areas (NY)						
Plant Name	Zone	Form	Available	Inundation Tolerance	Wildlife Value	Notes
<b>Trees and Shrubs</b>						
American Elm <i>(Ulmus americana)</i>	4,5,6	Dec. Tree	yes	Irregular-seasonal saturation	High. Food (seeds, browsing), cover, nesting for birds & mammals	Susceptible to disease (short-lived). Sun to full shade, tolerates drought and wind/ice damage.
Arrowwood Viburnum <i>(Viburnum dentatum)</i>	3,4	Dec. Shrub	yes	yes	High. Songbirds and mammals	Grows best in sun to partial shade
Bald Cypress <i>(Taxodium distichum)</i>	3,4	Dec. Tree	yes	yes	Little food value, but good perching site for waterfowl	Forested Coastal Plain. North of normal range. Tolerates drought.
Bayberry <i>(Myrica pensylvanica)</i>	4,5,6	Dec. Shrub	yes	yes	High. Nesting, food, cover. Berries last into winter	Coastal Plain only. Roots fix N <sub>2</sub> . Tolerates slightly acidic soils.
Black Ash <i>(Fraxinus nigra)</i>	3,4,5	Dec. Tree	yes	Irregular-seasonal saturation	High. Food (seeds, sap), cover, nesting for birds & mammals. Fruit persists in winter	Rapid growth. Requires full sun. Susceptible to wind/ice damage & disease. Tolerates drought and infrequent flooding by salt water.
Black Cherry <i>(Prunus serotina)</i>	5,6	Dec. Tree	yes	no	High. Food	Moist soils or wet bottomland areas
Blackgum or Sourgum <i>(Nyssa sylvatica)</i>	4,5,6	Dec. Tree	yes	yes	High. Songbirds, egrets, herons, raccoons, owls	Can be difficult to transplant. Prefers sun to partial shade
Black Willow <i>(Salix nigra)</i>	3,4,5	Dec. Tree	yes	yes	High. Browsing and cavity nesters.	Rapid growth, stabilizes streambanks. Full sun
Buttonbush <i>(Cephalanthus occidentalis)</i>	2,3,4,5	Dec. Shrub	yes	yes	High. Ducks and shorebirds. Seeds, nectar and nesting.	Full sun to partial shade. Will grow in dry areas.
Common Spice Bush <i>(Lindera benzoin)</i>	3,4,5	Dec. Shrub	yes	yes	Very high. Songbirds	Shade and rich soils. Tolerates acidic soils. Good understory species

Table H.5 Native Plant Guide for Stormwater Management Areas (NY)						
Plant Name	Zone	Form	Available	Inundation Tolerance	Wildlife Value	Notes
Eastern Cottonwood <i>(Populus deltoides)</i>	4,5	Dec. Tree	yes	yes	Moderate. Cover, food.	Shallow rooted, subject to windthrow. Invasive roots. Rapid growth.
Eastern Hemlock <i>(Tsuga canadensis)</i>	5,6	Conif Tree	yes	yes	Moderate. Mostly cover and some food	Tolerates all sun/shade conditions. Tolerates acidic soil.
Eastern Red Cedar <i>(Juniperus virginiana)</i>	4,5,6	Conif Tree	yes	no	High. Fruit for birds. Some cover.	Full sun to partial shade. Common in wetlands, shrub bogs and edge of stream
Elderberry <i>(Sambucus canadensis)</i>	3,4,5,6	Dec. Shrub	yes	yes	Extremely high. Food and cover, birds and mammals.	Full sun to partial shade.
Green Ash, Red Ash <i>(Fraxinus pennsylvanica)</i>	4,5	Dec. Tree	yes	yes	Moderate. Songbirds.	Rapid growing streambank stabilizer. Full sun to partial shade.
Hackberry <i>(Celtis occidentalis)</i>	5,6	Dec. Tree	yes	some	High. Food and cover	Full sun to partial shade.
Larch, Tamarack <i>(Larix laricina)</i>	3,4	Conif Tree	no	yes	Low. Nest tree and seeds.	Rapid initial growth. Full sun, acidic boggy soil.
Pin Oak <i>(Quercus palustris)</i>	3,4,5,6	Dec. Tree	yes	yes	High. Tolerates acidic soil	Gypsy moth target. Prefers well drained, sandy soils.
Red Choke Berry <i>(Pyrus arbutifolia)</i>	3,4,5	Dec. Shrub	no	yes	Moderate. Songbirds.	Bank stabilizer. Partial sun.
Red Maple <i>(Acer rubrum)</i>	3,4,5,6	Dec. Tree	yes	yes	High seeds and browse. Tolerates acidic soil.	Rapid growth.
River Birch <i>(Betula nigra)</i>	3,4,5	Dec. Tree	yes	yes	Low. Good for cavity nesters.	Bank erosion control. Full sun.
Shadowbush, Serviceberry <i>(Amelanchier)</i>	4,5,6	Dec. Shrub	yes	yes	High. Nesting, cover, food. Birds and	Prefers partial shade. Common in forested

Table H.5 Native Plant Guide for Stormwater Management Areas (NY)						
Plant Name	Zone	Form	Available	Inundation Tolerance	Wildlife Value	Notes
<i>canadensis</i>					mammals.	wetlands and upland woods.
Silky Dogwood ( <i>Cornus amomium</i> )	3,4,5	Dec. Shrub	yes	yes	High. Songbirds, mammals.	Shade and drought tolerant. Good bank stabilizer.
Slippery Elm ( <i>Ulmus rubra</i> )	3,4,5	Dec. Tree	rare	yes	High. Food (seeds, buds) for birds & mammals (browse). Nesting	Rapid growth, no salinity tolerance. Tolerant to shade and drought.
Smooth Alder ( <i>Alnus serrulata</i> )	3,4,5	Dec. Tree	no	yes	High. Food, cover.	Rapid growth. Stabilizes streambanks.
Speckled Alder ( <i>Alnus rugosa</i> )	3,4	Dec. Shrub	yes	yes	High. Cover, browse for deer, seeds for bird.	
Swamp White Oak ( <i>Quercus bicolor</i> )	3,4,5	Dec. Tree	yes	yes	High. Mast	Full sun to partial shade. Good bottomland tree.
Swamp Rose ( <i>Rosa Palustris</i> )	3,4	Dec. Shrub		Irregular, seasonal, or regularly saturated	High. Food (hips) for birds including turkey, ruffed grouse and mammals. Fox cover.	Prefers full sun. Easy to establish. Low salt tolerance.
Sweetgum ( <i>Liquidambar styraciflua</i> )	4,5,6	Dec. Tree	yes	yes	Moderate. Songbirds	Tolerates acid or clay soils. Sun to partial shade.
Sycamore ( <i>Platanus occidentalis</i> )	4,5,6.	Dec. Tree	yes	yes	Low. Food, cavities for nesting.	Rapid growth. Common in floodplains and alluvial woodlands.
Tulip Tree ( <i>Liriodendron tulipifera</i> )	5,6	Dec. Tree	yes	no	Moderate. Seeds and nest sites	Full sun to partial shade. Well drained soils. Rapid growth.
Tupelo ( <i>Nyssa sylvatica vari biflora</i> )	3,4,5	Dec. Tree	yes	yes	High. Seeds and nest sites	Ornamental



Table H.5 Native Plant Guide for Stormwater Management Areas (NY)						
Plant Name	Zone	Form	Available	Inundation Tolerance	Wildlife Value	Notes
White Ash ( <i>Fraxinus americana</i> )	5,6	Dec. Tree	yes	no	High. Food	All sunlight conditions. Well drained soils.
Winterberry ( <i>Ilex verticillata</i> )	3,4,5	Dec. Shrub	yes	yes	High. Cover and fruit for birds. Holds berries into winter.	Full sun to partial shade. Seasonally flooded areas.
Witch Hazel ( <i>Hamamelis virginiana</i> )	4,5	Dec. Shrub	yes	no	Low. Food for squirrels, deer, and ruffed grouse.	Prefers shade. Ornamental.
<b>Herbaceous Plants</b>						
Arrow arum ( <i>Peltandra virginica</i> )	2,3	Emergent	yes	up to 1 ft.	High. Berries are eaten by wood ducks.	Full sun to partial shade.
Arrowhead, Duck Potato ( <i>Sagittaria latifolia</i> )	2,3	Emergent	yes	up to 1 ft.	Moderate. Tubers and seeds eaten by ducks.	Aggressive colonizer.
Big Bluestem ( <i>Andropogon gerardi</i> )	4,5	Perimeter	yes	Irregular or seasonal inundation.	High. Seeds for songbirds. Food for deer	Requires full sun.
Birdfoot deervetch ( <i>Lotus Corniculatus</i> )	4,5,6	Perimeter	yes	Infrequent inundation	High. Food for birds.	Full sun. Nitrogen fixer.
Blue Flag Iris ( <i>Iris versicolor</i> )	2,3	Emergent	yes	Regular or permanently, up to ½ ft or saturated	Moderate. Food muskrat and wildfowl. Cover, marshbirds	Slow growth. Full sun to partial shade. Tolerates clay. Fresh to moderately brackish water.
Blue Joint ( <i>Calamagrotis canadensis</i> )	2,3,4	Emergent	yes	Regular or permanent inundation up to 0.5 ft.	Moderate. Food for game birds and moose.	Tolerates partial shade
Broomsedge ( <i>Andropogon virginicus</i> )	2,3	Perimeter	yes	up to 3 in.	High. Songbirds and browsers. Winter food and cover.	Tolerant of fluctuation water levels & partial shade.
Bushy Beardgrass ( <i>Andropogon glomeratus</i> )	2,3	Emergent	yes	up to 1 ft.		Requires full sun.
Cardinal flower ( <i>Lobelia cardinalis</i> )	4,5,6	Perimeter	yes	Some. Tolerates saturation up to 100% of season.	High. Nectar for hummingbird, oriole, butterflies.	Tolerates partial shade

Table H.5 Native Plant Guide for Stormwater Management Areas (NY)						
Plant Name	Zone	Form	Available	Inundation Tolerance	Wildlife Value	Notes
Cattail ( <i>Typha sp.</i> )	2,3	Emergent	yes	up to 1 ft.	Low. Except as cover	Aggressive. May eliminate other species. Volunteer. High pollutant treatment
Coontail ( <i>Ceratophyllum demersum</i> )	1	Submergent	no	yes	Low food value. Good habitat and shelter for fish and invertebrates.	Free floating SAV. Shade tolerant. Rapid growth.
Common Three-Square ( <i>Scirpus pungens</i> )	2	Emergent	yes	up to 6 in.	High. Seeds, cover. Waterfowl and fish.	High metal removal.
Duckweed ( <i>Lemna sp.</i> )	1,2	Submergent/ Emergent	yes	yes	High. Food for waterfowl and fish.	High metal removal.
Fowl mannagrass ( <i>Glyceria striata</i> )	4,5	Perimeter	yes	Irregular or seasonal inundation	High. Food for waterfowl, muskrat, and deer.	Partial to full shade.
Hardstem Bulrush ( <i>Scirpus acutus</i> )	2	Emergent	yes	up to 3 ft.	High. Cover, food (achenes, rhizomes) ducks, geese, muskrat, fish. Nesting for bluegill and bass.	Quick to establish, fresh to brackish. Good for sediment stabilization and erosion control.
Giant Burreed ( <i>Sparganium eurycarpum</i> )	2,3	Emergent	rare	Regular to permanently inundated. up to 1 ft.	High. Food (seeds, plant) waterfowl, beaver & other mammals. Cover for marshbirds, waterfowl.	Rapid spreading. Tolerates partial sun. Good for shoreline stabilization.. Salinity <0.5 ppt
Lizard's Tail ( <i>Saururus cernuus</i> )	2	Emergent	yes	up to 1 ft.	Low, except wood ducks.	Rapid growth. Shade tolerant
Long-leaved Pond Weed ( <i>Potamogeton nodosus</i> )	1,2	Rooted submerged aquatic	yes	up to 1-6 ft. depending on turbidity	High. Food (seeds, roots) waterfowl, aquatic fur-bearers, deer, moose. Habitat for fish	Rapid spread. Salinity <0.5 ppt. Flowers float on surface, Aug.-Sept.

Table H.5 Native Plant Guide for Stormwater Management Areas (NY)						
Plant Name	Zone	Form	Available	Inundation Tolerance	Wildlife Value	Notes
Marsh Hibiscus ( <i>Hibiscus moscheutos</i> )	2,3	Emergent	yes	up to 3 in.	Low. Nectar.	Full sun. Can tolerate periodic dryness.
Pickernelweed ( <i>Pontederia cordata</i> )	2,3	Emergent	yes	up to 1 ft.	Moderate. Ducks. Nectar for butterflies.	Full sun to partial shade.
Pond Weed, Sago ( <i>Potamogeton pectinatus</i> )	1	Submergent	yes	yes	Extremely high. Waterfowl, marsh and shorebirds.	Removes heavy metals.
Redtop ( <i>Agrostis alba</i> )	3,4,5	Perimeter	yes	Up to 25% of season	Moderate. Rabbits and some birds.	Quickly established but not highly competitive.
Rice Cutgrass ( <i>Leersia oryzoides</i> )	2,3	Emergent	yes	up to 3 in.	High. Food and cover.	Full sun although tolerant of shade. Shoreline stabilization.
Sedges ( <i>Carex spp.</i> )	2,3	Emergent	yes	up to 3 in.	High waterfowl, songbirds.	Many wetland and upland species.
Tufted Hairgrass ( <i>Deschampsia caespitosa</i> )	3,4,5	Perimeter	yes	Regular to irregular inundation.	High.	Full sun. May become invasive.
Soft-stem Bulrush ( <i>Scirpus validus</i> )	2,3	Emergent	yes	up to 1 ft.	Moderate. Good cover and food.	Full sun. Aggressive colonizer. High pollutant removal.
Smartweed ( <i>Polygonum spp.</i> )	2,3,4	Emergent	yes	up to 1 ft.	High. Waterfowl, songbirds. Seeds and cover.	Fast colonizer. Avoid weedy aliens such as <i>P. perfoliatum</i> .
Soft Rush ( <i>Juncus effusus</i> )	2,3,4	Emergent	yes	up to 3 in.	Moderate.	Tolerates wet or dry conditions.
Spatterdock ( <i>Nuphar luteum</i> )	2	Emergent	yes	up to 3 ft.	Moderate for food but high for cover.	Fast colonizer. Tolerant of fluctuating water levels.
Switchgrass ( <i>Panicum virgatum</i> )	2,3,4,5,6	Perimeter	yes	up to 3 in.	High. Seeds, cover for waterfowl, songbirds.	Tolerates wet/dry conditions.

<b>Table H.5 Native Plant Guide for Stormwater Management Areas (NY)</b>						
<b>Plant Name</b>	<b>Zone</b>	<b>Form</b>	<b>Available</b>	<b>Inundation Tolerance</b>	<b>Wildlife Value</b>	<b>Notes</b>
Sweet Flag <i>(Acorus calamus)</i>	2,3	Herbaceous	yes	up to 3 in.	Low.	Tolerant of dry periods. Not a rapid colonizer. Tolerates acidic conditions.
Waterweed <i>(Elodea canadensis)</i>	1	Submergent	yes	yes	Low.	Good water oxygenator. High nutrient, copper, manganese and chromium removal.
Wild Celery <i>(Valisneria americana)</i>	1	Submergent	yes	yes	High. Food for waterfowl. Habitat for fish and invertebrates.	Tolerant of murky water and high nutrient loads.
Wild Rice <i>(Zizania aquatica)</i>	2	Emergent	yes	up to 1 ft.	High. Food for birds.	Prefers full sun
Wool Grass <i>(Scirpus cyperinus)</i>	2,3	Emergent	yes	Irregularly to seasonally inundated	Moderate. Cover, Food.	Requires full sun. Can tolerate acidic soils, drought. Colonizes disturbed areas, moderate growth.

# Appendix I

New York State Stormwater Management Design Manual

R0080514

## Appendix I. Sizing Criteria

Traditional SMP sizing criteria are based on the hydrology and climatic conditions of moderate climates. These criteria are not always applicable to cold climate regions due to snowmelt, rain-on-snow and frozen soils. This chapter identifies methods to adjust both water quality (Section I.1) and water quantity (Section I.2) sizing criteria for cold climates.

### I.1 Water Quality Sizing Criteria

The water quality volume is the portion of the SMP reserved to treat stormwater either through detention, filtration, infiltration or biological activity. Base criteria developed for SMP sizing nationwide are based on rainfall events in moderate climates (e.g., Schueler, 1992). Designers may wish to increase the water quality volume of SMPs to account for the unique conditions in colder climates, particularly when the spring snowfall represents a significant portion of the total rainfall. Spring snowmelt, rain-on-snow and rain-on-frozen ground may warrant higher treatment volumes. It is important to note that **the base criteria required by a region must always be met**, regardless of calculations made for cold climate conditions.

Figure I.1 Increased Water Quality Volume in Cold Climates

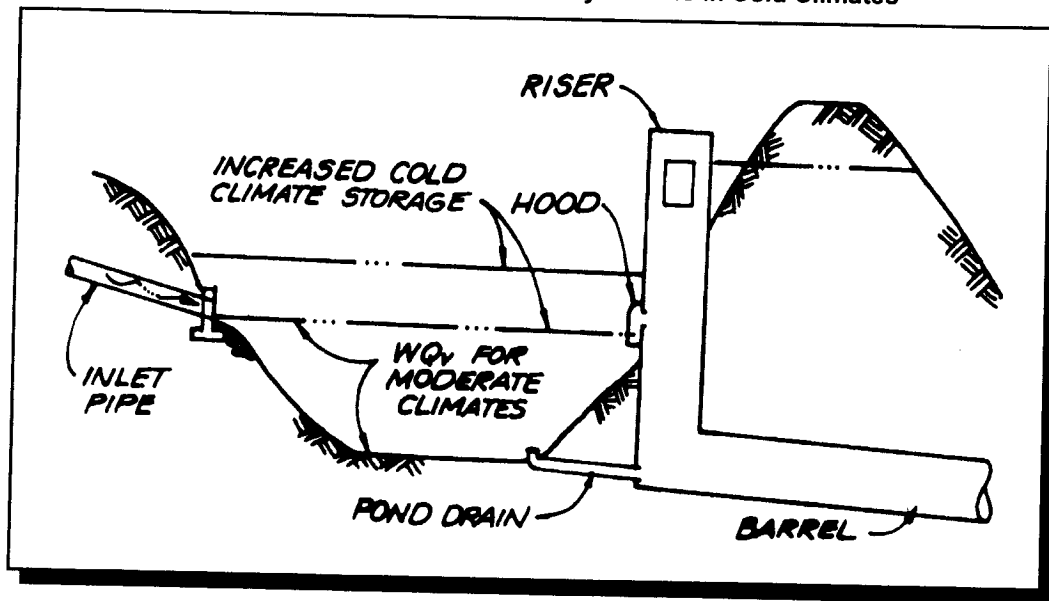

The goal of treating 90% of the annual pollutant load (Schueler, 1992), can be applied to snowmelt runoff and rain-on-snow events. In the following conditions, cold climate sizing may be greater than base criteria sizing:

- Snowfall represents more than 10% of total annual precipitation. This value is chosen because, at least some portion of the spring snowmelt needs to be treated in order to treat 90% of annual runoff in these conditions. Using the rule of thumb that the moisture content of snowfall has about 10% moisture content, this rule can be simplified as:

*Oversize when average annual snowfall depth is greater than or equal to annual precipitation depth.*

- The area is in a coastal or Great Lakes region with more than 3' of snow annually. In these regions, rain-on-snow events occur frequently enough to justify oversizing stormwater SMPs for water quality.

The following caveats apply to the sizing criteria presented in this section:

- These criteria are not appropriate for very deep snowpacks (i.e., greater than 4') because the volume to be treated would be infeasible, and often unnecessary.
- Sizing for snow storage areas is described in Appendix C.
- Snowmelt is a complicated process, with large annual variations. While the criteria presented here address the

affects of snowmelt and rain-on-snow, several simplifying assumptions are made. Where local data or experience are available, more sophisticated methods should be substituted.

### ***1.1.1 Water Quality Volume for Snowmelt***

In order to treat 90% of annual runoff volume, sizing for snowmelt events needs to be completed in the context of the precipitation for the entire year. In relatively dry regions that receive much of their precipitation as snowfall, the sizing is heavily influenced by the snowmelt event. On the other hand, in regions with high annual rainfall, storm events are more likely to carry the majority of pollutants annually. The sizing criteria for this section are based on three assumptions: 1) SMPs should be sized to treat the spring snowmelt event 2) Snowmelt runoff is influenced by the moisture content of the spring snowpack and soil moisture 3) No more than five percent of the annual runoff volume should bypass treatment during the spring snowmelt event and 4) SMPs can treat a snowmelt volume greater than their size.

- *SMPs should be sized to treat the spring snowmelt runoff event*

Snowmelt occurs throughout the winter in small, low-flow events. These events have high concentrations of soluble pollutants such as chlorides and metals, because of “preferential elution” from the snowpack (Jeffries, 1988). Although these events have significant pollutant loads, the flows are very low intensity, and generally will not affect SMP sizing decisions.

The spring snowmelt, on the other hand, is higher in suspended solids and hydrophobic elements, such as hydrocarbons, which can remain in the snowpack until the last five to ten percent of water leaves the snowpack (Marsalek, 1991). In addition, a large volume of runoff occurs over a comparatively short period of time (i.e., approximately two weeks). Most SMPs rely on settling to treat pollutants, and the pollutants carried in the spring snowmelt are more easily treated by these mechanisms. In addition, the large flow volume during this event may be the critical water quality design event in many cold regions.

- *Snowmelt runoff is influenced by the moisture content of the spring snowpack and soil moisture*

Because of small snowmelt events that occur throughout the winter, losses through sublimation, and management practices such as hauling snow to other locations, the snowpack only contains a fraction of the moisture from the winter snowfall. Thus, the remaining moisture in the snowpack can be estimated by:

$$M=0.1 \cdot S-L_1-L_2-L_3 \quad \text{Equation I.1}$$

Where:

M=Moisture in the Spring Snowpack (inches)

S=Annual Snowfall (inches)

L<sub>1</sub>, L<sub>2</sub> and L<sub>3</sub> = Losses to Hauling, Sublimation and Winter Melt, respectively.

The volume of snow hauled off site can be determined based on available information on current plowing practices. In New York, sublimation to the atmosphere is not very important

The design examples in this section use a simple “rule of thumb” approach, to estimate winter snowmelt for simplicity (Table I.1). The method assumes that winter snowmelt is influenced primarily by temperature, as represented by the average daily temperature for January. One half of the snow (adjusted for plowing and sublimation) is assumed to melt during the winter in very cold regions (Average T<sub>max</sub> <25 °F) and two thirds is assumed to melt during the winter in moderately cold regions (Average T<sub>max</sub> <35 °F). Winter snowmelt can be estimated using several methods, such as the simple degree-day method, or through more complex continuous modeling efforts.

**Table I.1 Winter Snowmelt\***

Adjusted Snowfall Moisture Equivalent	Winter Snowmelt (January T <sub>max</sub> <25°F)	Winter Snowmelt (January T <sub>max</sub> <35°F)
2"	1.0"	1.3"
4"	2.0"	2.7"
6"	3.0"	4.0"
8"	4.0"	5.3"
10"	5.0"	6.7"
12"	6.0"	8.0"

\* Snowmelt occurring before the spring snowmelt event, based on the moisture content in the annual snowfall. The value in the first column is adjusted for losses due to sublimation and plowing off site.

Snowmelt is converted to runoff when the snowmelt rate exceeds the infiltration capacity of the soil. Although the rate of snowmelt is slow compared with rainfall events, snowmelt can cause significant runoff because of frozen soil conditions. The most important factors governing the volume of snowmelt runoff are the water content of the snowpack and the soil moisture content at the time the soil freezes (Granger et al., 1984). If the soil is relatively dry when it freezes, its permeability is retained. If, on the other hand, the soil is moist or saturated, the ice formed within the soil matrix acts as an impermeable layer, reducing infiltration. Section I.1.3 outlines a methodology for computing snowmelt runoff based on this principle.

- *No more than 5% of the annual runoff volume should bypass treatment during spring snowmelt* In order to treat 90% of the annual runoff volume, at least some of the spring snowmelt, on average, will go un-treated. In addition, large storm events will bypass treatment during warmer months. Limiting the volume that bypasses treatment during the spring snowmelt to 5% of the annual runoff volume allows for these large storm events to pass through the facility untreated, while retaining the 90% treatment goal.

The resulting equation is:

$$T = (R_s - 0.05R)A/12 \quad \text{(Equation I.2)}$$

Where:

- T = Volume Treated (acre-feet)
- R<sub>s</sub> = Snowmelt Runoff [See Section I.1.3]
- R = Annual Runoff Volume (inches) [See Section I.1.2]
- A = Area (acres)

- *SMPs can treat a volume greater than their normal size.*

Snowmelt occurs over a long period of time, compared to storm events. Thus, the SMP does not have to treat the entire water quality treatment volume computed over twenty four hours, but over a week or more. As a result, the necessary water quality volume in the structure will be lower than the treatment volume. For this manual, we have assumed a volume of ½ of the value of the computed treatment volume (T) calculated in equation I.2.

Thus,

$$WQ_v = \frac{1}{2} T \quad \text{(Equation I.3)}$$

**I.1.2 Base Criteria/ Annual Runoff**

The base criterion is the widely-used, traditional water quality sizing rule. This criterion, originally developed for moderate climates, represents the minimum recommended water quality treatment volume. In this manual, the runoff from a one inch rainfall event is used as the base criteria. The basis behind this sizing criteria is that approximately 90% of the storms are treated using this event. This value may vary nationwide, depending on local historical rainfall frequency distribution data. However, the one inch storm is used as a simplifying assumption. The base criteria included in this manual is chosen because it incorporates impervious area in the sizing of urban SMPs, and modifications are used nationwide. The cold climate sizing modifications used in this manual may be applied to any



base criteria, however.

Runoff for rain events can be determined based on the Simple Method (Schueler, 1987).

$$r = p(.05 + .9I) \quad \text{(Equation I.4)}$$

Where:  $r$  = Event Rainfall Runoff (inches)

$p$  = Event Precipitation (inches)

$I$  = Impervious Area Fraction

Thus, the water quality volume for the base criteria can be determined by:

$$WQ_v = (0.05 + .9I) A / 12 \quad \text{(Equation I.5)}$$

Where:  $WQ_v$  = Water Quality Volume (acre-feet)

$I$  = Impervious Fraction

$A$  = Area (acres)

The Simple Method can also be used to determine the annual runoff volume. An additional factor,  $P_j$ , is added because some storms do not cause runoff. Assume  $P_j = 0.9$  (Schueler, 1987). Therefore, annual runoff volume from rain can be determined by:

$$R = 0.9 P (0.05 + .9I) \quad \text{(Equation I.6)}$$

Where:  $R$  = Annual Runoff (inches)

$P$  = Annual Rainfall (inches)

### ***1.1.3 Calculating the Snowmelt Runoff***

To complete water quality sizing, it is necessary to calculate the snowmelt runoff. Several methods are available, including complex modeling measures. For the water quality volume, however, simpler sizing methods can be used since the total water quality volume, not peak flow, is critical. One method, modified from Granger et al. (1984) is proposed here. Other methods can be used, particularly those adjusted to local conditions.

According to Granger et al. (1984) the infiltration into pervious soils is primarily based on the saturation of the soils prior to freezing. While saturated soils allow relatively little snowmelt to infiltrate, dry soils have a high capacity for infiltration. Thus, infiltration volumes vary between wet, moderate and dry soil conditions (Figure I.2).

**Figure I.2 Snowmelt Infiltration Based on Soil Moisture**

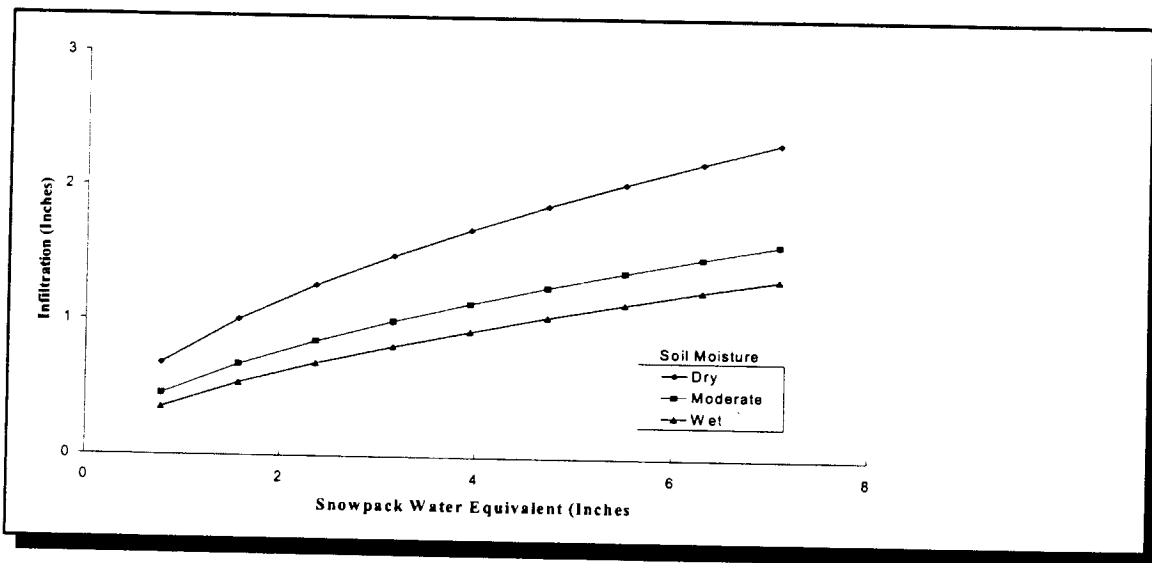

Assume also that impervious area produces 100% runoff. The actual percent of snowmelt converted to runoff from impervious areas such as roads and sidewalks may be less than 100% due to snow removal, deposition storage and sublimation. However, stockpiled areas adjacent to paved surfaces often exhibit increased runoff rates because of the high moisture content in the stockpiled snow (Buttle and Xu, 1988). This increased contribution from pervious areas off-sets the reduced runoff rates from cleared roads and sidewalks.

The resulting equation to calculate snowmelt runoff volume based on these assumptions is:

$$R_s = [\text{runoff generated from the pervious areas}] + [\text{runoff from the impervious areas}]$$

$$R_s = [(1 - I)(M - \text{Inf})] + [(I)(1)(M)] \quad (\text{Equation I.7})$$

where:

- $R_s$  = Snowmelt Runoff
- $I$  = Impervious Fraction
- $M$  = Snowmelt (inches)
- $\text{Inf}$  = Infiltration (inches)

**Sizing Example 1: Snowpack Treatment**

- Scenario:**
- 50 Acre Watershed
  - 40% Impervious Area
  - Average Annual Snowfall= 5'=60"
  - Average Daily Maximum January Temperature= 20°
  - Average Annual Precipitation = 30"
  - 20% of snowfall is hauled off site
  - Sublimation is not significant
  - Prewinter soil conditions: moderate moisture.

**Sizing Example 1: Snowpack Treatment**

**Step 1:** Determine if oversizing is necessary  
Since the average annual precipitation is only ½ of average annual snowfall depth, oversizing is needed.

**Step 2:** Determine the annual losses from sublimation and snow plowing.  
Since snow hauled off site is about 20% of annual snowfall, the loss from snow hauling,  $L_1$ , can be estimated by:

$$L_1 = (0.2)(0.1)S$$

Where:  $L_1$  = Water equivalent lost to hauling snow off site (inches)

$S$  = Annual snowfall (inches)

0.1 = Factor to convert snowfall to water equivalent

Therefore, the loss to snow hauling is equal to:

$$L_1 = (0.2)(0.1)(60")$$

$$L_1 = 1.2"$$

Since sublimation is negligible,  $L_2 = 0$

**Step 3:** Determine the annual water equivalent loss from winter snowmelt events  
Using the information in Step 2, the moisture equivalent in the snowpack remaining after hauling is equal to:

$$60" \cdot 0.1 - 1.2" = 4.8"$$

Substituting this value into Table I.1, and interpolating, find the volume lost to winter melt,  $L_3$ .

$$L_3 = 2.4"$$

**Step 4:** Calculate the final snowpack water equivalent,  $M$

$$M = 0.1 \cdot S - L_1 - L_2 - L_3 \quad (\text{Equation I.1})$$

$$S = 60"$$

$$L_1 = 1.2"$$

$$L_2 = 0"$$

$$L_3 = 2.4"$$

Therefore,  $M = 2.4"$

**Step 5:** Calculate the snowmelt runoff volume,  $R_s$

$$R_s = (1-I)(M - \text{Inf}) + I \cdot M \quad \text{Equation I.7}$$

$$M = 2.4"$$

$$I = 0.4$$

$$\text{Inf} = 0.8" \quad (\text{From figure I.2; assume average moisture})$$

$$\text{Therefore, } R_s = 1.9"$$

**Step 6:** Determine the annual runoff volume,  $R$

Use the Simple Method to calculate rainfall runoff:

$$R = 0.9(0.05 + 0.9 \cdot I)P \quad (\text{Equation I.6})$$

$$I = 0.4$$

$$P = 30"$$

$$\text{Therefore, } R = 11"$$

**Sizing Example 1: Snowpack Treatment**

- Step 7:** Determine the runoff to be treated  
Treatment, T should equal:  
 $T = (R_s - 0.05 * R) A / 12$  (Equation I.2)  
 $R_s = 1.9"$   
 $R = 11"$   
 $A = 50$  Acres  
 Therefore,  $T = 5.6$  acre-feet
- Step 8:** Size the SMP  
 The volume treated by the base criteria would be:  
 $WQ_v = (.05 + .9 * .4)(1/12")(50 \text{ acres}) = 1.7$  acre-feet (Equation I.5)
- For cold climates:  
 $WQ_v = 1/2(T) = 2.8$  acre-feet (Equation I.3)  
 The cold climate sizing criteria is larger, and should be used to size the SMP.

**1.1.4 Rain-on-Snow Events**

For water quality volume, an analysis of rain-on-snow events is important in coastal regions. In non-coastal regions, rain-on-snow events may occur annually but are not statistically of sufficient volume to affect water quality sizing, especially after snowpack size is considered. In coastal regions, on the other hand, flooding and annual snowmelt are often driven by rain-on-snow events (Zuzel et al., 1983). Nearly 100% of the rain from rain-on-snow events and rain immediately following the spring melt is converted to runoff (Bengtsson, 1990). Although the small rainfall events typically used for SMP water quality do not produce a significant amount of snowmelt (ACOE, 1956), runoff produced by these events is high because of frozen and saturated ground under snow cover.

Many water quality volume sizing rules are based on treating a certain frequency rainfall event, such as treating the 1-year, 24-hour rainfall event. The rationale for treating 90% of the pollutant load (Schueler, 1992) can also be applied to rain-on-snow events, as shown in the following example.

**Sizing Example 2: Rain-on-Snow**

- Step 1:** Develop a rain-on-snow data set.  
 Find all the rainfall events that occur during snowy months. Rainfall from December through April were included. Please note that precipitation data includes both rainfall and snowfall, and only data from days without snowfall should be included. Exclude non-runoff-producing events (less than 0.1"). Some of these events may not actually occur while snow is on the ground, but they represent a fairly accurate estimate of these events.
- Step 2:** Calculate a runoff distribution for rain-on-snow events  
 Since rain-on-snow events contribute directly to runoff, the runoff distribution is the same as the precipitation distribution in Figure I.3.

**Sizing Example 2: Rain-on-Snow**

**Figure I.3 Rainfall Distribution for Snowy Months**

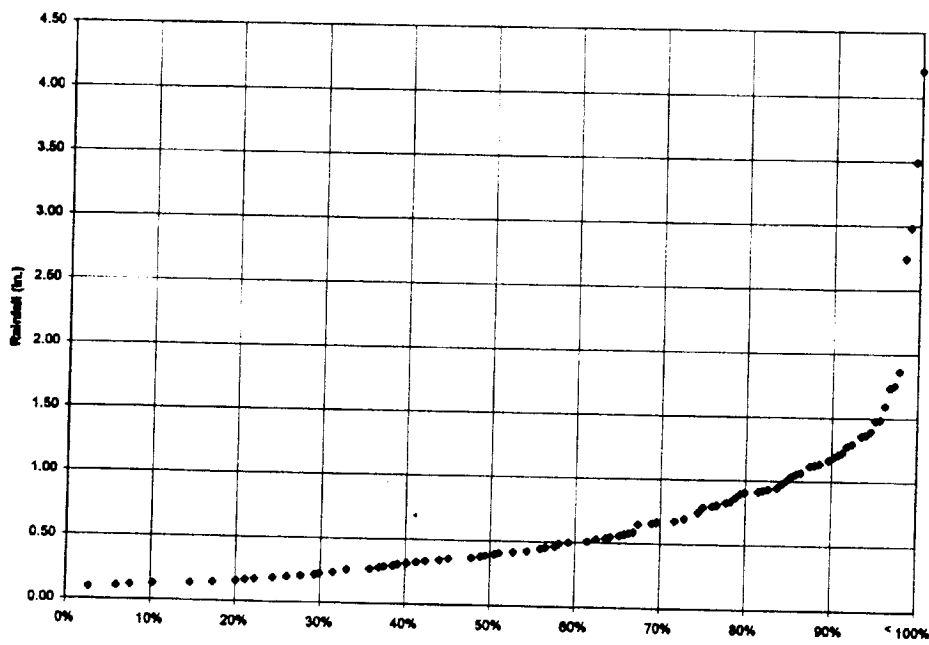

**Step 3:**

Calculate a rainfall distribution for non-snow months.  
 Develop a distribution of rainfall for months where snow is not normally on the ground. The rainfall distribution for May through November is included in Figure I.4.

**Sizing Example 2: Rain-on-Snow**

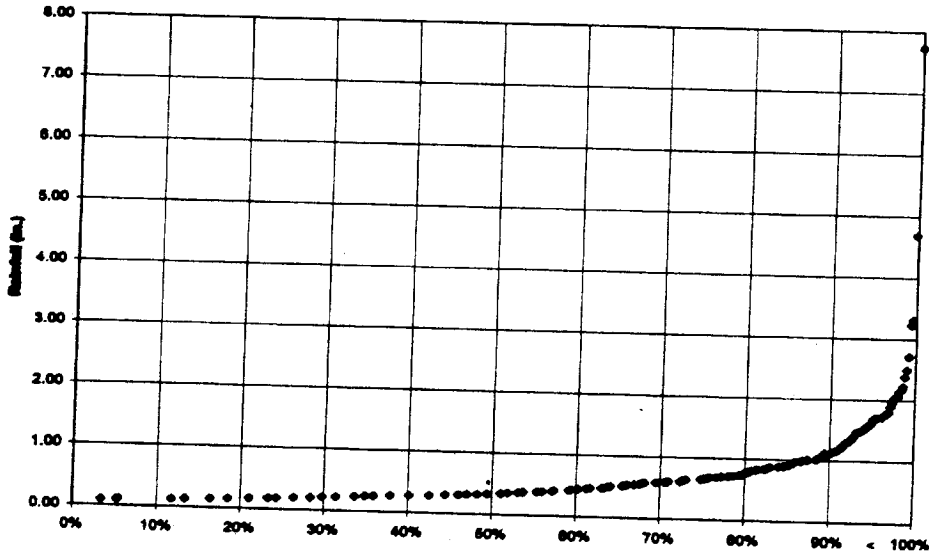

Figure

**Rainfall Distribution for Non-Snowy Months**

I.4

**Step 4:**

Calculate the runoff distribution for non-snow months.

Use a standard method to convert rainfall to runoff, particularly methods that are calibrated to local conditions. For this example, use the Simple Method. Runoff is calculated as:

$$r = (0.05 + 0.9 I)p \quad \text{(Equation I.4)}$$

For this example,  $I = 0.3$  (30% impervious area), so:

$$r = 0.32 p$$

The runoff distribution for non-snow months is calculated by multiplying the rainfall in Figure I.4 by 0.32.

**Step 5:**

Combine the runoff distributions calculated in Steps 2 and 4 to produce an annual runoff distribution. The resulting runoff distribution (Figure I.5) will be used to calculate the water quality volume.

**Sizing Example 2: Rain-on-Snow**

**Figure I.5 Annual Runoff Distribution**

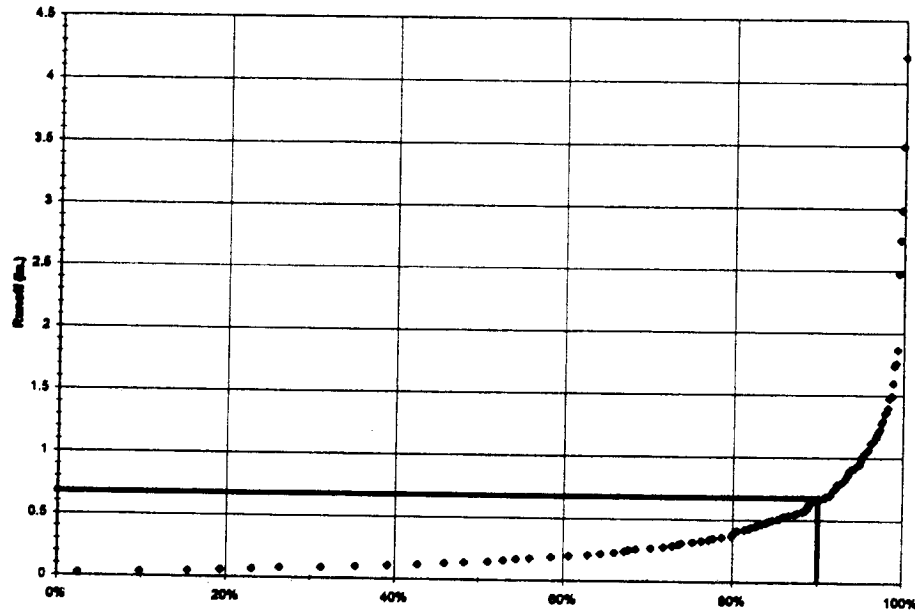

**Step 6:**

Size the SMP.

In this case, use the 90% frequency runoff event (Figure I.4), or 0.65 watershed inches. This value is greater than the base criteria of 0.32 watershed inches (1" storm runoff). Therefore, the greater value is used.

$$WQ_v = (0.65 \text{ inches}) (1 \text{ foot}/12 \text{ inches}) (50 \text{ acres}) = 2.7 \text{ acre-feet}$$

**References**

- Army Corps of Engineers (ACOE), North Pacific Division. 1956. Snow Hydrology, Summary Report of the Snow Investigations. Portland, OR.
- Bengtsson, L. 1990. Urban Snow Hydrology. *Proceedings of an International Conference on Urban Hydrology Under Wintry Conditions*. Narvik, Norway.
- Buttle, J. and F. Xu. 1988. Snowmelt Runoff in Suburban Environments. *Nordic Hydrology*, 19:19-40.
- Granger, R., D. Gray and D. Dyck. 1984. Snowmelt Infiltration to frozen Prairie Soils. *Canadian Journal of Earth Science*, 21:669-677
- Jeffries, D. 1988. Snowpack Release of Pollutants. National Water Research Institute, Report No. 88-06. Burlington, ON, Canada.
- Marsalek, J. 1991. Urban Drainage in Cold Climates: Problems, Solutions and Research Needs. IN: *New Technologies in Urban Drainage*. Elsevier Applied Science. New York, N.Y.
- Schueler, T. 1992. *Design of Stormwater Wetland Systems*. Metropolitan Washington Council of Governments. Washington, DC.
- Schueler, T. 1987. Controlling Urban Runoff: A Practical Manual for Planning and Designing Urban Best Management Practices. Metropolitan Washington Council of Governments. Washington, D.C.
- Zuzel, J., R. Greewalt, and R.R. Allmaras. 1983. Rain on Snow: Shallow, Transient Snowpacks with Frozen Soils. *Proceedings of the Western Snow Conference*. pp. 67-75.



# Appendix J

New York State Stormwater Management Design Manual

R0080526

## Appendix J: Geomorphic Assessment

### Distributed Runoff Control Methodology Pond Outlet Structure Design Example

The following design example illustrates a step-by-step methodology for the design of a weir for the control of in-stream erosion potential using a Stormwater Management (SWM) wet pond design based on the Distributed Runoff Control (DRC) approach. The DRC approach incorporates boundary material composition and its sensitivity to erosion (entrainment and transport) into the design protocol. The boundary materials are characterized at the point of maximum boundary shear stress on the bed and the point of secondary maximum boundary shear stress on the bank. By examining the channel at selected sites downstream of the SWM facility the DRC protocol provides a pseudo 3-dimensional assessment of the impact of development and the SWM facility on the receiving channel.

This design example involves 5 Steps as listed in Table J.1.

Table J.1 Overview of Key Steps in the DRC Design Approach	
1)	Determine the “stability” and “mode-of-adjustment” of the receiving channel
2)	Complete a Diagnostic Geomorphic Survey of the receiving channel
3)	Determine channel sensitivity to an alteration in the sediment-flow regime
4)	Approximate the elevation-discharge curve for the pond.
5)	Size the DRC weir

#### Step 1. Determine Channel “Stability” and “Mode-of-Adjustment”

Channel stability is determined using a Rapid Geomorphic Assessment (RGA) of the channel downstream of the outlet of the proposed Stormwater Management (SWM) pond. The RGA protocol involves the identification of the presence of in-stream features resulting from a variety of geomorphic processes to provide a semi-quantitative assessment of a stream's stability and mode-of-adjustment. The processes are represented by four Factors: aggradation (AF), widening (WF), downcutting (DF), and planimetric form adjustment (PF)). Each Factor is composed of 7 to 10 indices for which a “present” or “absent” response is required. The total number of “present” or “yes” responses is summed and divided by the total number of responses (both “yes” and “no”) to derive a value for each Factor. An index that is not relevant is not assigned a response. An example of an RGA Form is provided in Table J.2.

A Stability Index (SI) value is determined from the Factor values using the following equation:

$$SI = \frac{\{AF + DF + WF + PF\}}{m}, \dots \dots \dots [J.1]$$

where ‘m’ is the number of Factors (typically 4 for alluvial streams).

Table J.2 Rapid Geomorphic Assessment Form					
FORM/ PROCESS	GEOMORPHIC INDICATOR		PRESENT		FACTOR VALUE
	No.	Description	No	Yes	
Evidence of Aggradation (AI)	1	Lobate bar	1		1/7=0.143
	2	Coarse material in riffles embedded		1	
	3	Siltation in pools	1		
	4	Medial bars	1		
	5	Accretion on point bars	1		
	6	Poor longitudinal sorting of bed materials	1		
	7	Deposition in the overbank zone	1		
Evidence of Degradation (DI)	1	Exposed bridge footing(s)	-	-	2/6=0.333
	2	Exposed sanitary/storm sewer/pipeline/etc.	-	-	
	3	Elevated stormsewer outfall(s)	-	-	
	4	Undermined gabion baskets/concrete aprons/etc.	-	-	
	5	Scour pools d/s of culverts/stormsewer outlets	1		
	6	Cut face on bar forms	1		
	7	Head cutting due to knick point migration	1		
	8	Terrace cut through older bar material		1	
	9	Suspended armor layer visible in bank		1	
	10	Channel worn into undisturbed overburden/bedrock	1		
Evidence of Widening (WI)	1	Fallen/leaning trees/fence posts/etc.		1	3/10=0.30
	2	Occurrence of Large Organic Debris		1	
	3	Exposed tree roots		1	
	4	Basal scour on inside meander bends	1		
	5	Basal scour on both sides of channel through riffle	1		
	6	Gabion baskets/concrete walls/armor stone/etc. out flanked	1		
	7	Length of basal scour >50% through subject reach	1		
	8	Exposed length of previously buried pipe/cable/etc.	1		
	9	Fracture lines along top of bank	1		
	10	Exposed building foundation	1		
Evidence of Planimetric Form Adjustment (PI)	1	Formation of cutes(s)	1		0/7=0
	2	Evolution of single thread channel to multiple channel	1		
	3	Evolution of pool-riffle form to low bed relief form	1		
	4	Cutoff channel(s)	1		
	5	Formation of island(s)	1		
	6	Thalweg alignment out of phase with meander geometry	1		
	7	Bar forms poorly formed/reworked/removed	1		
STABILITY INDEX (SI) = (AI+DI+WI+PI)/m			SI=		0.19

The Stability Index (SI) provides an indication of the stability of the creek channel at a given time based on the guidelines provided in Table J.3. The SI Value, however, does not differentiate between current and past disturbances.

Table J.3 Interpretation of the RGA Stability Index Value		
Stability Index Value	Stability Class	Description
0.0<SI<0.25	Stable	Metrics describing channel form are within the expected range of variance (typically accepted as one standard deviation from the mean) for stable channels of similar type
0.25<SI<0.4	Transitional	Metrics are within the expected range of variance as defined above but with evidence of stress
0.4<SI<1.0	In Adjustment	Metrics are outside of the expected range of variance for channels of similar type.

The guidelines presented in Table J.3 for the interpretation of the SI Value will vary with the field experience and the bias of the observer. The SI Values however, have been shown to be consistent between observers indicating that the protocol, once calibrated to the observer provides a reliable means of screening the channel for stability and mode-of-adjustment.

The RGA protocol is applied to channel segments of two meanders in length or the equivalent of 20 bankfull channel widths (the width of the channel at the geomorphically dominant discharge, recurrence interval of between 1 and 2 years or 1.5 years on average).

The segment chosen for application of the RGA assessment is selected to be representative of the morphology of the channel for some distance up and downstream of the surveyed segment. That is, the parameters defining channel cross-section and plan form (e.g. width, depth, meander wavelength, etc.) are within a consensual level of variance for this reach of channel. An acceptable level of variance is typically defined as within one standard deviation of the mean. These reaches are referred to as being of "like" morphology. Since the morphology of the channel will vary in the longitudinal direction with changes in flow, slope, physiography, etc., it will be necessary to re-apply the RGA protocol where the parameters characterizing the morphology of the channel have changed beyond the consensual level of variance from the previous survey reach. In this manner the channel is divided into a series of reaches of "like" morphology.

Having determined the length of the survey reach, the longitudinal profile can be plotted from topographic mapping as illustrated in Figure J.1 (Topo). Examination of Figure J.1 (topographic map data) suggests that the channel can be differentiated into three distinct reaches. In the first reach (length L=146 ft, the channel has an average slope of S=0.00385 ft/ft and a meander-pool-riffle morphology. In the middle reach (L=356 ft; S=0.0142 ft/ft) the channel has cascade morphology. The third reach (L≈258 ft; S≈0.00794 ft/ft) returns to the meander-pool-riffle form.

Land use through the study reach is homogeneous (forest) and there are no other features (e.g. bridges, dams, weirs, instream works, etc.) that would affect the hydraulic characteristics of the active channel. Consequently, a preliminary definition of "like" reaches includes the three morphologies described above.

A synoptic geomorphic survey was conducted through the subject reach with an RGA assessment completed for each of the three reaches of "like" morphology. The results of the RGA assessment for the first reach (Reach 1) are reported in Tables J.2 and J.4. Referring to Table J.2, the Stability Index (SI) value was found to be SI=0.19, which is less than 0.25, therefore the channel is considered to be "stable" (Table J.3).

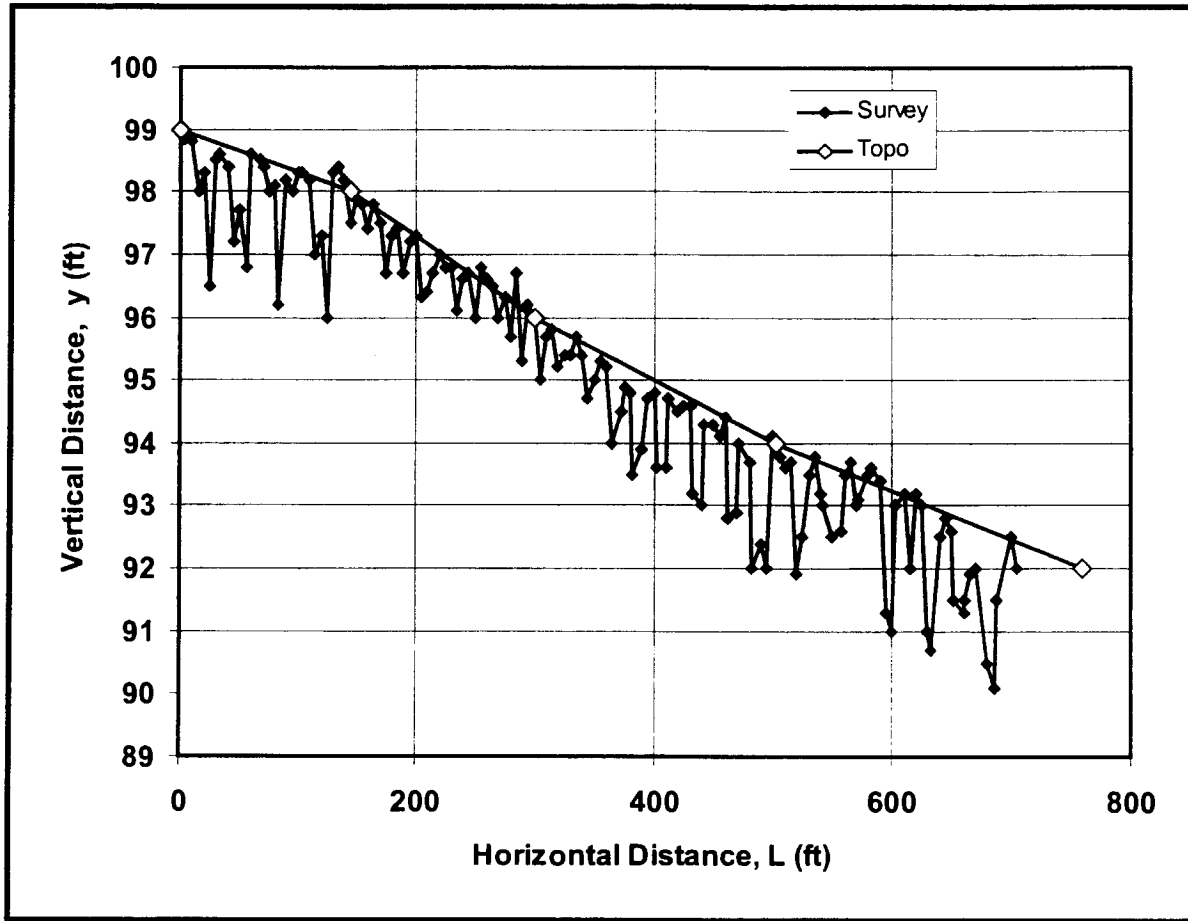

Figure J.1 Longitudinal Profile from Topographic Mapping and Field Survey of Channel Thalweg

Table J.4 Summary of Average Longitudinal Slope and Pool-Riffle Dimensions			
Parameter	Reach 1	Reach 2	Reach 3
Longitudinal Gradient, S (ft/ft)	0.00385	0.0142	0.00794
Riffle Length, LRIF (ft)	16	34	27
Pool Length, LPOL (ft)	37	10	18
Total Pool-Riffle Length, LTOT (ft)	53	44	45

## Step 2. Diagnostic Geomorphic Survey

Following completion of the identification of reaches of “like” morphology and the synoptic survey to finalize the delineation of the “like” reaches, a diagnostic geomorphic survey is undertaken to characterize the morphological attributes of the channel. This information has two primary functions.

1. The optimization of the erosion control benefit of the pond; and,
2. The provision for establishing a baseline condition from which it is possible to assess the performance of the SWM measures.

A detailed diagnostic survey includes a collection of a comprehensive set of parameters to assess and evaluate stream geomorphic conditions. A complete survey is typically required when:

- a) A post-construction monitoring program is mandated; and,
- b) Data are required for the design and construction of instream works.

Only a partial diagnostic survey is needed where the above issues are not relevant to the project. The following lists those parameters required for the partial diagnostic survey:

1. In the absence of flow measurements, a field estimate of Manning’s ‘n’ value is obtained for comparison with sediment computed estimates.
2. Detailed survey of the channel cross-section, including the floodplain, to determine hydraulic geometry metrics at a so called “Master cross-section” and the relative location of bank material strata.
3. The longitudinal profile of the bed along the channel thalweg and the water surface at the time of survey over a distance of one meander wavelength or 10 bankfull widths. These data are used to determine the longitudinal gradient of the channel from riffle crest to riffle crest and to determine the dimensions of the pool-riffle complex.
4. At least one estimate of bankfull depth (the depth of flow at the dominate discharge) at the Master cross-section and all ancillary cross-sections (3 alternative methods are described in this example for illustrative purposes).
5. Bed material characteristics based on pebble counts of the bed material at a riffle crossover. These data are collected to help assess roughness coefficients, bed material resistance, and provide an alternate method for the estimation of bankfull depth.
6. Soil pits in the banks to map bank stratigraphy and to determine bank material composition using soil consistency tests (stickiness, plasticity and firmness) or particle size analysis (percent silt clay) with Atterberg Limits (Plasticity Index) for each stratigraphic unit. These data are required to help assess historic degradation or aggradation patterns and determine bank material resistance.
7. Map riparian vegetation and root zone characteristics in the soil pits for assessment of the affect of root binding on bank material resistance.

The cross-section data and bank material characterization is completed at a Master cross-section within the representative segment of each “like” reach. The Master cross-section is typically located at a riffle crossover on a straight reach between meander bends. Ancillary cross-sections are located in the lower one third of the meander bends and riffle crossover points up and downstream of the Master cross-section. Data collected at the ancillary cross-sections includes a cross-section profile (typically 7 to 9 ordinates) and estimates of bankfull stage. The longitudinal profile is collected throughout the survey segment along with characterization of plan form geometry.

**Design Case: Diagnostic Geomorphic Survey**

The longitudinal survey of the channel along the thalweg is presented in Figure J.1 (“Survey” data points). This profile more clearly demonstrates the differences between the three reaches as represented by slope and pool-riffle dimensions (Table J.4). Other parameter values derived from the geomorphic survey are summarized in Table J.5. These data are combined with the cross-section, soils and sediment data to generate values for key parameters as described in the following series of calculations.

The following calculations are required to determine the 3 different estimates of the dominant discharge.

**Estimate of Geomorphic Referenced Dominant Discharge**

1. The longitudinal data are plotted to generate estimates of the channel gradient in order of priority as follows:
  - (1) Water surface profile based on estimates of bankfull stage from the Master and ancillary cross-sections.
  - (2) Bed slope (riffle crest to riffle crest), and
  - (3) Water surface profile (dry weather flow at the time of the survey).
2. The pebble count data (length, width and breadth) are transformed into an equivalent diameter and used to generate a mass curve wherein cumulative percent finer by mass is plotted as a function of particle diameter;
3. The  $D_{50}$  and  $D_{84}$  particle size values (the particle diameter below which 50 and 84% of the particles are finer by mass, respectively) are determined from the mass curve;
4. Manning’s roughness coefficient is estimated at bankfull stage using:
  - (1) Standard field guides, and
  - (2) Empirical relations such as: the Strickler (1923) and Limerinos (1970) equations.
5. The cross-section ordinates collected at the Master cross-section are plotted to produce a cross-section profile and a stage-area curve;
6. The stage-area curve is combined with the longitudinal gradient (S) and the estimate of Manning’s roughness coefficient (n) to generate the stage-discharge curve for the cross-section using Manning’s equation,

$$Q = \frac{1.49}{n} AR^{\left(\frac{2}{3}\right)} S^{\frac{1}{2}}, \dots\dots\dots [J.2]$$

in which Q represents the flow rate (cfs) at depth ‘y’ above the thalweg, ‘A’ is the cross-section area of the channel at depth ‘y’, ‘R’ represents the hydraulic radius at depth ‘y’ and ‘S’ is the longitudinal gradient of the channel (ft/ft). An example of a stage-discharge curve is provided in Figure J.2;

Table J.5 Summary of Hydraulic and Sediment Parameters											
Reach No.	Rosgen Stream Type	Parameter									
		2 Year Flow Q <sub>2YR</sub> (cfs)	W/d Ratio	Width W <sub>BFL</sub> (ft)	Depth d <sub>BFL</sub> (ft)	Flow Q <sub>BFL</sub> (cfs)	Base B (ft)	Wetted Perimeter P (ft)			
1	C3	8.9	3.00	3.00	1.00	4.76	2.00	4.24			
2	B3	9.54	3.23	2.75	0.85	5.10	1.90	3.80			
3	C3	10.1	2.87	2.83	0.99	5.40	1.85	4.06			
Reach No.	Parameter										
	Bed Material Mean Particle Size		Area	Hydraulic Radius	Slope	Velocity	Riparian Vegetation Type				
	<sup>50</sup> (in)	<sup>84</sup> (in)	A <sub>BFL</sub> (ft <sup>2</sup> )	R (ft)	S (ft/ft)	v (fps)					
1	2.8	3.3	2.50	0.590	.00385	1.90	Woody				
2	5.1	7.5	1.99	0.521	.0142	2.57	Woody				
3	3.7	5.2	2.32	0.570	.00794	2.35	Woody				
Reach No.	Parameter										
	Bank Material Composition					Critical Shear Stress		Depth of Stratigraphic Unit h (ft)	Excess Boundary Shear Stress τ <sub>CRT</sub> (lbs/ft <sup>2</sup> )		
	Soil Class		Soil Consistence Test			Bank (*)	Bed τ <sub>CRT</sub> (lbs/ft <sup>2</sup> )		Bank	Bed	
	Class	Unit No.	X1	X2	X3	SCOR E	τ <sub>CRT</sub> (lbs/ft <sup>2</sup> )	h (ft)			
1	SiLm	1	1	2	1	4	0.120	0.548	0.36<h≤1.00	0.057	-0.334
	SiSa	2	0	0	1	1			0.10<h≤0.36		
	CoGr	3	N/a	N/a	N/a	N/a			0.0<h≤0.10		
2	CoBo	1	N/a	N/a	N/a	N/a	0.573	1.206	0.39<h≤0.85	-0.016	-0.526
	GrCo	2	N/a	N/a	N/a	N/a			0.0<h≤0.39		
3	SiLm	1	2	1	3	6	0.329	0.878	0.32<h≤0.99	0.03	-0.446
	SiCl	2	2	2	2	6			0.12<h≤0.32		
	SiCl	3	2	3	2	7			0.0<h≤0.12		

(\*) Least resistant lower bank stratigraphic unit corresponding to the zone of secondary maximum boundary shear stress.

- The dominant discharge (Q<sub>GEO</sub>) is determined from the stage-discharge curve and field estimate of bankfull stage (d<sub>BFL</sub>). For Reach 1 in this example, d<sub>BFL</sub>=1.0 ft, consequently Q<sub>GEO</sub>=4.76 cfs (Figure J.2). This procedure is repeated for each cross-section within the reach and the flow rate most common to all cross-sections is adopted as the geomorphic referenced estimate of the dominant discharge. If a wide disparity exists between estimates of (Q<sub>GEO</sub>) than the determination of slope, Manning's 'n' value and the geomorphic indicators of bankfull stage are revisited to determine if a miss-interpretation of the data or an error in calculations has occurred.



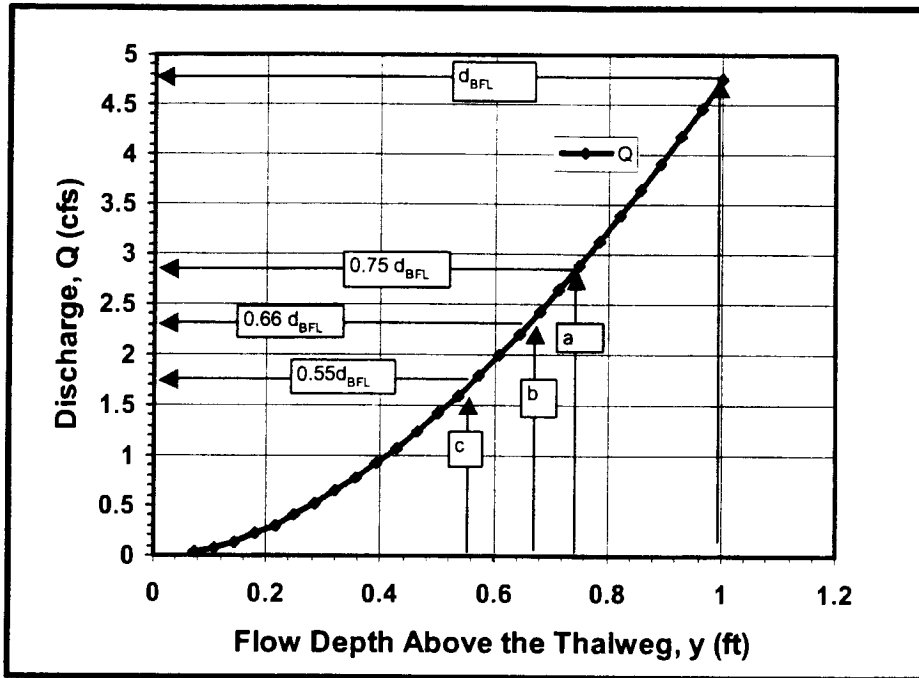

Figure J.2 Stage-Discharge Curve for Reach 1 Downstream of the Proposed Development

**Estimate of Bed Material Critical Shear Stress**

8. Critical shear stress is estimated for the  $\phi_{84}$  particle size value of the bed material using procedures such as:
  - (1) The modified Shield's equation (Vanoni, 1977), or
  - (2) Various empirical relations (from the literature) that express critical shear stress as a function of particle size, one such is Eqn J.3 proposed by Lane (1955)

$$(\tau_{CRT})_{BED} = 0.164\phi_{84} \dots \dots \dots [J.3]$$

in which  $\phi_{84}$  is the particle size for which 84% of the materials are finer (inches) and  $\tau_{CRT}$  represents the critical shear stress (lbs/ft<sup>2</sup>). Applying Eqn, [J.3] :

$$(\tau_{CRT})_{BED} = 0.164\phi_{84} = 0.164 (3.34 \text{ in}) = 0.548 \text{ lbs/ft}^2$$

at the Master cross-section (Reach 1);

**Estimate of Instantaneous Bed Shear Stress**

9. A stage-shear stress curve is generated for the Master cross-section using DuBoy's relation for average shear stress and a channel shape adjustment factor proposed by Lane (1955) as follows:

$$\tau_0 = k_s \rho g (d - d_f) S \dots \dots \dots [J.4]$$

and,

$$k_b = 0.000547\left(\frac{B}{d}\right)^3 - 0.0121\left(\frac{B}{d}\right)^2 + 0.092\left(\frac{B}{d}\right) + 0.75, \dots \dots \dots [J.5]$$

in which  $\tau_0$  represents the instantaneous boundary shear stress at point 'P' on the bed (lbs/ft<sup>2</sup>),  $k_b$  is a channel shape adjustment factor (dimensionless; Fig. J.3),  $\rho$  is the density of the sediment-water mixture being conveyed by the channel (62.4 lbs/ft<sup>3</sup>), 'g' is acceleration due to gravity (32.2 ft/s<sup>2</sup>), 'd' is the depth of the flow above the thalweg (ft),  $d_p$  is the depth of flow above the thalweg at point 'P' (ft), 'S' represents the longitudinal gradient of the flow at depth 'd' and 'B' is the bottom width of the channel (assuming a trapezoidal configuration). In this design case, a mapping of the isovels through the Master cross-section indicates that the point of maximum boundary shear stress occurs at the thalweg. Since the thalweg is the deepest part of the channel, the term  $d_p=0$  in Eqn. J.4. A stage-shear stress curve for Reach 1 is illustrated in Figure J.4. Note that the units for  $\tau_0$  are reported in lbs/ft<sup>2</sup> to be consistent with the estimate of critical shear stress reported in Task 8. To obtain units of lbs/ft<sup>2</sup> remove 'g' from Eqn. J.4.

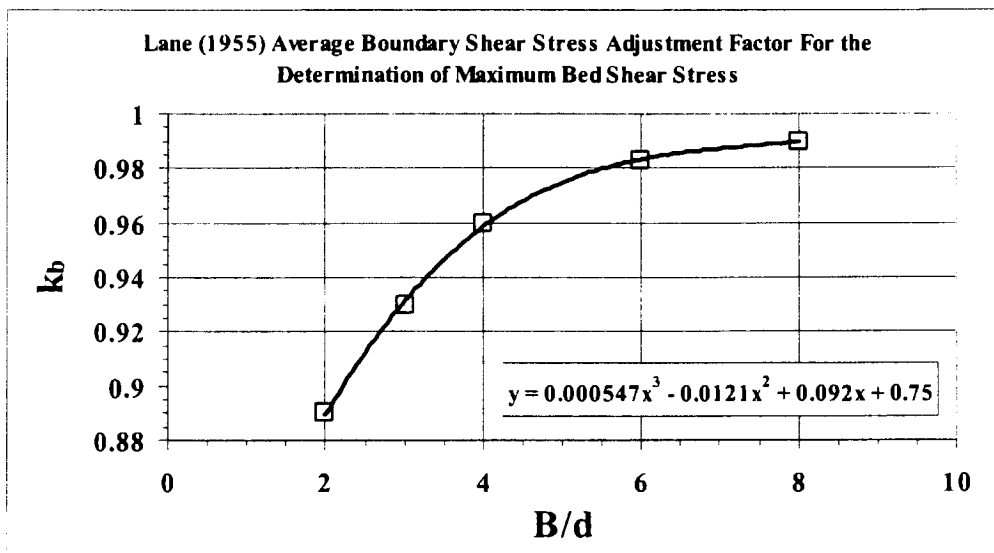
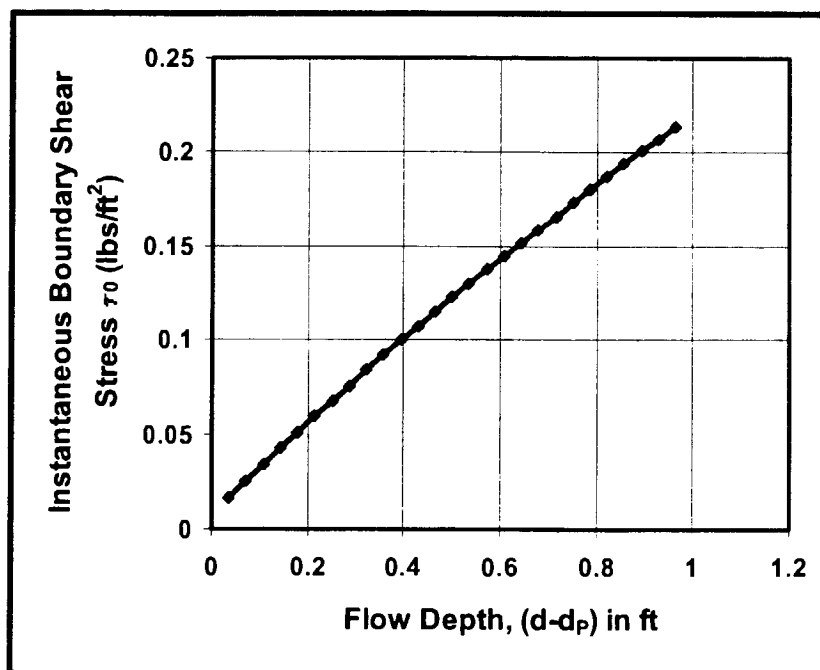

Figure J.3 Determination of  $k_b$  for the Adjustment of Average Boundary Shear Stress For Variations in Channel Shape Assuming A Trapezoidal Channel Cross-Section Configuration



**Figure J.4. Stage-Shear Stress Curve for Reach 1 (Master Cross-section): Bed Station.**

#### **Estimate the Sediment Referenced Dominant Discharge**

10. The stage-shear stress curve is used to determine the depth of flow at which the boundary shear stress on the bed is equal to the critical shear stress of the  $\phi_{84}$  particle size fraction. This depth is transformed into an estimate of flow rate from the stage-discharge curve (Task 5 above), providing a second, independent estimate of the dominant discharge ( $Q_{SED}$ ). This calculation also provides a basis for determination of the sensitivity of the bed material to an alteration in the sediment-flow regime. This assessment is described in Task 21 below;

#### **Estimate The Flow Recurrence Interval of the Referenced Dominant Discharge**

11. A flow time series is generated using:
  - (1) Flow gauge data if available,
  - (2) A continuous hydrologic model to generate a synthetic flow time series of 6 to 13 years in length.
12. The flow time series is used to derive a flood frequency curve from which a third independent estimate of the dominant discharge ( $Q_{RI}$ ) is determined as the flow having a recurrence interval between 1 and 2 years (average  $RI=1.5$  years);

**Finalize the Estimate of Dominant Discharge**

13. The three estimates of dominant discharge are compared for consistency. If consistent (e.g. the range is equal to or less than 20% of the mean), then the mean value of the dominant discharge can be accepted with a higher degree of confidence

**Step 3. Determine the Sensitivity of the Boundary Materials**

**A) Sensitivity of the Bed Material**

14. Using the stage-shear stress relationship developed in Task 9 and the estimate of flow depth ( $d_{BFL}$ , Task 10) from the dominant discharge (Task 13), determine the boundary shear stress  $(\tau_0)_{BED}$  being applied to the bed at point ‘P’ at the dominant discharge. Point ‘P’ is located on the bed within the zone of maximum boundary shear stress. In this example the value of maximum instantaneous boundary shear stress at a depth of  $d_{BFL} = 1.0$  ft was found to be  $(\tau_0)_{BED} = 0.214$  lbs/ft<sup>2</sup> at the Master cross-section in Reach 1 (Figure J.4). Similarly, for Reaches 2 and 3 the maximum value of instantaneous boundary shear stress was found to be  $(\tau_0)_{BED} = 0.680$  and  $0.432$  lbs/ft<sup>2</sup> respectively.
15. Compute the value of  $(\tau_c)_{BED}$  for the Master cross-section knowing  $(\tau_0)_{BED}$  and  $(\tau_{CRT})_{BED}$  as,

$$(\tau_c)_{BED} = (\tau_0 - \tau_{CRT})_{BED}, \dots \dots \dots [J.6]$$

in which  $(\tau_c)_{BED}$  represents the effective boundary shears stress,  $\tau_0$  is the instantaneous boundary shear stress at the dominant discharge and  $\tau_{CRT}$  is the critical shear stress of the bed material at point ‘P’.

16. Repeat the bed shear stress analysis for all Master cross-sections in all reaches of “like” morphology.
17. Compare the value of  $(\tau_c)_{BED}$  for all Master cross-sections through the study reach and select the Master cross-section for which the value of  $(\tau_c)_{BED}$  is greatest. The reach represented by the Master cross-section having the highest value of  $(\tau_c)_{BED}$  is referred to as the “Control Reach”.

In this example, effective boundary shear stress on the bed was found to range from between -0.526 and -0.334 (Table J.5). The negative values infer that the channel bed is armored and the bed material is mobile under flood flow events in excess of the dominant discharge. However, of the three Master cross-sections the value of  $(\tau_c)_{BED}$  was greatest for Reach 1, consequently, Reach 1 was identified as the “Control Reach”.

**B) Sensitivity of the Bank Material**

18. The bank material for the “Control Reach” is classified according to soil type for each stratigraphic unit using:
  - (1) Soil consistency tests; or
  - (2) Particle size analysis and Atterberg Limits.

In this example the bank materials were mapped and differentiated into stratigraphic units as summarized for the three reaches in Table J.5. The soil consistency test results determined using standard soil classification guidelines (as quantified by MacRae, 1991)), are summarized below and reported in Table J.5.

  - i) Assign a value for the stickiness of the material, e.g. not sticky, ( $X1=0$ ) to extremely sticky ( $X1=4$ ),
  - ii) Assign a value for the plasticity of the material, e.g. not plastic ( $X2=0$ ) to extremely plastic ( $X2=4$ ),
  - iii) Assign a value for the firmness of the material, e.g. loose, no structure ( $X3=0$ ) to

stiff (X4=4).

(3) Sum the consistency test values,

$$SCORE = \sum_{i=1}^3 x_i, \dots \dots \dots [J.7]$$

in which SCORE represents the sum of the values assigned for stickiness, plasticity and firmness.

19. Construct stage-shear stress curves for selected bank stations approximated by 0.25d<sub>BFL</sub>, 0.33d<sub>BFL</sub>, 0.4d<sub>BFL</sub>. More than one bank station may be required in a stratigraphic unit depending upon the thickness of the unit. The curves may be approximated as follows:

$$\tau_o = k_s (\rho g (d - d_p) S), \dots \dots \dots [J.8]$$

in which k<sub>s</sub> is a correction factor for points on the channel bank determined as a function of channel shape (see Eqn. J.9, Figure J.5), 'd' is the depth of flow (ft), ρ is the density of water (62.4 lbs/ft<sup>3</sup>), 'g' is acceleration due to gravity (32.2 ft/s<sup>2</sup>) and d<sub>p</sub> is the depth of flow at the elevation of the boundary station (ft).

$$k_s = 0.7236 \left( \frac{B}{d} \right)^{0.0241}, \dots \dots \dots [J.9]$$

in which B is the channel bottom (ft) width and 'd' is the depth of flow (ft). Note, to obtain units of lbs/ft<sup>2</sup> remove the constant 'g' from Eqn. J.8.

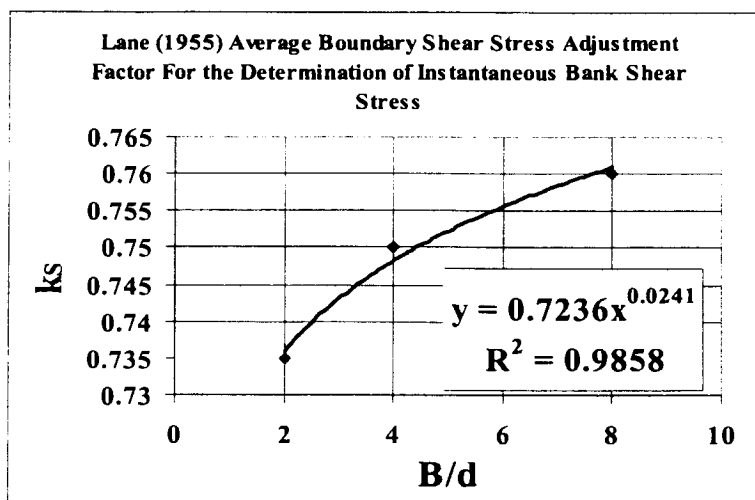

Figure J.5 Adjustment Factor  $k_s$  for Bank Shear Stress For Channels Approximating a Trapezoidal Shape

20. Estimate the critical shear stress ( $\tau_{CRT}$ ) within each stratigraphic unit using available empirical relationships. These relations are typically based on percent silt and clay content, degree of compaction, particle size (Vanoni, 1977) or the SCORE value (MacRae, 1991);
21. Compute the excess boundary shear stress for each bank station at a flow depth of between 0.6 and 0.75 feet by reading the boundary shear stress off the stage-shear stress curve for each boundary station and subtracting the critical shear stress as described in DuBoy's relation,

$$(\tau_e)_{BNK} = (\tau_0 - \tau_{CRT})_{BNK} \dots \dots \dots [J.10]$$

in which  $(\tau_e)_{BNK}$  represents the excess boundary shear stress (lbs/ft<sup>2</sup>) at the selected boundary station (P),  $\tau_0$  is the instantaneous boundary shear stress (lbs/ft<sup>2</sup>) at any specified depth of flow at point P and  $\tau_{CRT}$  represent the critical shear stress (lbs/ft<sup>2</sup>) of the boundary material at point P.

22. Compare the estimates of excess boundary shear stress  $(\tau_e)_{BNK}$  at each bank station and select that station having the highest value of  $(\tau_e)_{BNK}$  as the bank station controlling bank response (controlling stratigraphic unit) to a change in the flow regime. Using the guidelines presented in Table J.6 determine channel sensitivity to an alteration in the sediment-flow regime and the corresponding Over Control (OC) curve and Inflection Point

Table J.6 General Guidelines for the Application of the DRC Approach Based on Bank Material Sensitivity Using SCORE Values							
BANK SENSITIVITY		BED SENSITIVITY				DRC PARAMETERS	
Excess Shear Stress ( $\tau_c$ ) <sub>BED</sub>	Sensitivity Class	Excess Shear Stress ( $\tau_c$ ) <sub>BNK</sub>	Bank Resistance		Sensitivity Class	Over Control Multiplier $R_{OC}$	Inflection Point
			Soil Class	SCORE			
<0	L	<0	Very Stiff	N/a	L	1.0 - 0.9	a
		≈0	Stiff	10-12	ML	0.9 - 0.7	a
			Firm	7-9	M	0.7 - 0.5	b
			Soft	≤6	H	0.5 - 0.2	c
>0	N/a			<b>0.5 - 0.2</b>	<b>c</b>		
≈0	ML	<0	N/a			0.9 - 0.7	a
		≈0	Stiff	10-12	ML	0.9 - 0.7	a
			Firm	7-9	M	0.7 - 0.5	b
			Soft	≤6	H	0.5 - 0.2	c
	>0	N/a			0.5 - 0.2	c	
	M	<0	N/a			0.7 - 0.5	b
		≈0	Stiff	N/a		0.7 - 0.5	b
			Firm	7-9	M	0.7 - 0.5	b
			Soft	≤6	H	0.5 - 0.2	c
	>0	N/a			0.5 - 0.2	c	
H	N/a			0.5 - 0.2	c		
>0	H	N/a			0.5 - 0.2	c	

The multiplier ( $R_{OC}$ ) in Table J.6 is used in the following manner:

- a) The 2 year peak flow attenuation technique is used to derive the stage-discharge curve for the erosion control component of the SWM pond.
- b) A multiplier of unity is equivalent to the traditional 2-year peak flow attenuation approach.
- c) The multiplier is used to adjust the 2-year stage-discharge curve to account for differences in the erodability of the boundary materials. The adjustment is performed by multiplying each ordinate of the stage-discharge curve by  $R_{OC}$ . For stiff materials, the multiplier approaches unity ( $R_{OC} \rightarrow 1.0$ ). For very sensitive materials, the multiplier is between 0.2 and 0.3, which is equivalent to 80%OC to 70%OC respectively.

Bank materials may be grouped according to the SCORE value if the soil consistency tests apply (i.e. fine-grained material with few stones). For coarse-grained materials, resistance can be determined from observation of bank erosion following a high flow event. As an alternative the resistance of the coarse-grained stratigraphic unit can be inferred from bank form and shear stress distribution through comparison with adjoining strata of fine-grained material.

Finally, relations expressing critical shear stress as a function of particle size are available in the literature. Many of these relations were derived from flume experiments using disturbed material that has been re-compacted. These relations tend to underestimate the resistance of the material as it is observed in the field. Consequently, these relations should be employed with caution or corrected to account for root binding, imbrication, compaction and structurization.

**Step 4. Approximate the Elevation-Discharge Curve For the DRC Pond.**

The DRC outflow control structure can be constructed as set of pipes or nested weirs. This design example is for a nested, sharp crested weir.

Determine the stage-discharge curve for the flow rate having a recurrence interval of 2 years for the baseline land use condition. For this example, the baseline condition is the reforested land use scenario. The flow having a recurrence interval 2 years was determined previously as between 8.9 and 10.1 cfs for Reaches 1 through 3 respectively (Table J.5).

Construct the 2 year stage-discharge curve using an equation for sharp crested weirs with end contractions:

$$Q = C_e L_e h_e^{\left(\frac{3}{2}\right)} \dots\dots\dots [J.11]$$

in which, 'Q' represents the rate of flow (cfs), 'C<sub>e</sub>' is the effective weir coefficient (C=3.19, Brater and King, 1982), L<sub>e</sub> is the effective length of the weir (ft) and 'h<sub>e</sub>' is the effective depth of flow above the weir crest (ft). Set the invert of the weir at 628.0 ft. The terms L<sub>e</sub>, C<sub>e</sub> and h<sub>e</sub> are adjusted to account for losses due to end contractions (Brater and King, 1982). In this illustration it is assumed that the stage-volume curve has already been derived and that the approximate head at Q<sub>BFL</sub>=8.9 cfs is h=2.25 ft.

Re-arranging Eqn. J.11 and solving for 'L<sub>e</sub>' at Q=(Q<sub>2YR</sub>)<sub>PRE</sub>=8.9 cfs yields,

$$L_e = \frac{Q}{C_e h_e^{\left(\frac{3}{2}\right)}} = \frac{8.9}{3.19(2.25)^{\left(\frac{3}{2}\right)}} = 0.83\text{ft} \dots\dots\dots [J.12]$$

Compute the stage-discharge curve for the 2-year weir using Eqn. J.11 as illustrated in Figure J.6 (Q<sub>2YR</sub>, curve AB. This stage-discharge curve represents the rating curve for the 2-year post- to pre-development peak flow attenuation approach.



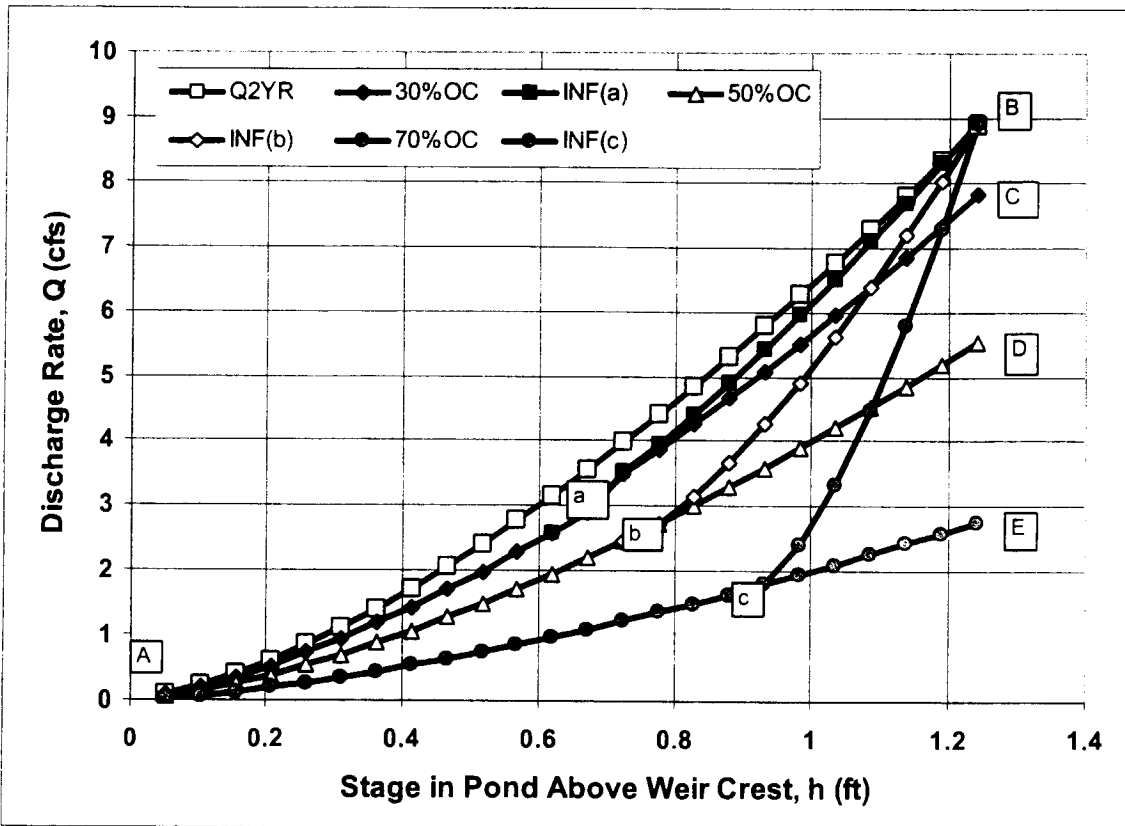

Figure J.6. The 2 Year Peak Flow Attenuation and DRC Rating Curves for 30%OC, 50%OC and 70%OC

Construct the DRC stage-discharge curve as follows:

- Determine the level of OC control and the inflection point from Table J.6.
  - Since  $(\tau_c)_{BED} < 0$  (Table J.5) then the bed is classified as “Low” sensitivity (shaded boxes in the first two columns of Table J.6);
  - The value of  $(\tau_c)_{BNK} > 0$  consequently, Row 3 of Column 3 (shaded box in Table J.6) was selected;
  - The bank material was classified as soft (SCORE=1), consequently, the 4<sup>th</sup> Row of Column 4 was chosen providing a range of  $R_{OC}$  between 0.5 and 0.2 with an inflection point at “c”. In this case  $R_{OC}=0.3$  was selected in accordance with the guidelines in Table J.6. Note: 70%OC means that the multiplier for the 2 year curve is  $R_{OC}=0.3$ .
  - The 70%OC curve (designated as curve AE in Figure J.6) is created by multiplying the ordinance of the 2 year stage-discharge curve ( $Q_{2YR}$  in Figure J.6) by the multiplier  $R_{OC}=0.3$ .
  - The inflection point (c) is determined using the guidelines provided in Table J.7.

Table J.7 Guidelines For Determination of the Flow Rate for the DRC Curve Inflection Point (Reach 1)					
Inflection Point	Ratio of Inflection Point Depth to Bankfull Depth $d_i/d_{BFL}$ (dim)	Bankfull Depth $d_{BFL}$ (ft)	Inflection Point Depth $d_i$ (ft)	Dominant Discharge $Q_{BFL}$ (cfs)	Flow Rate at Inflection Point $Q_i$ (cfs)
a	.75	1.0	.75	4.76	2.88
b	.67		.67		2.30
c	.55		.55		1.74

The point  $d_c=0.55$  ft,  $d_{BFL}=1.0$  ft, characterize the Control Reach, consequently the ratio,

$$\frac{d_c}{d_{BFL}} = \frac{0.55 \text{ ft}}{1.0 \text{ ft}} = 0.55, \dots \dots \dots [J.12]$$

- The flow rate at  $d_c/d_{BFL}=0.55$  was estimated from Figure J.6 to be  $Q_c=1.74$  cfs.
- Point (c) can be located on curve AE at a flow corresponding to  $Q_c=1.74$  cfs.
- The DRC stage-discharge curve follows the curve A(c)B in Figure J.6. For the purpose of illustration, the stage-discharge curves for 30%OC (inflection point (a)) and 50%OC (inflection point (b)) are also provided in Figure J.6.

**Step 5. Sizing the DRC Weir**

After establishing the DRC stage-discharge curve the next step is to size the DRC weir. This is done using a nested weir configuration as illustrated in Figure J.7. The equation for the nested weir can be approximated from Eqn. J.14 for sharp crested weirs as,

$$Q = \left( C_c L_c h_c^{\left(\frac{3}{2}\right)} \right)_{INSET} + \left( C_c (L_c^* - L_c) (h_c^* - h_c)^{\left(\frac{3}{2}\right)} \right) \dots \dots \dots [J.14]$$

in which Q represents the discharge from the nested weir, 'C<sub>c</sub>' is a coefficient (3.19) adjusted to account for end contractions, L<sub>c</sub> is the length of the inset weir, h<sub>c</sub> represents the height of the inset weir where  $0 \leq h_c \leq h_2$  (h<sub>2</sub> represents the total height of the nested weir) and h<sub>c</sub><sup>\*</sup> is the depth of flow through the nested weir above the inset weir ( $h_c \leq h_c^* \leq h_2$ ).

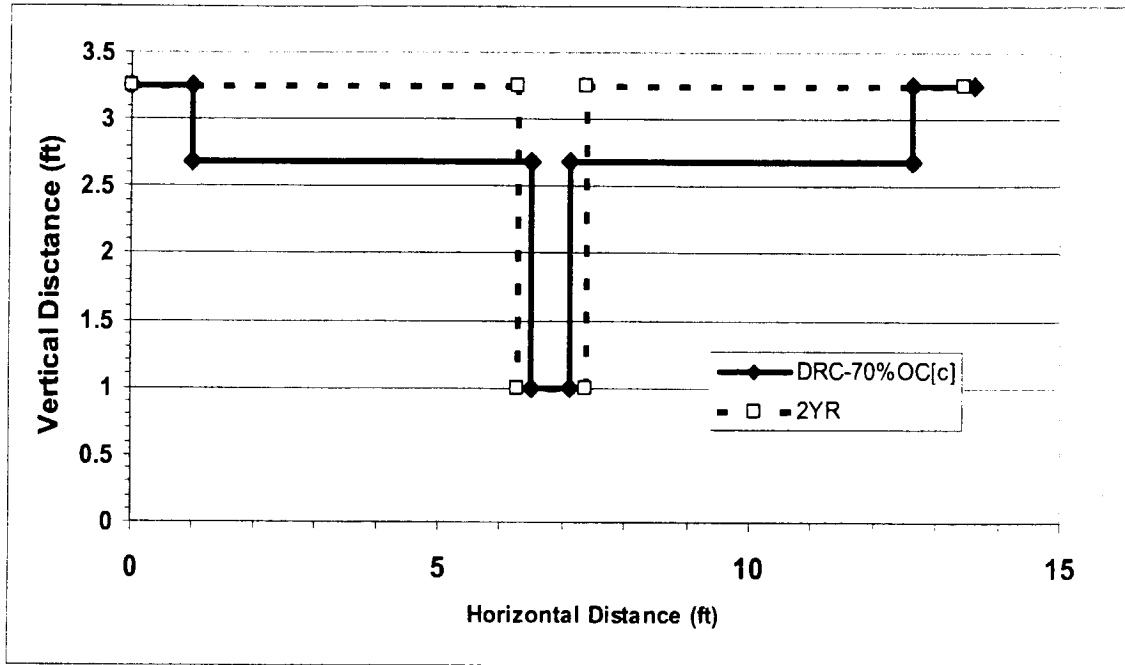

Figure J.7 Comparison of the 70% OC DRC Weir with Inflection Point at [c] and the Traditional 2-year Peak Flow Attenuation Weir

Solving Eqn. D.14 for results in the dimensions and flow values reported in Table J.8.

Table J.8. Summary of Dimensions and Flow Characteristics For a Nested DRC Weir: Reach 1				
Parameter	DRC Weir			2 Year Weir
	Inflection Point (a)	Inflection Point (b)	Inflection Point (c)	
$L_c$ (ft)	1.77	1.00	0.62	N/A
$h_c$ (ft)	0.67	0.78	0.93	
$Q_1$ at $h_c$ (cfs)	2.89	2.21	1.74	
$L_c$ (ft)	0.80	4.32	11.0	0.83
$h_2$ (ft)	2.25			
$Q$ at $h_2$ (cfs)	8.94			

Parameters in Table J.8 are defined in the preceding text.

Note: the weir dimensions for DRC stage discharge curves 30%OC (inflection point 'a') and 50%OC (inflection point 'b') are provided for comparison with the selected option (inflection point 'c').

# Appendix K

R0080545

New York State Stormwater Management Design Manual

**Miscellaneous Design Schematics for Compliance with Performance Criteria**

- Figure K-1: Trash Rack for Low Flow Orifice
- Figure K-2: Expanded Trash Rack Protection for Low Flow Orifice
- Figure K-3: Internal Control for Orifice Protection
- Figure K-4: Observation Well for Infiltration Practices
- Figure K-5: On-line Versus Off-line Schematic
- Figure K-6: Isolation/Diversion Structure
- Figure K-7: Half Round CMP Hood
- Figure K-8: Half Round CMP Weir
- Figure K-9: Concrete Level Spreader
- Figure K-10: Baffle Weir for Cold Climates
- Figure K-11: Hooded Outlet with Hood Below Ice Layer
- Figure K-12: Shallow Angle Trash Rack to Prevent Icing

Figure K.1 Trash Rack Protection for Low Flow Orifice

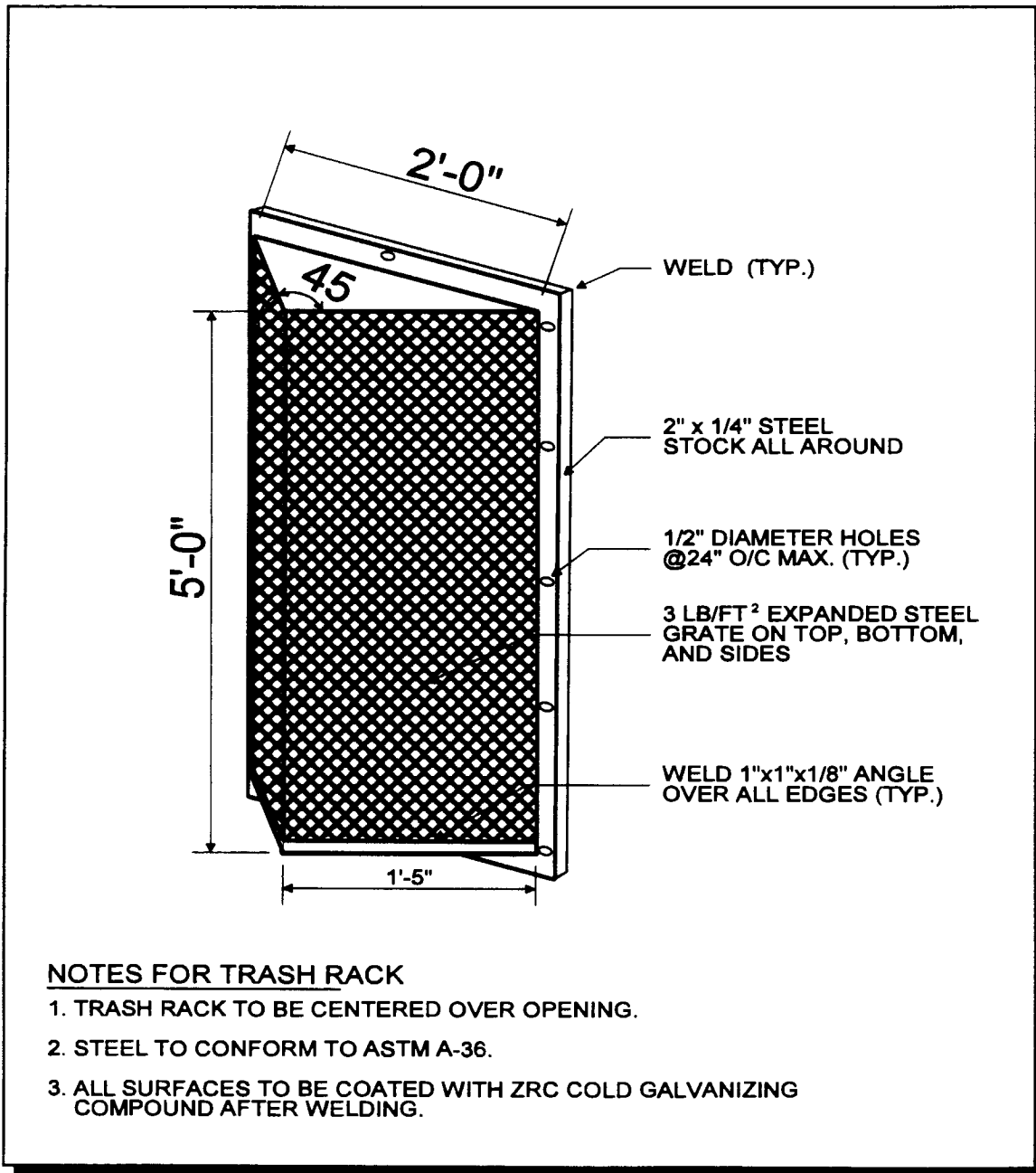

Figure K.2 Expanded Trash Rack Protection for Low Flow Orifice

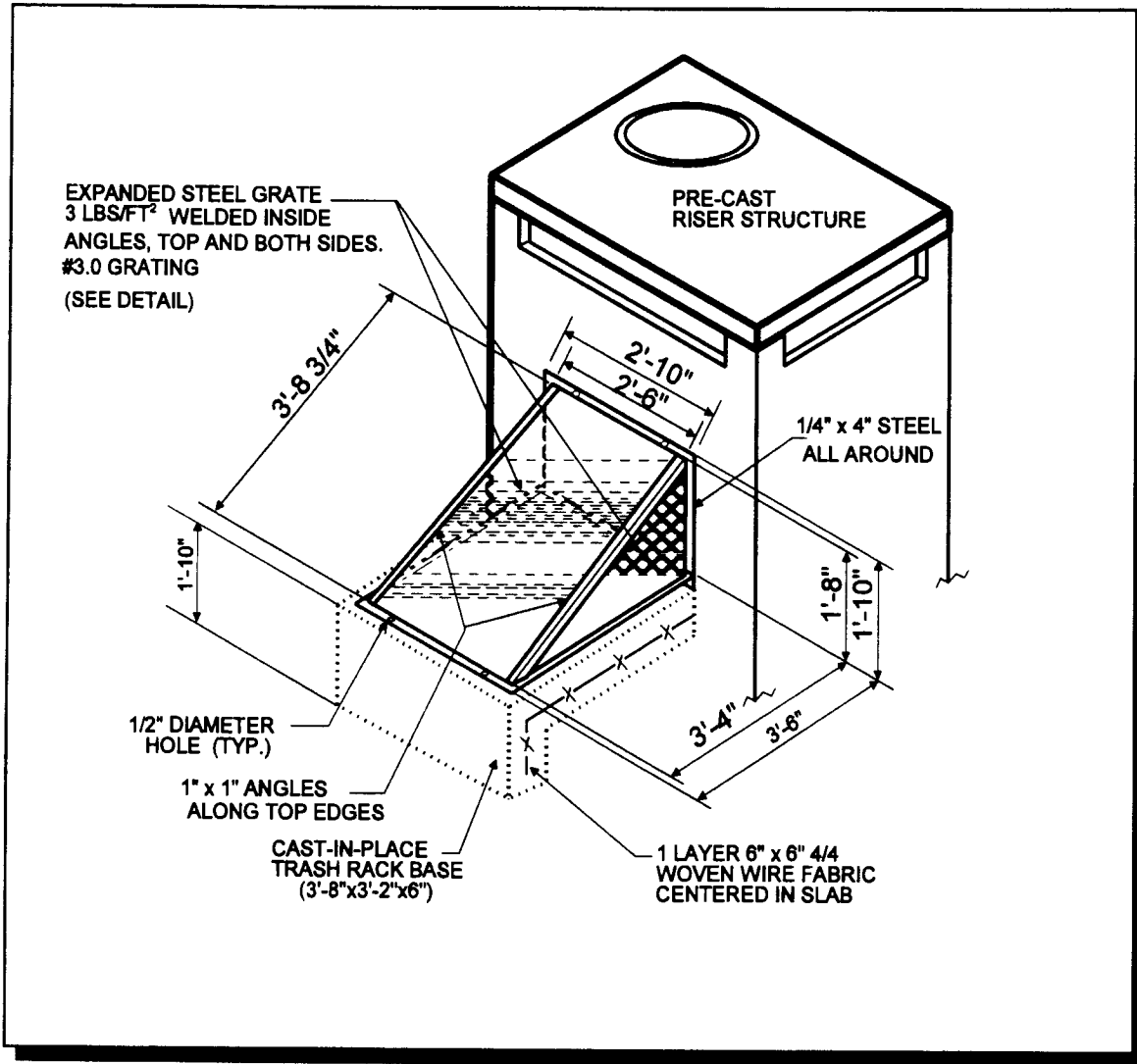

Figure K.3 Internal Control for Orifice Protection

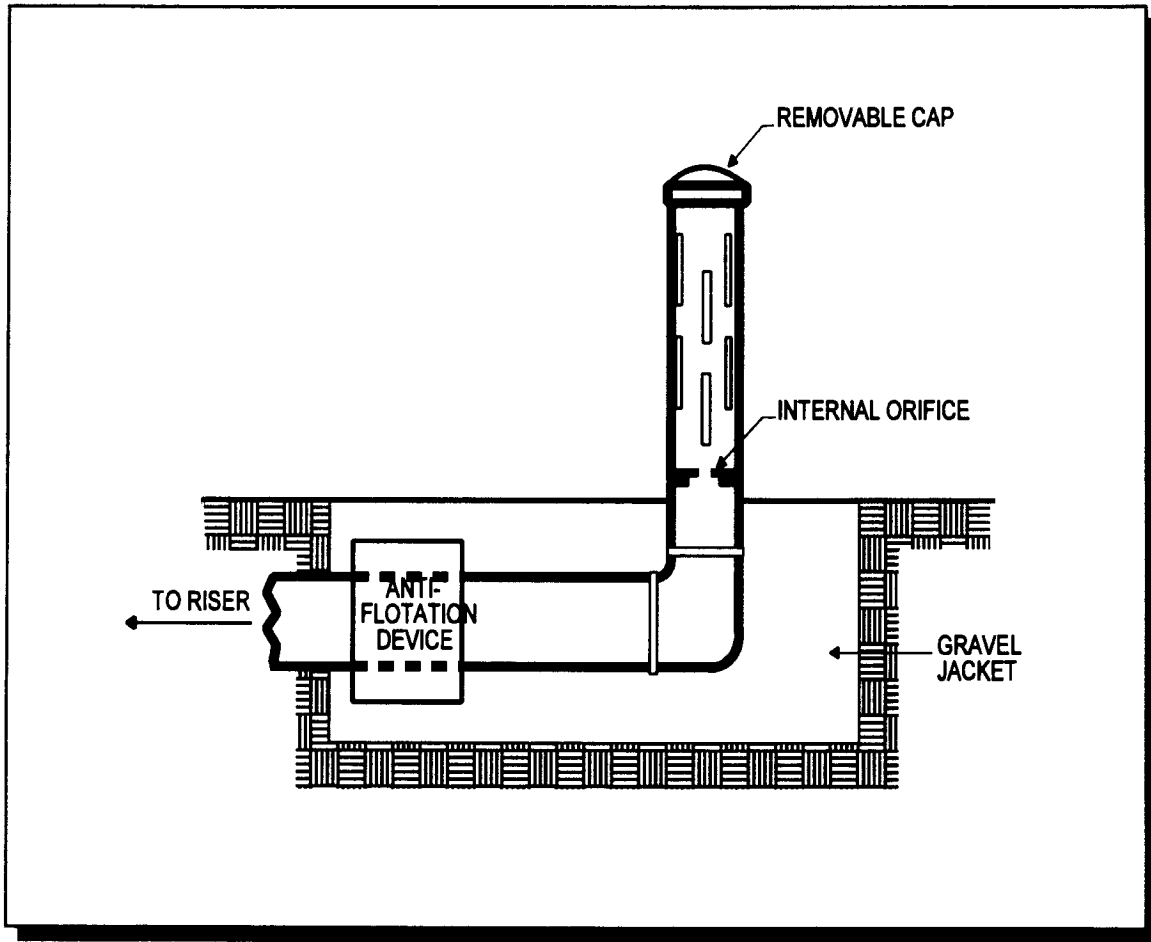



Figure K.4 Observation Well for Infiltration Practices

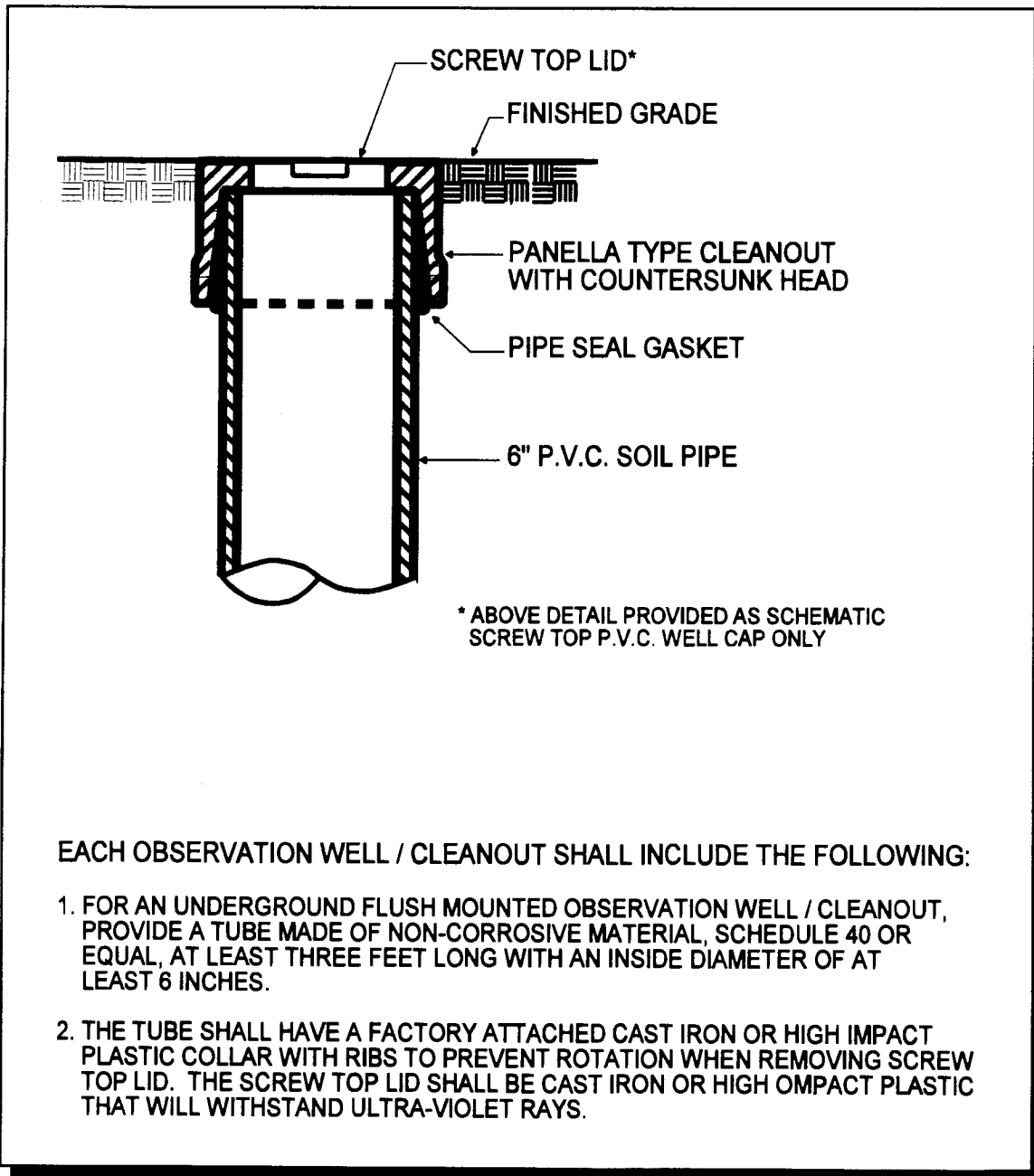

Figure K.5 On-Line Versus Off-Line Schematic

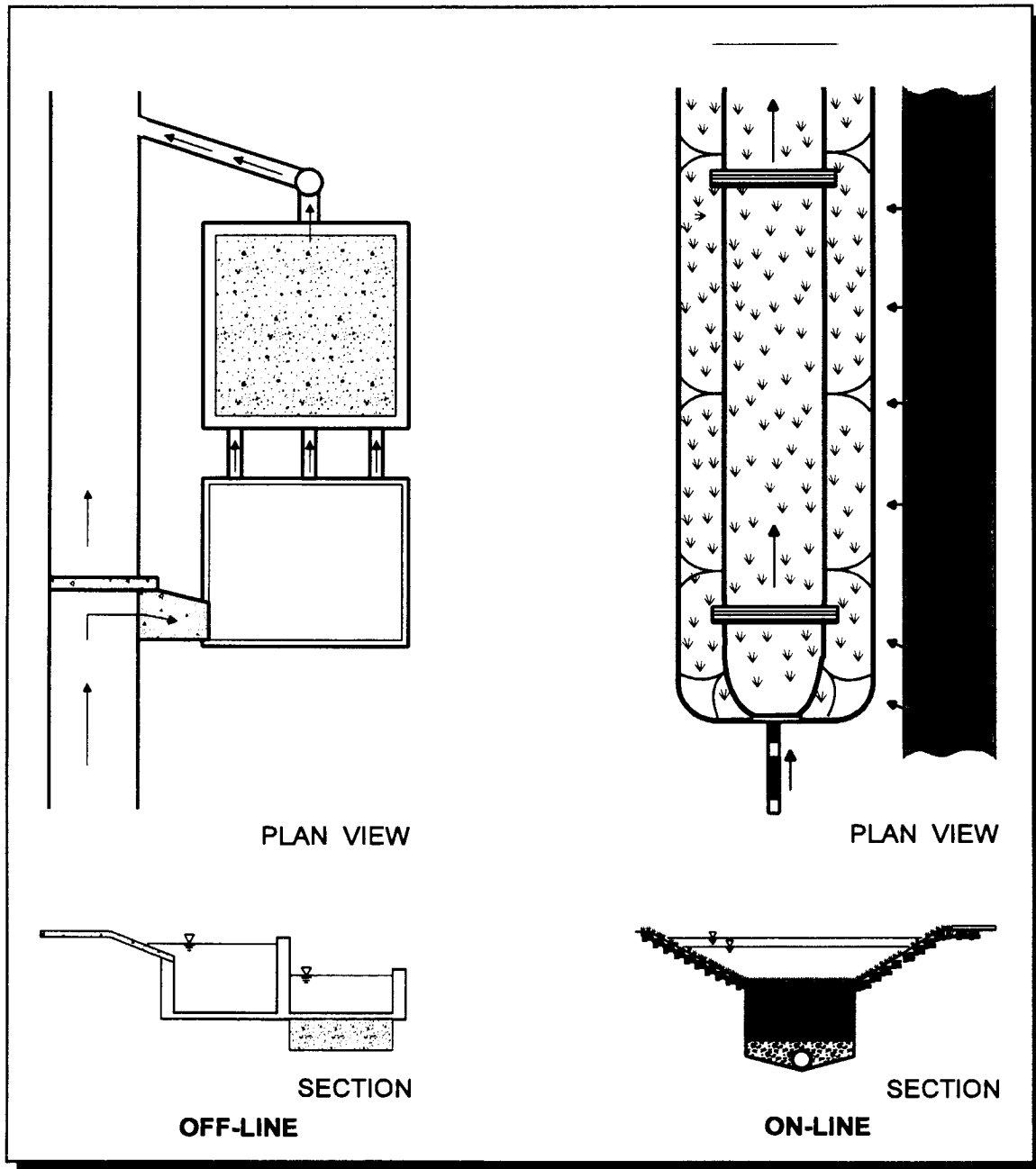

Figure K. 6 Isolation Diversion Structure

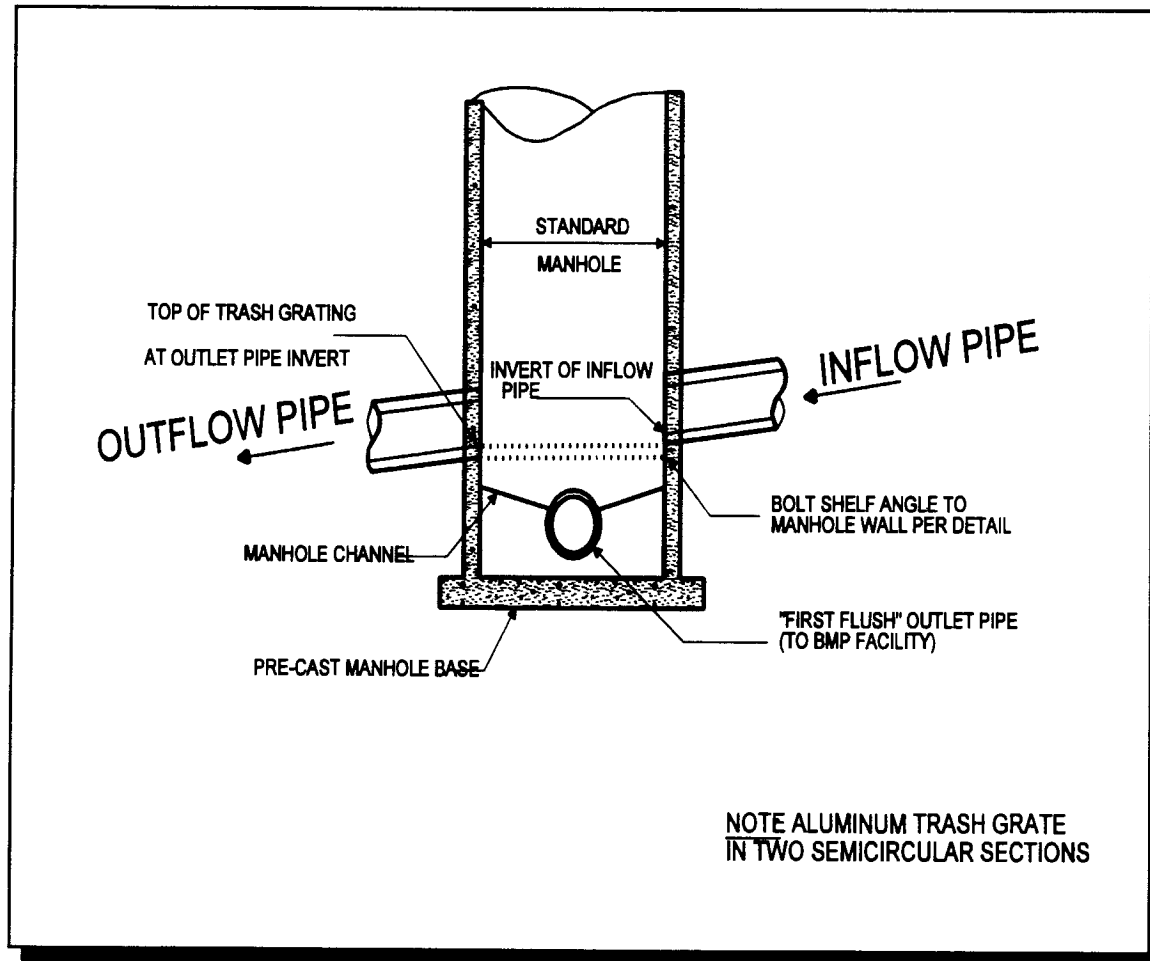

Figure K.7 Half Round CMP Hood

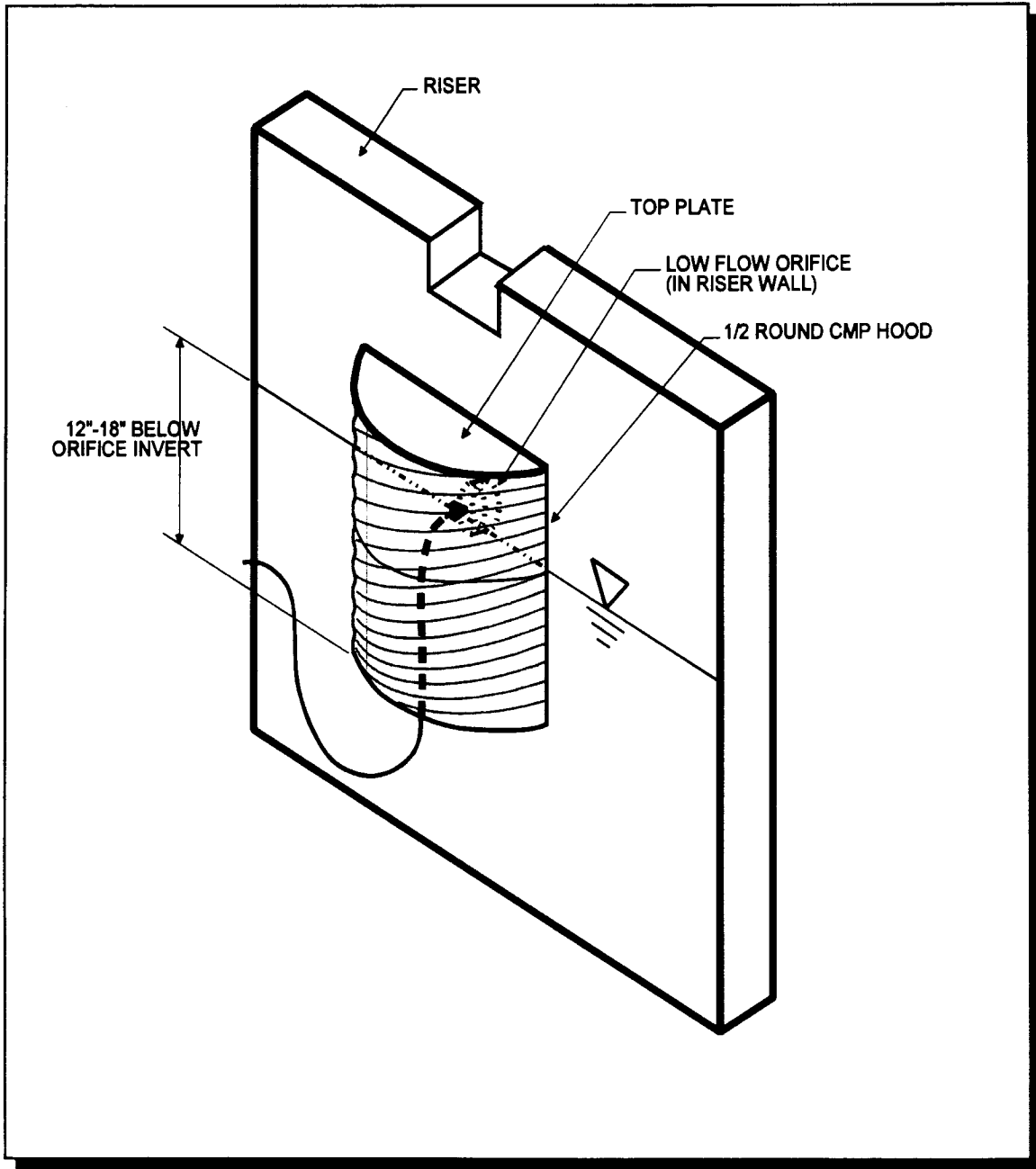

Figure K.8 Half Round CMP Weir

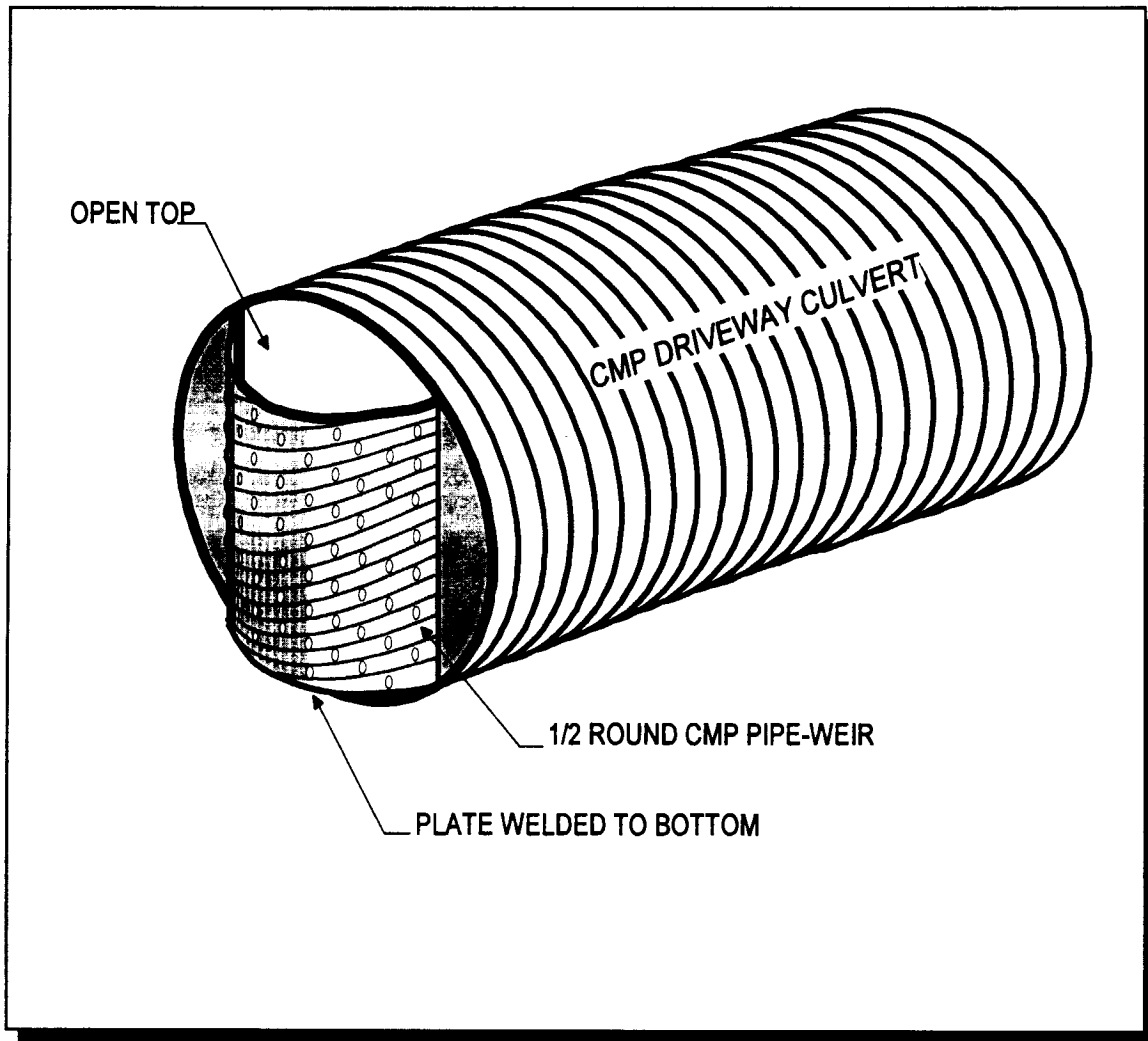

Figure K.9 Concrete Level Spreader

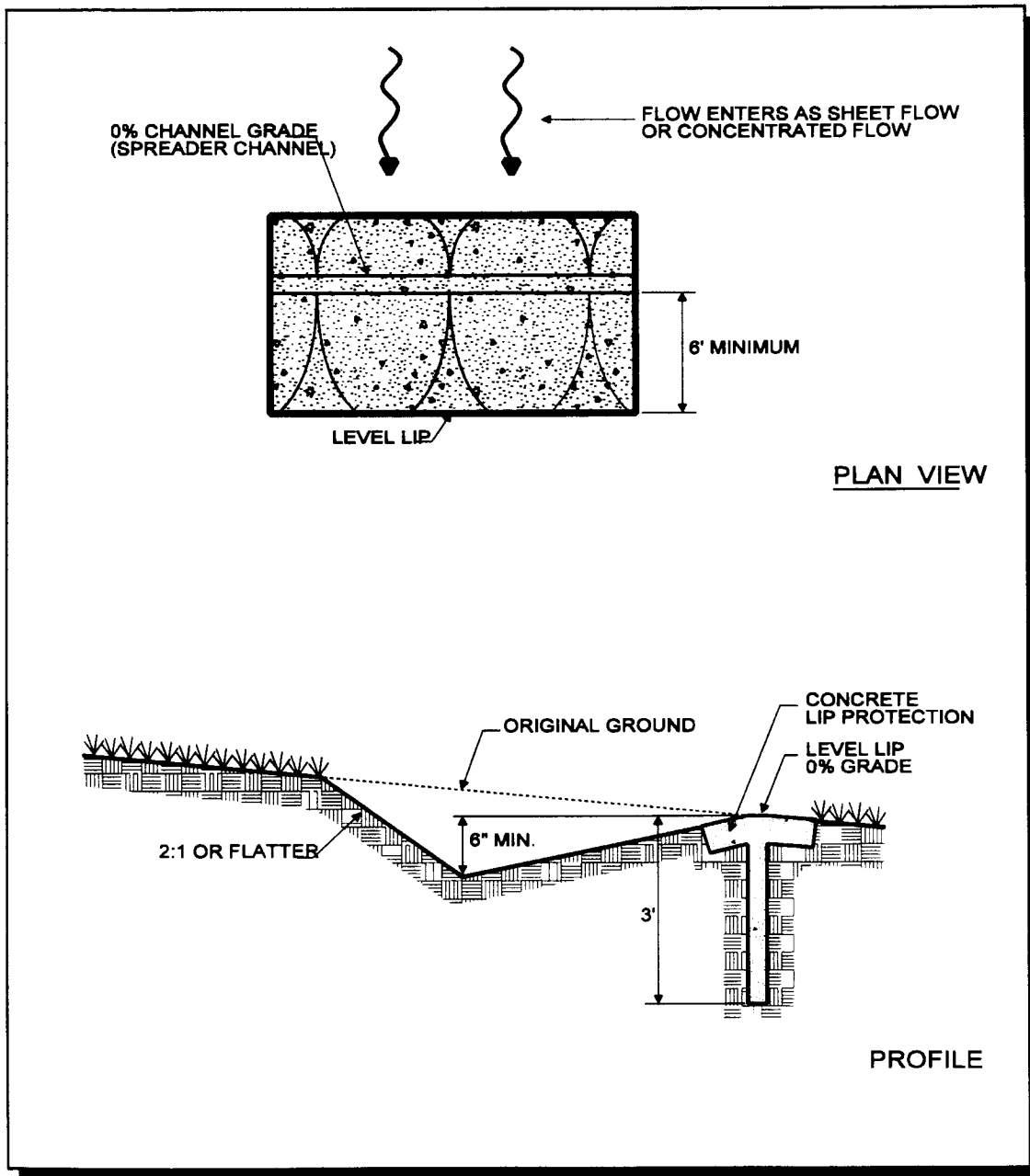

Figure K.10 Baffle Weir for Cold Climates

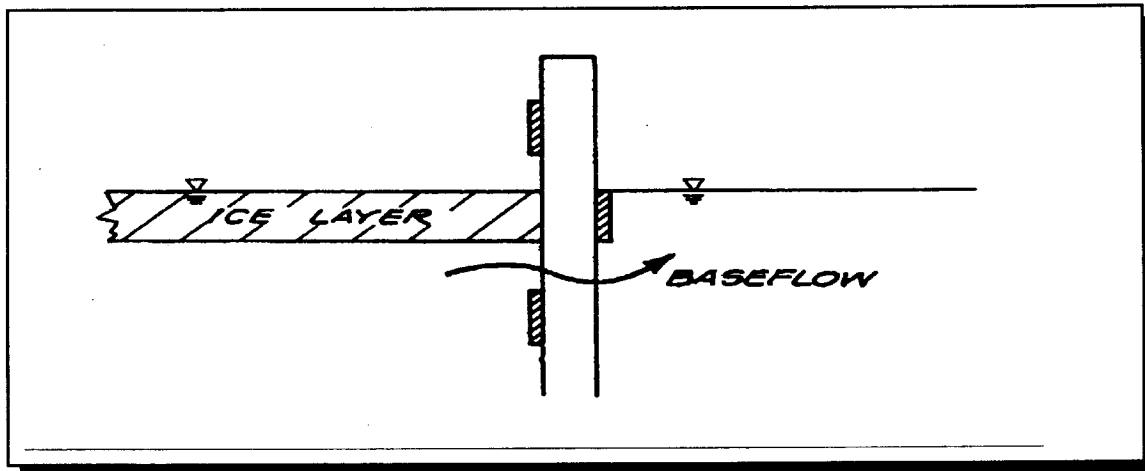

Figure K.11 Hooded Outlet with Hood Below Ice Layer

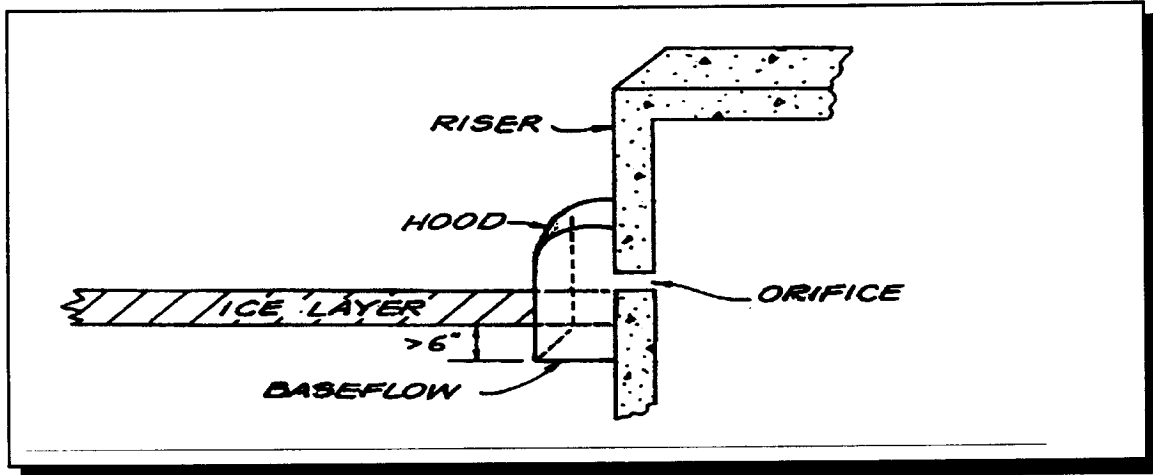
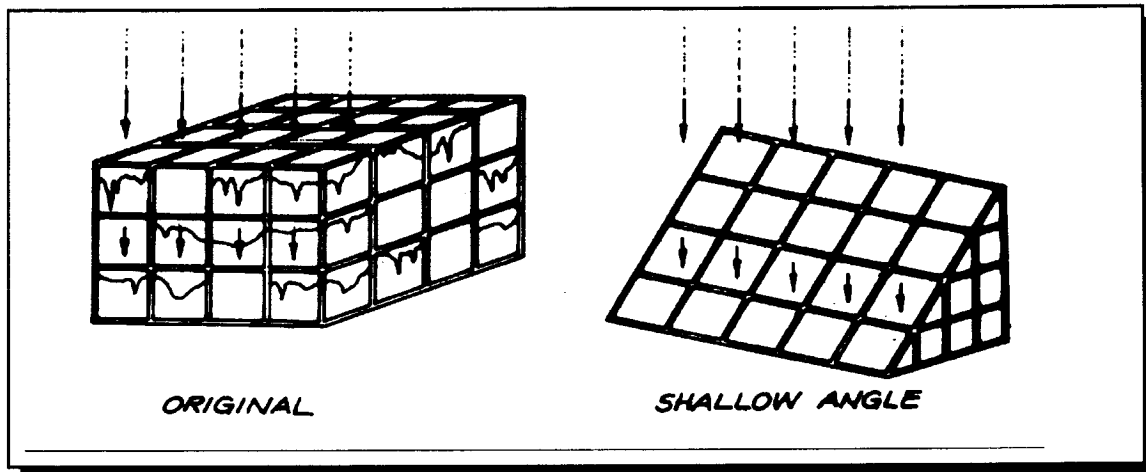



Figure K.12 Shallow Angle Trash Rack to Prevent Icing



# Appendix L

New York State Stormwater Management Design Manual

R0080559

## Appendix L: Critical Erosive Velocities for Grass and Soil

### Velocity

Maximum permissible velocities of flow in vegetated channels absent of permanent turf reinforcement matting shall not exceed the values shown in the following table:

**Table L.1 Permissible Velocities for Channels Lined with Vegetation**

Channel Slope	Lining	Permissible Velocity <sup>1</sup> (ft/sec)
0-5%	Reed canarygrass Tall fescue Kentucky bluegrass	5
	Grass-legume mixture	4
	Red fescue Redtop Serices lespedeza Annual lespedeza Small grains	2.5
5-10%	Reed canarygrass Tall fescue Kentucky bluegrass	4
	Grass-legume mixture	3
Greater than 10%	Reed canarygrass Tall fescue Kentucky bluegrass	3

Source: Soil and Water Conservation Engineering, Schwab, *et al.*

For vegetated earth channels having permanent turf reinforcement matting, the permissible flow velocity shall not exceed 8 ft/sec. Turf reinforcement matting shall be a machine produced mat of nondegradable fibers or elements having a uniform thickness and distribution of weave throughout. Matting shall be installed per manufacturer's recommendations with appropriate fasteners as required. Examples of acceptable products include but are not limited to:

- North American Green "C350" or "P300"
- Greenstreak "PEC-MAT"
- Tensar "Erosion Mat"

<sup>1</sup> For highly erodible soils, permissible velocities should be decreased 25%. An erodibility factor (K) greater than 0.35 would indicate a highly erodible soil. Erodiability factors (K-factors) can be obtained from local NRCS offices.

Manning's n value

The roughness coefficient,  $n$ , varies with the type of vegetative cover and flow depth. At very shallow depths, where the vegetation height is equal to or greater than the flow depth, the  $n$  value should be approximately 0.15. This value is appropriate for flow depths up to 4 inches typically. For higher flow rates and flow depths, the  $n$  value decreases to a minimum of 0.03 for grass channels at a depth of approximately 12 inches. The  $n$  value must be adjusted for varying flow depths between 4" and 12" (see Figure L.1).

**Figure L.1 Manning's n Value with Varying Flow Depth (Source: Claytor and Schueler, 1986)**

